

KB8141

GENERAL PURPOSE
HIGH ISOLATION VOLTAGE
HIGH SENSITIVITY
PHOTOCOUPLER SERIES

FEATURES

1. AC Input.
2. High current transfer ratio.(CTR:Min 600%,at $I_F = \pm 1\text{mA}$, $V_{CE} = 2\text{V}$)
3. High isolation voltage between input and output (Viso=5000 Vrms)
4. Compact dual-in-line package
KB8141: 1-channel type
5. Recognized by UL and CUL, file NO. E225308
6. Rohs Compliant.

DESCRIPTION

1. The KB8141 (1-channel) is optically coupled isolators containing two GaAs light emitting diode and a darlington silicon phototransistor.
2. The lead pitch is 2.54mm

APPLICATIONS

1. Computer terminals
2. Registers, copiers, automatic vending machines
3. System appliances, measuring instruments
4. Programmable logic controller
5. Signal transmission between circuits of different potentials and impedances

KB8141

* PACKAGE DIMENSIONS (UNIT: mm)

DIP Type

Top View

Internal connection diagram

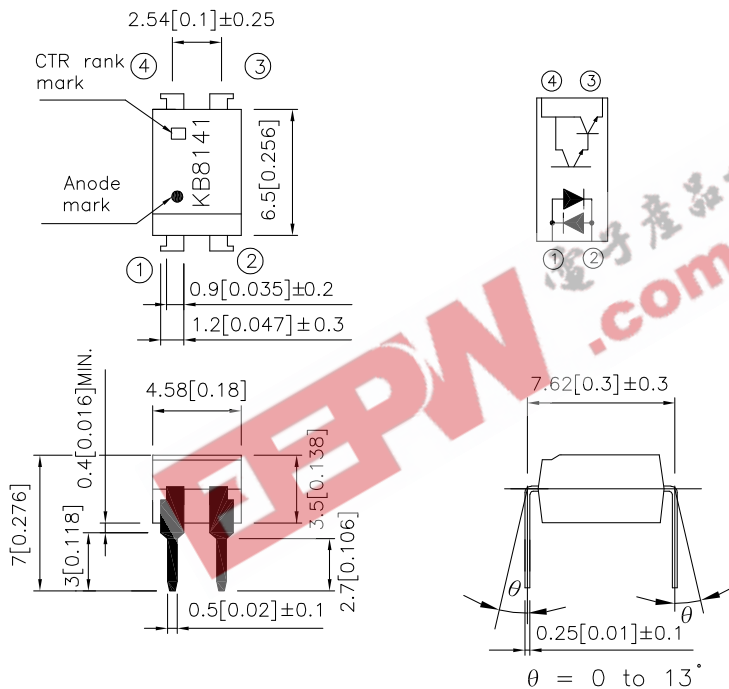

- ① Anode,Cathode ③ Emitter
 ② Anode,Cathode ④ Collector

TOLERANCE : $\pm 0.5[\pm 0.02]$ UNLESS OTHERWISE NOTED.

* Absolute Maximum Ratings (Ta=25°C)

Parameter		Symbol	Rating	Unit
Input	Forward current	I_F	±50	mA
	Power dissipation	P	70	mW
Output	Collector-emitter voltage	V_{CEO}	35	V
	Emitter-collector voltage	V_{ECO}	6	V
	Collector current	I_C	80	mA
	Collector power dissipation	P_C	150	mW
Total power dissipation		P_{tot}	200	mW
*1 Isolation voltage		Viso	5000	V_{rms}
Operating temperature		Topr	-30~+100	°C
Storage temperature		Tstg	-55~+125	°C
*2 Soldering temperature		Tsol	260	°C

*1 40 to 60%RH, AC for 1 minute

*2 For 10 seconds

* Electro-optical Characteristics (Ta=25°C)

Parameter		Symbol	Conditions	Min.	Typ.	Max.	Unit
Input	Forward voltage	V_F	$I_F=\pm 20mA$	—	1.2	1.4	V
	Peak forward voltage	V_{FM}	$I_{FM}=\pm 0.5A$	—	—	3.0	V
Output	Collector dark current	I_{CEO}	$V_{CE}=10V, I_F=0mA$	—	—	10^{-6}	A
Transfer characteristics	*1 Current transfer ratio	CTR	$I_F=\pm 1mA, V_{CE}=2V$	600	—	7500	%
	Collector-emitter saturation voltage	$V_{CE(sat)}$	$I_F=\pm 20mA, I_C=5mA$	—	0.8	1	V
	Cut-off frequency	f_c	$V_{CE}=5V, I_C=2mA$ $R_L=100\Omega, -3dB$	—	6	—	kHz
	Response time	Rise time	t_r	$V_{CE}=2V, I_C=10mA$ $R_L=100\Omega$	—	60	300
Fall time		t_f		—	53	250	μS

$$*1 \text{ CTR} = \frac{I_C}{I_F} \times 100\%$$

Fig. 1 Current Transfer Ratio vs. Forward Current

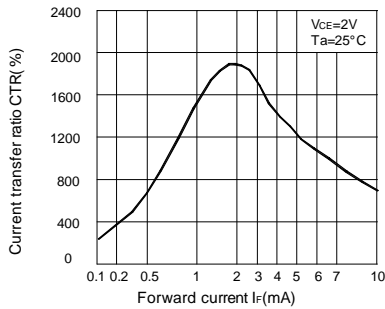

Fig. 2 Forward Current vs. Forward voltage

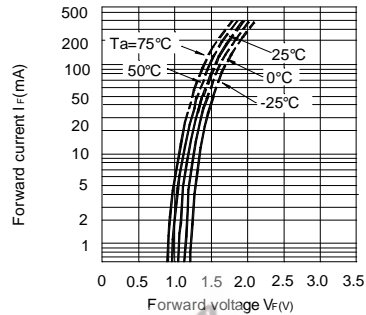

Fig. 3 Collector Current vs. Collector-emitter Voltage

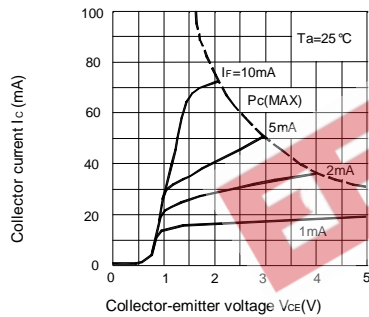

Fig. 4 Relative Current Transfer Ratio vs. Ambient Temperature

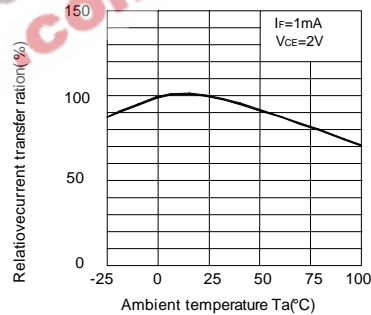

Fig. 5 Collector-emitter Saturation Voltage vs. Ambient Temperature

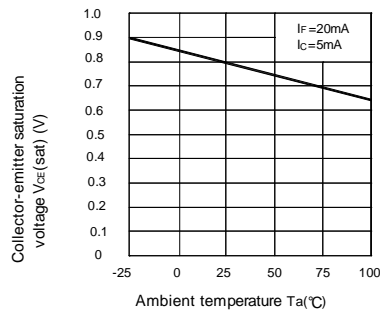

Fig. 6 Collector Dark Current vs. Ambient Temperature

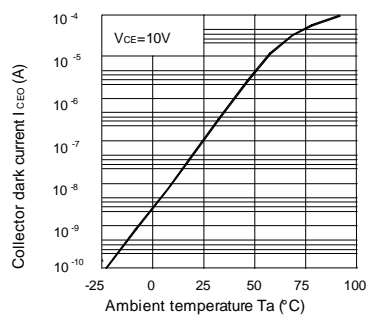

Fig. 7 Forward Current vs. Ambient Temperature

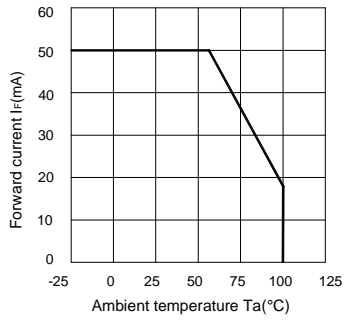

Fig. 8 Collector Power Dissipation vs. Ambient Temperature

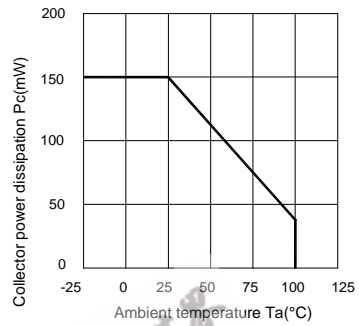
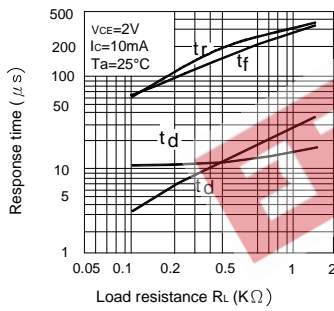

Fig. 9 Response Time vs. Load Resistance



Test Circuit for Response Time

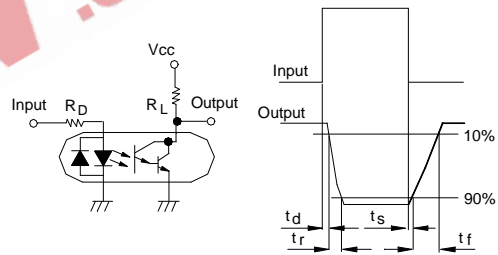
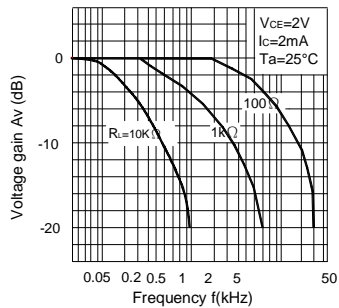

Fig. 10 Frequency Response



Test Circuit for Frequency Response

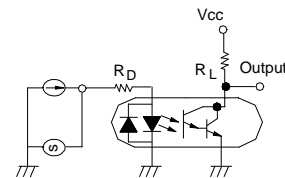
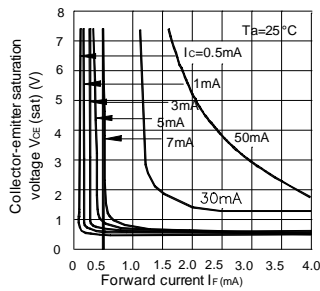

Fig. 11 Collector-emitter Saturation Voltage vs. Forward Current



*** NOTES ON HANDLING**

1. Recommended soldering conditions (Dip soldering)

(1) Dip soldering

Temperature	260° C or below (molten solder temperature)
Time	Less than 10 seconds.
Cycle	One cycle allowed to be dipped in solder including plastic mold portion.
Flux	Rosin flux containing small amount of chlorine (The flux with a maximum chlorine content of 0.2 Wt % is recommended.)

(2) Cautions

Fluxes

Avoid removing the residual flux with freon-based and chlorine-based cleaning solvent.

2. Cautions regarding noise

Be aware that power is suddenly into the component any surge current may cause damage happen, even if the voltage is within the absolute maximum ratings.

CAUTION

Within this device there exists GaAs (Gallium Arsenide) material which is a harmful substance if ingested. GaAs dust and fumes are toxic. Do not break, cut or pulverize the product, or use chemicals to dissolve them.

RESTRICTIONS ON PRODUCT USE

- The information in this document is subject to change without notice. Before using this document, please confirm that this is the latest version. Not all devices / types available in every country.
- We are mention about our product quality stablity, semiconductor devices in general can malfunction or fail due to their inherent electrical sensitivity and vulnerability to physical stress. It is the responsibility of the buyer, when utilizing KINGBRIGHT products, to observe standards of safety, and to a avoid situations in which a malfunction or failure of a KINGBRIGHT product could cause loss of human life, bodily injury or damage to property. In developing your designs, please ensure that KINGBRIGHT products are used within specified operating ranges as set forth in the most recent products specifications.

KB8141

Dimension of Tube

TOLERANCE : $\pm 0.4[\pm 0.012]$ UNLESS OTHERWISE NOTED.
Unit:mm

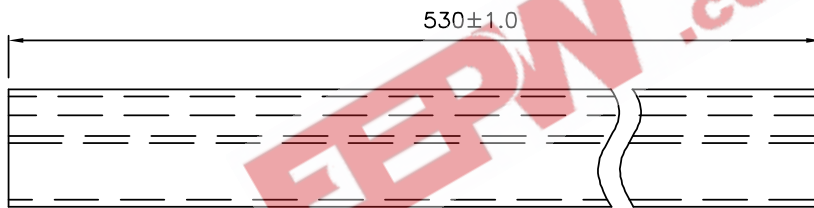
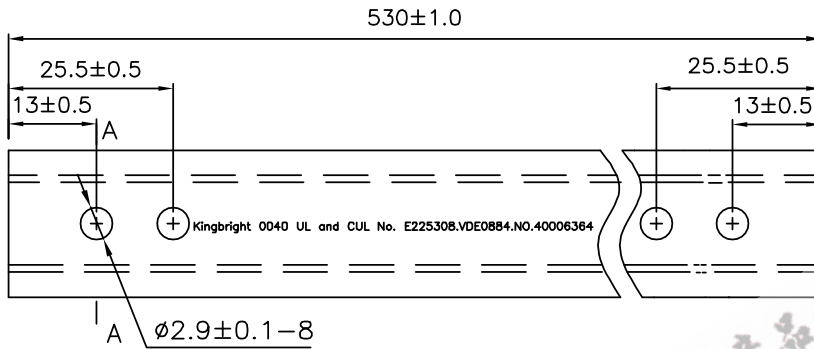

A-A Side view

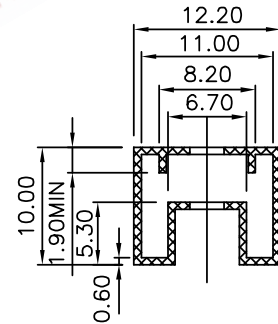

Dimension of Carton

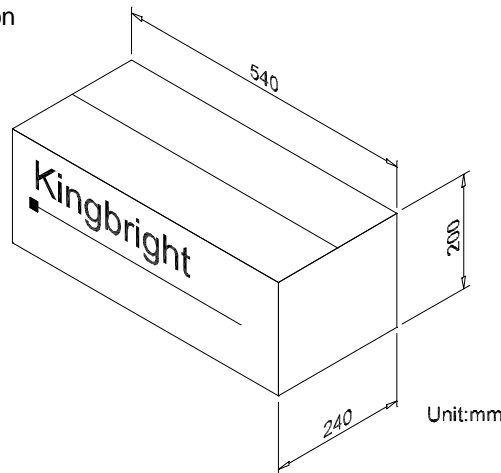

Unit:mm

Part Number	Package	Package Style
KB8141	4-pin DIP	100pcs/each tube