

ROTARY SWITCHES



SPECIFICATIONS

Ratings: 350 mA @ 125 VAC
 150 mA @ 250 VAC
 Electrical Life: 10,000 cycles typical
 Contact Resistance: 25mΩ initial @ 2-4 VDC, 100mA
 Dielectric Strength: 1,500 max V rms at sea level
 Insulation Resistance: 100MΩ min.
 Operating Force: 8.6 N/cm

MATERIALS

Housing, Base, Shaft: Glass filled nylon
 Contact: Silver plated copper alloy
 Gold flash over silver plate
 Hardware: Nut-Zinc, nickel plated
 Lockwasher-Steel, zinc plated
 Stop ring-Brass, nickel plated

HOW TO ORDER

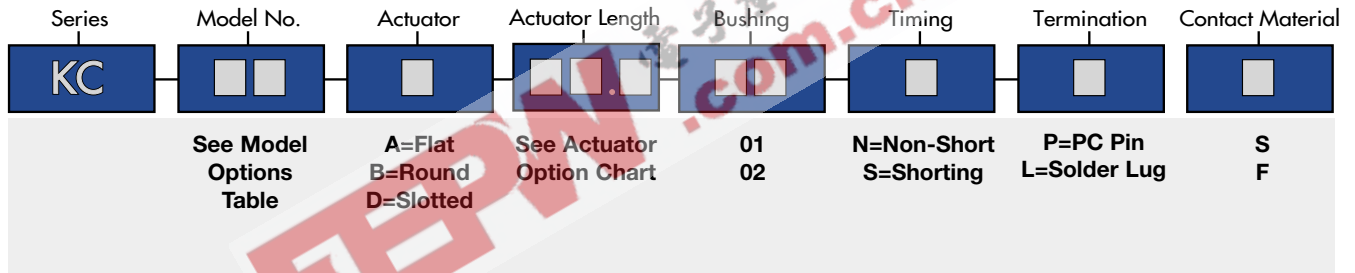

EXAMPLE

KC → 13 → B → 7.0 → 02 → N → L → S

GENERAL INFORMATION

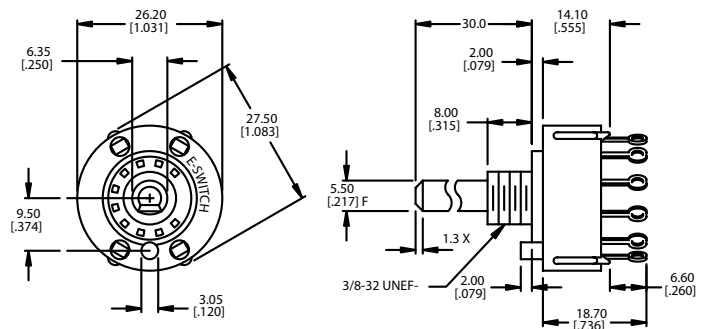

MODEL NUMBER OPTIONS

(SP Models)

Model	Sw. Func.	Terms
10	12-pos.-No stops	A, 1-12
11	ST	A, 2*
12	DT	A, 1,2*
13	3 pos.	A, 1-3*
14	4 pos.	A, 1-4*
15	5 pos.	A, 1-5*
16	6 pos.	A, 1-6*
17	7 pos.	A, 1-7
18	8 pos.	A, 1-8
19	9 pos.	A, 1-9
50	10 pos.	A, 1-10
51	11 pos.	A, 1-11
52	12 pos.	A, 1-12
53	2 pos. -60° index	A, 1,3*
54	2 pos. -90° index	A, 1,4*
55	3 pos. -60° index	A, 1,3,5*
56	3 pos. -90° index	A, 1,4,7
57	4 pos. -60° index	A,1,3,5,7
58	4 pos. -90° index	A,1,4,7,10
59	5 pos. -60° index	A,1,3,5,7,9
60	6 pos. -60° index	A,1,3,5,7,9,11

(DP Models)

Model	Sw. Func.	Terms
20	6-pos.-No stops	A,C,1-12
21	ST	A, C,2,8
22	DT	A,C,1,2,7,8
23	3 pos.	A,C 1-3, 7-9
24	4 pos.	A,C,1-4,7-10
25	5 pos.	A,C,1-5, 7-11
26	6 pos.	A,C,1-12
70	2 pos. 60° index	A,C,1,3,7,9
71	2 pos. 90° index	A,C,1,4,7,10
72	2 pos. 60° index	A,C,1,3,5,7,9,11

(3P Models)

Model	Sw. Func.	Terms
30	4-pos.-No stops	A,B,C,1-12
31	ST	A,B,C,2,6,10
32	DT	A,B,C,1,2,5,6,9,10
33	3 pos.	A,B,C,1-3,5,7,9-11
34	4 pos.	A,B,C,1-12
80	2 pos. 60° index	A,B,C,1,3,5,7,9,11
81	2 pos. -90° index	A,B,C,1,4,5,8,9,12

(4P Models)

Model	Sw. Func.	Terms
40	3-pos.-No stops	all terms
41	ST	A,B,C,D,2,5,8,11
42	DT	A,B,C,D,1,2,4,5,7,10
43	3 pos.	all terms
91	2 pos. 60° index	A,B,C,D,1,3,4,6,7,10

* Note: Switches with P terminations (PC pins) have additional terminal no. 9 as switch support only. This terminal is not connected electrically inside switch.

All models 30° indexing unless otherwise noted.

ACTUATOR OPTIONS

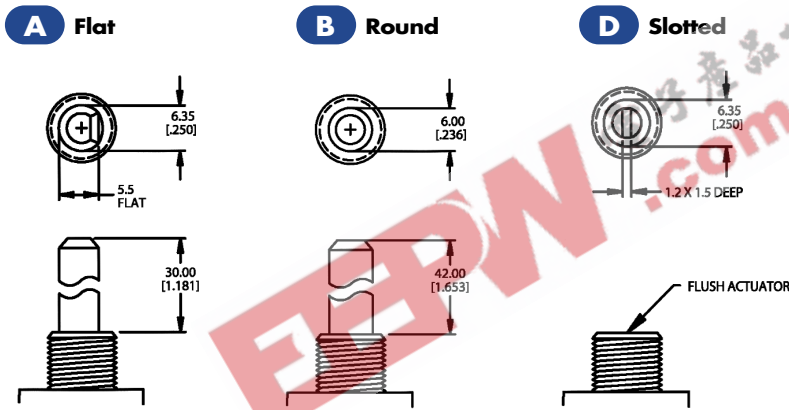

Actuator	Available Actuator Lengths (mm)					
	30.0	38.0	9.5	7.0	10.0	13.0
A	30.0	38.0	9.5	7.0	10.0	13.0
B	30.0	10.0	7.0			
D	0.0	31.5				

*All actuators shown in Pos. 1, fully CCW.

BUSHING OPTIONS

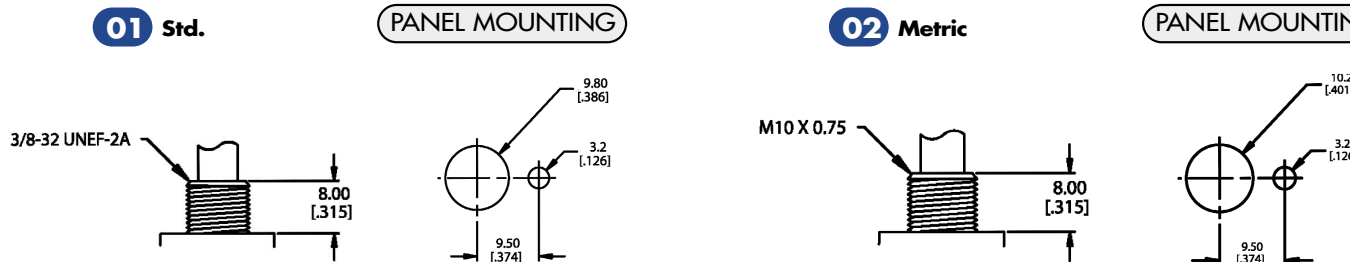

SPECIFICATIONS SUBJECT TO CHANGE WITHOUT NOTICE.

SERIES K C SWITCHES

ROTARY SWITCHES

SCHEMATICS & P.C. MOUNTING

SP Model

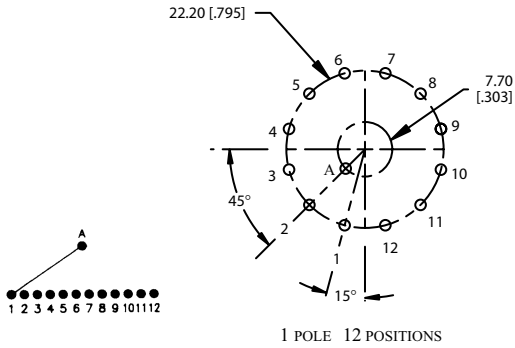

3P Model

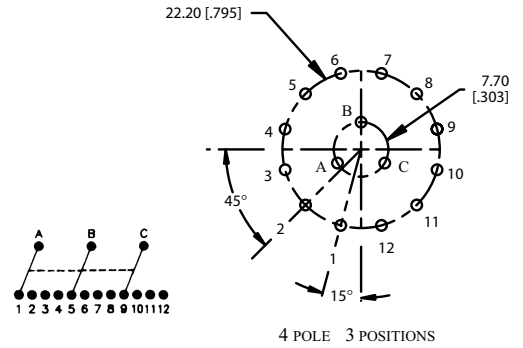

DP Model

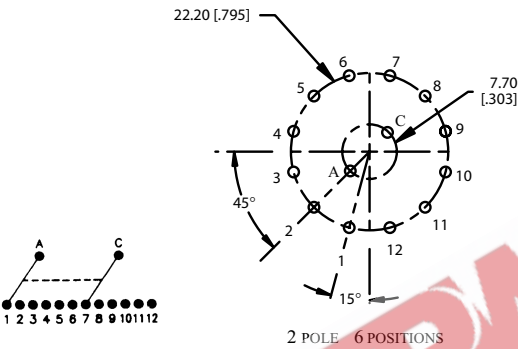

4P Model

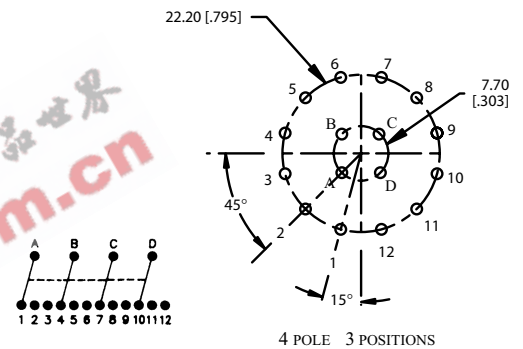

TIMING OPTIONS

N = (STD.) Non-shorting – break before make
S = Shorting – make before break

Note: (S) shorting contacts available only with 30° indexing

TERMINATION OPTIONS

P P.C. Pin

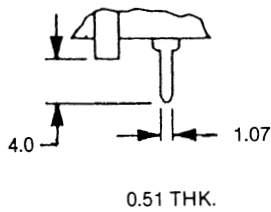

L Solder Lug

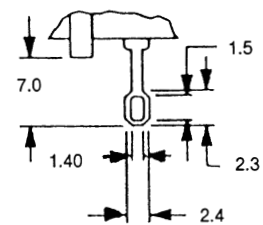

CONTACT MATERIAL OPTIONS

S = Standard Silver over copper alloy

F = Gold Flash over silver plate over copper alloy