

Part Number: KB356NT

Features

- 1.High collector-emitter Voltage.
- 2.Opaque type,mini-flat package.
- 3.Subminiature type (The volume is smaller than that of our conventional DIP type by as far as 30%).
- 4.Isolation voltage between input and output Viso:3750Vrms.
- 5.Emloys double transfer mold technology.
- 6.Recognized by UL and CUL, file NO.E225308.
- 7.Approved by VDE 0884 Teil2(NO:40017614).
- 8.Package : 1000Pcs / Reel.
- 9.RoHS Compliant.

Applications

- 1.Hybrid substrates that require high density mounting.
- 2.Programmable controllers.

*PACKAGE DIMENSIONS (UNIT:mm)

SMD Type

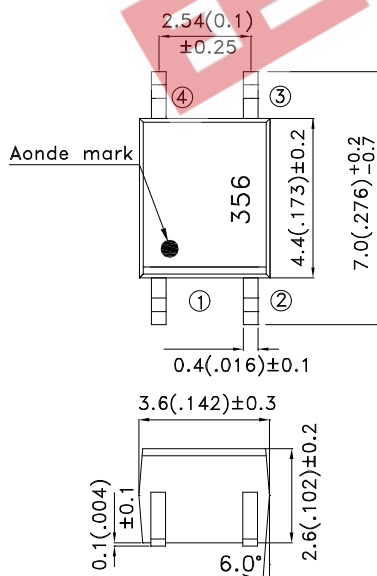

Internal connection diagram

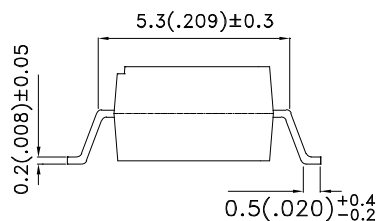
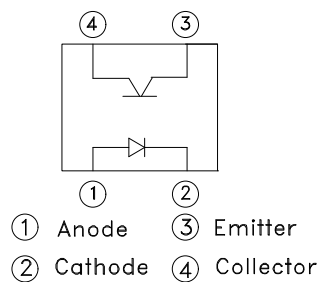

UNIT : MM[INCH]
TOLERANCE : ±0.5[±0.02] UNLESS OTHERWISE NOTED.



*Absolute Maximum Ratings (Ta=25°C)

Parameter		Symbol	Rating	Unit
Input	Forward current	I _F	50	mA
	Reverse Voltage	V _R	6	V
	Power dissipation	P _d	70	mW
Output	Collector-emitter voltage	V _{CEO}	80	V
	Emitter-collector voltage	V _{ECO}	6	V
	Collector current	I _c	50	mA
	Collector power dissipation	P _c	150	mW
Total power dissipation		P _{tot}	170	mW
*1 Isolation voltage		V _{iso}	3750	V _{rms}
Operating temperature		T _{opr}	-30 to +100	°C
Storage temperature		T _{stg}	-40 to +125	°C
*2 Soldering temperature		T _{sol}	260	°C

*1 40 to 60%RH, AC for 1 minute.

*2 For 10 seconds.

*Electro-optical Characteristics

Parameter		Symbol	Conditions	Min.	Typ.	Max.	Unit	
Input	Forward voltage	V _F	I _F =20mA	-	1.2	1.4	V	
	Peak forward voltage	V _{FM}	I _{FM} =0.5A	-	-	3.0	V	
	Reverse current	I _R	V _R =4V	-	-	10	uA	
Output	Collector dark current	I _{CEO}	V _{ce} = 20V I _F = 0	-	-	10 ⁻⁷	A	
	Collector-emitter breakdown voltage	BV _{CEO}	I _c =0.1mA I _F =0	80	-	-	V	
	Emitter-collector breakdown voltage	BV _{ECO}	I _E =10uA I _F =0	6	-	-	V	
Transfer characteristics	Current transfer ration		CTR	I _F =5mA V _{ce} =5V	50	-	600	%
	Collector-emitter saturation voltage		V _{CE (sat)}	I _F =20mA I _C =1mA	-	0.1	0.2	V
	Response time	Rise time	T _r	V _{ce} = 2V I _C =2mA RL=100Ω	-	6	-	uS
		Fall time	T _r		-	8	-	uS

Part Number: KB356NT

Model No.	Rank mark	CTR(%)
KB356NLT	L	50 to 100
KB356N1T	A	80 to 160
KB356N2T	B	130 to 260
KB356N3T	C	200 to 400
KB356N4T	D	300 to 600
KB356N5T	A or B	80 to 260
KB356N6T	B or C	130 to 400
KB356N7T	C or D	200 to 600
KB356N8T	A,B or C	80 to 400
KB356N9T	B,C or D	130 to 600
KB356N0T	A,B,C or D	80 to 600
KB356NT	L,A,B,C,D or No mark	50 to 600

EEPW.com.cn 电子产品世界

Fig. 1 Current Transfer vs. Forward Current

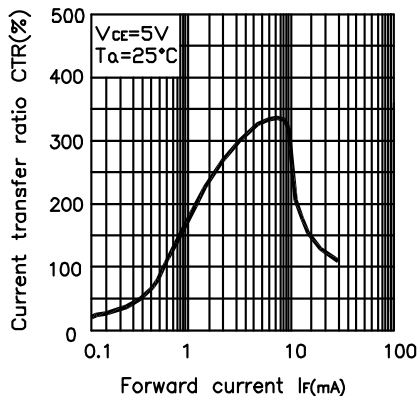

Fig. 2 Forward Current vs. Forward voltage

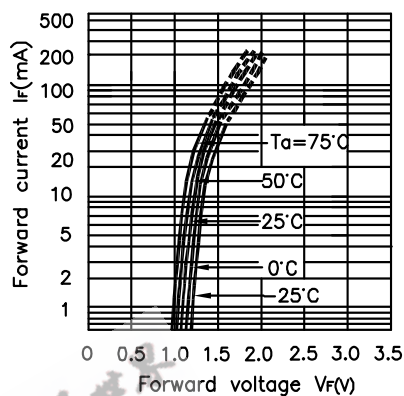

Fig. 3 Collector Current vs. Collector-emitter Voltage

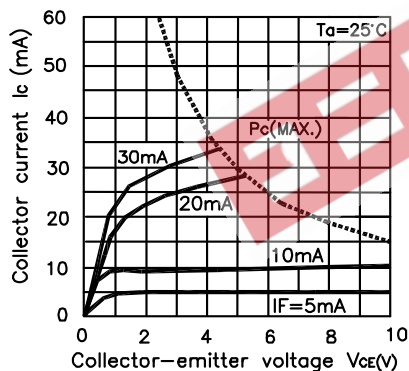

Fig. 4 Relative Current Transfer Ratio vs. Ambient Temperature

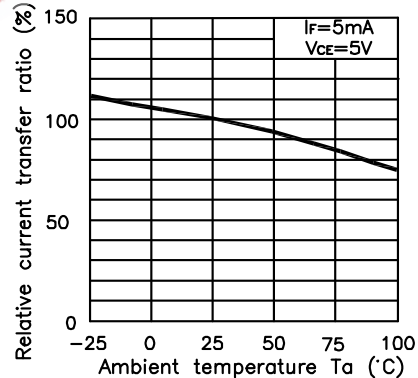

Fig. 5 Collector-emitter Saturation Voltage vs. Ambient Temperature

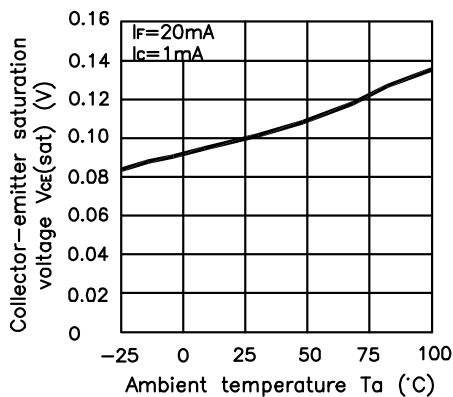

Fig. 6 Response Time vs. Load Resistance

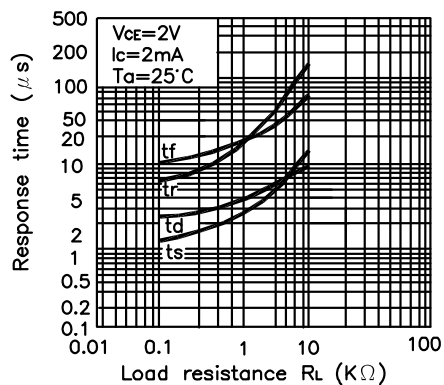

Fig. 7 Collector-emitter Saturation Voltage vs. Forward Current

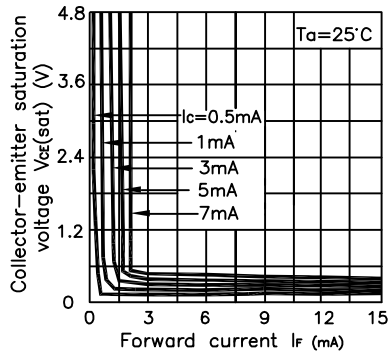
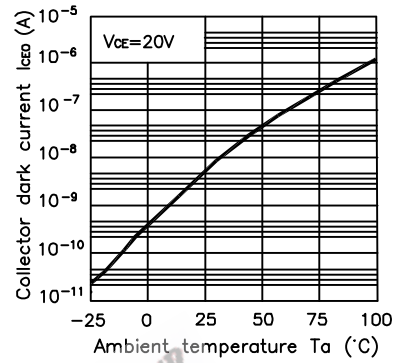
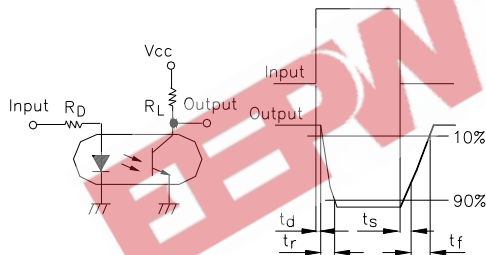

Fig. 8 Collector Dark Current vs. Ambient Temperature



Test Circuit for Response Time



* NOTES ON HANDLING

1.Recommended soldering conditions (Dip soldering)

(1) Dip soldering

Temperature	260 or below (molten solder temperature)
Time	Less than 10 seconds.
Cycle	One cycle allowed to be dipped in solder including plastic mold portion.
Flux	Rosin flux containing small amount of chlorine (The flux with a maximum chlorine content of 0.2 Wt % is recommended.)

(2) Cautions

Fluxes

Avoid removing the residual flux with freon-based and chlorine-based cleaning solvent.

2.Cautions regarding noise

Be aware that power is suddenly into the component any surge current may cause damage happen, even if the voltage is within the absolute maximum ratings.

Reflow Soldering Profile For Lead-free SMT Process.

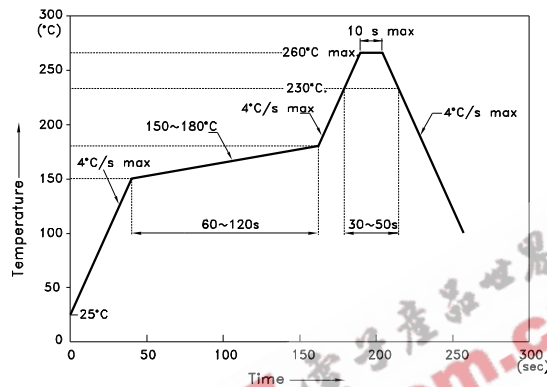

NOTES:

1. We recommend the reflow temperature 245°C(+/-5°C). The maximum soldering temperature should be limited to 260°C.
2. Don't cause stress to the epoxy resin while it is exposed to high temperature.
3. Number of reflow process shall be 2 times or less.

CAUTION

Within this device there exists GaAs (Gallium Arsenide) material which is a harmful substance if ingested.

GaAs dust and fumes are toxic. Do not break, cut or pulverize the product, or use chemicals to dissolve them.

RESTRICTIONS ON PRODUCT USE

- The information in this document is subject to change without notice. Before using this document, please confirm that this is the latest version. Not all devices / types available in every country.
- We are mention about our product quality stability, semiconductor devices in general can malfunction or fail due to their inherent electrical sensitivity and vulnerability to physical stress. It is the responsibility of the buyer, when utilizing KINGBRIGHT products, to observe standards of safety, and to a avoid situations in which a malfunction or failure of a KINGBRIGHT product could cause loss of human life, bodily injury or damage to property. In developing your designs, please ensure that KINGBRIGHT products are used within specified operating ranges as set forth in the most recent products specifications.

Part Number: KB356NT

Outline and Dimension(Tape)
(Units : mm)

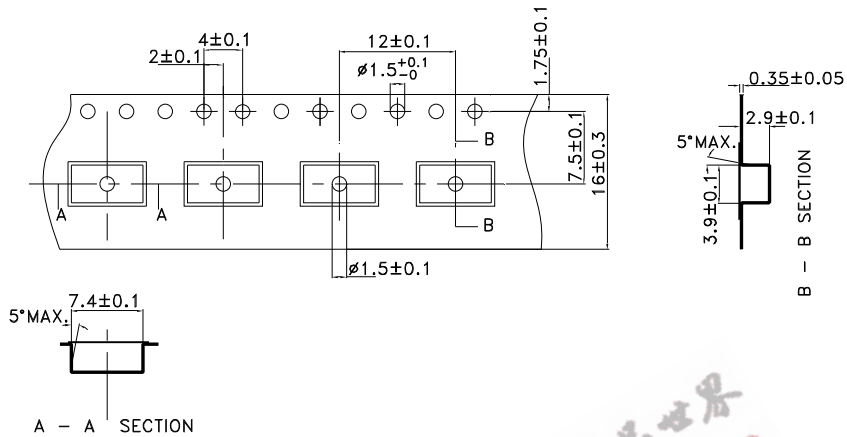

Tape Direction

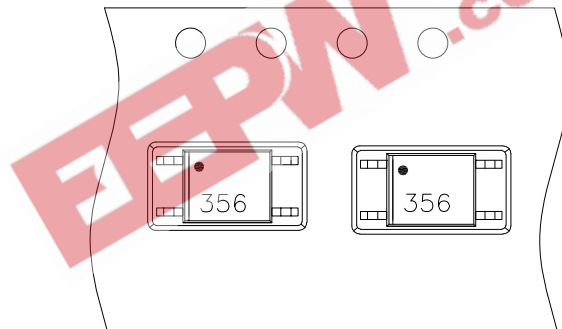

Outline and Dimension(Reel)

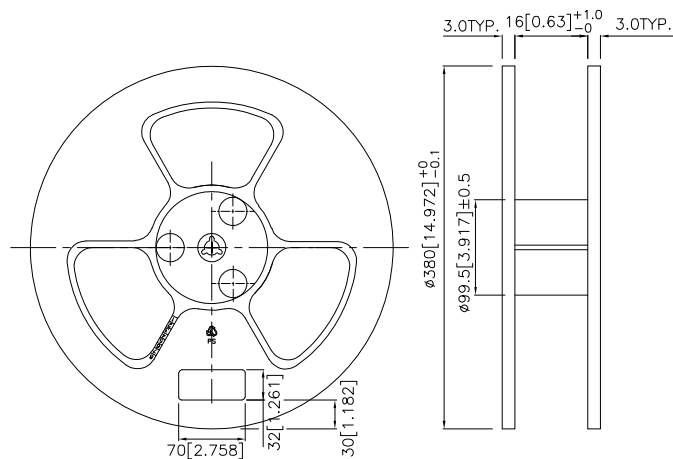

Packing: 1000pcs/reel

Part Number: KB356NT

PACKING & LABEL SPECIFICATIONS

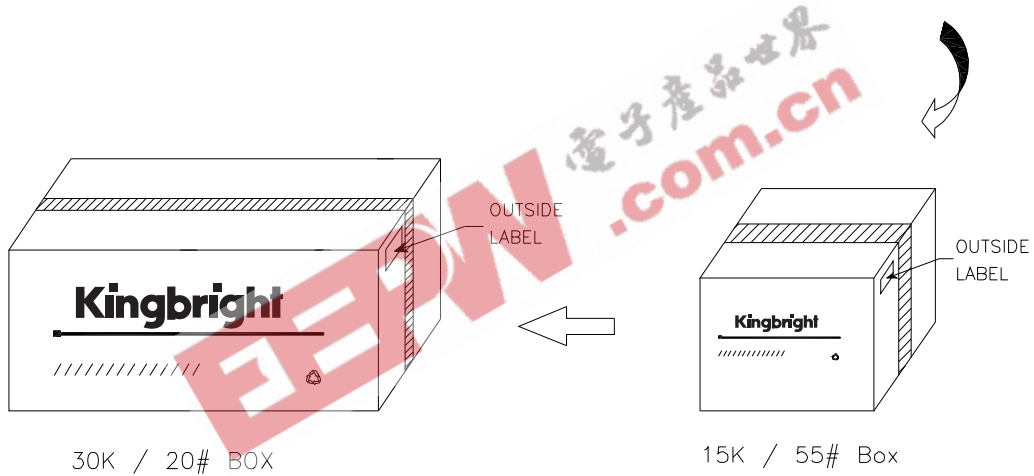
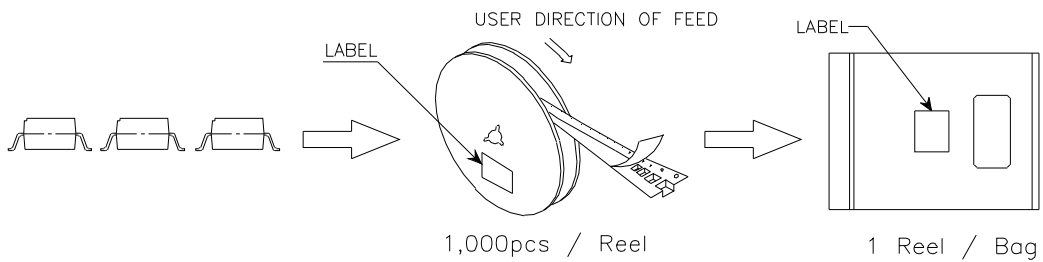

<h1>Kingbright</h1>				
P/N : KB356XXX				
QTY: 1,000 pcs	Q.C. <table border="1"><tr><td>Q C</td></tr><tr><td>xx xx xx</td></tr><tr><td>PASSED</td></tr></table>	Q C	xx xx xx	PASSED
Q C				
xx xx xx				
PASSED				
S/N: XXXX				
CODE: XXX				
LOT NO:				
 XXXXXXXXXXXXXXXXXXXXXXXXXXXX				
RoHS Compliant				