

KA78RXXC-Series

1A Output Low Dropout Voltage Regulators

Features

- 1A/3.3V, 5V, 8V, 9V, 12V, 15V output low dropout voltage regulator
- TO-220 full-mold package (4pin)
- Overcurrent protection, thermal shutdown
- Overvoltage protection, short circuit protection
- With output disable function

Description

The KA78RXXC is a low-dropout voltage regulator suitable for various electronic equipments.

It provides constant voltage power source with TO-220-4 lead full mold package. Dropout voltage of KA78RXXC is below 0.5V in full rated current(1A).

This regulator has various functions such as peak current protection, thermal shut down, overvoltage protection and output disable function.

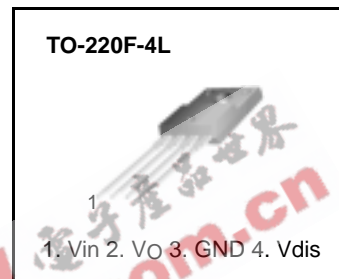

Internal Block Diagram

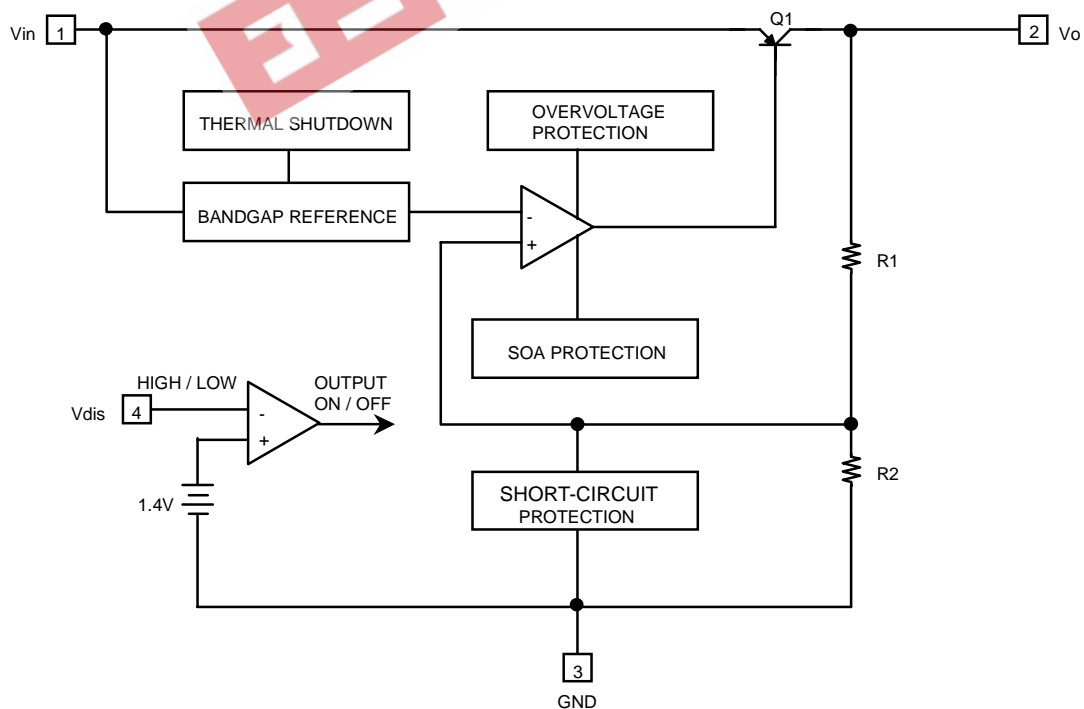

Absolute Maximum Ratings

KA78RXXC

Parameter	Symbol	Value	Unit	Remark
Input voltage	V _{in}	35	V	-
Disable voltage	V _{dis}	35	V	-
Output current	I _o	1.0	A	-
Power dissipation 1	P _{d1}	1.5	W	No heatsink
Power dissipation 2	P _{d2}	15	W	With heatsink
Junction temperature	T _j	+150	°C	-
Operating temperature	T _{opr}	-20 ~ +80	°C	-
Thermal resistance, junction-to case (Note2)	R _{θjc}	4.31	°C/W	-
Thermal resistance, junction-to-air (Note2)	R _{θja}	48.83	°C/W	-

EEPW 电子产品世界
.com.cn

Electrical Characteristics

(V_{in} = Note3, I_o = 0.5A, T_a = 25°C, unless otherwise specified)

Parameter	Symbol	Conditions	Min.	Typ.	Max.	Unit
Output voltage	KA78R33C	-	3.22	3.3	3.38	V
	KA78R05C	-	4.88	5	5.12	
	KA78R08C	-	7.8	8	8.2	
	KA78R09C	-	8.78	9	9.22	
	KA78R12C	-	11.7	12	12.3	
	KA78R15C	-	14.6	15	15.4	
Load regulation	Rload	5mA < I_o < 1A	-	0.1	2.0	%
Line regulation	Rline	Note4	-	0.5	2.5	%
Ripple rejection ratio	RR	Note1	45	55	-	dB
Dropout voltage	Vdrop	I_o = 1A	-	-	0.5	V
Disable voltage high	VdisH	Output active	2.0	-	-	V
Disable voltage low	VdisL	Output disabled	-	-	0.8	V
Disable bias current high	IdisH	Vdis = 2.7V	-	-	20	μA
Disable bias current low	IdisL	Vdis = 0.4V	-	-	-0.4	mA
Quiescent current	Iq	I_o = 0A	-	-	10	mA

Note:

1. These parameters, although guaranteed, are not 100% tested in production.

2. Junction -to -case thermal resistance test environments.

- . Pneumatic heat sink fixture.

- . Clamping pressure 60psi through 12mm diameter cylinder.

- . Thermal grease applied between PKG and heat sink fixture.

3. KA78R33C : V_{in} = 5V

KA78R05C : V_{in} = 7V

KA78R08C : V_{in} = 10V

KA78R09C : V_{in} = 11V

KA78R12C : V_{in} = 15V

KA78R15C : V_{in} = 20V

4. KA78R33C : V_{in} = 4V to 10V

KA78R05C : V_{in} = 6V to 12V

KA78R08C : V_{in} = 9V to 25V

KA78R09C : V_{in} = 10V to 25V

KA78R12C : V_{in} = 13V to 29V

KA78R15C : V_{in} = 16V to 30V

Typical Performance Characteristics

KA78R33

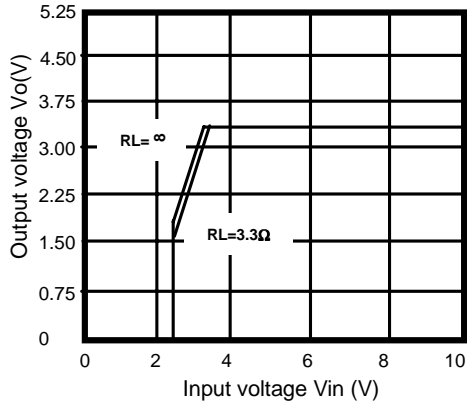

Figure 1. Output Voltage vs. Input Voltage

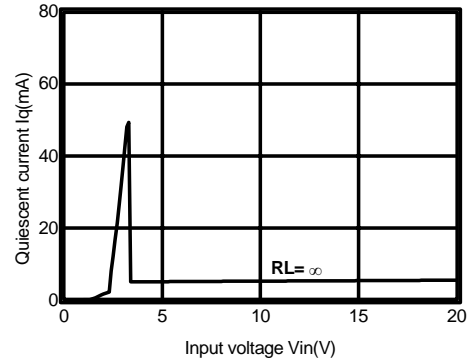

Figure 2. Quiescent Current vs. Input Voltage

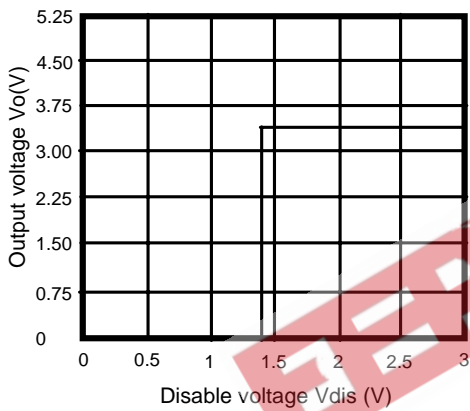

Figure 3. Output Voltage vs. Disable Voltage

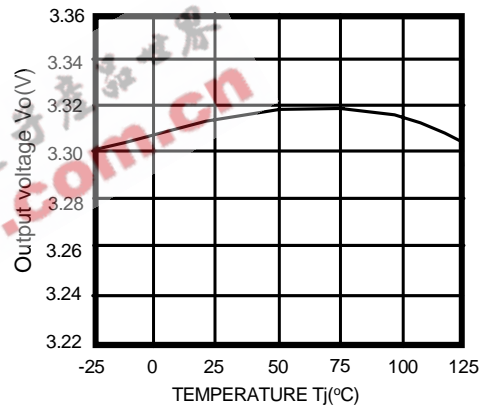

Figure 4. Output Voltage vs. Temperature(Tj)

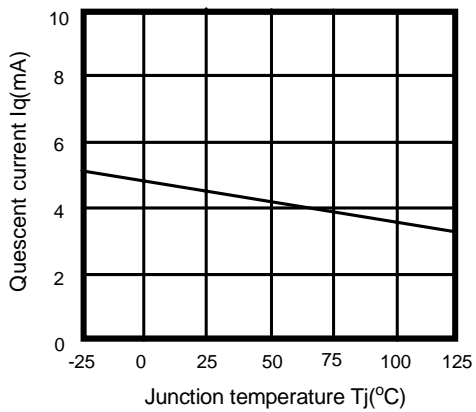

Figure 5. Quiescent Current vs. Temperature(Tj)

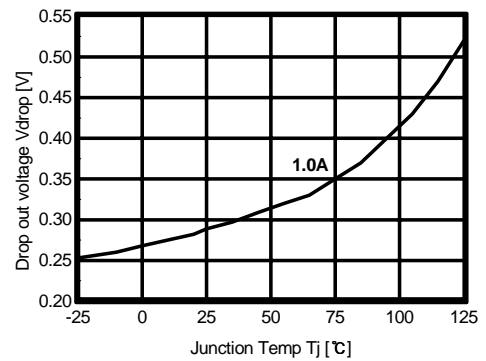

Figure 6. Dropout Voltage vs. Junction Temperature

Typical Performance Characteristics (Continued)

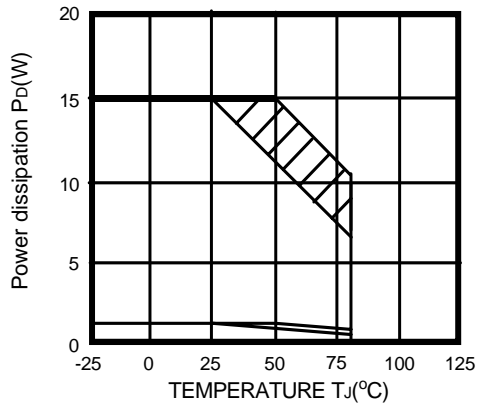

Figure 7. Power Dissipation vs. Temperature(T_j)

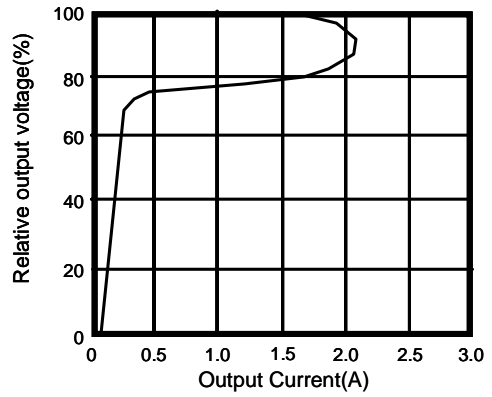

Figure 8. Overcurrent Protection Characteristics (Typical Value)

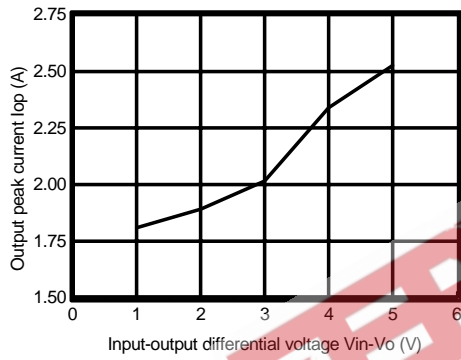

Figure 9. Output Peak Current vs. Input-Output Differential Voltage

EEPW.com.cn 电子产品世界

Typical Performance Characteristics

KA78R05C

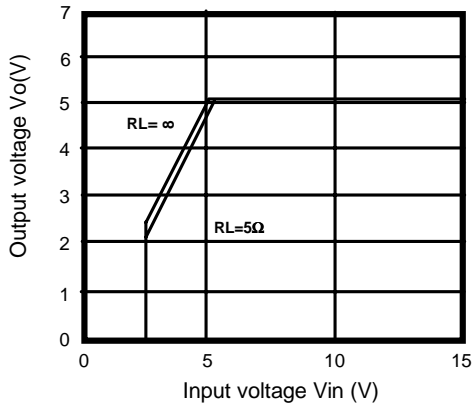

Figure 1. Output Voltage vs. Input Voltage

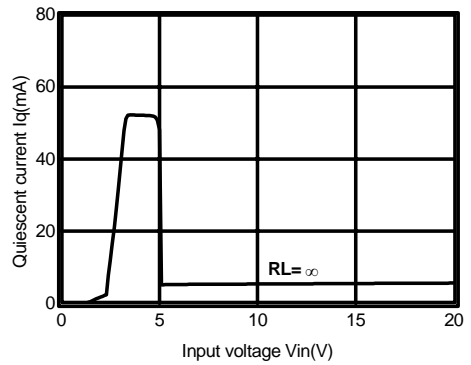

Figure 2. Quiescent Current vs. Input Voltage

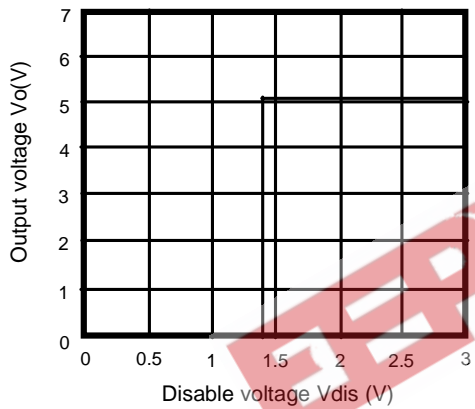

Figure 3. Output Voltage vs. Disable Voltage

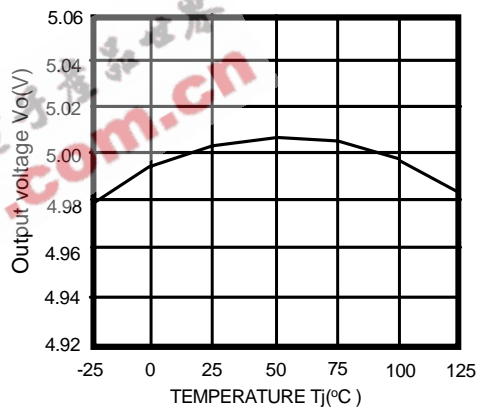

Figure 4. Output Voltage vs. Temperature(Tj)

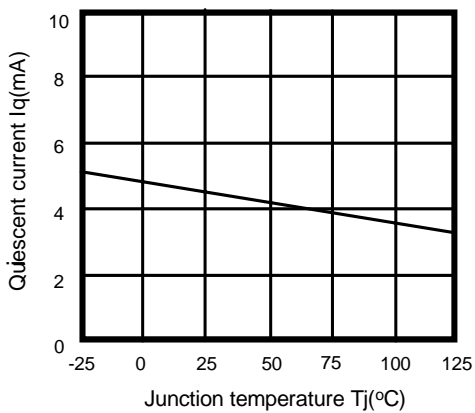

Figure 5. Quiescent Current vs. Temperature(Tj)

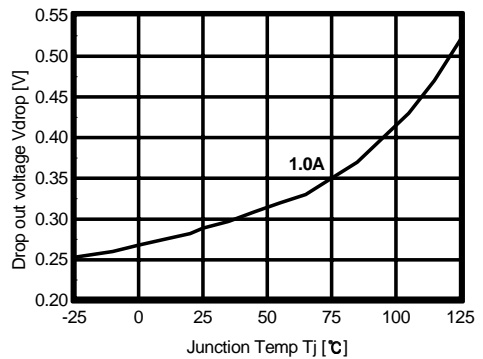

Figure 6. Dropout Voltage vs. Junction Temperature

Typical Performance Characteristics (Continued)

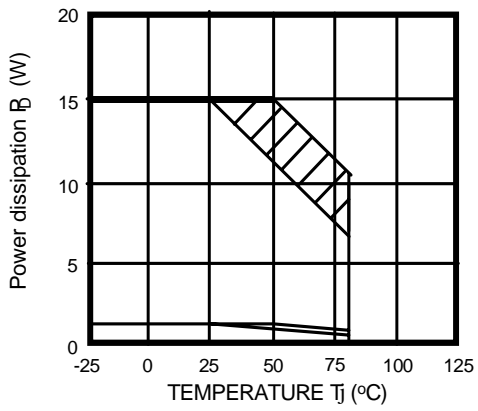

Figure 7. Power Dissipation vs. Temperature(Tj)

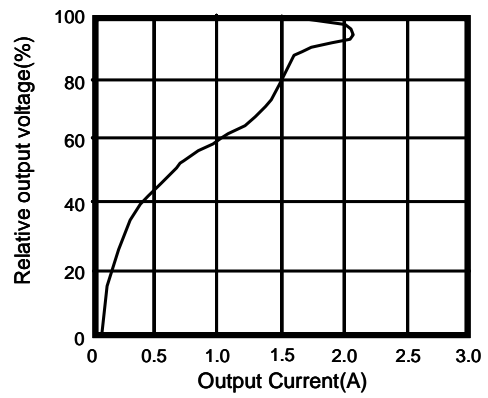

Figure 8. Overcurrent Protection Characteristics (Typical Value)

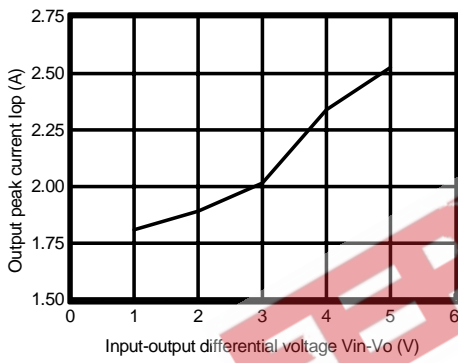

Figure 9. Output Peak Current vs. Input-Output Differential Voltage

Typical Performance Characteristics (Continued)

KA78R08C

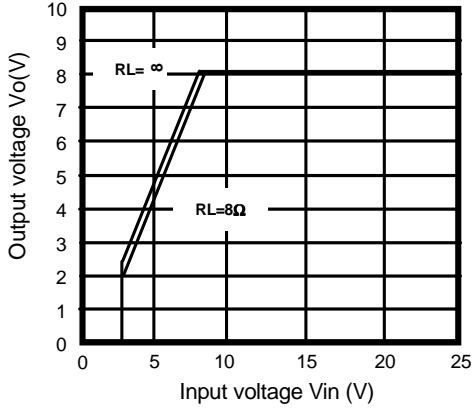

Figure 1. Output Voltage vs. Input Voltage

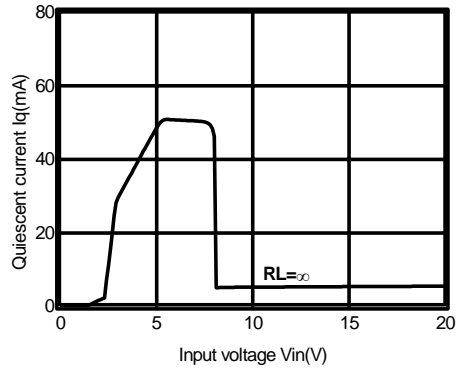

Figure 2. Quiescent Current vs. Input Voltage

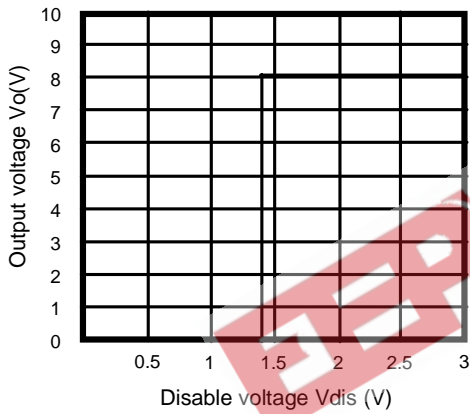

Figure 3. Output Voltage vs. Disable Voltage

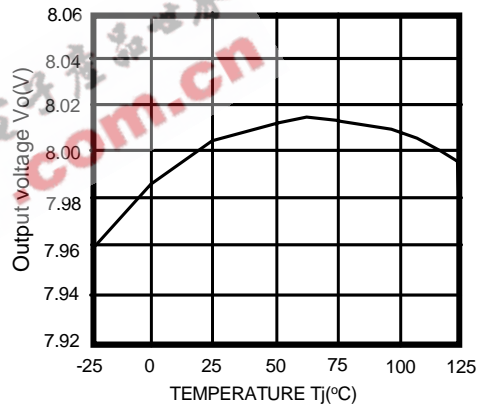

Figure 4. Output Voltage vs. Temperature(Tj)

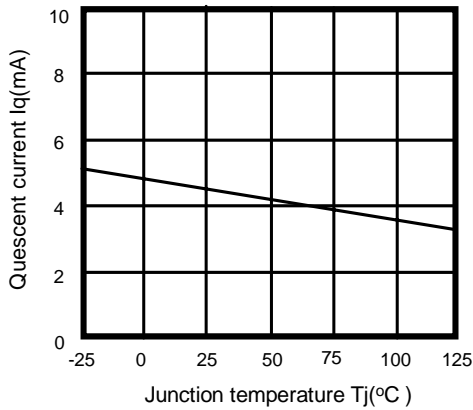

Figure 5. Quiescent Current vs. Temperature(Tj)

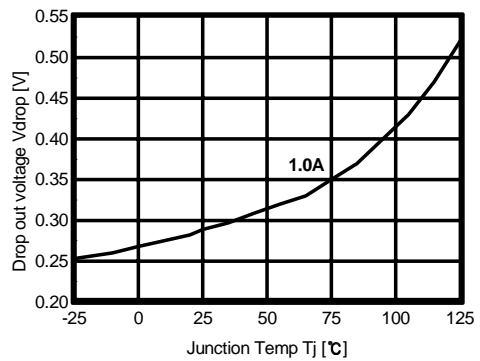

Figure 6. Dropout Voltage vs. Junction Temperature

Typical Performance Characteristics (Continued)

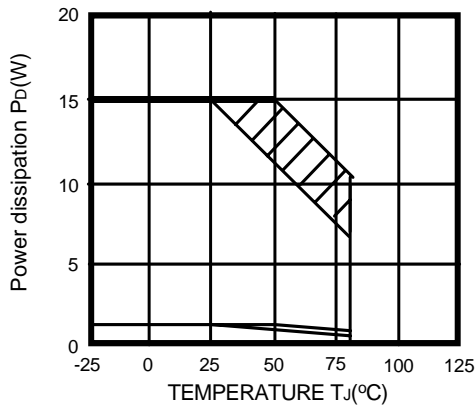

Figure 7. Power Dissipation vs. Temperature(T_j)

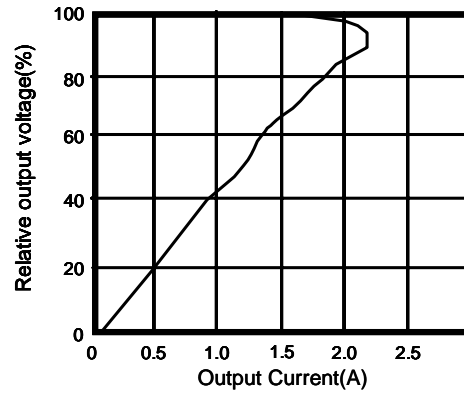

Figure 8. Overcurrent Protection Characteristics (Typical Value)

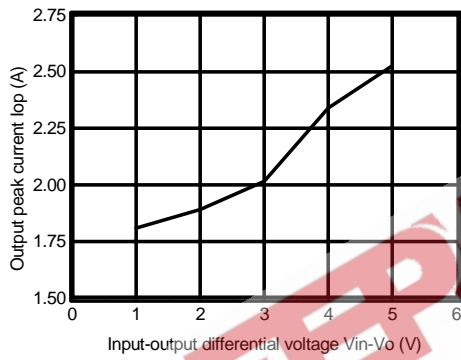

Figure 9. Output Peak Current vs. Input-Output Differential Voltage

EEPW.com.cn 电子产品世界

Typical Performance Characteristics (Continued)

KA78R09C

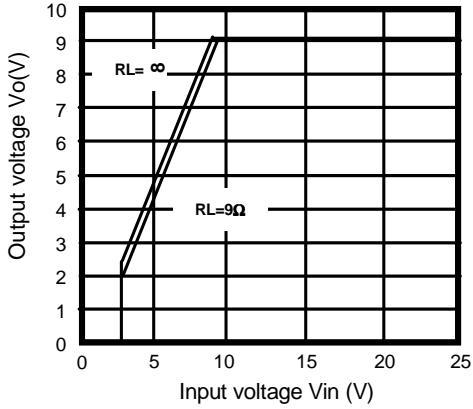

Figure 1. Output Voltage vs. Input Voltage

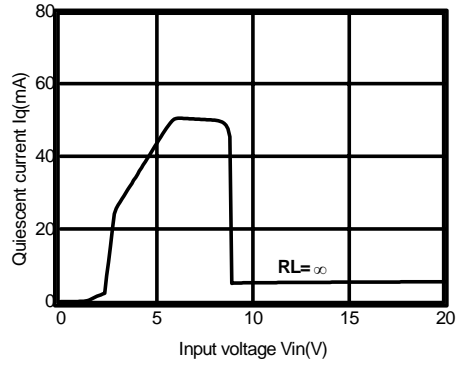

Figure 2. Quiescent Current vs. Input Voltage

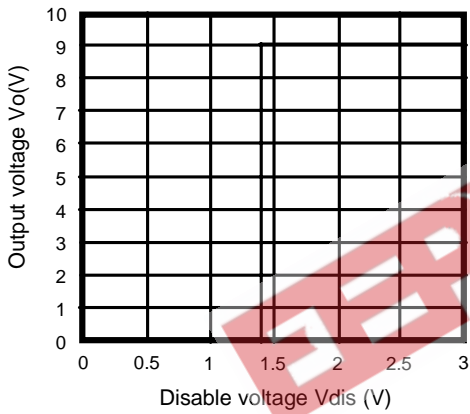

Figure 3. Output Voltage vs. Disable Voltage

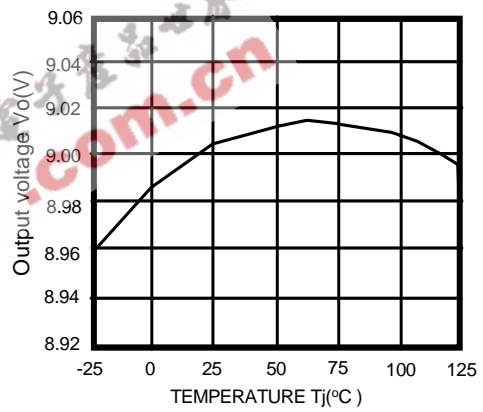

Figure 4. Output Voltage vs. Temperature(T_j)

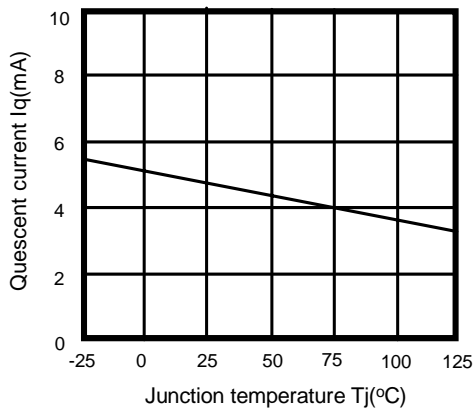

Figure 5. Quiescent Current vs. Temperature(T_j)

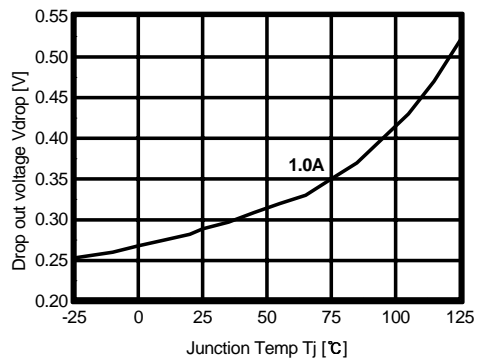

Figure 6. Dropout Voltage vs. Junction Temperature

Typical Performance Characteristics (Continued)

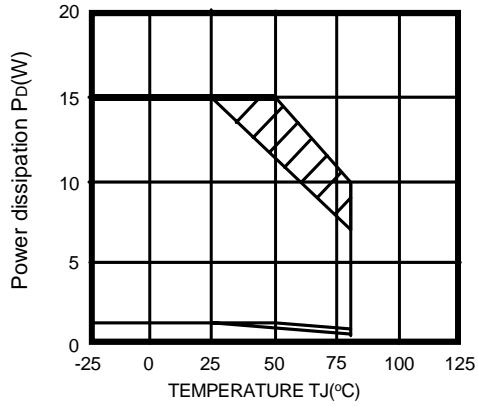

Figure 7. Power Dissipation vs. Temperature(Tj)

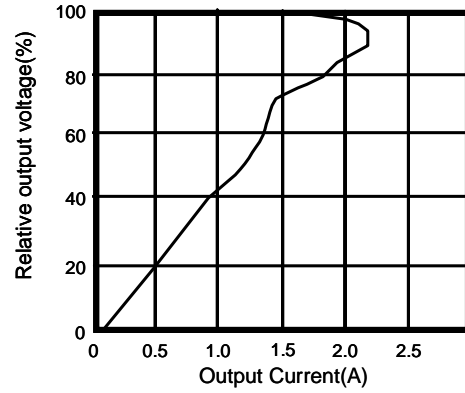

Figure 8. Overcurrent Protection Characteristics (Typical Value)

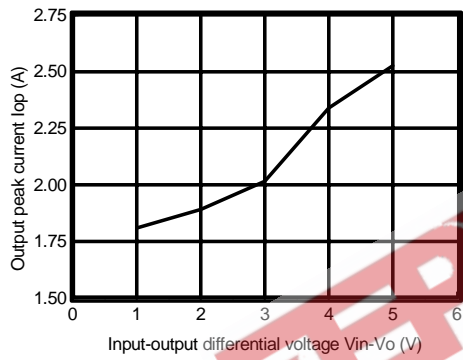

Figure 9. Output Peak Current vs. Input-Output Differential Voltage

EEPW 电子产品世界 .com.cn

Typical Performance Characteristics (Continued)

KA78R12C

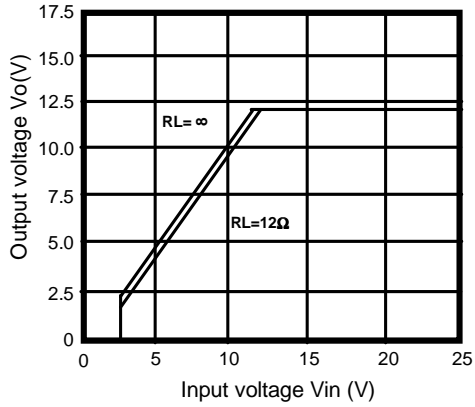

Figure 1. Output Voltage vs. Input Voltage

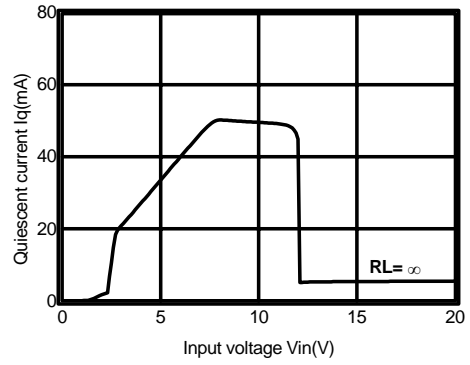

Figure 2. Quiescent Current vs. Input Voltage

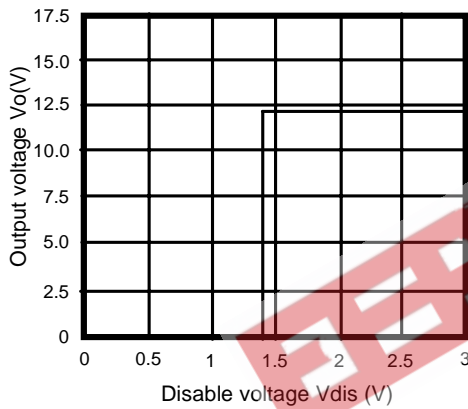

Figure 3. Output Voltage vs. Disable Voltage

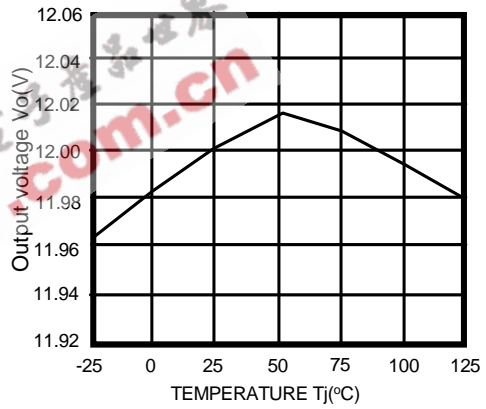

Figure 4. Output Voltage vs. Temperature(Tj)

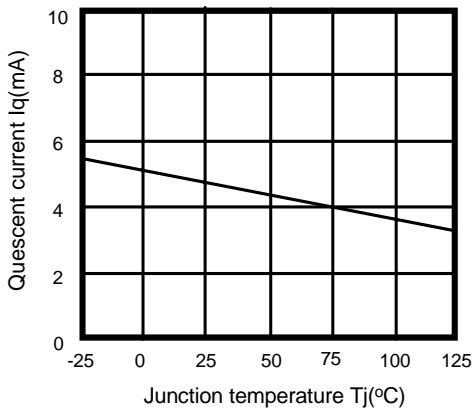

Figure 5. Quiescent Current vs. Temperature(Tj)

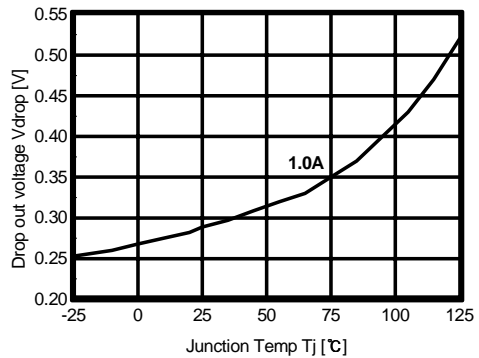

Figure 6. Dropout Voltage vs. Junction Temperature

Typical Performance Characteristics (Continued)

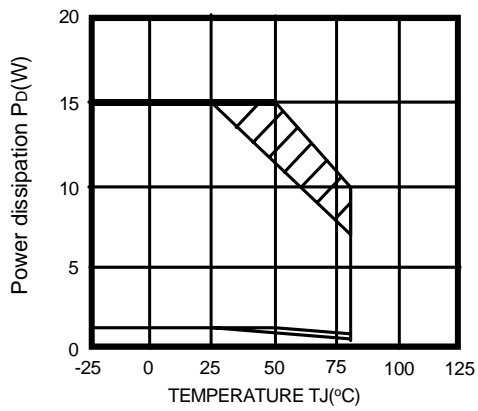

Figure 7. Power Dissipation vs. Temperature(Tj)

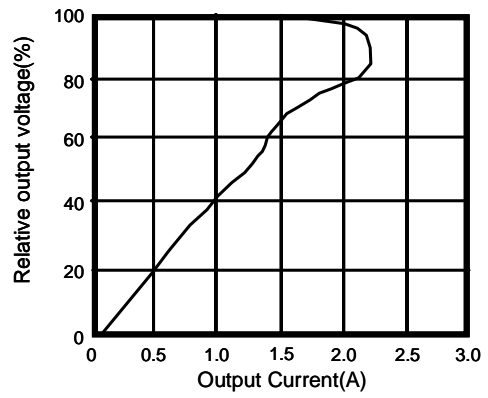

Figure 8. Overcurrent Protection Characteristics (Typical Value)

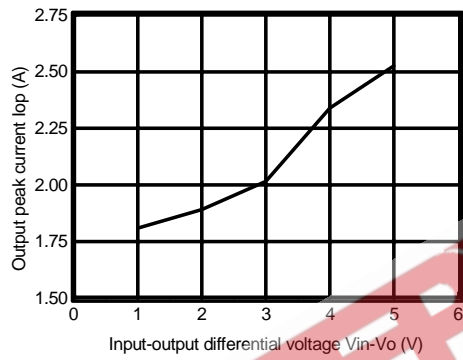

Figure 9. Output Peak Current vs. Input-Output Differential Voltage

Typical Performance Characteristics (Continued)

KA78R15C

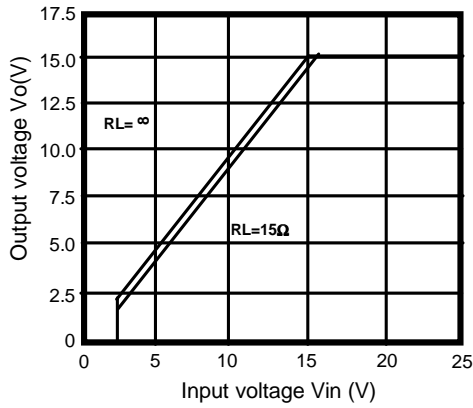

Figure 1. Output Voltage vs. Input Voltage

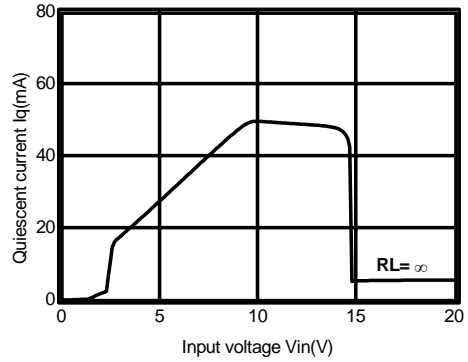

Figure 2. Quiescent Current vs. Input Voltage

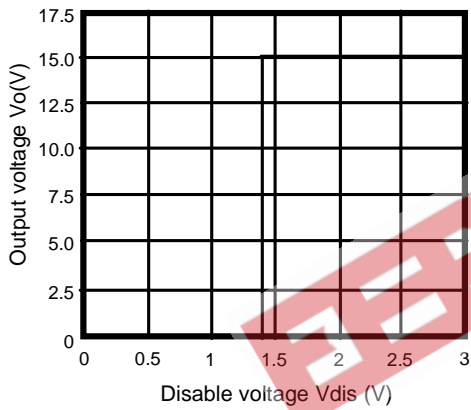

Figure 3. Output Voltage vs. Disable Voltage

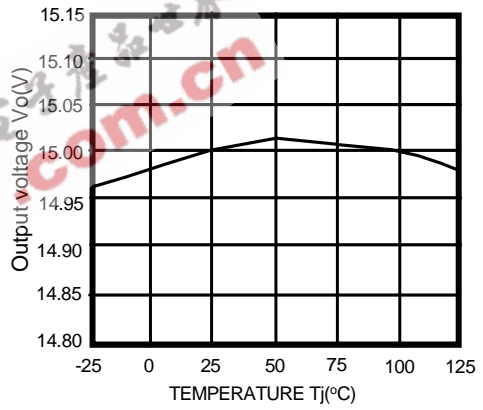

Figure 4. Output Voltage vs. Temperature(T_j)

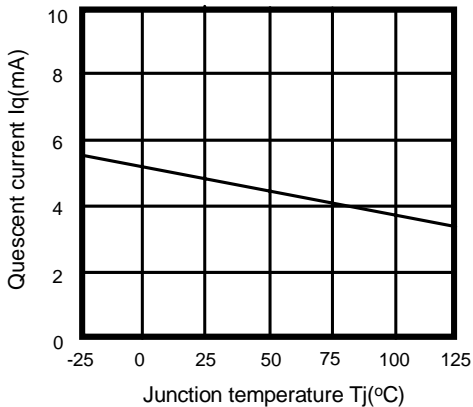

Figure 5. Quiescent Current vs. Temperature(T_j)

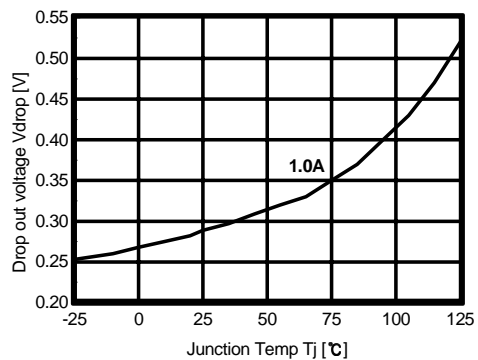

Figure 6. Dropout Voltage vs. Junction Temperature

Typical Performance Characteristics (Continued)

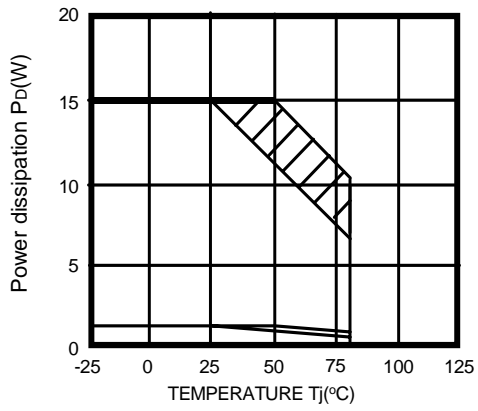

Figure 7. Power Dissipation vs. Temperature(T_j)

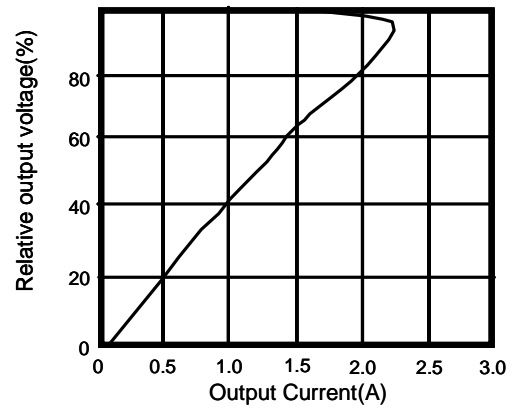

Figure 8. Overcurrent Protection Characteristics (Typical Value)

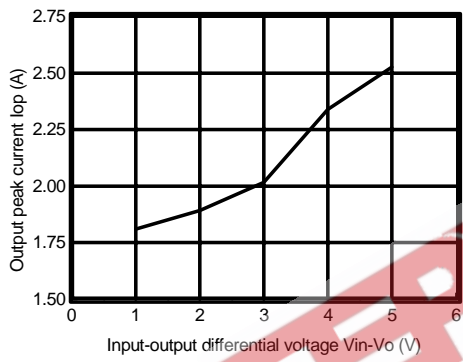

Figure 9. Output Peak Current vs. Input-Output Differential Voltage

Typical Application

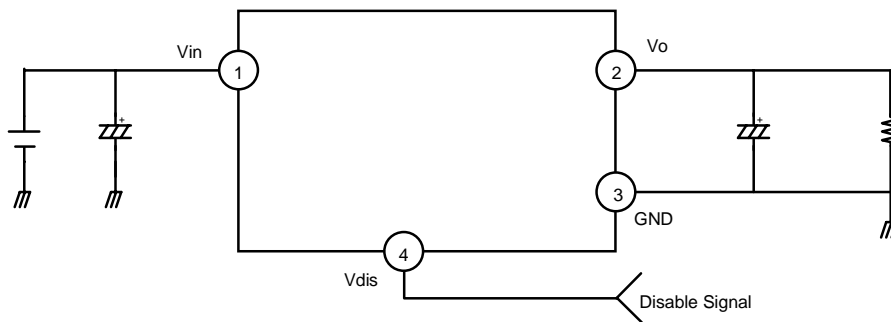

Figure 1. Application Circuit

- C_i is required if regulator is located at an appreciable distance from power supply filter.
- C_o improves stability and transient response. ($C_o > 47\mu\text{F}$)

EEPW 电子产品世界
.com.cn

Mechanical Dimensions

Package

Dimensions in millimeters

TO-220F-4L

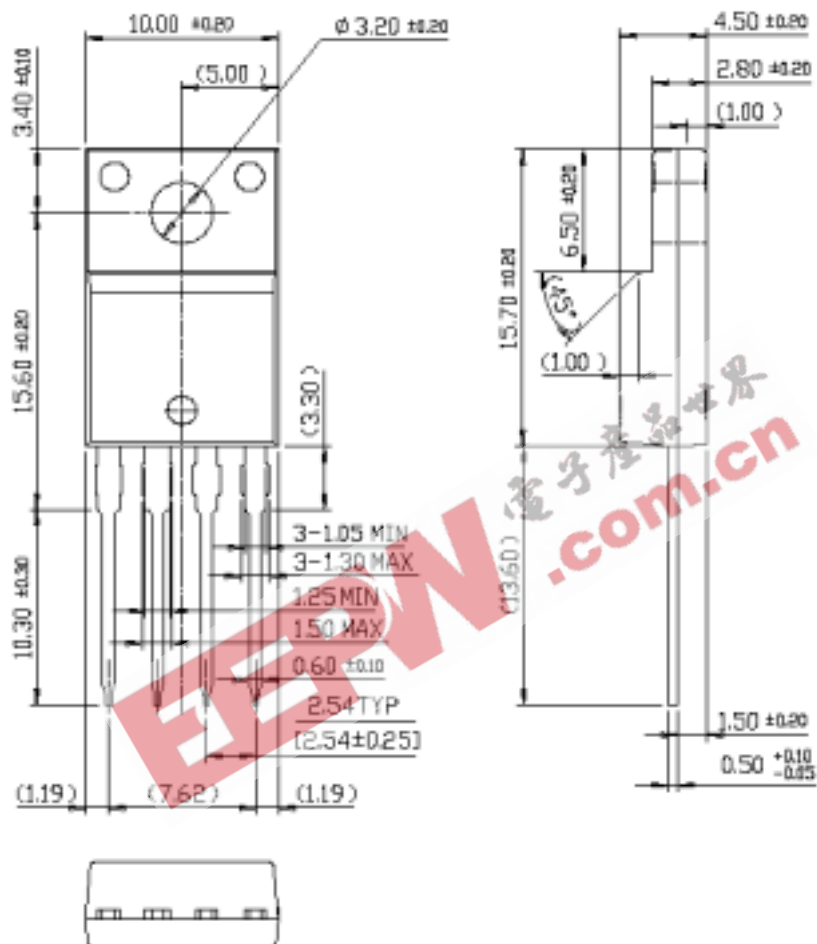

Ordering Information

Product Number	Package	Operating Temperature
KA78R33CTU	TO-220F-4L	-20°C to +80°C
KA78R05CTU		
KA78R08CTU		
KA78R09CTU		
KA78R12CTU		
KA78R15CTU		
KA78R33CYDTU	TO-220F-4L(Forming)	
KA78R05CYDTU		
KA78R09CYDTU		
KA78R33CTSTU	TO-220F-4L(Short Lead)	
KA78R05CTSTU		
KA78R08CTSTU		
KA78R09CTSTU		
KA78R12CTSTU		



 EEPW.com.cn 电子產品世界

DISCLAIMER

FAIRCHILD SEMICONDUCTOR RESERVES THE RIGHT TO MAKE CHANGES WITHOUT FURTHER NOTICE TO ANY PRODUCTS HEREIN TO IMPROVE RELIABILITY, FUNCTION OR DESIGN. FAIRCHILD DOES NOT ASSUME ANY LIABILITY ARISING OUT OF THE APPLICATION OR USE OF ANY PRODUCT OR CIRCUIT DESCRIBED HEREIN; NEITHER DOES IT CONVEY ANY LICENSE UNDER ITS PATENT RIGHTS, NOR THE RIGHTS OF OTHERS.

LIFE SUPPORT POLICY

FAIRCHILD'S PRODUCTS ARE NOT AUTHORIZED FOR USE AS CRITICAL COMPONENTS IN LIFE SUPPORT DEVICES OR SYSTEMS WITHOUT THE EXPRESS WRITTEN APPROVAL OF THE PRESIDENT OF FAIRCHILD SEMICONDUCTOR CORPORATION. As used herein:

1. Life support devices or systems are devices or systems which, (a) are intended for surgical implant into the body, or (b) support or sustain life, and (c) whose failure to perform when properly used in accordance with instructions for use provided in the labeling, can be reasonably expected to result in a significant injury of the user.
2. A critical component in any component of a life support device or system whose failure to perform can be reasonably expected to cause the failure of the life support device or system, or to affect its safety or effectiveness.