

# KA5x0165Rxx-SERIES

KA5H0165R/RN, KA5M0165R/RN, KA5L0165R/RN,  
KA5H0165RVN

Fairchild Power Switch(FPS)

## Features

- Precision Fixed Operating Frequency (100/67/50kHz )
- Low Start-up Current (Typ. 100uA)
- Pulse by Pulse Current Limiting
- Over Load Protection
- Over Voltage Protection (Min. 25V)
  - except KA5H0165RVN
- Internal Thermal Shutdown Function
- Under Voltage Lockout
- Internal High Voltage Sense FET
- Auto-Restart Mode

## Description

The Fairchild Power Switch(FPS) product family is specially designed for an off-line SMPS with minimal external components. The Fairchild Power Switch(FPS) consist of high voltage power SenseFET and current mode PWM IC. Included PWM controller features integrated fixed oscillator, under voltage lock out, leading edge blanking, optimized gate turn-on/turn-off driver, thermal shut down protection, over voltage protection, and temperature compensated precision current sources for loop compensation and fault protection circuitry compared to discrete MOSFET and controller or RCC switching converter solution. The Fairchild Power Switch(FPS) can reduce total component count, design size, weight and at the same time increase efficiency, productivity, and system reliability. It is well suited for cost effective design of flyback converters.

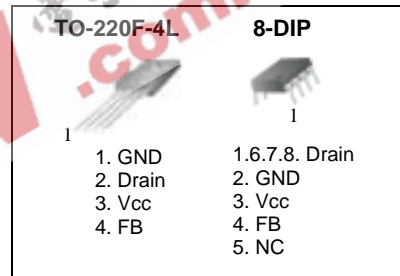

## Internal Block Diagram

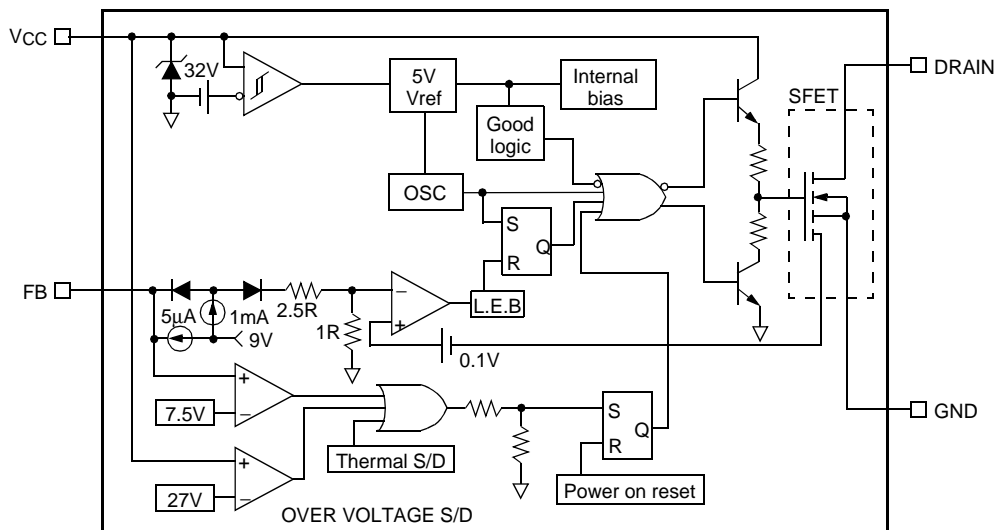

Rev.1.0.5

## Absolute Maximum Ratings

(Ta=25°C, unless otherwise specified)

Characteristic	Symbol	Value	Unit
Drain-Gate Voltage (RGS=1MΩ)	VDGR	650	V
Gate-Source (GND) Voltage	VGS	±30	V
Drain Current Pulsed <sup>(1)</sup>	IDM	4.0	ADC
Continuous Drain Current (TC=25°C)	ID	1.0	ADC
Continuous Drain Current (TC=100°C)	ID	0.7	ADC
Single Pulsed Avalanche Energy <sup>(2)</sup>	EAS	95	mJ
Maximum Supply Voltage	VCC,MAX	30	V
Analog Input Voltage Range	VFB	-0.3 to VSD	V
Total Power Dissipation	PD	40	W
	Derating	0.32	W/°C
Operating Junction Temperature.	TJ	+160	°C
Operating Ambient Temperature.	TA	-25 to +85	°C
Storage Temperature Range.	TSTG	-55 to +150	°C

### Note:

1. Repetitive rating: Pulse width limited by maximum junction temperature
2. L=24mH, starting Tj=25°C

EEPW.com.cn 电子产品世界

## Electrical Characteristics (SFET Part)

(Ta=25°C unless otherwise specified)

Parameter	Symbol	Condition	Min.	Typ.	Max.	Unit
Drain-Source Breakdown Voltage	BVDSS	V <sub>GS</sub> =0V, I <sub>D</sub> =50μA	650	-	-	V
Zero Gate Voltage Drain Current	I <sub>DSS</sub>	V <sub>DS</sub> =Max. Rating, V <sub>GS</sub> =0V	-	-	50	μA
		V <sub>DS</sub> =0.8Max. Rating, V <sub>GS</sub> =0V, T <sub>C</sub> =125°C	-	-	200	μA
Static Drain-Source on Resistance <sup>(Note)</sup>	R <sub>DS(ON)</sub>	V <sub>GS</sub> =10V, I <sub>D</sub> =0.5A	-	8	10	Ω
Forward Transconductance <sup>(Note)</sup>	g <sub>fs</sub>	V <sub>DS</sub> =50V, I <sub>D</sub> =0.5A	0.5	-	-	S
Input Capacitance	C <sub>iss</sub>	V <sub>GS</sub> =0V, V <sub>DS</sub> =25V, f=1MHz	-	250	-	pF
Output Capacitance	C <sub>oss</sub>		-	25	-	
Reverse Transfer Capacitance	C <sub>rss</sub>		-	10	-	
Turn on Delay Time	t <sub>d(on)</sub>	V <sub>DD</sub> =0.5B V <sub>DSS</sub> , I <sub>D</sub> =1.0A (MOSFET switching time is essentially independent of operating temperature)	-	12	-	nS
Rise Time	t <sub>r</sub>		-	4	-	
Turn Off Delay Time	t <sub>d(off)</sub>		-	30	-	
Fall Time	t <sub>f</sub>		-	10	-	
Total Gate Charge (Gate-Source+Gate-Drain)	Q <sub>g</sub>	V <sub>GS</sub> =10V, I <sub>D</sub> =1.0A, V <sub>DS</sub> =0.5B V <sub>DSS</sub> (MOSFET switching time is essentially independent of operating temperature)	-	-	21	nC
Gate-Source Charge	Q <sub>gs</sub>		-	3	-	
Gate-Drain (Miller) Charge	Q <sub>gd</sub>		-	9	-	

### Note:

1. Pulse test: Pulse width ≤ 300μS, duty cycle ≤ 2%

$$2. S = \frac{1}{R}$$

**Electrical Characteristics (Control Part)** (Continued)

(Ta=25°C unless otherwise specified)

Parameter	Symbol	Condition	Min.	Typ.	Max.	Unit
<b>UVLO SECTION</b>						
Start Threshold Voltage	VSTART	VFB=GND	14	15	16	V
Stop Threshold Voltage	VSTOP	VFB=GND	8.2	8.8	9.4	V
<b>OSCILLATOR SECTION</b>						
Initial Accuracy	FOSC	KA5H0165Rxx	90	100	110	kHz
Initial Accuracy	FOSC	KA5M0165Rx	61	67	73	kHz
Initial Accuracy	FOSC	KA5L0165Rx	45	50	55	kHz
Frequency Change With Temperature <sup>(2)</sup>	$\Delta F/\Delta T$	-25°C ≤ Ta ≤ +85°C	-	±5	±10	%
Maximum Duty Cycle	Dmax	KA5H0165Rxx	62	67	72	%
Maximum Duty Cycle	Dmax	KA5M0165Rx KA5L0165Rx	72	77	82	%
<b>FEEDBACK SECTION</b>						
Feedback Source Current	IFB	Ta=25°C, 0V ≤ Vfb ≤ 3V	0.7	0.9	1.1	mA
Shutdown Feedback Voltage	VSD	Vfb ≥ 6.5V	6.9	7.5	8.1	V
Shutdown Delay Current	Idelay	Ta=25°C, 3V ≤ Vfb ≤ VSD	4	5	6	μA
<b>REFERENCE SECTION</b>						
Output Voltage <sup>(1)</sup>	Vref	Ta=25°C	4.80	5.00	5.20	V
Temperature Stability <sup>(1)(2)</sup>	Vref/ΔT	-25°C ≤ Ta ≤ +85°C	-	0.3	0.6	mV/°C
<b>CURRENT LIMIT(SELF-PROTECTION)SECTION</b>						
Peak Current Limit	I <sub>OVER</sub>	Max. inductor current	0.53	0.6	0.67	A
<b>PROTECTION SECTION</b>						
Thermal Shutdown Temperature <sup>(1)</sup>	TSD	-	140	160	-	°C
Over Voltage Protection	VOVP	except KA5H0165RVN	25	27	29	V
<b>TOTAL STANDBY CURRENT SECTION</b>						
Start-up Current	ISTART	VCC=14V	-	100	170	μA
Operating Supply Current (Control Part Only)	IOP	VCC ≤ 28	-	7	12	mA

**Note:**

1. These parameters, although guaranteed, are not 100% tested in production
2. These parameters, although guaranteed, are tested in EDS (wafer test) process

## Typical Performance Characteristics

(These characteristic graphs are normalized at  $T_a=25^\circ\text{C}$ )

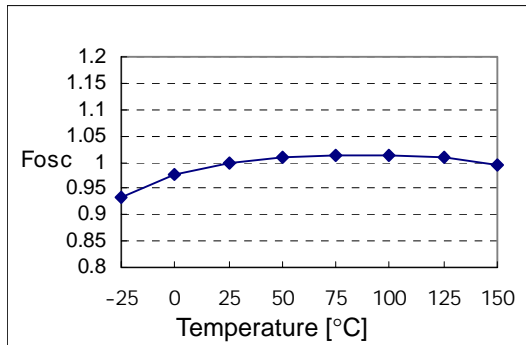

Figure 1. Operating Frequency

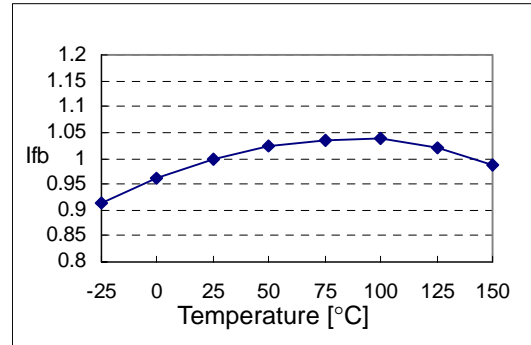

Figure 2. Feedback Source Current

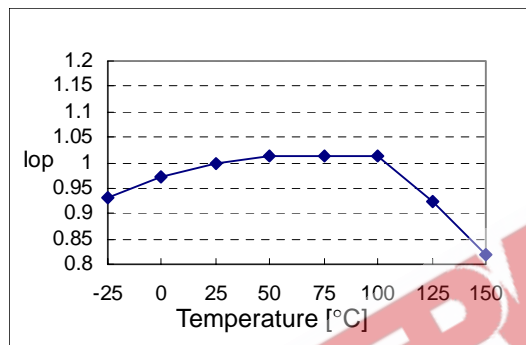

Figure 3. Operating Supply Current

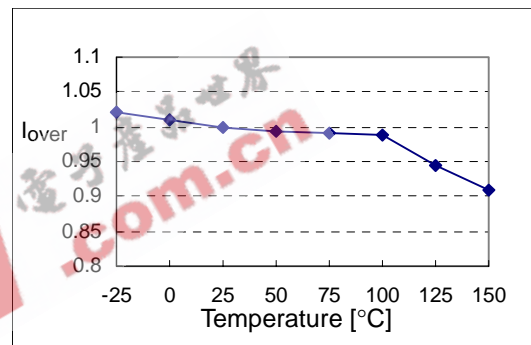

Figure 4. Peak Current Limit

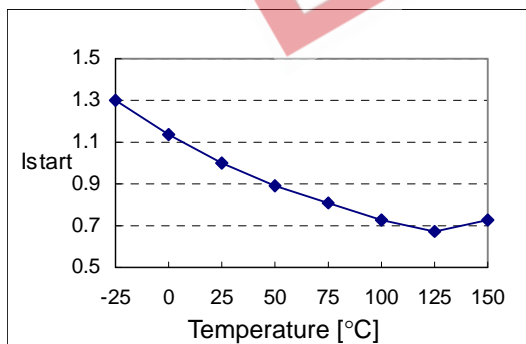

Figure 5. Start up Current

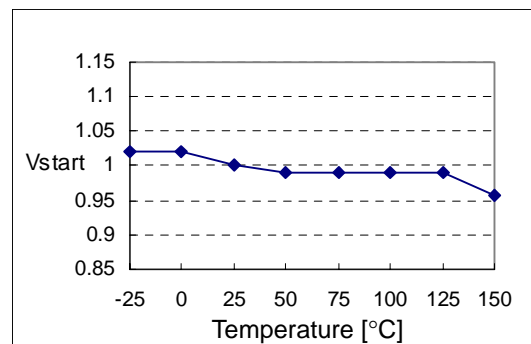

Figure 6. Start Threshold Voltage

**Typical Performance Characteristics** (Continued)

(These characteristic graphs are normalized at  $T_a=25^\circ\text{C}$ )

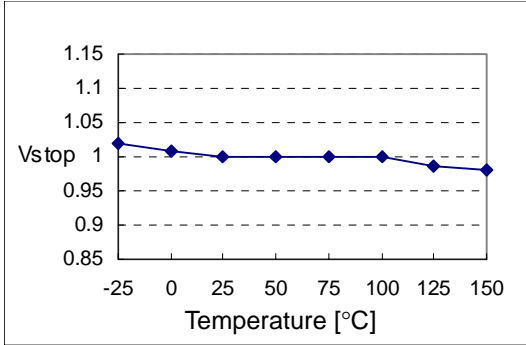

Figure 7. Stop Threshold Voltage

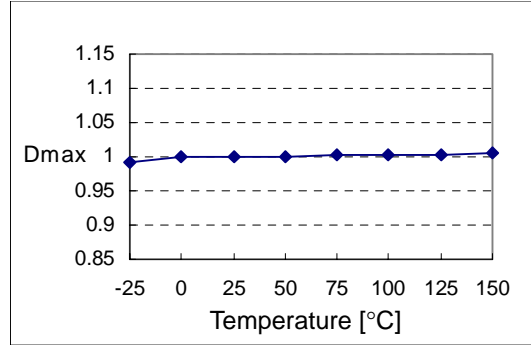

Figure 8. Maximum Duty Cycle

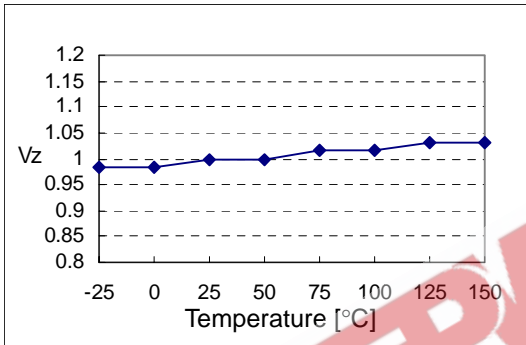

Figure 9. VCC Zener Voltage

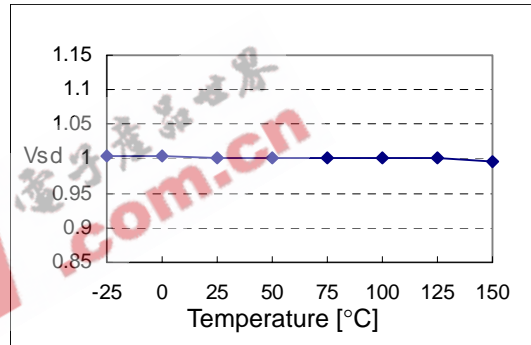

Figure 10. Shutdown Feedback Voltage

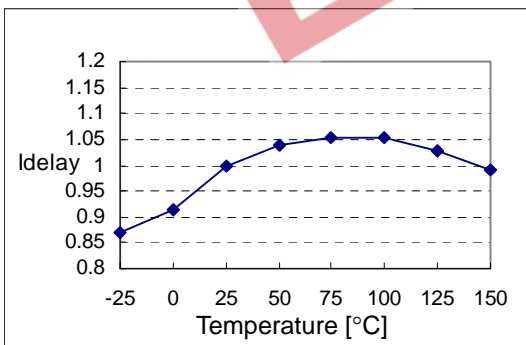

Figure 11. Shutdown Delay Current

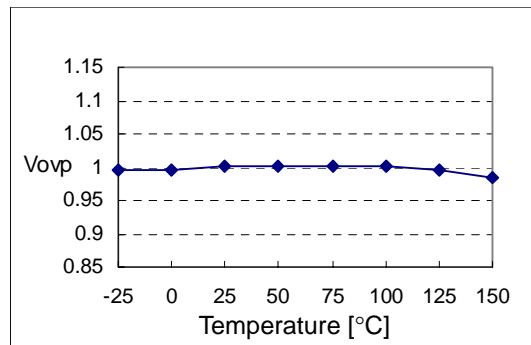

Figure 12. Over Voltage Protection

**Typical Performance Characteristics** (Continued)

(These characteristic graphs are normalized at  $T_a=25^\circ\text{C}$ )

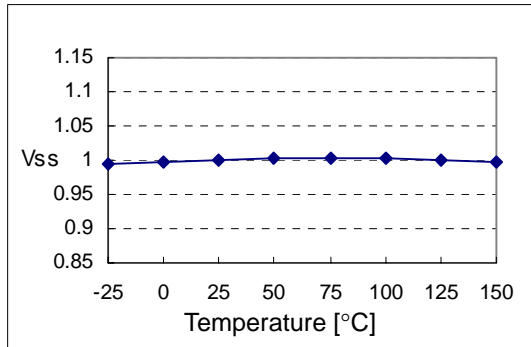

Figure 13. Soft Start Voltage

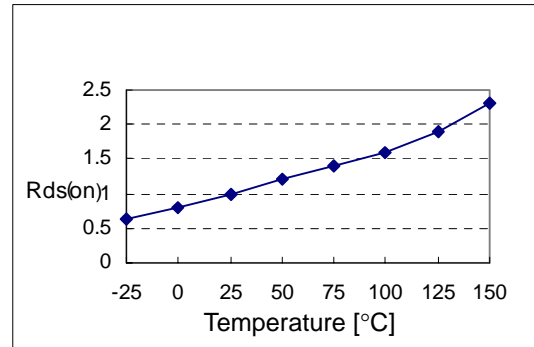
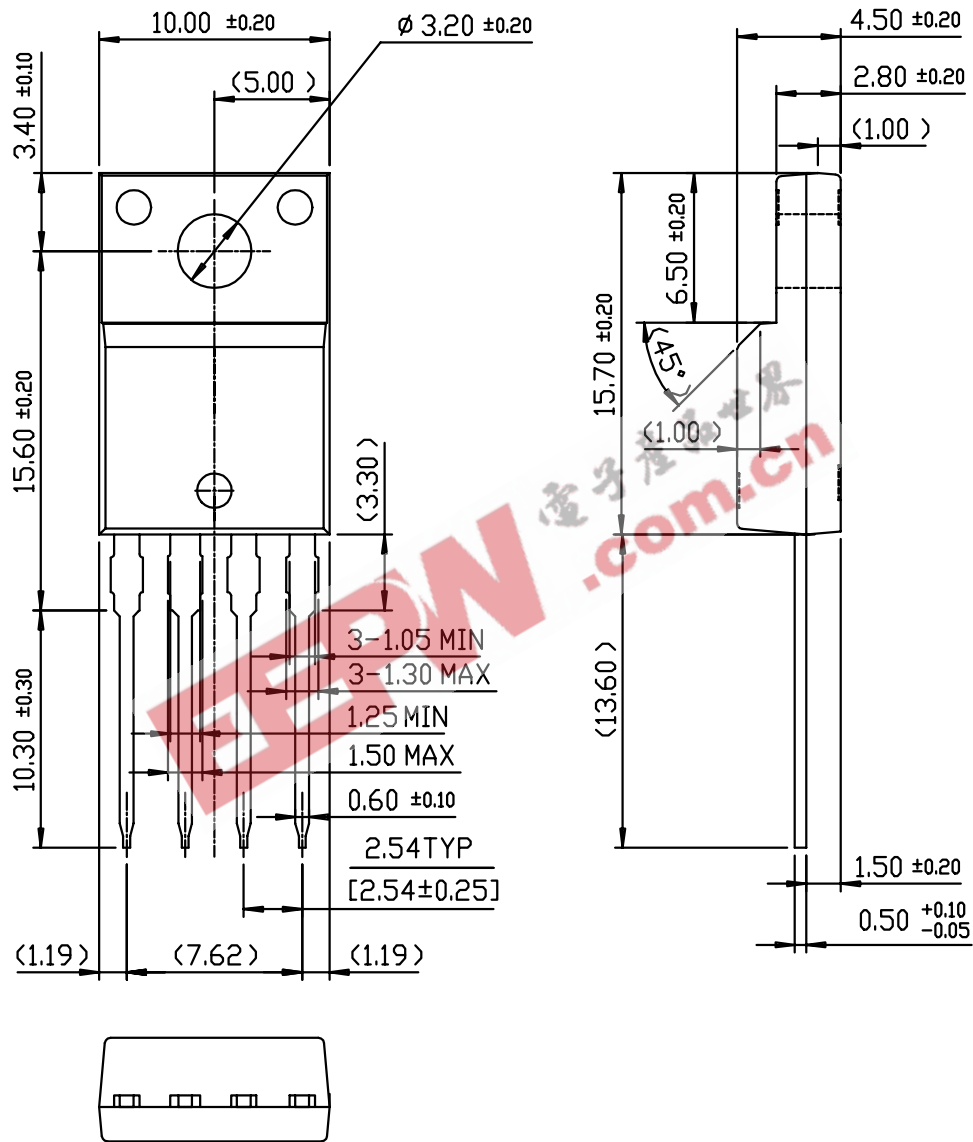

Figure 14. Static Drain-Source on Resistance

EEPW 电子产品世界  
.com.cn

# Package Dimensions

## TO-220F-4L







Package Dimensions (Continued)

8-DIP

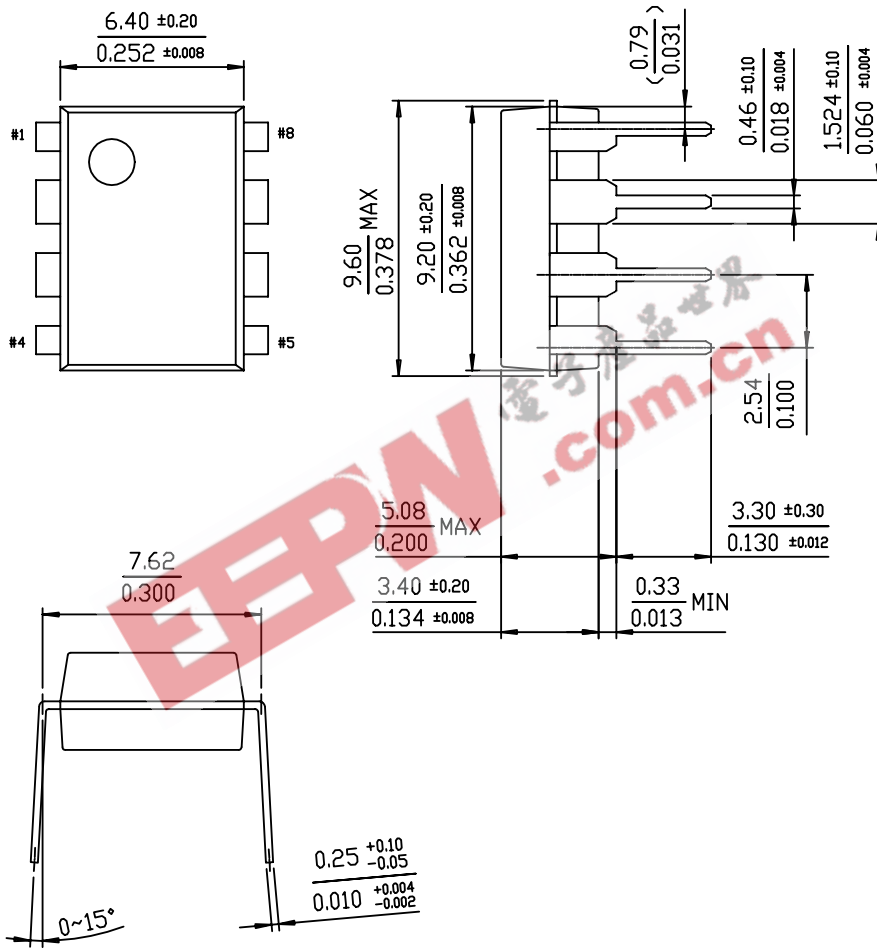

## Ordering Information

Product Number	Package	Marking Code	BVDSS	FOSC	RDS(on)
KA5H0165RTU	TO-220F-4L	5H0165R	650V	100kHz	8Ω
KA5H0165RYDTU	TO-220F-4L(Forming)				
KA5M0165RTU	TO-220F-4L	5M0165R	650V	67kHz	8Ω
KA5M0165RYDTU	TO-220F-4L(Forming)				
KA5L0165RTU	TO-220F-4L	5L0165R	650V	50kHz	8Ω
KA5L0165RYDTU	TO-220F-4L(Forming)				
KA5H0165RN	8-DIP	5H0165R	650V	100kHz	8Ω
KA5M0165RN	8-DIP	5M0165R	650V	67kHz	8Ω
KA5L0165RN	8-DIP	5L0165R	650V	50kHz	8Ω

Product Number	Package	Marking Code	BVDSS	FOSC	RDS(on)
KA5H0165RVN	8-DIP	5H0165RV	650V	100kHz	8Ω

TU : Non Forming Type

YDTU : Forming Type

EEPW 电子产品世界  
[www.eepw.com.cn](http://www.eepw.com.cn)



**DISCLAIMER**

FAIRCHILD SEMICONDUCTOR RESERVES THE RIGHT TO MAKE CHANGES WITHOUT FURTHER NOTICE TO ANY PRODUCTS HEREIN TO IMPROVE RELIABILITY, FUNCTION OR DESIGN. FAIRCHILD DOES NOT ASSUME ANY LIABILITY ARISING OUT OF THE APPLICATION OR USE OF ANY PRODUCT OR CIRCUIT DESCRIBED HEREIN; NEITHER DOES IT CONVEY ANY LICENSE UNDER ITS PATENT RIGHTS, NOR THE RIGHTS OF OTHERS.

**LIFE SUPPORT POLICY**

FAIRCHILD'S PRODUCTS ARE NOT AUTHORIZED FOR USE AS CRITICAL COMPONENTS IN LIFE SUPPORT DEVICES OR SYSTEMS WITHOUT THE EXPRESS WRITTEN APPROVAL OF THE PRESIDENT OF FAIRCHILD SEMICONDUCTOR CORPORATION. As used herein:

1. Life support devices or systems are devices or systems which, (a) are intended for surgical implant into the body, or (b) support or sustain life, and (c) whose failure to perform when properly used in accordance with instructions for use provided in the labeling, can be reasonably expected to result in a significant injury of the user.
2. A critical component in any component of a life support device or system whose failure to perform can be reasonably expected to cause the failure of the life support device or system, or to affect its safety or effectiveness.