

# Compact low voltage thick film thermal printhead (8dots / mm)

## KF2002-GF84A

KF2002-GF84A of low voltage thermal printheads have a 1.25-mm pitch connectors and reduced power supply circuit voltage requirements. This makes them useful for a wide range of applications, including CAT, FET-POS and naturally, handheld devices that demand printer heads which can operate with low supplied voltage.

### ●Applications

Mobile printers  
FET-POS printers  
Hand-held printers  
Debit printers

### ●Features

- 1) Both the circuit voltage and the voltage required during printing are 3.3V ; this allows the design of complete printer assemblies with energy-saving low power consumption.
- 2) KF2002-GF84A has a resistance value of 176Ω and can take a maximum current of 8.5V for printing. This is useful in applications where the peak voltage is restricted.
- 3) Because the connectors accept 1.25-mm pitch FFC (full flat cables) it is possible to reduce the size of printer mechanism control boards.
- 4) 2-inch, 3-inch and 4-inch series are available.

### ●External dimensions (Units : mm)

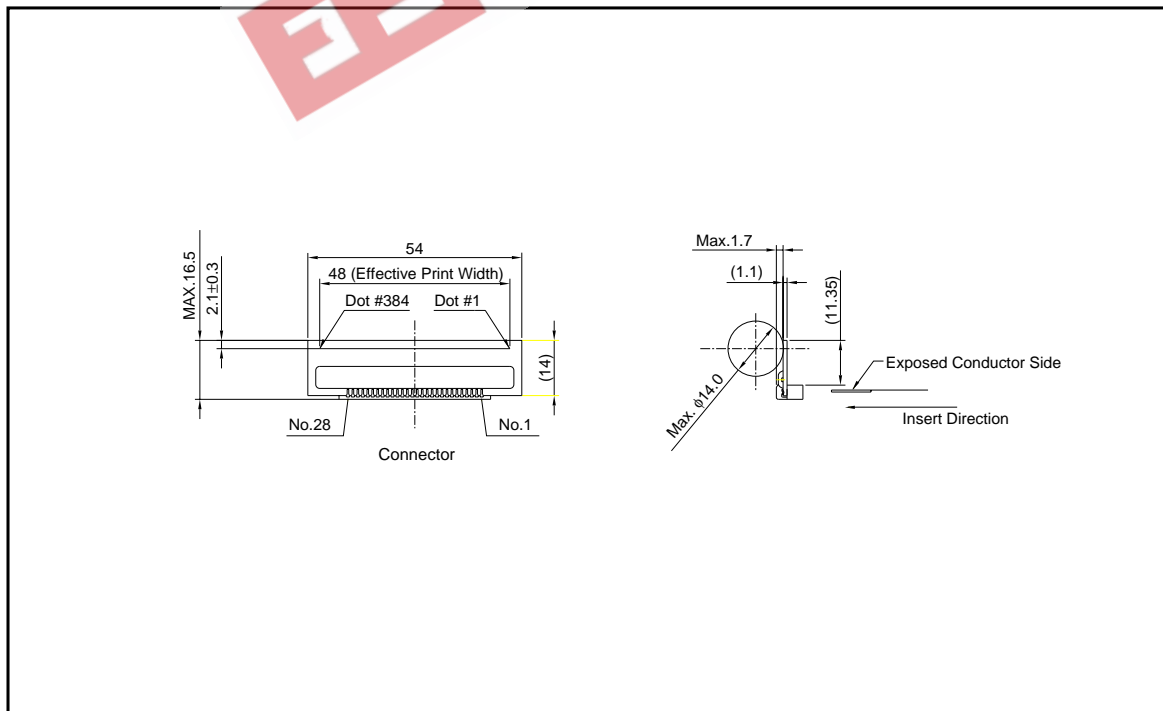

Printheads

●Equivalent circuit

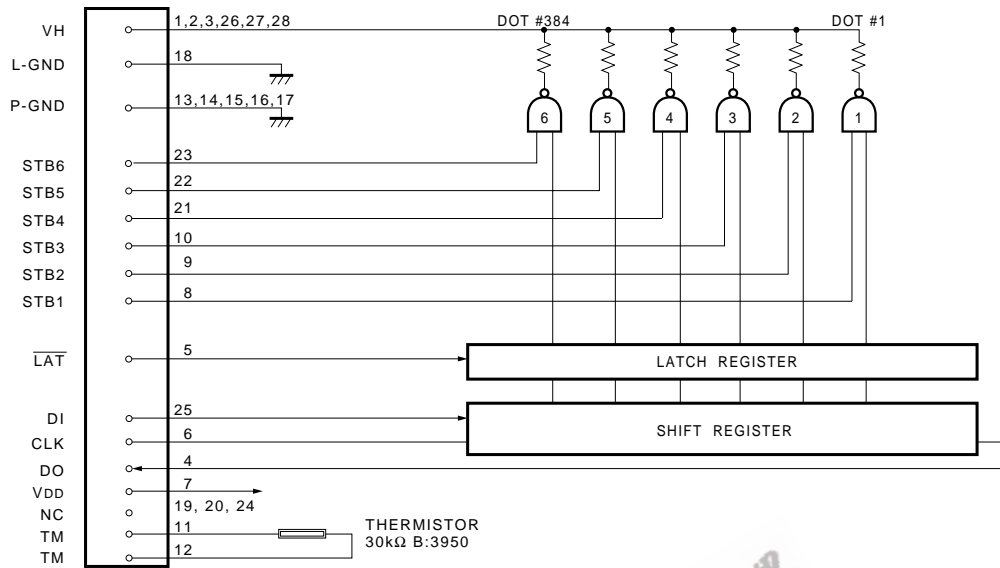

Fig.1

EEPW.com.cn 电子产品世界

Printheads

●Pin assignments

No.	Circuit	No.	Circuit
1	VH	15	P-GND
2	VH	16	P-GND
3	VH	17	P-GND
4	DO	18	L-GND
5	$\overline{\text{LAT}}$	19	NC
6	CLK	20	NC
7	V <sub>DD</sub>	21	STB4
8	STB1	22	STB5
9	STB2	23	STB6
10	STB3	24	NC
11	TM	25	DI
12	TM	26	VH
13	P-GND	27	VH
14	P-GND	28	VH

L-GND : LOGIC GROUND  
P-GND : POWER GROUND

●Timing chart

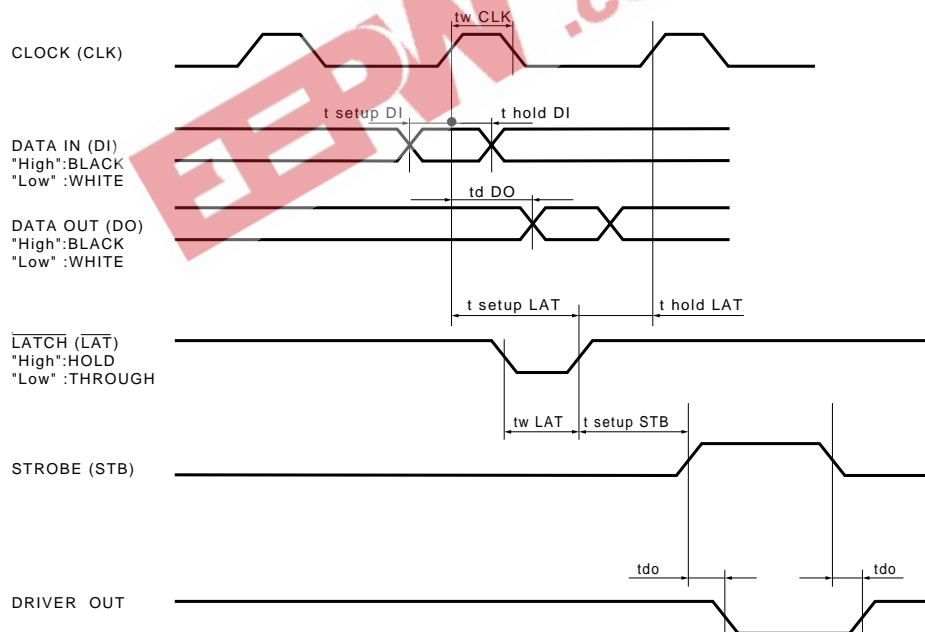

Fig.2

Printheads

●Characteristics

Parameter	Symbol	Typical	Unit
Effective printing width	—	48	mm
Dot pitch	—	0.125	mm
Total dot number	—	384	dots
Average resistance value	Rave	176	Ω
Applied voltage	V <sub>H</sub>	7.2	V
Applied power	P <sub>O</sub>	0.23	W/dot
Print cycle	SLT	1.25	ms
Pulse width	T <sub>ON</sub>	0.56	ms
Maximum number of dots energized simultaneously	—	64	dots
Maximum clock frequency	—	8	MHz
Maximum roller diameter	—	φ14.0	mm
Running life / pulse life	—	50/1×10 <sup>8</sup>	km/pulses
Operating temperature	—	0~50	°C

●Electrical characteristic curves

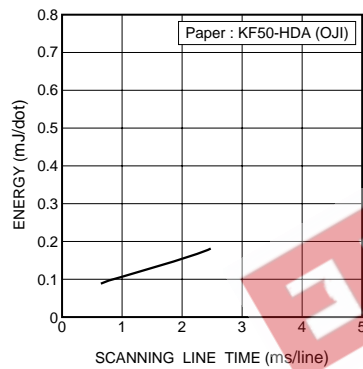

Fig.3 Adaptive speed chart

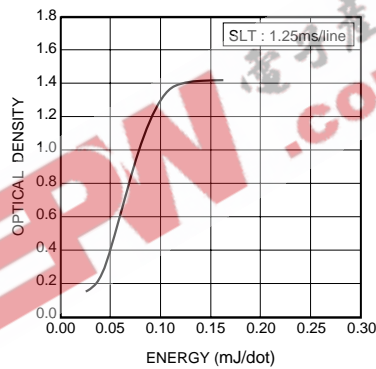

Fig.4 Representative density curve

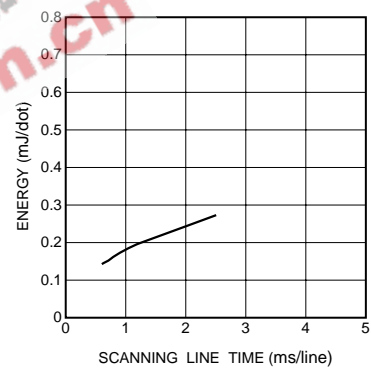

Fig.5 Maximum energy curve

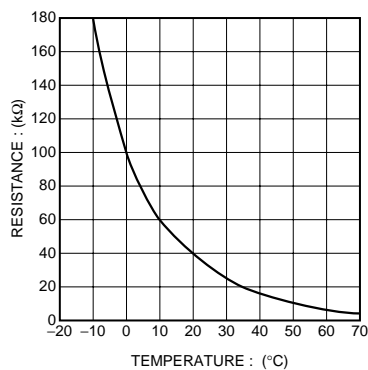

Fig.6 Thermistor curve

### Notes

- No technical content pages of this document may be reproduced in any form or transmitted by any means without prior permission of ROHM CO.,LTD.
- The contents described herein are subject to change without notice. The specifications for the product described in this document are for reference only. Upon actual use, therefore, please request that specifications to be separately delivered.
- Application circuit diagrams and circuit constants contained herein are shown as examples of standard use and operation. Please pay careful attention to the peripheral conditions when designing circuits and deciding upon circuit constants in the set.
- Any data, including, but not limited to application circuit diagrams information, described herein are intended only as illustrations of such devices and not as the specifications for such devices. ROHM CO.,LTD. disclaims any warranty that any use of such devices shall be free from infringement of any third party's intellectual property rights or other proprietary rights, and further, assumes no liability of whatsoever nature in the event of any such infringement, or arising from or connected with or related to the use of such devices.
- Upon the sale of any such devices, other than for buyer's right to use such devices itself, resell or otherwise dispose of the same, no express or implied right or license to practice or commercially exploit any intellectual property rights or other proprietary rights owned or controlled by
- ROHM CO., LTD. is granted to any such buyer.
- Products listed in this document use silicon as a basic material.  
Products listed in this document are no antiradiation design.

The products listed in this document are designed to be used with ordinary electronic equipment or devices (such as audio visual equipment, office-automation equipment, communications devices, electrical appliances and electronic toys).

Should you intend to use these products with equipment or devices which require an extremely high level of reliability and the malfunction of which would directly endanger human life (such as medical instruments, transportation equipment, aerospace machinery, nuclear-reactor controllers, fuel controllers and other safety devices), please be sure to consult with our sales representative in advance.

#### About Export Control Order in Japan

Products described herein are the objects of controlled goods in Annex 1 (Item 16) of Export Trade Control Order in Japan.

In case of export from Japan, please confirm if it applies to "objective" criteria or an "informed" (by MITI clause) on the basis of "catch all controls for Non-Proliferation of Weapons of Mass Destruction.