

KBPC10, 15, 25, 35 ...

10A / 15A / 25A / 35A SINGLE - PHASE SILICON BRIDGE

Features

- Surge overload 200 - 400 Amperes peak
- Low forward voltage drop
- Mounting Position: Any
- Electrically isolated base-180 Volts
- Solderable .25" FASTON terminals
- Materials used carries U/L recognition

TERMINALS / METAL

LEAD / METAL

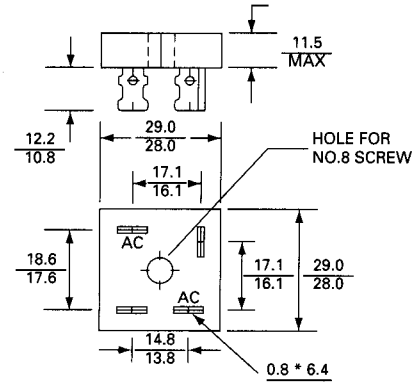

TERMINALS / PLASTIC

LEAD / PLASTIC

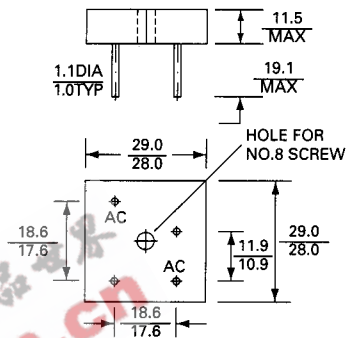

MAXIMUM RATINGS AND ELECTRICAL CHARACTERISTICS

Rating at 25 °C ambient temperature unless otherwise specified. Resistive or inductive load 60Hz

For capacitive load current by 20%.

Characteristic	KBPC10005	KBPC1001	KBPC1002	KBPC1004	KBPC1006	KBPC1008	KBPC1010	UNITS
Maximum Recurrent Peak Reverse Voltage	50	100	200	400	600	800	1000	V
Max RMS Bridge Input Voltage	35	70	140	280	420	560	700	V
Maximum Average Forward Rectified Output Current at $T_A = 55^\circ\text{C}$		10		15		25		A
Peak Forward Surge Current, 8.3 ms single half sine-wave superimposed on rated load	KBPC10		KBPC15		KBPC25		KBPC35	A
Maximum Forward Voltage Drop per element At 5.0/7.5/12.5/17.5A Peak	1.2							V
Maximum Reverse Current at Rated DC Blocking Voltage per element $T_A = 25^\circ\text{C}$	1.0							μA
Operating Temperature Range T_C	-55 to + 125							$^\circ\text{C}$
Storage Temperature Range T_A	-55 to + 150							$^\circ\text{C}$

NOTE: Also available on KBPC 10W/15W/25W/35W series.

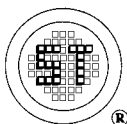

SEMTECH ELECTRONICS LTD.
(wholly owned subsidiary of HONEY TECHNOLOGY LTD.)



KBPC10, 15, 25, 35 ... 10A / 15A / 25A / 35A SINGLE - PHASE SILICON BRIDGE

RATING AND CHARACTERISTICS CURVES KBPC10/15/25/35 SERIES

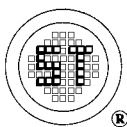
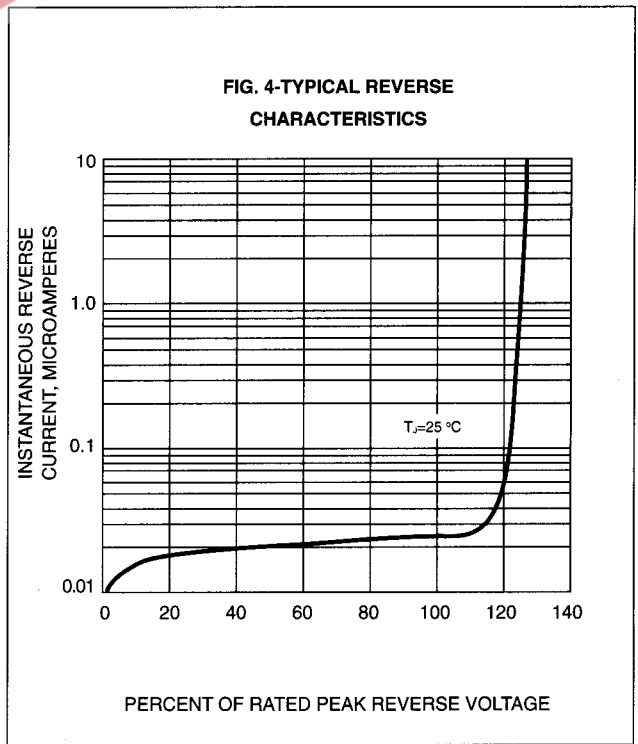
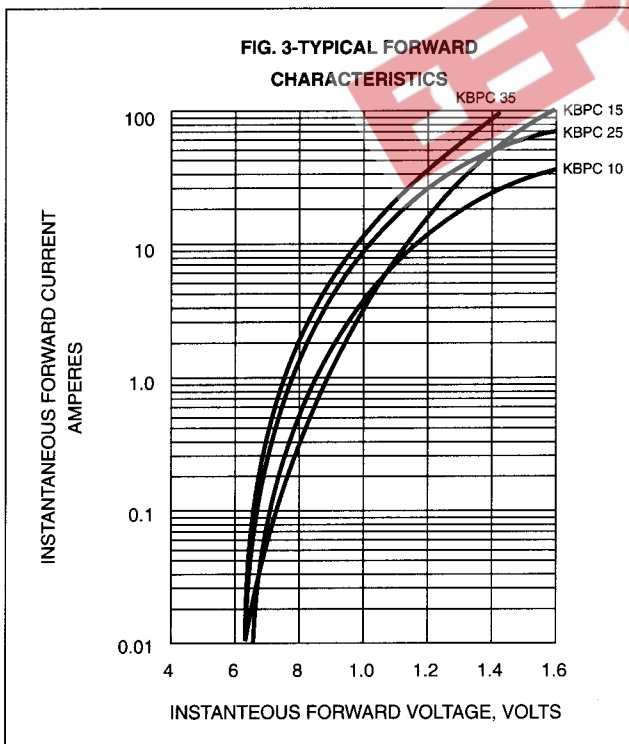
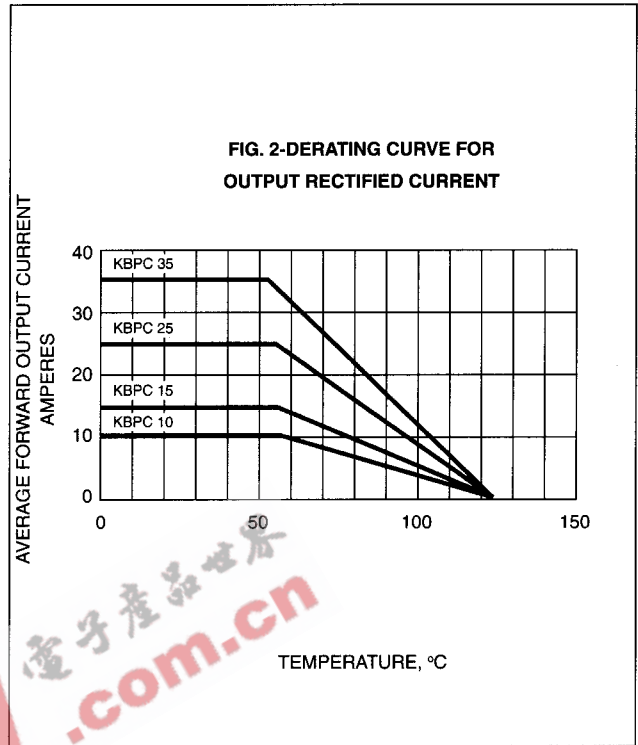
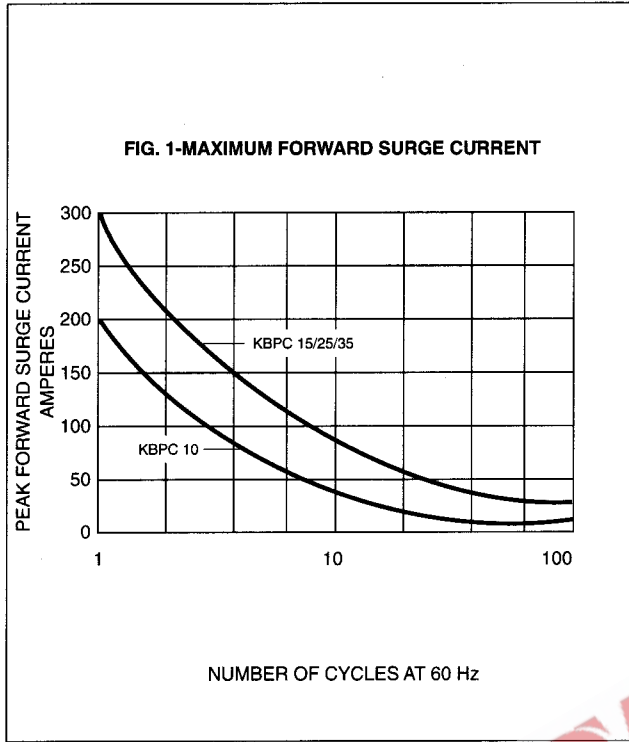

SEMTECH ELECTRONICS LTD.
(wholly owned subsidiary of HONEY TECHNOLOGY LTD.)

