

KA431/KA431A/KA431L

Programmable Shunt Regulator

Features

- Programmable Output Voltage to 36 Volts
- Low Dynamic Output Impedance 0.20 Typical
- Sink Current Capability of 1.0 to 100mA
- Equivalent Full-Range Temperature Coefficient of 50ppm/°C Typical
- Temperature Compensated for Operation Over Full Rated Operating Temperature Range
- Low Output Noise Voltage
- Fast Turn-on Response

Description

The KA431/KA431A/KA431L are three-terminal adjustable regulator series with a guaranteed thermal stability over applicable temperature ranges. The output voltage may be set to any value between VREF (approximately 2.5 volts) and 36 volts with two external resistors. These devices have a typical dynamic output impedance of 0.2W. Active output circuitry provides a very sharp turn on characteristic, making these devices excellent replacement for zener diodes in many applications.

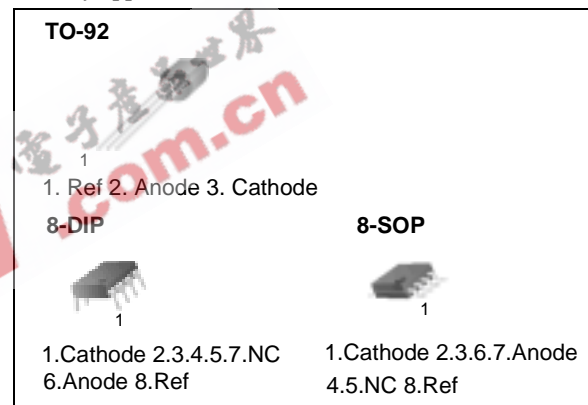

Internal Block Diagram

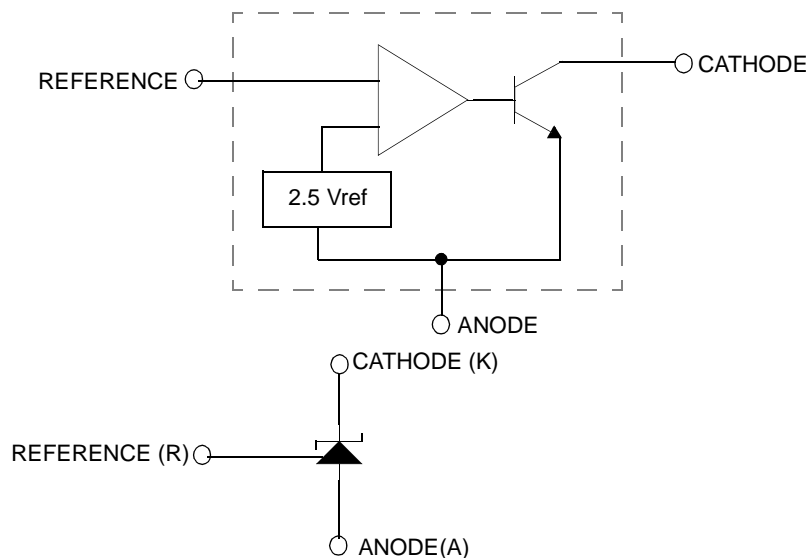

Absolute Maximum Ratings

(Operating temperature range applies unless otherwise specified.)

| Parameter | Symbol | Value | Unit |
|---|--------|-------------|----------|
| Cathode Voltage | VKA | 37 | V |
| Cathode Current Range (Continuous) | IKA | -100 ~ +150 | mA |
| Reference Input Current Range | IREF | 0.05 ~ +10 | mA |
| Power Dissipation D, Z Suffix Package DIP Package | PD | 770 1000 | mW mW |
| Junction Temperature | TJ | 150 | °C |
| Operating Temperature Range | TOPR | -25 ~ +85 | °C |
| Storage Temperature Range | TSTG | -65 ~ +150 | °C |

Recommended Operating Conditions

| Parameter | Symbol | Min. | Typ. | Max. | Unit |
|-----------------|--------|------|------|------|------|
| Cathode Voltage | VKA | VREF | - | 36 | V |
| Cathode Current | IKA | 1.0 | - | 100 | mA |

Electrical Characteristics

(T_A = +25°C, unless otherwise specified)

| Parameter | Symbol | Conditions | KA431 | | | KA431A | | | KA431L | | | Unit |
|---|-------------------------------------|--|-------|-------|-------|--------|-------|-------|--------|-------|-------|------|
| | | | Min. | Typ. | Max. | Min. | Typ. | Max. | Min. | Typ. | Max. | |
| Reference Input Voltage | V _{REF} | V _{KA} =V _{REF} , I _{KA} =10mA | 2.450 | 2.500 | 2.550 | 2.470 | 2.495 | 2.520 | 2.482 | 2.495 | 2.508 | V |
| Deviation of Reference Input Voltage Over-Temperature | ΔV _{REF} /ΔT | V _{KA} =V _{REF} , I _{KA} =10mA T _{MIN} ≤T _A ≤T _{MAX} | - | 4.5 | 17 | - | 4.5 | 17 | - | 4.5 | 17 | mV |
| Ratio of Change in Reference Input Voltage to the Change in Cathode Voltage | ΔV _{REF} /ΔV _{KA} | I _{KA} =10mA ΔV _{KA} =10V-V _{REF} | - | -1.0 | -2.7 | - | -1.0 | -2.7 | - | -1.0 | -2.7 | mV/V |
| | | ΔV _{KA} =36V-10V | - | -0.5 | -2.0 | - | -0.5 | -2.0 | - | -0.5 | -2.0 | |
| Reference Input Current | I _{REF} | I _{KA} =10mA, R ₁ =10kΩ,R ₂ =∞ | - | 1.5 | 4 | - | 1.5 | 4 | - | 1.5 | 4 | μA |
| Deviation of Reference Input Current Over Full Temperature Range | ΔI _{REF} /ΔT | I _{KA} =10mA, R ₁ =10kΩ,R ₂ =∞ T _A =Full Range | - | 0.4 | 1.2 | - | 0.4 | 1.2 | - | 0.4 | 1.2 | μA |
| Minimum Cathode Current for Regulation | I _{KA} (MIN) | V _{KA} =V _{REF} | - | 0.45 | 1.0 | - | 0.45 | 1.0 | - | 0.45 | 1.0 | mA |
| Off - Stage Cathode Current | I _{KA} (OFF) | V _{KA} =36V, V _{REF} =0 | - | 0.05 | 1.0 | - | 0.05 | 1.0 | - | 0.05 | 1.0 | μA |
| Dynamic Impedance | Z _{KA} | V _{KA} =V _{REF} , I _{KA} =1 to 100mA f ≥1.0kHz | - | 0.15 | 0.5 | - | 0.15 | 0.5 | - | 0.15 | 0.5 | Ω |

- T_{MIN} = -25°C, T_{MAX} = +85°C

Test Circuits

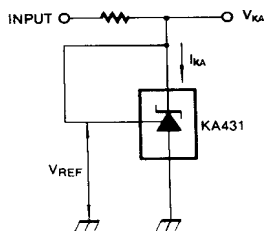

Figure 1. Test Circuit for $V_{KA} = V_{REF}$

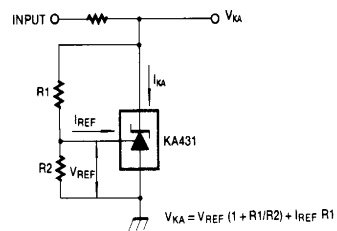

Figure 2. Test Circuit for $V_{KA} \geq V_{REF}$

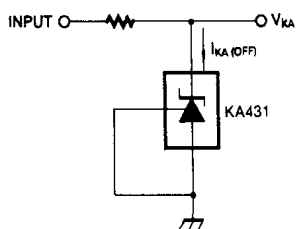

Figure 3. Test Circuit for $I_{KA(OFF)}$

EEPW 电子产品世界 .com.cn

Typical Performance Characteristics

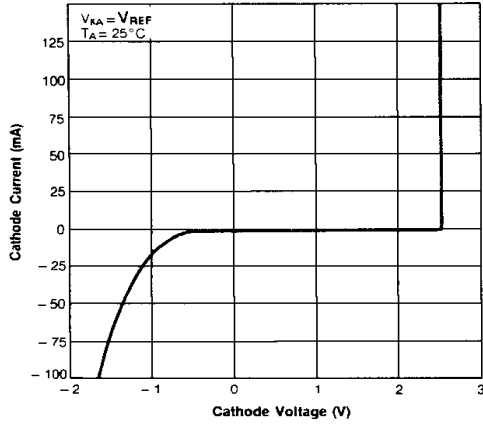

Figure 4. Cathode Current vs. Cathode Voltage

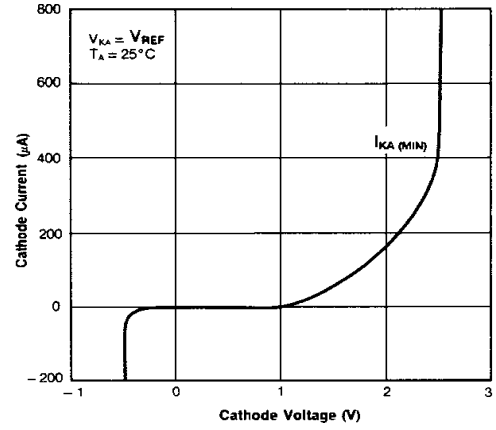

Figure 5. Cathode Current vs. Cathode Voltage

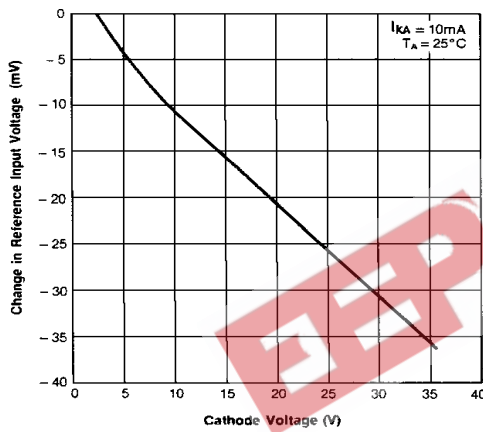

Figure 6. Change In Reference Input Voltage vs. Cathode Voltage

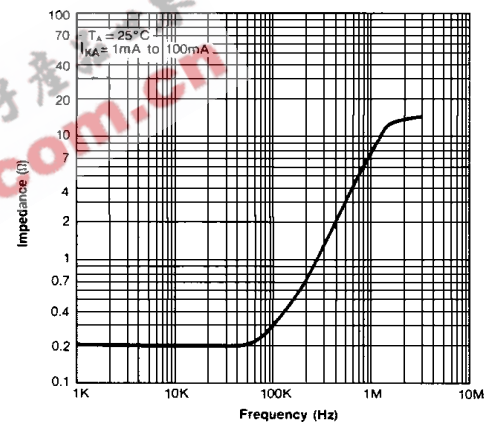

Figure 7. Dynamic Impedance Frequency

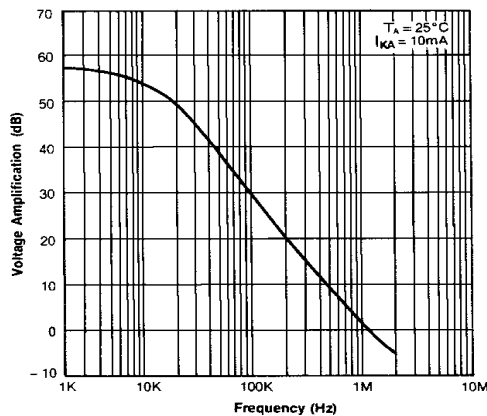

Figure 8. Small Signal Voltage Amplification vs. Frequency

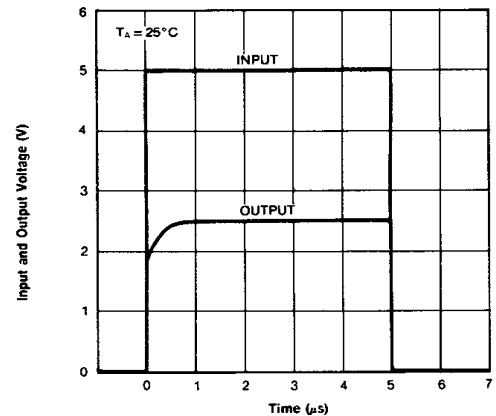

Figure 9. Pulse Response

Typical Performance Characteristics (Continued)

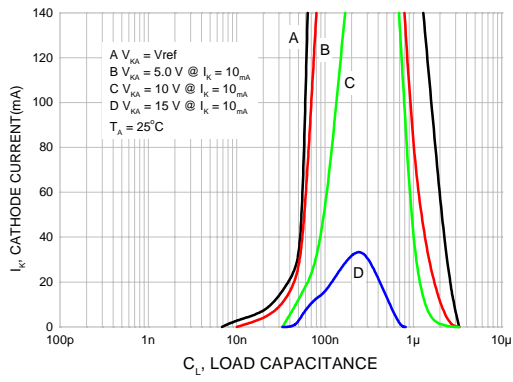

Figure 10. Stability Boundary Conditions

EEPW 电子产品世界 .com.cn

Typical Application

$$V_O = \left(1 + \frac{R_1}{R_2}\right)V_{ref}$$

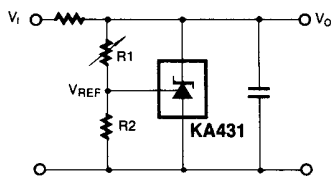

Figure 11. Shunt Regulator

$$V_O = V_{ref} \left(1 + \frac{R_1}{R_2}\right)$$

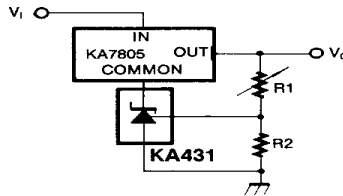

Figure 12. Output Control for Three-Terminal Fixed Regulator

$$V_O = \left(1 + \frac{R_1}{R_2}\right)V_{ref}$$

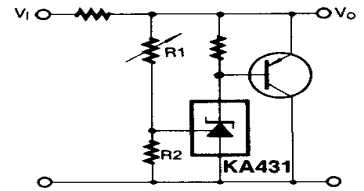

Figure 13. High Current Shunt Regulator

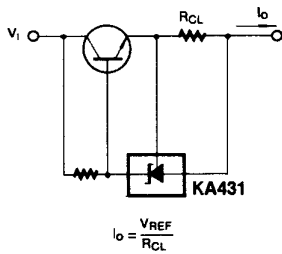

Figure 14. Current Limit or Current Source

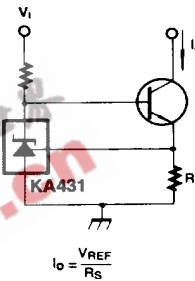

Figure 15. Constant-Current Sink

Mechanical Dimensions

Package

Dimensions in millimeters

TO-92

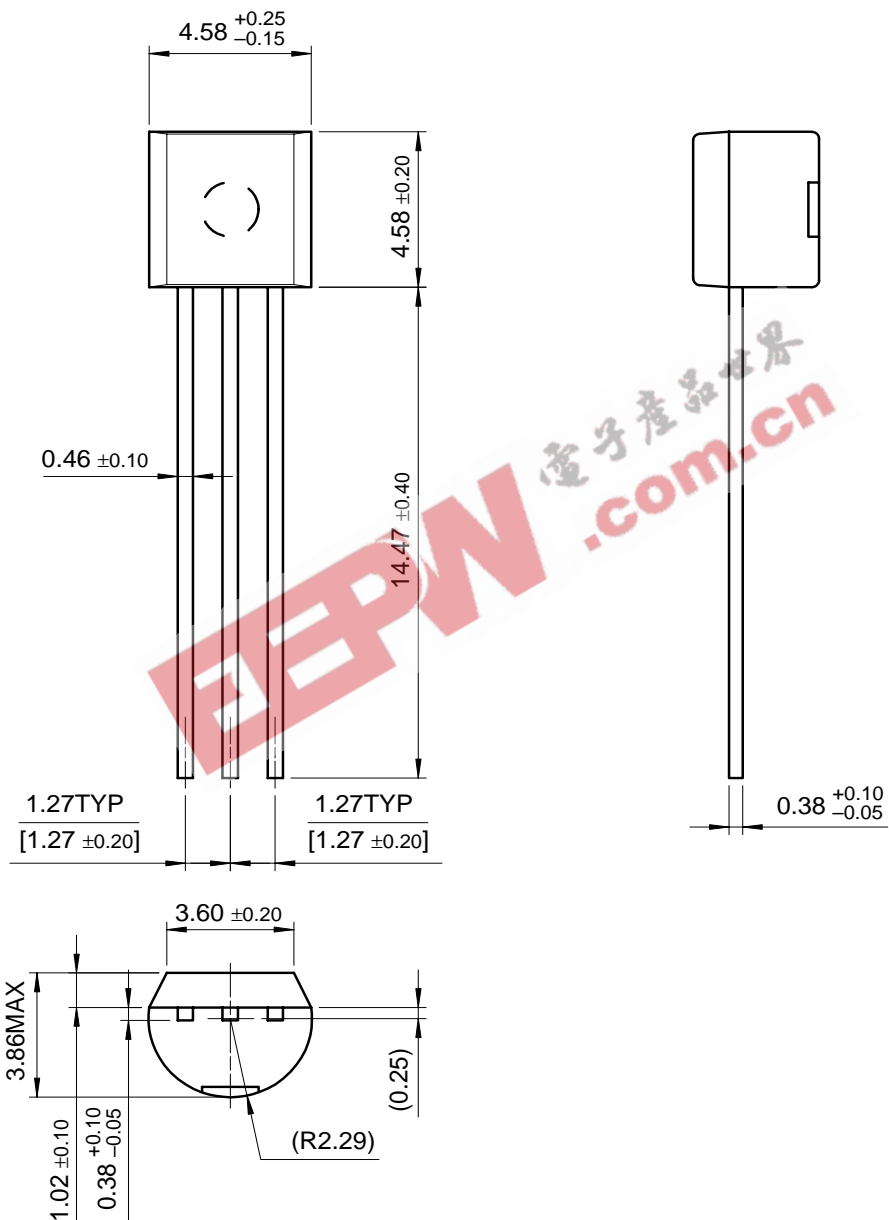

Mechanical Dimensions (Continued)

Package

Dimensions in millimeters

8-DIP

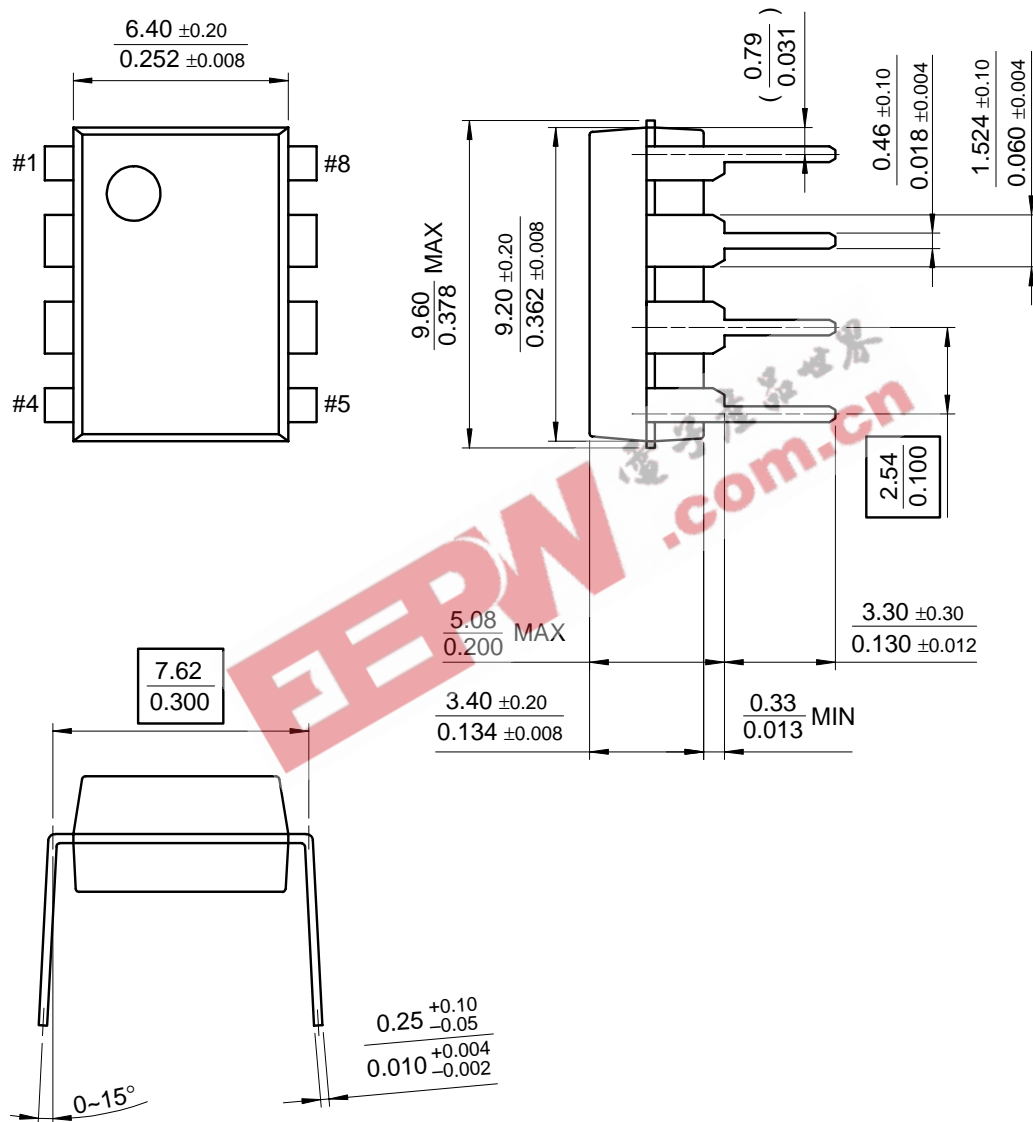

Mechanical Dimensions (Continued)

Package

Dimensions in millimeters

8-SOP

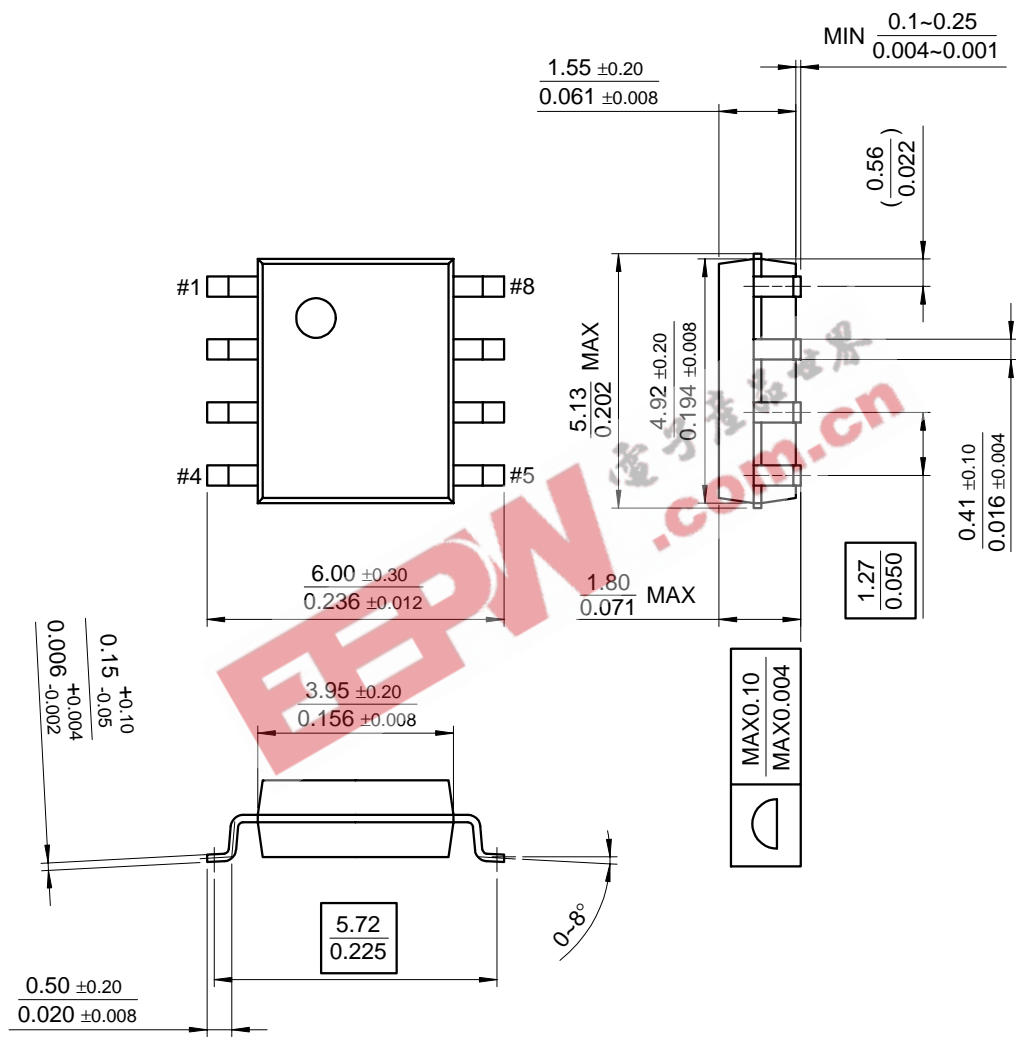

Ordering Information

| Product Number | Output Voltage Tolerance | Package | Operating Temperature |
|----------------|--------------------------|---------|-----------------------|
| KA431LZ | 0.5% | TO-92 | -25 ~ +85°C |
| KA431LD | | 8-SOP | |
| KA431AZ | 1% | TO-92 | |
| KA431AD | | 8-SOP | |
| KA431 | 2% | 8-DIP | |
| KA431Z | | TO-92 | |
| KA431D | | 8-SOP | |

EEPW 电子产品世界
.com.cn



DISCLAIMER

FAIRCHILD SEMICONDUCTOR RESERVES THE RIGHT TO MAKE CHANGES WITHOUT FURTHER NOTICE TO ANY PRODUCTS HEREIN TO IMPROVE RELIABILITY, FUNCTION OR DESIGN. FAIRCHILD DOES NOT ASSUME ANY LIABILITY ARISING OUT OF THE APPLICATION OR USE OF ANY PRODUCT OR CIRCUIT DESCRIBED HEREIN; NEITHER DOES IT CONVEY ANY LICENSE UNDER ITS PATENT RIGHTS, NOR THE RIGHTS OF OTHERS.

LIFE SUPPORT POLICY

FAIRCHILD'S PRODUCTS ARE NOT AUTHORIZED FOR USE AS CRITICAL COMPONENTS IN LIFE SUPPORT DEVICES OR SYSTEMS WITHOUT THE EXPRESS WRITTEN APPROVAL OF THE PRESIDENT OF FAIRCHILD SEMICONDUCTOR CORPORATION. As used herein:

1. Life support devices or systems are devices or systems which, (a) are intended for surgical implant into the body, or (b) support or sustain life, and (c) whose failure to perform when properly used in accordance with instructions for use provided in the labeling, can be reasonably expected to result in a significant injury of the user.
2. A critical component in any component of a life support device or system whose failure to perform can be reasonably expected to cause the failure of the life support device or system, or to affect its safety or effectiveness.