

1. Description

The KEL-209A is a high-power GaAlAs IRED mounted in a TO-18 metal stem with clear epoxy encapsulation, providing wide beam angle.

2. Features

- High Output Power
- Wide Beam Angle $\pm 90^\circ$
- Epoxy Potting Type

3. Applications

- Optical Switches
- Transportation Sensor
- Toys

4. Package Outline

ALL DIMENSIONS IN MILLIMETERS

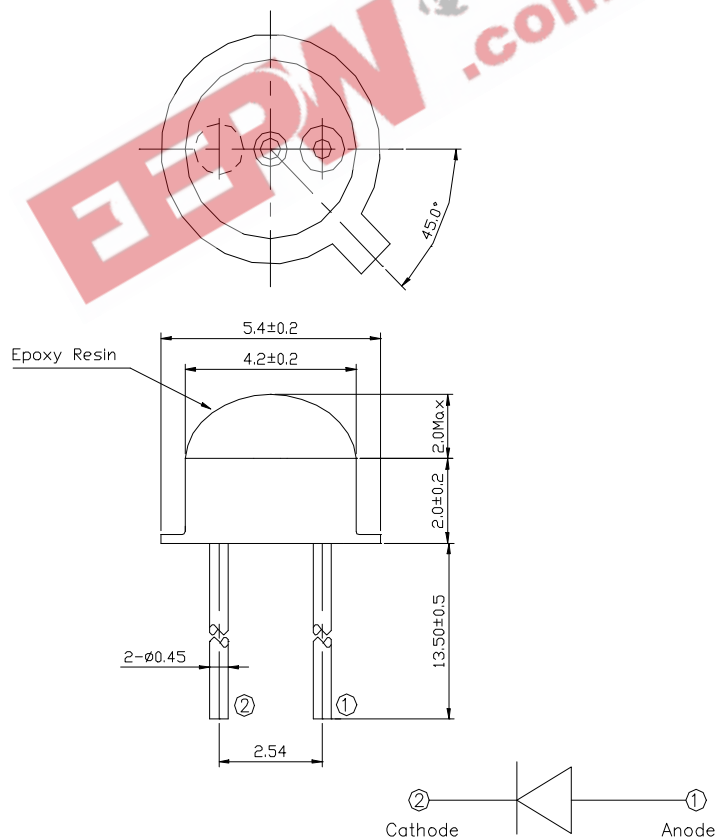

Typical Characteristics

Power dissipation Vs Ambient temperature

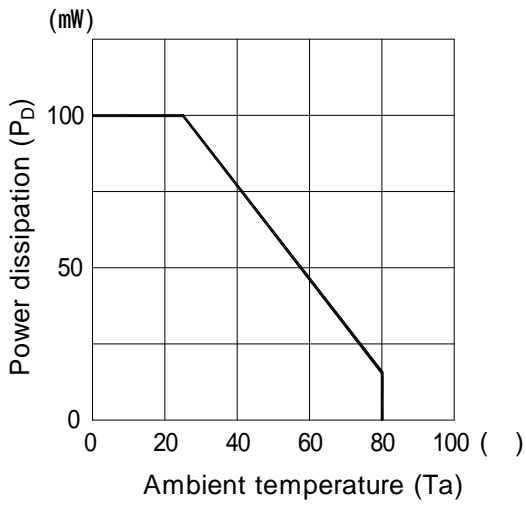

Radiant intensity Vs Forward current

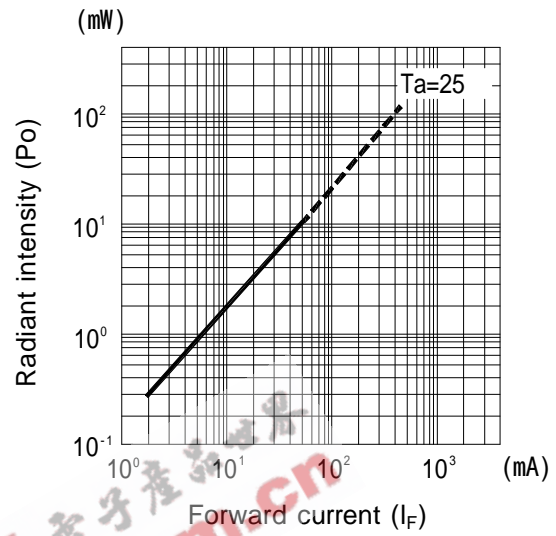

Relative radiant intensity Vs Ambient temperature

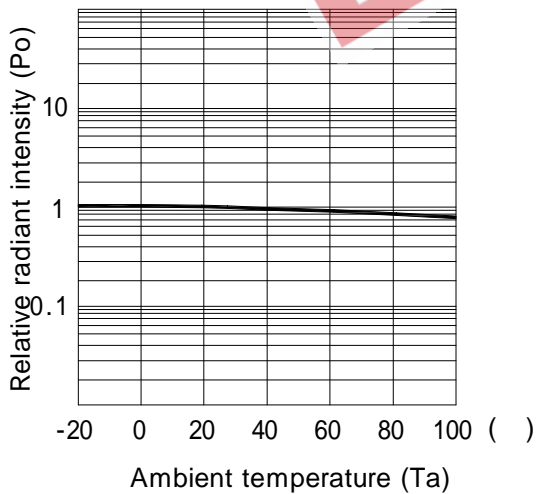

Relative intensity Vs Wavelength

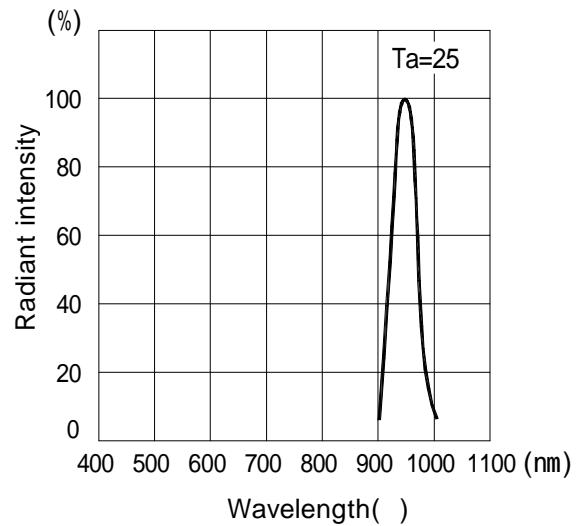

Typical Characteristics

Forward current Vs Forward voltage

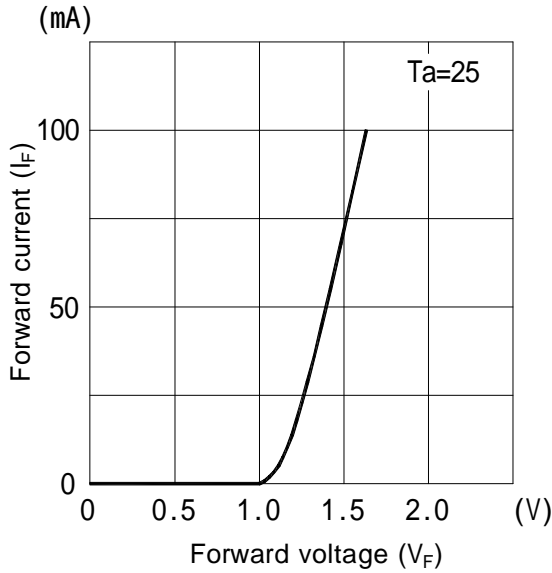

Sensitivity diagram Vs Angular displacement

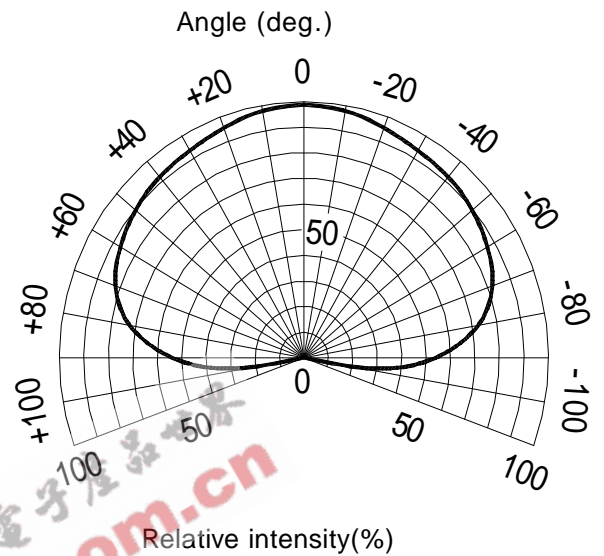

Relative radiant intensity Vs Distance

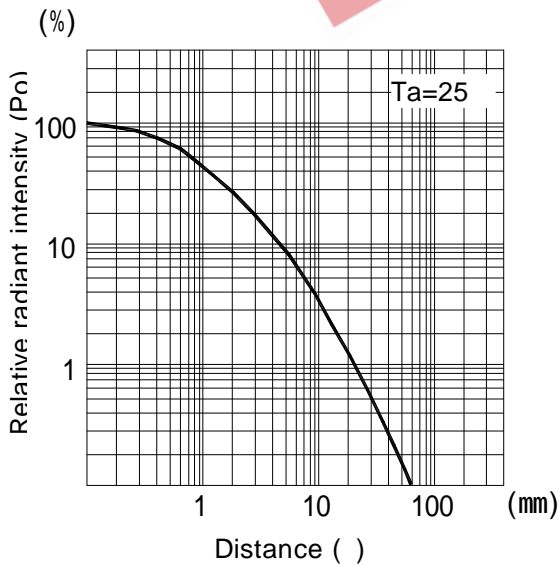

Relative radiant intensity Vs Distance (Drawing of measurement system)

