

KA239/KA239A, KA339/KA339A KA3302, KA2901

Quad Comparator

Features

- Single or Dual Supply Operation
- Wide Range of Supply Voltage
KA239/KA239A, KA339/KA339A, KA2901 : 2 ~ 36V (or $\pm 1 \sim \pm 18V$)
KA3302 : 2 ~ 28V (or $\pm 1 \sim \pm 14V$)
- Low Supply Current Drain 800 μA Typ.
- Open Collector Outputs for Wired and Connectors
- Low Input Bias Current 25nA Typ.
- Low Input Offset Current $\pm 2.3nA$ Typ.
- Low Input Offset Voltage $\pm 1.4mV$ Typ.
- Input Common Mode Voltage Range Includes Ground.
- Low Output Saturation Voltage
- Output Compatible With TTL, DTL and MOS Logic System

Description

The KA239/KA239A, KA339/KA339A, KA3302, KA2901 consist of four independent voltage comparators designed to operate from single power supply over a wide voltage range.

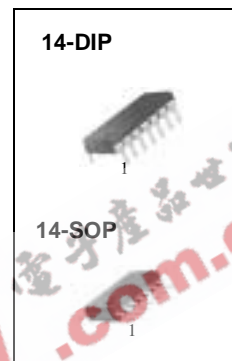

Internal Block Diagram

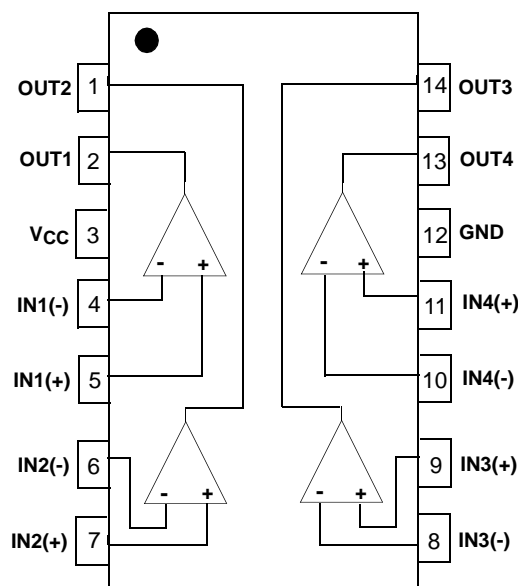

Schematic Diagram

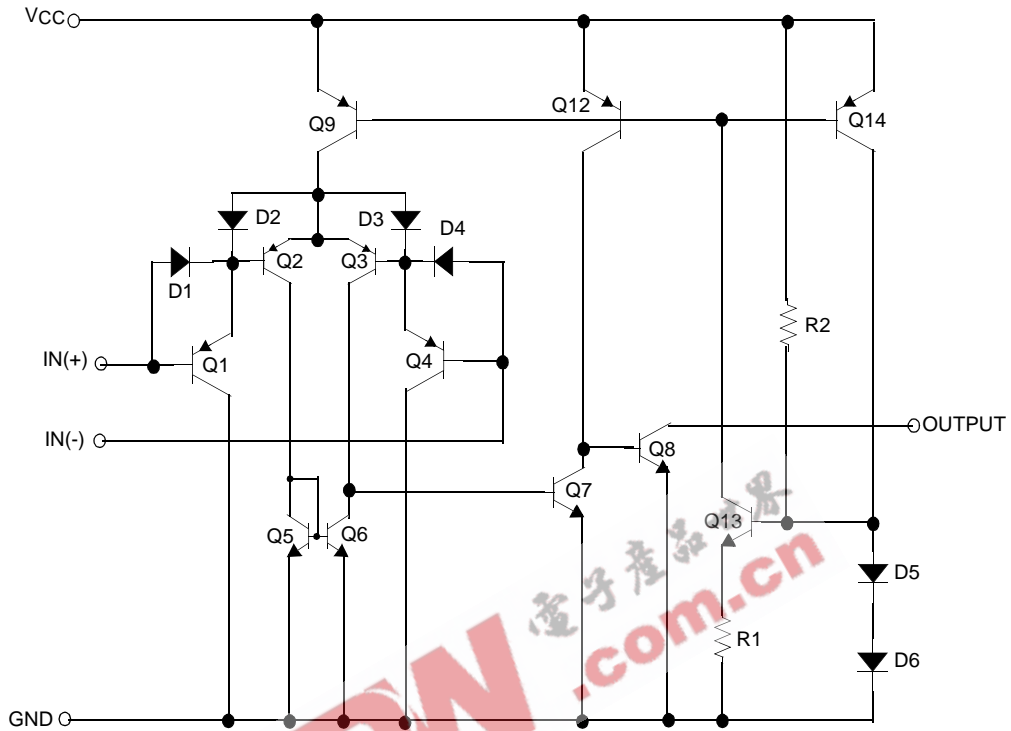

Absolute Maximum Ratings

Parameter	Symbol	Value	Unit
Supply Voltage	VCC	±18 or 36	V
Supply Voltage Only KA3302	VCC	±14 or 28	V
Differential Input Voltage	V _{I(DIFF)}	36	V
Differential Input Voltage Only KA3302	V _{I(DIFF)}	28	V
Input Voltage	V _I	-0.3 to +36	V
Input Voltage Only KA3302	V _I	-0.3 to +28	V
Output Short Circuit to GND	-	Continuous	-
Power Dissipation	P _D	570	mW
Operating Temperature KA339/KA339A KA239/KA239A KA2901/KA3302	T _{OPR}	0 ~ +70 -25 ~ +85 -40 ~ +85	°C
Storage Temperature	T _{STG}	-65 ~ +150	°C

Electrical Characteristics

($V_{CC} = 5V$, $T_A = 25^\circ C$, unless otherwise specified)

Parameter	Symbol	Conditions	KA239A/KA339A			KA239/KA339			Unit
			Min.	Typ.	Max.	Min.	Typ.	Max.	
Input Offset Voltage	V_{IO}	$V_{O(P)} = 1.4V$, $R_S = 0\Omega$	-	1	2	-	1.4	5	mV
		Note1	-	-	4.0	-	-	9.0	
Input Offset Current	I_{IO}	$I_{IN(+)} - I_{IN(-)}$, $V_{CM} = 0V$	-	2.3	50	-	2.3	50	nA
		Note1	-	-	150	-	-	150	
Input Bias Current	I_{BIAS}	$V_{CM} = 0V$	-	57	250	-	57	250	nA
		Note1	-	-	400	-	-	400	
Input Common Mode Voltage Range	$V_{I(R)}$	$V_{CC} = 30V$	0	-	$V_{CC}-1.5$	0	-	$V_{CC}-1.5$	V
		Note1	0	-	$V_{CC}-2$	0	-	$V_{CC}-2$	
Supply Current	I_{CC}	$V_{CC} = 5V$, $R_L = \infty$	-	1.1	2.0	-	1.1	2.0	mA
Voltage Gain	G_V	$V_{CC} = 15V$, $R_L \geq 15k\Omega$ (for large swing)	50	200	-	50	200	-	V/mV
Large Signal Response Time	T_{LRES}	$V_I = \text{TTL Logic Swing}$ $V_{REF} = 1.4V$, $V_{RL} = 5V$, $R_L = 5.1k\Omega$ (Note2)	-	300	-	-	300	-	ns
Response Time	T_{RES}	$V_{RL} = 5V$, $R_L = 5.1k\Omega$ (Note2)	-	1.3	-	-	1.3	-	μs
Output Sink Current	I_{SINK}	$V_{I(-)} \geq 1V$, $V_{I(+)} = 0V$, $V_{O(P)} \leq 1.5V$	6	18	-	6	18	-	mA
Output Saturation Voltage	V_{SAT}	$V_{I(-)} \geq 1V$, $V_{I(+)} = 0V$ $I_{SINK} = 4mA$	-	140	400	-	140	400	mV
		Note1	-	-	700	-	-	700	
Output Leakage Current	$I_{o(LKG)}$	$V_{I(-)} = 0V$	-	0.1	-	-	0.1	-	nA
		$V_{I(+)} = 1V$	-	-	1.0	-	-	1.0	μA
Differential Voltage	$V_{I(DIFF)}$	Note1	-	-	36	-	-	36	V

Note:

- KA339 / KA339A: $0 \leq T_A \leq +70^\circ C$
KA239 / KA239A: $-25 \leq T_A \leq +85^\circ C$
KA2901 / KA3302: $-40 \leq T_A \leq +85^\circ C$
- These parameters, although guaranteed, are not 100% tested in production.

Electrical Characteristics (Continued)

(VCC = 5V, TA = 25°C, unless otherwise specified)

Parameter	Symbol	Conditions	KA2901			KA3302			Unit	
			Min.	Typ.	Max.	Min.	Typ.	Max.		
Input Offset Voltage	V _{IO}	VO(P) = 1.4V, RS = 0Ω	-	2	7	-	2	20	mV	
		Note1	-	9	15	-	-	40		
Input Offset Current	I _{IO}		-	2.3	50	-	3	100	nA	
		Note1	-	50	200	-	-	300		
Input Bias Current	I _{BIAS}		-	57	250	-	57	250	nA	
		Note1	-	200	500	-	-	1000		
Input Common Mode Voltage Range	V _{I(R)}	KA2901, VCC = 30V KA3302, VCC = 28V	0	-	VCC - 1.5	0	-	VCC - 1.5	V	
		Note1	0	-	VCC - 2	0	-	VCC - 2		
Supply Current	I _{CC}	RL = ∞, VCC = 5V	-	1.1	2.0	-	1.1	2.0	mA	
		RL = ∞, VCC = 30V (KA3302, VCC = 28V)	-	1.6	2.5	-	1.6	2.5		
Voltage Gain	G _V	VCC = 15V, RL ≥ 15kΩ (for large swing)	25	100	-	2	30	-	V/mV	
Large Signal Response Time	TLRES	V _I = TTL Logic Swing VREF = 1.4V, VRL = 5V, RL = 5.1kΩ (Note2)	-	300	-	-	300	-	ns	
Response Time	TRES	VRL = 5V, RL = 5.1kΩ (Note2)	-	1.3	-	-	1.3	-	μs	
Output Sink Current	I _{SINK}	V _{I(-)} ≥ 1V, V _{I(+)} = 0V, V _{O(P)} ≤ 1.5V	6	18	-	6	18	-	mA	
Output Saturation Voltage	V _{SAT}	V _{I(-)} ≥ 1V, V _{I(+)} = 0V	-	140	400	-	140	400	mV	
		I _{SINK} = 4mA	Note1	-	-	700	-	-		700
Output Leakage Current	I _{O(LKG)}	V _{I(-)} = 0V								
		V _{I(+)} = 1V	VO(P) = 5V	-	0.1	-	-	0.1	-	nA
			VO(P) = 30V	-	-	1.0	-	-	1.0	μA
Differential Voltage	V _{I(DIFF)}	-	Note1	-	-	36	-	-	28	V

Note:

- KA339 / KA339A: $0 \leq T_A \leq +70^\circ\text{C}$
KA239 / KA239A: $-25 \leq T_A \leq +85^\circ\text{C}$
KA2901 / KA3302: $-40 \leq T_A \leq +85^\circ\text{C}$
- These parameters, although guaranteed, are not 100% tested in production.

Typical Performance Characteristics

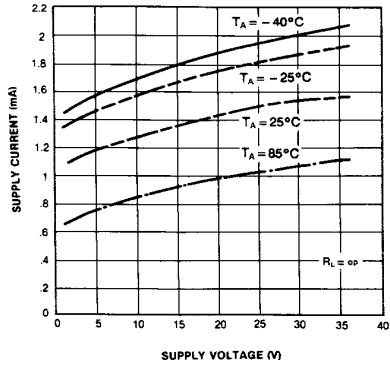

Figure 1. Supply Current vs Supply Voltage

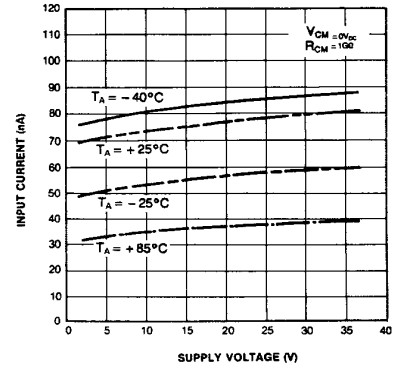

Figure 2. Input Current vs Supply Voltage

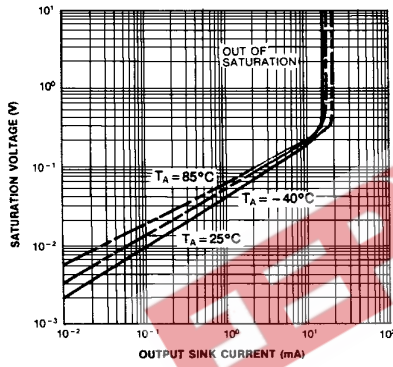

Figure 3. Output Saturation Voltage vs Sink Current

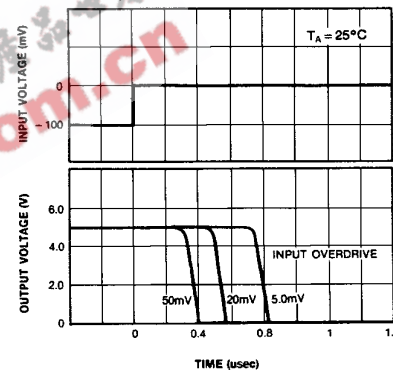

Figure 4. Response Time for Various Input Overdrive-Negative Transition

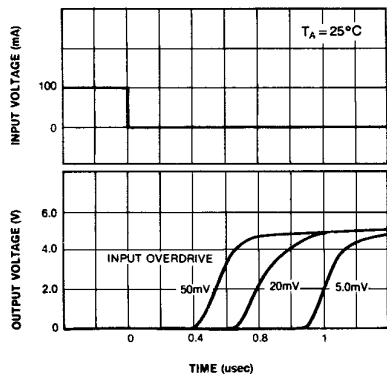

Figure 5. Response Time for Various Input Overdrive-Positive Transition

Mechanical Dimensions

Package

Dimensions in millimeters

14-DIP

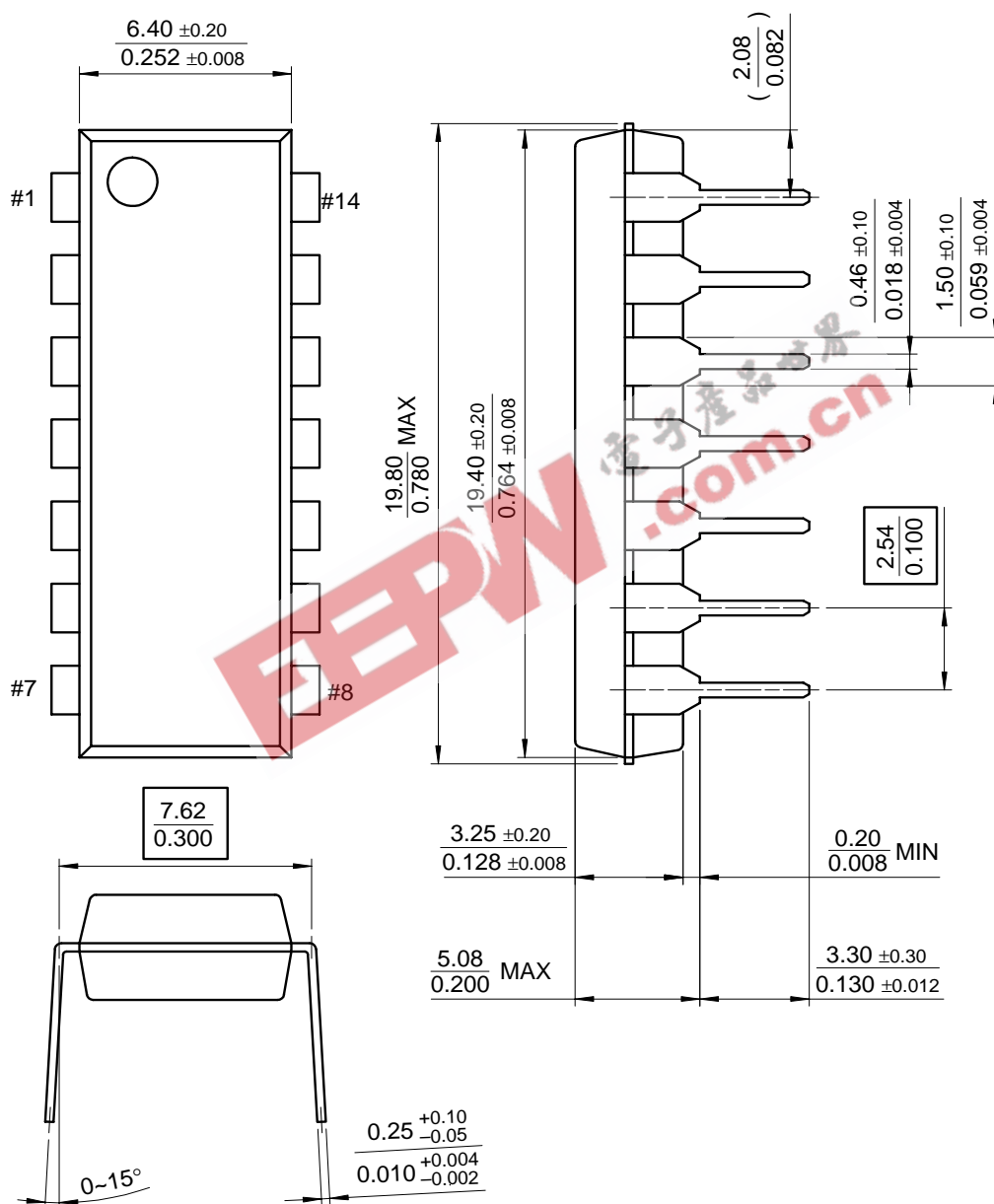

Mechanical Dimensions (Continued)

Package

Dimensions in millimeters

14-SOP

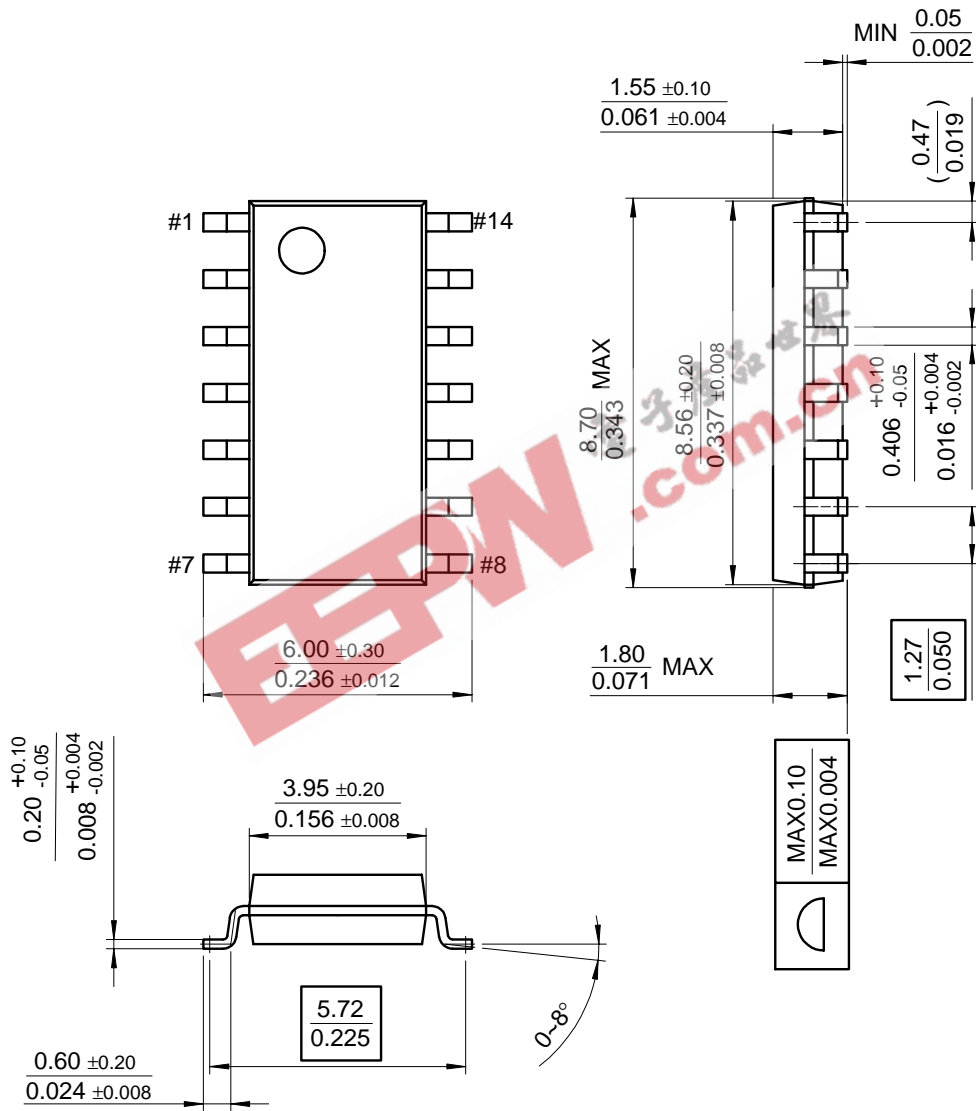

Ordering Information

Product Number	Package	Operating Temperature
KA339	14-DIP	0 ~ +70°C
KA339A		
KA339D	14-SOP	
KA339AD		
KA239	14-DIP	-25 ~ +85°C
KA239A		
KA239D	14-SOP	
KA239AD		
KA2901	14-DIP	-40 ~ +85°C
KA2901D	14-SOP	
KA3302	14-DIP	
KA3302D	14-SOP	



 EEPW.com.cn 电子產品世界

DISCLAIMER

FAIRCHILD SEMICONDUCTOR RESERVES THE RIGHT TO MAKE CHANGES WITHOUT FURTHER NOTICE TO ANY PRODUCTS HEREIN TO IMPROVE RELIABILITY, FUNCTION OR DESIGN. FAIRCHILD DOES NOT ASSUME ANY LIABILITY ARISING OUT OF THE APPLICATION OR USE OF ANY PRODUCT OR CIRCUIT DESCRIBED HEREIN; NEITHER DOES IT CONVEY ANY LICENSE UNDER ITS PATENT RIGHTS, NOR THE RIGHTS OF OTHERS.

LIFE SUPPORT POLICY

FAIRCHILD'S PRODUCTS ARE NOT AUTHORIZED FOR USE AS CRITICAL COMPONENTS IN LIFE SUPPORT DEVICES OR SYSTEMS WITHOUT THE EXPRESS WRITTEN APPROVAL OF THE PRESIDENT OF FAIRCHILD SEMICONDUCTOR CORPORATION. As used herein:

- Life support devices or systems are devices or systems which, (a) are intended for surgical implant into the body, or (b) support or sustain life, and (c) whose failure to perform when properly used in accordance with instructions for use provided in the labeling, can be reasonably expected to result in a significant injury of the user.
- A critical component in any component of a life support device or system whose failure to perform can be reasonably expected to cause the failure of the life support device or system, or to affect its safety or effectiveness.