Absolute Maximum Ratings

Parameter	Symbol	Value	Unit
Input Supply Voltage	V _{IN}	-0.3 ~ +30	V
Power Dissipation	P _D	Internally Limited	W
Thermal Resistance Junction-Air	R _{θJA}	127.5	°C/W
Storage Temperature Range	T _{STG}	-65 ~ +150	°C
Operating Junction Temperature Range	T _{OPR}	-40 ~ +125	°C

EEPW 电子產品世界
.com.cn

Electrical Characteristics

(Refer to the test circuit, $T_a = 25\text{ }^\circ\text{C}$, unless otherwise specified)

Parameter	Symbol	Conditions	Min.	Typ.	Max.	Unit
ALL VOLTAGE OPTIONS						
Output Voltage Temperature Coefficient	$\Delta V/\Delta T$	(Note1)	-	50	-	ppm/ $^\circ\text{C}$
Line Regulation (Note2)	ΔV	$(V_o + 1)V \leq V_{IN} \leq 28V$ $I_L = 50\text{mA}$	-	-	0.4	%
Load Regulation (Note2)	ΔV	$100\mu\text{A} \leq I_L \leq 100\text{mA}$	-	-	0.3	%
Dropout Voltage	V_D	$I_L = 100\mu\text{A}$	-	-	150	mV
		$I_L = 100\text{mA}$	-	-	600	mV
Ground Current	I_G	$I_L = 100\mu\text{A}$	-	-	140	μA
		$I_L = 100\text{mA}$	-	-	7	mA
Current Limit	I_{CL}	$V_O = 0V$	110	165	220	mA
8-PIN VERSIONS ONLY						
Reference Voltage	V_{REF}	(Note3)	1.235	1.26	1.285	V
	V_{REF}		1.225	1.26	1.295	V
ERROR COMPARATOR						
Output Low Voltage	V_{OL}	$V_{IN} = (V_o - 0.5)V, I_{OL} = 400\mu\text{A}$	-	150	400	mV
High Threshold Voltage	V_{TH}	(Note4)	25	60	-	mV
Low Threshold Voltage	V_{TL}	(Note4)	-	75	140	mV
Hysteresis	V_{HYS}	(Note4)	-	15	-	mV
SHUTDOWN INPUT						
Shutdown Threshold Range	V_{SD}	(Note5)	0.6	1.3	2.0	V
Shutdown Input Current	I_{SD}	$V_{SD} = 2.4V$	-	30	100	μA
		$V_{SD} = 28V$	-	450	750	μA

Note :

- Output or reference voltage temperature coefficient is defined as the worst case voltage change divided by the total temperature range.
- Regulation is measured at constant junction temperature , using pulse testing with a low duty cycle.
- $V_{ref} \leq V_{out} \leq (V_{in} - 1V)$, $2.5V \leq V_{in} \leq 28V$, $100\mu\text{A} \leq I_L \leq 100\text{mA}$, $T_A \leq T_{AMAX}$.
- Threshold and hysteresis are expressed in terms of voltage differential at the Feedback terminal below the normal reference . To express these thresholds in terms of output voltage change , multiply by the error amplifier gain = $V_O / V_{REF} = (R1 + R2) / R2$.
- $V_{shutdown} \leq 0.6V$, $V_{OUT} = ON$, $V_{shutdown} \geq 2.0V$, $V_{OUT} = OFF$.

Typical Performance Characteristics

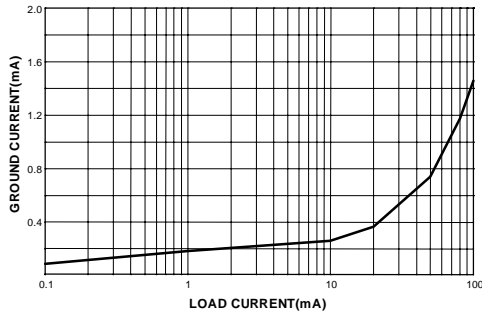

Figure 1. Quiescent Current

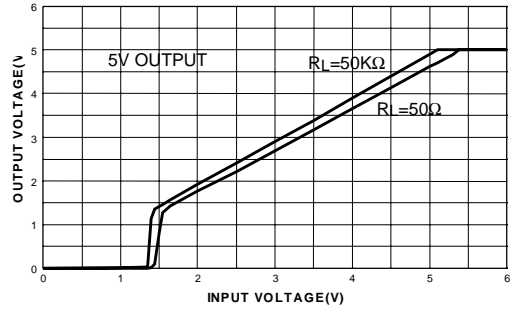

Figure 2. Dropout Characteristics

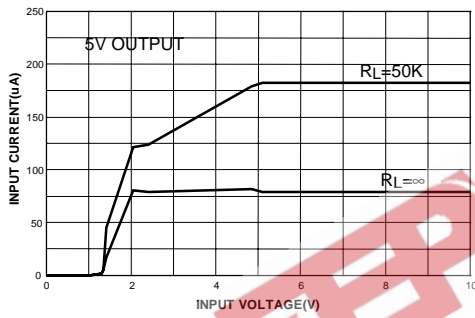

Figure 3. Input Current

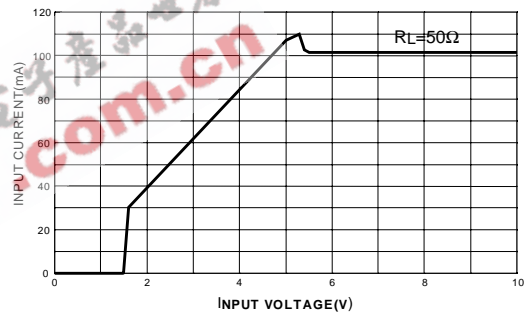

Figure 4. Input Current

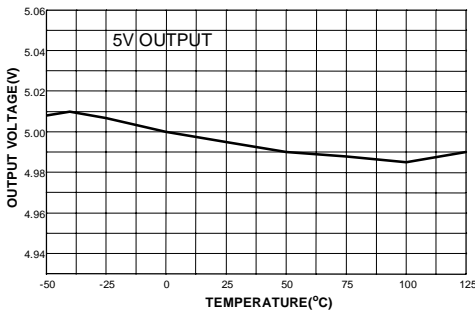

Figure 5. Output Voltage vs. Temperature

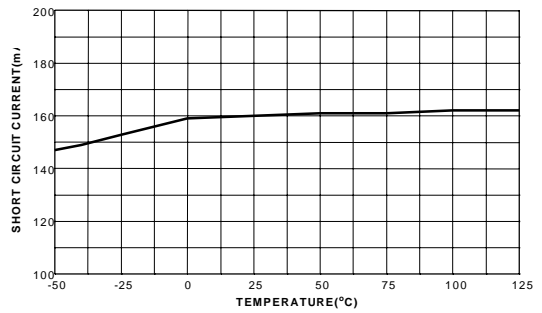

Figure 6. Short Circuit Current

Typical Performance Characteristics (Continued)

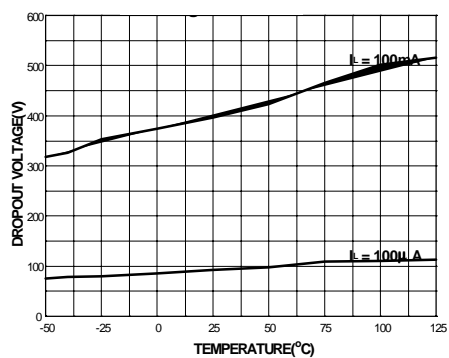

Figure 7. Dropout Voltage

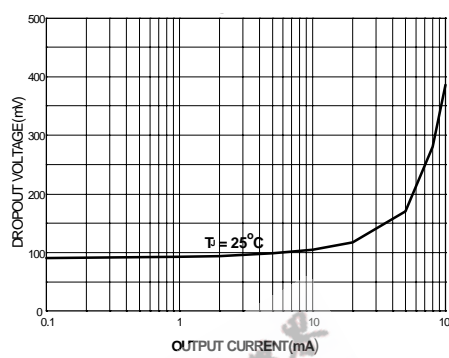
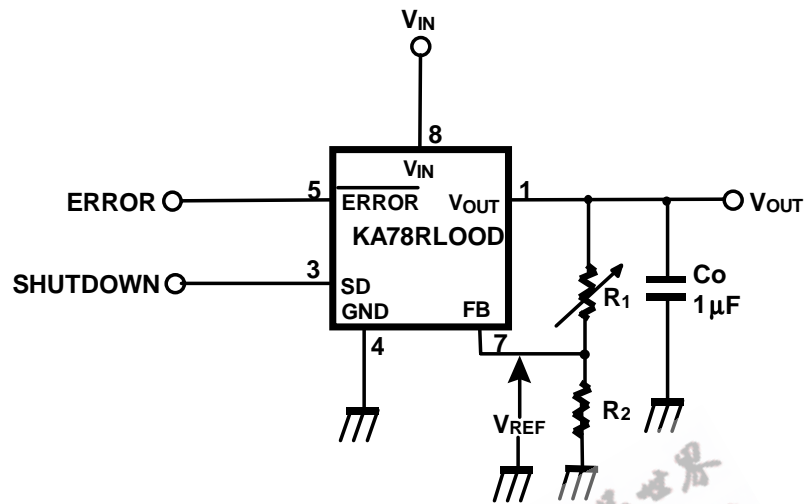

Figure 8. Dropout Voltage

EEPW.com.cn 电子工程世界

Typical Application



$$V_O = V_{REF} (1 + R_1/R_2) + I_{FB} R_1$$

CO is required between the output and ground for stability at output voltages of 5V or more. since IFB is controlled to less than 40nA, the error associated with this term is negligible in most applications.

At lower output voltage, more capacitance is required. without this capacitance the part will oscillate.

Mechanical Dimension

Package

Dimensions in millimeters

8-SOP

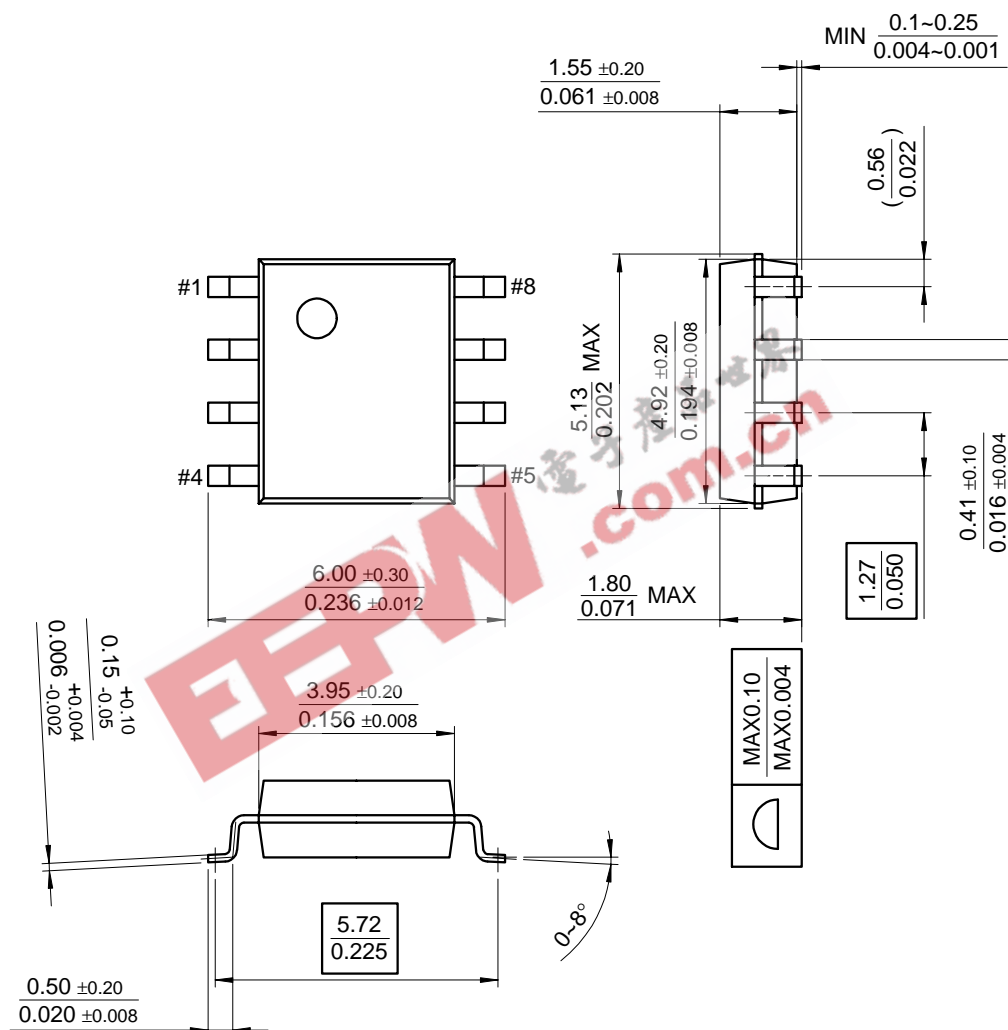

Ordering Information

Product Number	Package	Operating Temperature
KA78RL00D	8-SOP	-40 ~ +125°C

EEPW 电子產品世界
.com.cn

EEPW 电子产品世界
.com.cn



DISCLAIMER

FAIRCHILD SEMICONDUCTOR RESERVES THE RIGHT TO MAKE CHANGES WITHOUT FURTHER NOTICE TO ANY PRODUCTS HEREIN TO IMPROVE RELIABILITY, FUNCTION OR DESIGN. FAIRCHILD DOES NOT ASSUME ANY LIABILITY ARISING OUT OF THE APPLICATION OR USE OF ANY PRODUCT OR CIRCUIT DESCRIBED HEREIN; NEITHER DOES IT CONVEY ANY LICENSE UNDER ITS PATENT RIGHTS, NOR THE RIGHTS OF OTHERS.

LIFE SUPPORT POLICY

FAIRCHILD'S PRODUCTS ARE NOT AUTHORIZED FOR USE AS CRITICAL COMPONENTS IN LIFE SUPPORT DEVICES OR SYSTEMS WITHOUT THE EXPRESS WRITTEN APPROVAL OF THE PRESIDENT OF FAIRCHILD SEMICONDUCTOR CORPORATION. As used herein:

1. Life support devices or systems are devices or systems which, (a) are intended for surgical implant into the body, or (b) support or sustain life, and (c) whose failure to perform when properly used in accordance with instructions for use provided in the labeling, can be reasonably expected to result in a significant injury of the user.
2. A critical component in any component of a life support device or system whose failure to perform can be reasonably expected to cause the failure of the life support device or system, or to affect its safety or effectiveness.