

2.0A SINGLE-PHASE BRIDGE RECTIFIER

Features

- Diffused Junction
- Low Forward Voltage Drop
- High Current Capability
- High Reliability
- High Surge Current Capability
- Ideal for Printed Circuit Boards
-  Recognized File # E157705

Mechanical Data

- Case: KBP, Molded Plastic
- Terminals: Plated Leads Solderable per MIL-STD-202, Method 208
- Polarity: As Marked on Body
- Weight: 1.7 grams (approx.)
- Mounting Position: Any
- Marking: Type Number
- **Lead Free: For RoHS / Lead Free Version, Add "-LF" Suffix to Part Number, See Page 4**

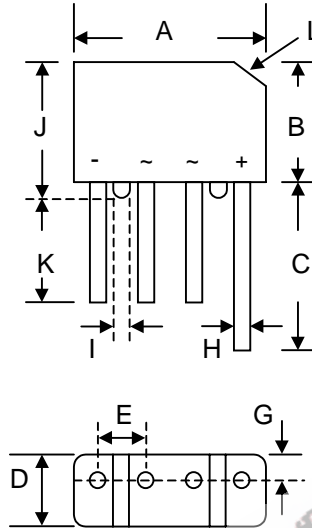

KBP		
Dim	Min	Max
A	14.22	15.24
B	10.67	11.68
C	15.20	—
D	4.57	5.08
E	3.60	4.10
G	1.00	1.40
H	0.76	0.86
I	1.52	—
J	11.68	12.70
K	12.7	—
L	3.2 x 45° Typical	
All Dimensions in mm		

Maximum Ratings and Electrical Characteristics @T_A=25°C unless otherwise specified

Single Phase, half wave, 60Hz, resistive or inductive load.
For capacitive load, derate current by 20%.

Characteristic	Symbol	KBP 200	KBP 201	KBP 202	KBP 204	KBP 206	KBP 208	KBP 2010	Unit
Peak Repetitive Reverse Voltage Working Peak Reverse Voltage DC Blocking Voltage	V _{RRM} V _{RWM} V _R	50	100	200	400	600	800	1000	V
RMS Reverse Voltage	V _{R(RMS)}	35	70	140	280	420	560	700	V
Average Rectified Output Current @T _A = 55°C	I _O	2.0							A
Non-Repetitive Peak Forward Surge Current 8.3ms Single half sine-wave superimposed on rated load (JEDEC Method)	I _{FSM}	60							A
Forward Voltage per leg @I _F = 2.0A	V _{FM}	1.1							V
Peak Reverse Current @T _A = 25°C At Rated DC Blocking Voltage @T _A = 125°C	I _{RM}	5.0 500							μA
Rating for Fusing (t<8.3ms)	I ² t	15							A ² s
Typical Junction Capacitance per leg (Note 1)	C _j	25							pF
Typical Thermal Resistance per leg (Note 2)	R _{θJA} R _{θJL}	30 11							°C/W
Operating and Storage Temperature Range	T _j , T _{STG}	-55 to +165							°C

Note: 1. Measured at 1.0 MHz and applied reverse voltage of 4.0V D.C.
2. Mounted on PC board with 12mm² copper pad.

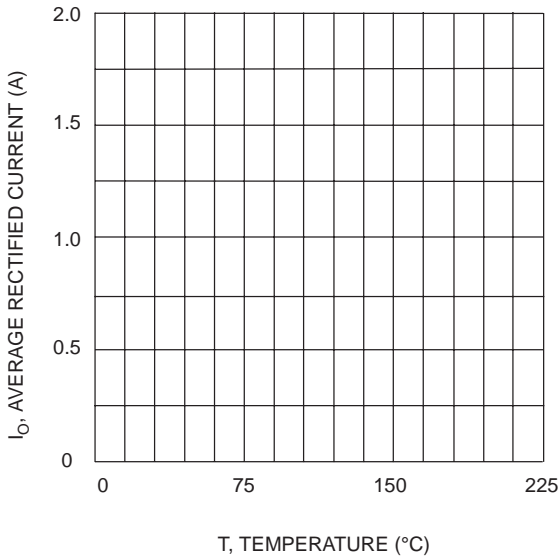

Fig. 1 Forward Current Derating Curve

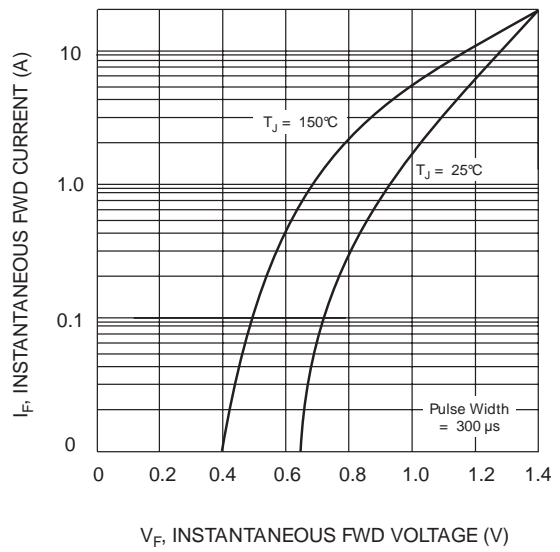

Fig. 2 Typical Fwd Characteristics

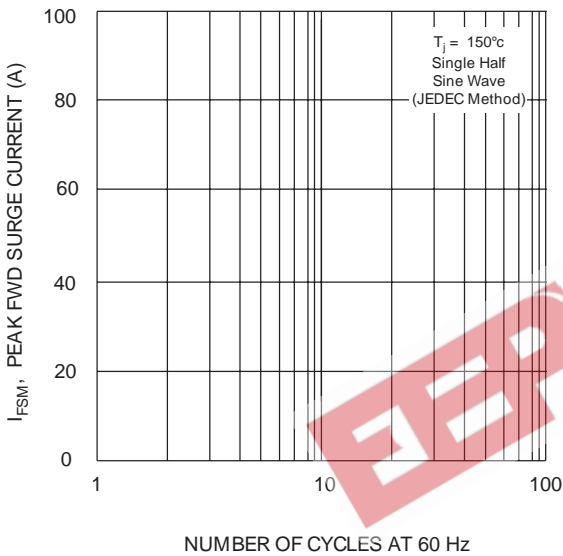

Fig. 3 Max Non-Repetitive Peak Fwd Surge Current

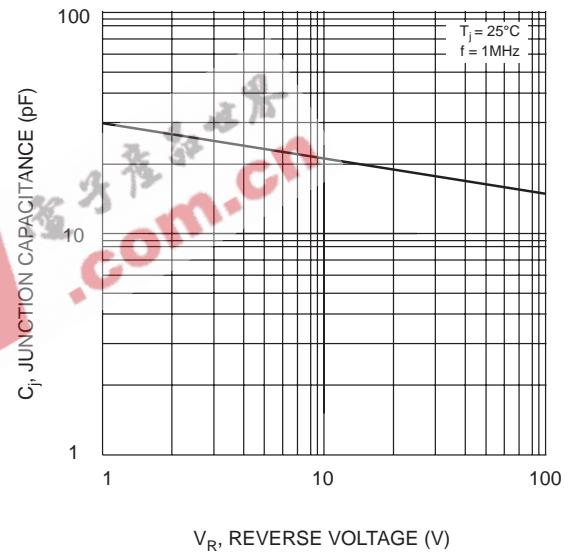

Fig. 4 Typical Junction Capacitance

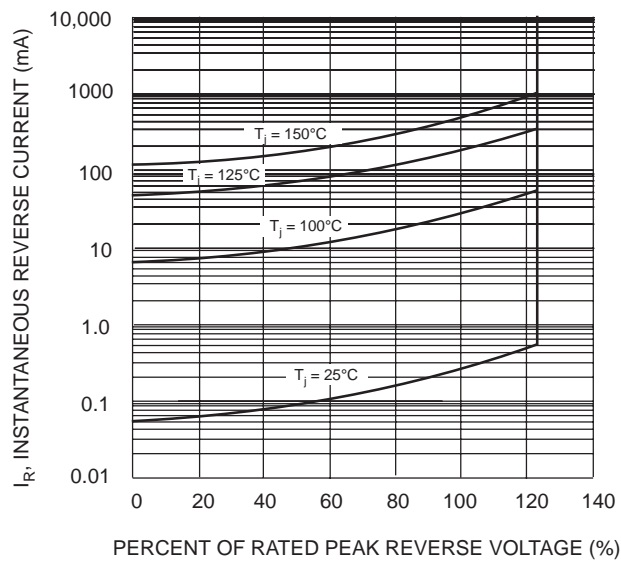
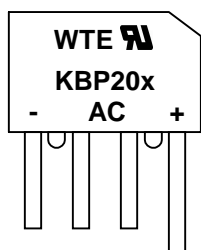

Fig. 5 Typical Reverse Characteristics

MARKING INFORMATION



WTE = Manufacturer's Logo
 KBP20x = Device Number
 x = 0, 1, 2, 4, 6, 8 or 10
 Polarity = As Marked on Body

PACKAGING INFORMATION

BULK

Inner Box Size L x W x H (mm)	Quantity (PCS)	Carton Size L x W x H (mm)	Quantity (PCS)	Approx. Gross Weight (KG)
200 x 160 x 42	600	425 x 215 x 280	7,200	17.0

Note: 1. Paper box, white or brown color.

EEPW.com.cn

ORDERING INFORMATION

Product No.	Package Type	Shipping Quantity
KBP200	SIL Bridge	600 Units/Box
KBP201	SIL Bridge	600 Units/Box
KBP202	SIL Bridge	600 Units/Box
KBP204	SIL Bridge	600 Units/Box
KBP206	SIL Bridge	600 Units/Box
KBP208	SIL Bridge	600 Units/Box
KBP2010	SIL Bridge	600 Units/Box

1. Shipping quantity given is for minimum packing quantity only. For minimum order quantity, please consult the Sales Department.
2. **To order Lead Free version (with Lead Free finish), add "-LF" suffix to part number above. For example, KBP200-LF.**

EEPW 电子產品世界
.com.cn

Won-Top Electronics Co., Ltd (WTE) has checked all information carefully and believes it to be correct and accurate. However, WTE cannot assume any responsibility for inaccuracies. Furthermore, this information does not give the purchaser of semiconductor devices any license under patent rights to manufacturer. WTE reserves the right to change any or all information herein without further notice.

WARNING: DO NOT USE IN LIFE SUPPORT EQUIPMENT. WTE power semiconductor products are not authorized for use as critical components in life support devices or systems without the express written approval.

Won-Top Electronics Co., Ltd.

No. 44 Yu Kang North 3rd Road, Chine Chen Dist., Kaohsiung, Taiwan

Phone: 886-7-822-5408 or 886-7-822-5410

Fax: 886-7-822-5417

Email: sales@wontop.com

Internet: <http://www.wontop.com>

We power your everyday.