

SANYO

No.2663A

LC7936A, 7936B**32-Bit PPC LED Erasing Head Driver****Features**

- High-speed, high-voltage silicon gate CMOS device
- Contains high-speed shiftable (5MHz max) 32-bit shift register, 32-bit latch, output driver on/off control circuit, 32-bit N-channel open drain output driver.
- Serial shift data is shifted on the positive transition of the clock signal (CLOCK).
- 32-bit latch data is changed on the negative transition of the LATCH pad signal and is held on the positive transition.
- The STROBE pad signal, BEO pad signal can be used to exercise on/off control of the output driver.
- All output drivers can be turned on by setting 32-bit latch regardless of shift register data. (TEST=Hi, STROBE=Lo, BEO=Hi)
- Complete separation of logic circuit GND (1 pad) and thermal driver GND (4 pads)
- Maximum ratings of driver output: $V_O=15V$, $I_{OL}=30mA$
- Logic unit operating voltage: $V_{DD}=4.5V$ to $5.5V$

Absolute Maximum Ratings at $T_a=25^\circ C$

			unit
Maximum Supply Voltage	V_{DD}	-0.3 to +7.0	V
Input Voltage	V_I	-0.3 to $V_{DD}+0.3$	V
Output Voltage	V_O (1)	S_{OUT} output	-0.3 to $V_{DD}+0.3$ V
	V_O (2)	D1 to D32 output	15 V
Output Circuit	I_O	Output Tr off	
		D1 to D32 output, per output	30 mA
Allowable Power Dissipation	P_d max	QIP-64 package at $70^\circ C$	450 mW
Operating Temperature	T_{opr}	QIP-64 package	0 to +70 $^\circ C$
Storage Temperature	T_{stg}	QIP-64 package	-35 to +125 $^\circ C$

Package Dimensions 3057-Q64AIC

(unit: mm)

LC7936A

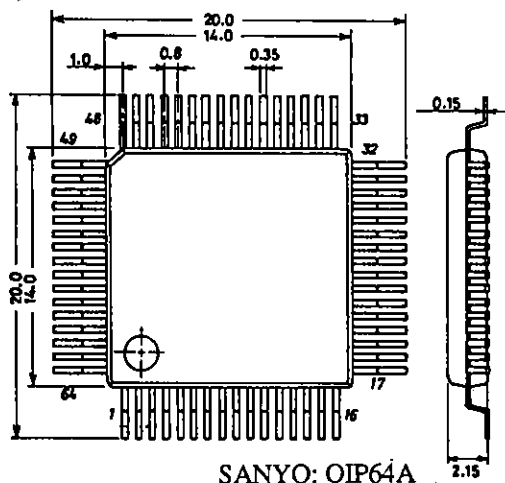
**Package Dimensions 3026B-Q64BIC**

(unit: mm)

LC7936B

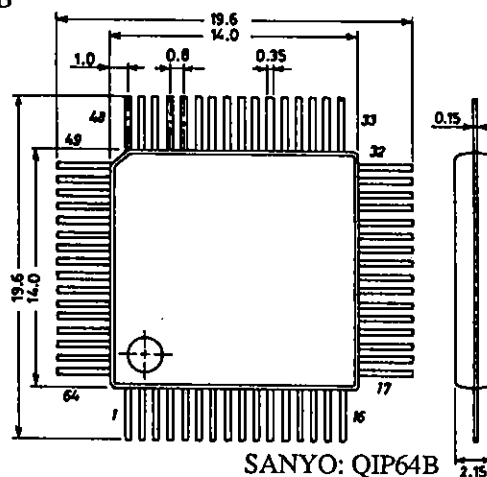

Allowable Operating Conditions at Ta=0 to +70°C

		Pin Name	min	typ	max	unit
Supply Voltage	V _{DD}	V _{DD}	4.5		5.5	V
"H"-Level Input Voltage	V _{IH}	S _{IN} , CLOCK, $\overline{\text{LATCH}}$ BEO, $\overline{\text{STROBE}}$, LED-check (TEST)	0.8V _{DD}		V _{DD}	V
"L"-Level Input Voltage	V _{IL}	S _{IN} , CLOCK, $\overline{\text{LATCH}}$, BEO, $\overline{\text{STROBE}}$, LED-check (TEST)	V _{SS} (L)		0.2V _{DD}	V
Clock Frequency	f _{CLK}	CLOCK Duty: 50%			5.0	MHz
Clock Pulse Width	t _w	CLOCK	75			ns
Clock Rise/Fall Time	t _r , t _f	CLOCK			200	ns
Data Setup Time	t _{DS}	S _{IN} , CLOCK	100			ns
Data Hold Time	t _{DH}	S _{IN} , CLOCK	50			ns
Latch Pulse Width	t _{wL}	$\overline{\text{LATCH}}$	100			ns

Electrical Characteristics at Ta=25°C

		Pin Name	min	typ	max	unit
"H"-Level Input Current	I _{IH} (1)	S _{IN} , CLOCK $\overline{\text{LATCH}}$			10	μA
"H"-Level Input Current	I _{IH} (2)	BEO, LED-check (TEST)	12		72	μA
"L"-Level Input Current	I _{IL} (1)	S _{IN} , CLOCK $\overline{\text{LATCH}}$	-10			μA
"L"-Level Input Current	I _{IL} (2)	$\overline{\text{STROBE}}$	-72		-12	μA
"H"-Level Output Voltage	V _{OH}	S _{OUT}	V _{DD} =5V, I _{OH} =-0.5mA	V _{DD} -0.5		V
"L"-Level Output Voltage	V _{OL} (1)	S _{OUT}	V _{DD} =5V, I _{OL} =0.5mA		0.5	V
"L"-Level Output Voltage	V _{OL} (2)	D1 to D32	V _{DD} =5V, I _{OL} =30 mA		0.5	V
Output Off-State Leakage Current	I _{OFF}	D1 to D32	V _O =15V		20	μA
Input Capacitance	C _{IN}	CLOCK		5.0		pF
Operating Current Dissipation	I _{DD}	V _{DD}	V _{DD} =5V, f _{CLK} =5MHz, all outputs: no load		5	mA

Switching Characteristics at Ta=25°C

		Pin Name	min	typ	max	unit
Clock Latch Delay Width	t _{CL}	CLOCK, $\overline{\text{LATCH}}$	V _{DD} =5V	100		ns
Latch Clock Delay Width	t _{LC}	CLOCK, $\overline{\text{LATCH}}$	V _{DD} =5V	0		ns
"H"-Level Output Propagation Delay Time	t _{PLH} (1)	$\overline{\text{LATCH}}$, D1 to D32	V _{DD} =5V, Dn: R _L =1.0kΩ CL=15pF		400	ns
	t _{PLH} (2)	BEO, $\overline{\text{STROBE}}$	V _{DD} =5V, Dn: R _L =1.0kΩ CL=15pF		300	ns
	t _{PLH} (3)	CLOCK, S _{OUT}	V _{DD} =5V, S _{OUT} : C _L =15pF		200	ns
"L"-Level Output Propagation Delay Time	t _{PHL} (1)	$\overline{\text{LATCH}}$, D1 to D32	V _{DD} =5V, Dn: R _L =1.0kΩ C _L =15pF		200	ns
	t _{PHL} (2)	BEO, $\overline{\text{STROBE}}$ D1 to D32	V _{DD} =5V, Dn: R _L =1.0kΩ C _L =15pF		100	ns
	t _{PHL} (3)	CLOCK, S _{OUT}	V _{DD} =5V, S _{OUT} : C _L =15pF		200	ns

LED Driver On/Off Truth Table

Latch Data (Q)	BEO	$\overline{\text{STROBE}}$	LED Driver
0	0	0	OFF
1	0	0	OFF
0	1	0	OFF
1	1	0	ON LED on
0	0	1	OFF
1	0	1	OFF
0	1	1	OFF
1	1	1	OFF

Equivalent Circuit Block Diagram

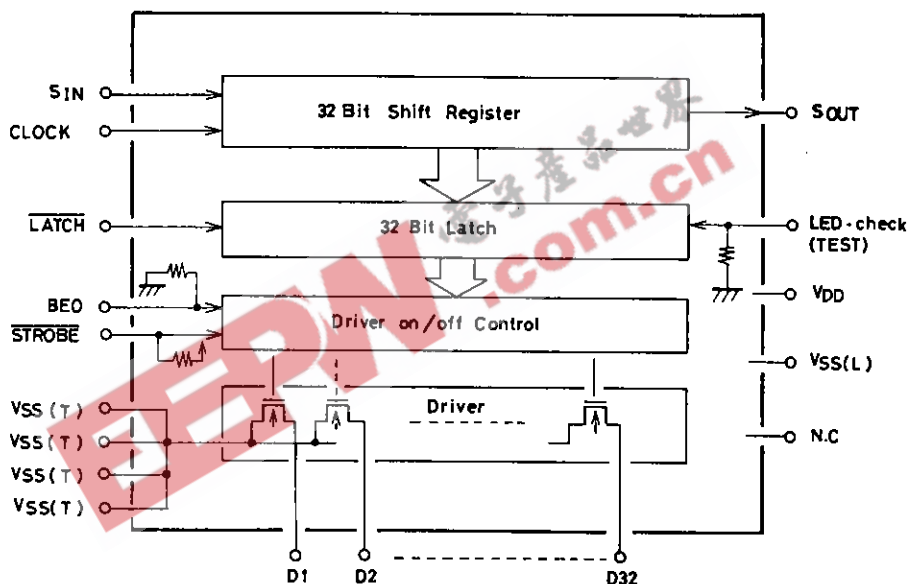

Output Driver Section Equivalent Circuit

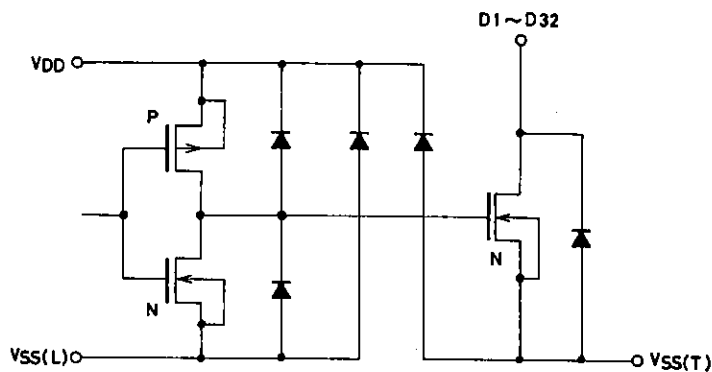

LC7936A,7936B

Pin Assignment

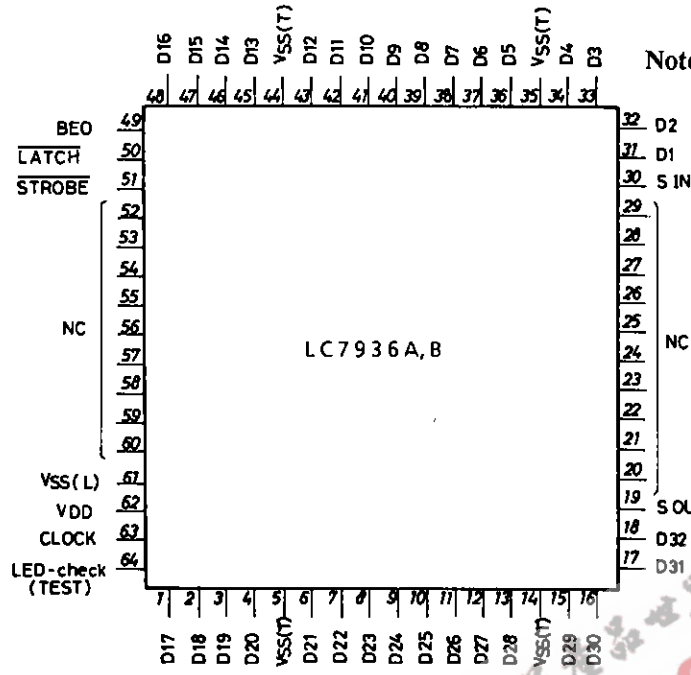

Note: Pins 24, 25 of NC pins are connected to the substrate ($=V_{DD}$) and must be kept open. Other NC pins must be also kept open. When the LED-check (TEST) pin is not in use, it must not be kept open, but must be connected to GND.

Input Data Timing Chart

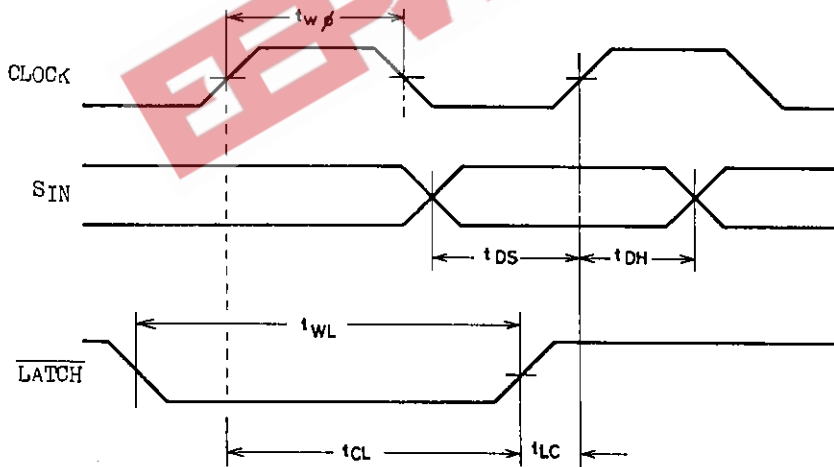

Output Data Timing Chart

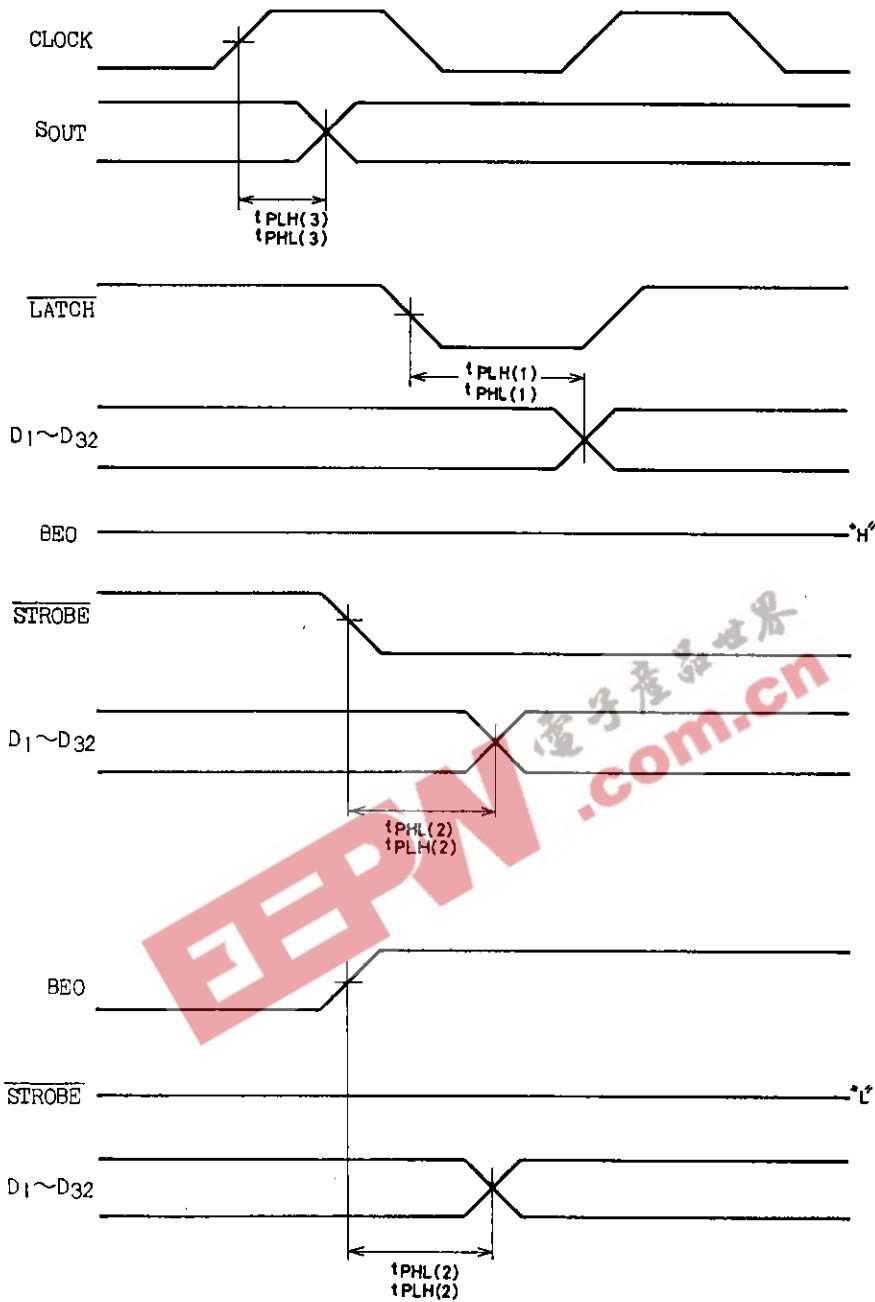

■ No products described or contained herein are intended for use in surgical implants, life-support systems, aerospace equipment, nuclear power control systems, vehicles, disaster/crime-prevention equipment and the like, the failure of which may directly or indirectly cause injury, death or property loss.

■ Anyone purchasing any products described or contained herein for an above-mentioned use shall:

- ① Accept full responsibility and indemnify and defend SANYO ELECTRIC CO., LTD., its affiliates, subsidiaries and distributors and all their officers and employees, jointly and severally, against any and all claims and litigation and all damages, cost and expenses associated with such use;
- ② Not impose any responsibility for any fault or negligence which may be cited in any such claim or litigation on SANYO ELECTRIC CO., LTD., its affiliates, subsidiaries and distributors or any of their officers and employees jointly or severally.

■ Information (including circuit diagrams and circuit parameters) herein is for example only; it is not guaranteed for volume production. SANYO believes information herein is accurate and reliable, but no guarantees are made or implied regarding its use or any infringements of intellectual property rights or other rights of third parties.