

# LM1458/LM1458C

## Dual Operational Amplifier

### Features

- Internal frequency compensation
- Short circuit protection
- Large common mode and differential voltage range
- No latch up
- Low power consumption

### Description

The LM1458/LM1458C series are dual general purpose operational amplifiers, having short circuits protected and require no external components for frequency compensation. High common mode voltage range and absence of "latch up" make the LM1458 ideal for use as voltage followers. The high gain and wide range of operating voltage provides superior performance in integrator, summing amplifier and general feedback applications.



### Internal Block Diagram

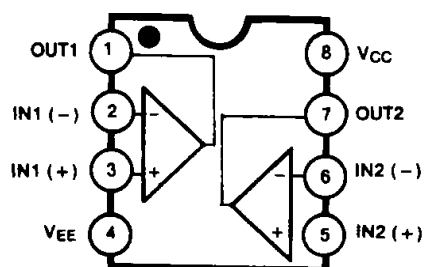

## Schematic Diagram

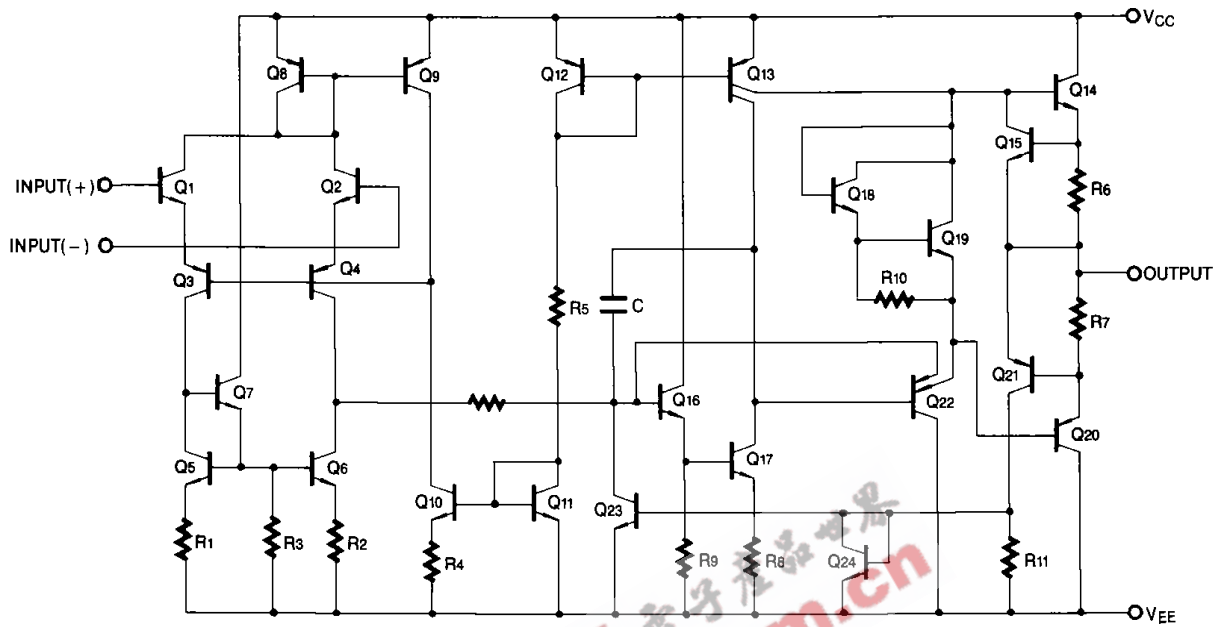

## Absolute Maximum Ratings

Parameter	Symbol	Value	Unit
Power Supply Voltage	V <sub>CC</sub>	±18	V
Input Differential Voltage	V <sub>I(DIFF)</sub>	30	V
Input Voltage	V <sub>I</sub>	±15	V
Operating Temperature Range	T <sub>OPR</sub>	0 ~ + 70	°C
Storage Temperature Range	T <sub>STG</sub>	- 65 ~ + 150	°C

## Electrical Characteristics

( $V_{CC} = +15V$ ,  $V_{EE} = -15V$ ,  $T_A = 25\text{ }^\circ\text{C}$  unless otherwise specified)

Parameter	Symbol	Conditions	LM1458C			LM1458			Unit
			Min.	Typ.	Max.	Min.	Typ.	Max.	
Input Offset Voltage	$V_{IO}$	$R_S \leq 10K\Omega$	-	2.0	10	-	2.0	6.0	mV
Input Offset Current	$I_{IO}$	-	-	20	300	-	20	200	nA
Input Bias Current	$I_{BIAS}$	-	-	80	700	-	80	500	nA
Large Signal Voltage Gain	$G_V$	$V_{O(P-P)} = \pm 10V$ , $R_L \geq 2.0K\Omega$	20	200	-	20	200	-	V/mV
Input Voltage Range	$V_{I(R)}$	-	$\pm 11$	$\pm 13$	-	$\pm 12$	$\pm 13$	-	V
Input Resistance	$R_I$	-	0.3	1.0	-	0.3	1.0	-	$M\Omega$
Common Mode Rejection Ratio	CMRR	-	60	90	-	70	90	-	dB
Power Supply Rejection Ratio	PSRR	-	77	90	-	77	90	-	dB
Supply Current (Both Amplifier)	$I_{CC}$	-	-	2.3	8.0	-	2.3	-	mA
Output Voltage Swing	$V_{O(PP)}$	$R_S \leq 10K\Omega$	$\pm 11$	$\pm 14$	-	$\pm 12$	$\pm 14$	5.6	V
		$R_S \leq 10K\Omega$	$\pm 19$	$\pm 13$	-	$\pm 10$	$\pm 13$	-	
Output Short Circuit Current	$I_{SC}$	-	-	20	-	-	20	-	mA
Power Consumption	$P_C$	$V_O = 0V$	-	70	240	-	70	170	mW
Transient Response (Unity Gain)									
Rise Time	$T_R$	$V_I = 20mV$ , $R_L \geq 2K\Omega$ , $C_L \leq 100pF$	-	0.3	-	-	0.3	-	$\mu s$
Overshoot	OS	$V_I = 20mV$ , $R_L \geq 2K\Omega$ , $C_L \leq 100pF$		15			15		%
Slew Rate	SR	$V_I = 10V$ , $R_L \geq 2K\Omega$ , $C_L \leq 100pF$		0.5			0.5		V/ $\mu s$

## Electrical Characteristics

( $V_{CC} = +15V$ ,  $V_{EE} = -15V$ , Note1, unless otherwise specified)

Parameter	Symbol	Conditions	LM1458C			LM1458			Unit
			Min.	Typ.	Max.	Min.	Typ.	Max.	
Input Offset Voltage	$V_{IO}$	$R_S \leq 10K\Omega$	-	-	12	-	-	7.5	mV
Input Offset Current	$I_{IO}$	-	-	-	400	-	-	300	nA
Input Bias Current	$I_{BIAS}$	-	-	-	1000	-	-	800	nA
Large Signal Voltage Gain	$G_V$	$V_{O(P-P)} = \pm 10V$ , $R_L \leq 2.0K\Omega$	15	-	-	15	-	-	V/mV
Common Mode Rejection Ratio	CMRR	$R_S \geq 10K\Omega$	70	90	-	70	90	-	dB
Power Supply Rejection Ratio	PSRR	$R_S \geq 10K\Omega$	77	90	-	77	90	-	dB
Output Voltage Swing	$V_{O(P.P)}$	$R_L = 10K\Omega$	$\pm 11$	$\pm 14$	-	$\pm 12$	$\pm 14$	-	V
		$R_L = 2K\Omega$	$\pm 9$	$\pm 13$	-	$\pm 10$	$\pm 13$	-	
Input Voltage Range	$V_{I(R)}$	-	$\pm 12$	-	-	$\pm 12$	-	-	V

### Note :

1. LM1458/LM1458C :  $0^\circ C \leq T_A \leq 70^\circ C$

## Typical Performance Characteristics

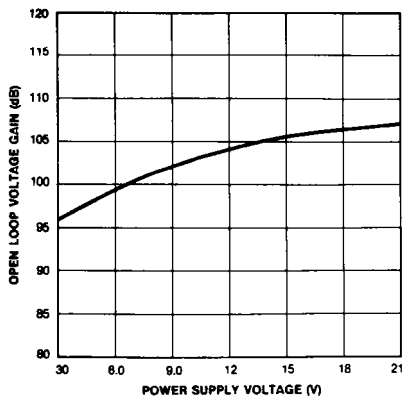

Figure 1. Open-Loop Voltage Gain vs Power Supply Voltages

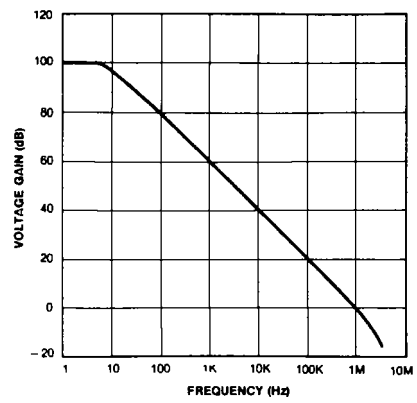

Figure 2. Open-Loop Frequency Response

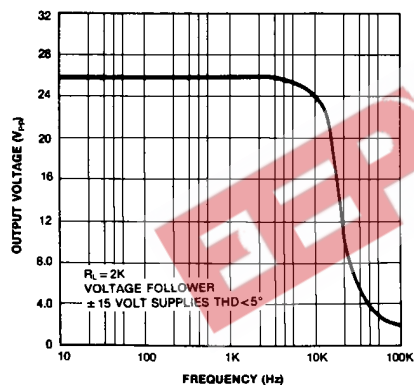

Figure 3. Power Bandwidth (Large Signal Output Swing vs Frequency)

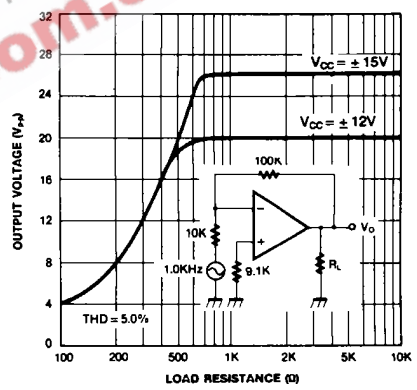
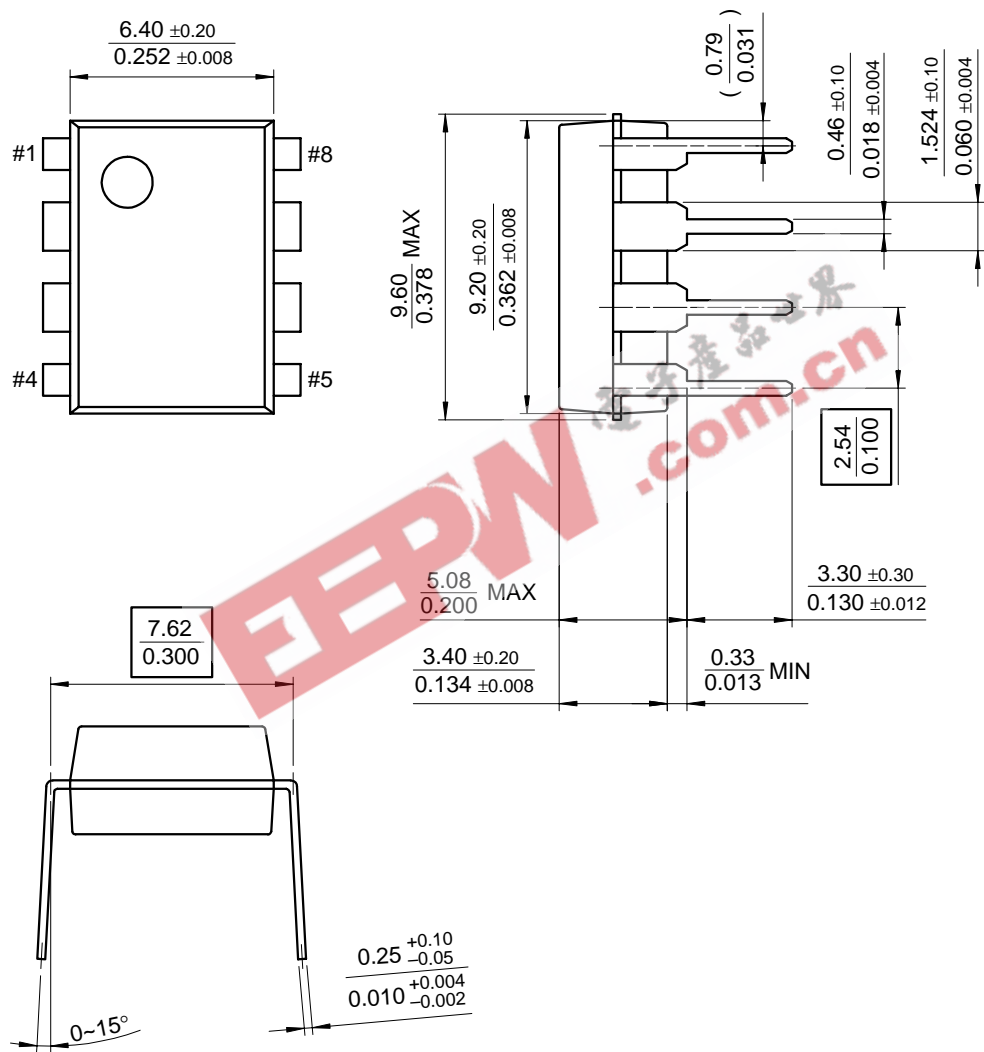

Figure 4. Output Voltage Swing vs Load Resistance

## Mechanical Dimensions

### Package

### 8-DIP



## Mechanical Dimensions (Continued)

### Package

## 8-SOP

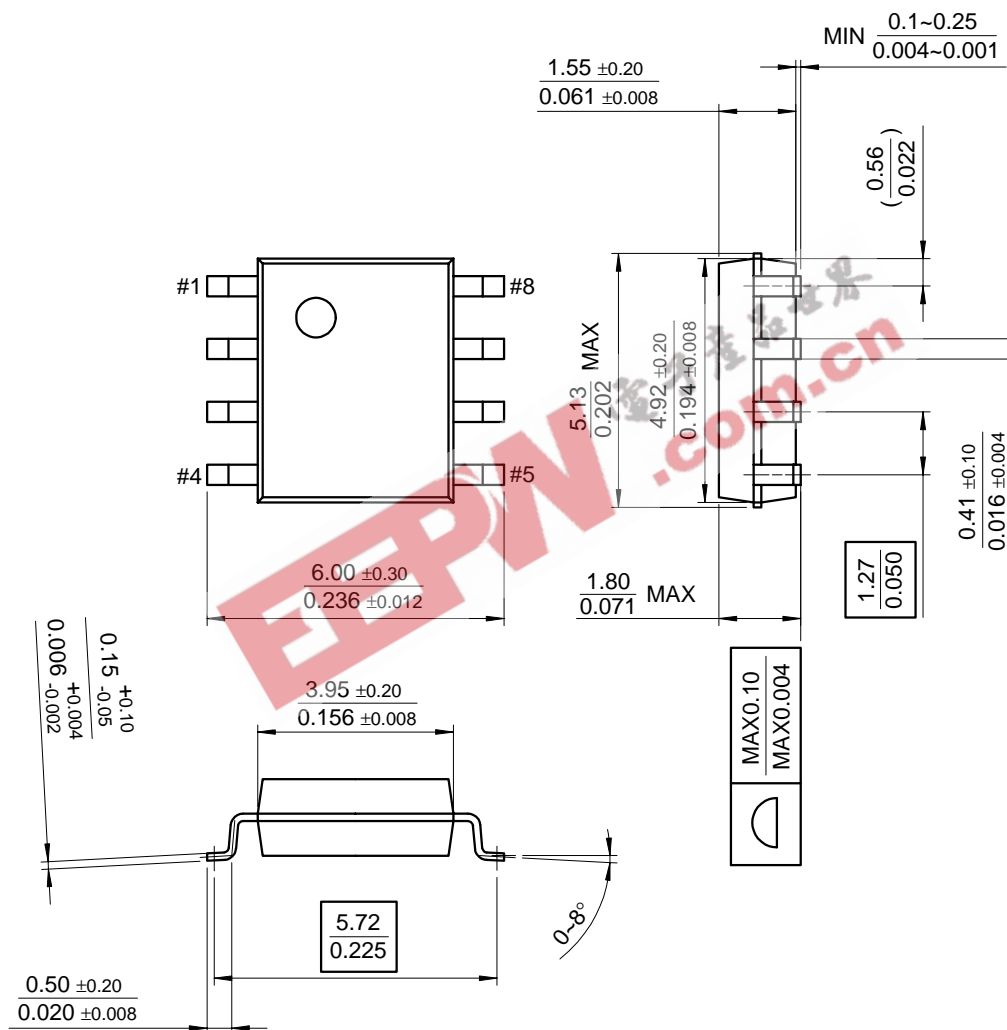

## Ordering Information

Product Number	Package	Operating Temperature
LM1458CN	8-DIP	0 ~ + 70°C
LM1458N		
LM1458CM	8-SOP	
LM1458M		

EEPW 电子产品世界  
.com.cn



EEPW 电子产品世界  
.com.cn



**DISCLAIMER**

FAIRCHILD SEMICONDUCTOR RESERVES THE RIGHT TO MAKE CHANGES WITHOUT FURTHER NOTICE TO ANY PRODUCTS HEREIN TO IMPROVE RELIABILITY, FUNCTION OR DESIGN. FAIRCHILD DOES NOT ASSUME ANY LIABILITY ARISING OUT OF THE APPLICATION OR USE OF ANY PRODUCT OR CIRCUIT DESCRIBED HEREIN; NEITHER DOES IT CONVEY ANY LICENSE UNDER ITS PATENT RIGHTS, NOR THE RIGHTS OF OTHERS.

**LIFE SUPPORT POLICY**

FAIRCHILD'S PRODUCTS ARE NOT AUTHORIZED FOR USE AS CRITICAL COMPONENTS IN LIFE SUPPORT DEVICES OR SYSTEMS WITHOUT THE EXPRESS WRITTEN APPROVAL OF THE PRESIDENT OF FAIRCHILD SEMICONDUCTOR CORPORATION. As used herein:

1. Life support devices or systems are devices or systems which, (a) are intended for surgical implant into the body, or (b) support or sustain life, and (c) whose failure to perform when properly used in accordance with instructions for use provided in the labeling, can be reasonably expected to result in a significant injury of the user.
2. A critical component in any component of a life support device or system whose failure to perform can be reasonably expected to cause the failure of the life support device or system, or to affect its safety or effectiveness.