



# LC7851E

## QPSK Demodulation and Audio Signal-Processing IC for Satellite Broadcast Reception

### Overview

The LC7851E demodulates the QPSK (quadrature phase shift keying) modulated audio data broadcast by the Japanese BS and CS broadcast satellites and converts that data to an analog audio signal. This IC integrates on a single chip the audio system signal processing required for BS and CS receivers from QPSK demodulation to analog audio reproduction. The main functions provided by the LC7851E include QPSK demodulation, differential decoding conversion, descrambling, deinterleaving, and error correction. It also generates a PCM audio signal. The PCM audio signal is converted to an analog audio signal by on-chip digital filters and A/D converters.

### Features

- QPSK demodulator, PCM decoder, digital filters, D/A converters, and operational amplifiers integrated on a single chip.
- The number of required external components has been reduced and adjustment-free operation achieved in the QPSK demodulator by implementing that block as a digital circuit on a single chip.
- CPU interface using an I<sup>2</sup>C bus
- Interface circuits for CORTEC and SkyPort descramblers
- Ten to 14 bit expansion of audio data during A mode broadcasts.
- Data protection using majority control for the upper bits of the audio data during B mode broadcasts
- Full complement of muting functions
  - Audio suppression provided (bit 16 of the post-majority decision control bits)
  - Non-audio signal suppression (bits 2 to 5 of the post-majority decision control bits)
  - Forced muting
  - Muting when not synchronized
  - Muting when large numbers of errors are detected (modifiable conditions)
  - Channel switching
  - Charged (pay-per-view) program flag muting
  - Mute detection output provided.
- General-purpose ports (2 input ports and 8 output ports)
- EIAJ digital audio interface output
- 8× oversampling digital filters
- Multi-bit D/A converter (with built-in output operational amplifiers)
- 5 V single-voltage power supply
- QFP (QIP) 64E package

### Functions

- QPSK demodulation
- Bit timing clock recovery
- Differential decoding conversion and parallel-to-serial conversion
- Frame synchronization (forward protection: 8 cycles, back protection: 3 cycles): Frame synchronized/not synchronized detection flag output provided.
- Tenth-order M-series descrambling
- Deinterleaving
- BCH (63, 56) error correction and dual error detection: Single error detected flag output provided.
- Support for both interpolation and previous data hold when a dual error is detected.  
Control bit majority judgment protection every 16 frames
- Register data previous value hold when dual errors are detected using BCH(7,3)

### Package Dimensions

unit: mm

#### 3195-QFP64E

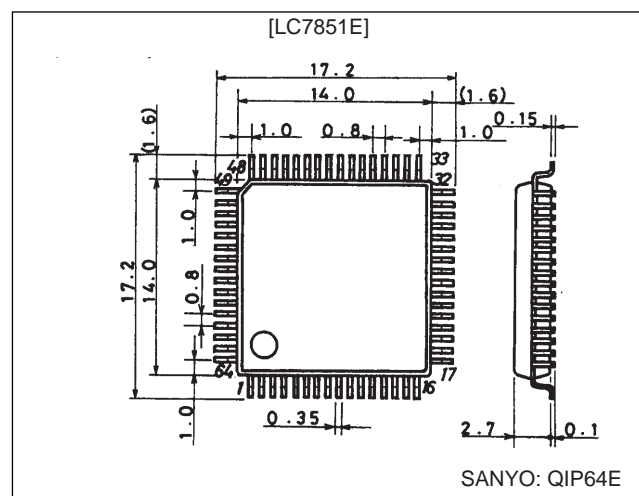

Block Diagram

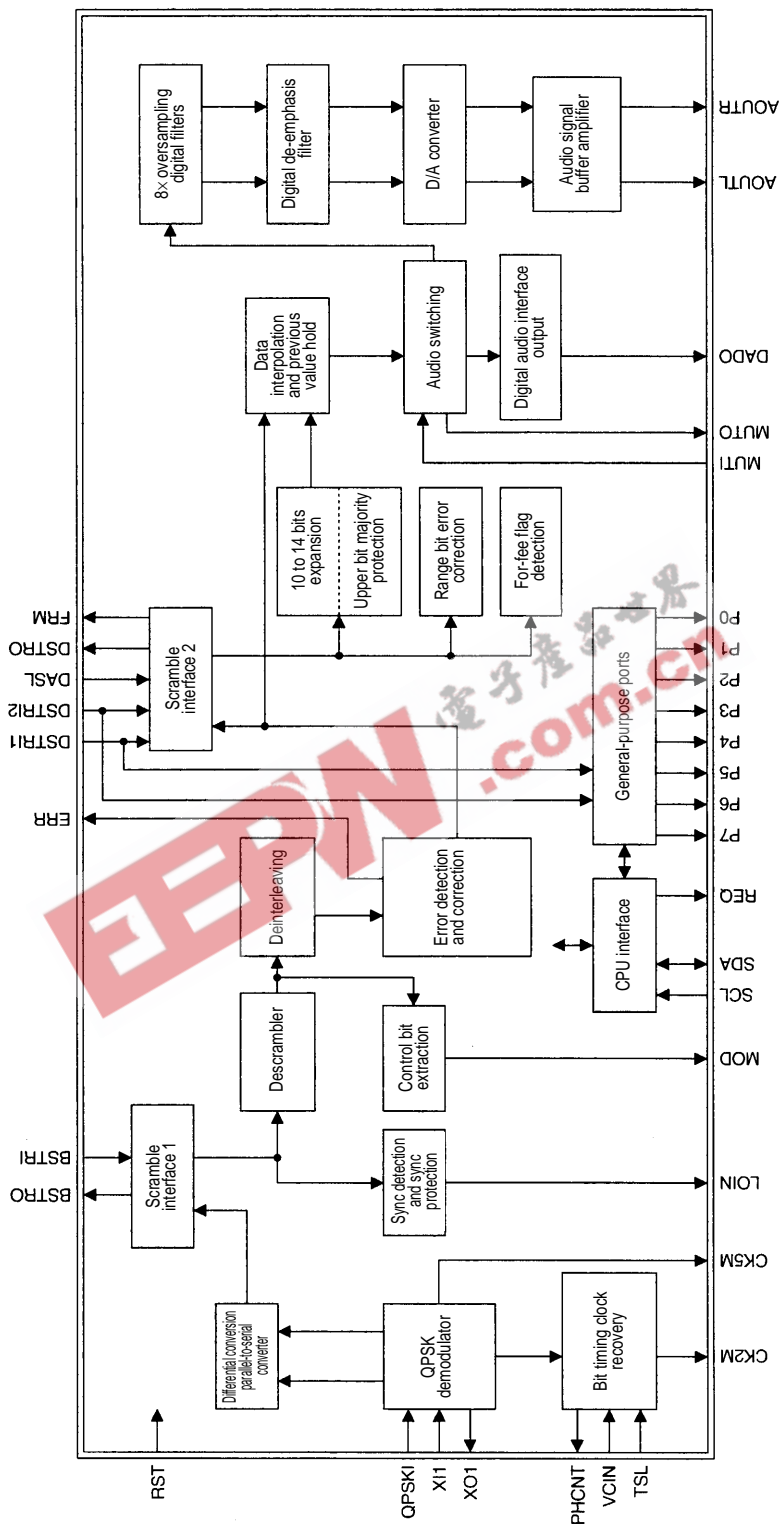

A07436

## LC7851E

### Pin Assignment

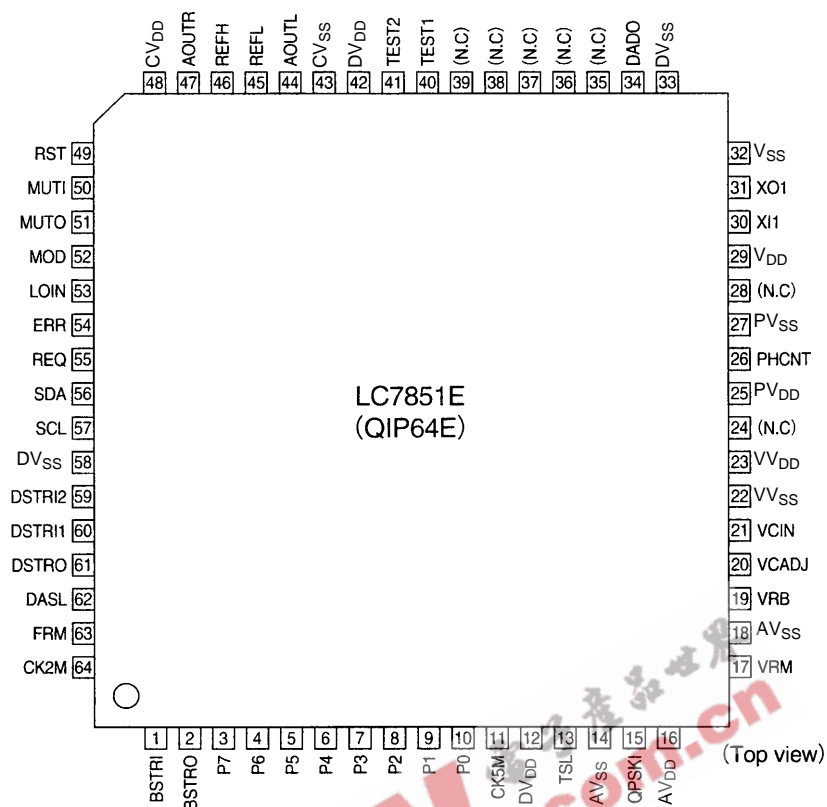

A07437

### Pin Functions

Pin No.	Pin	I/O	Function
1	BSTRI	I	Bit stream input
2	BSTRO	O	Bit stream output
3	P7	O	General-purpose output port
4	P6	O	General-purpose output port
5	P5	O	General-purpose output port
6	P4	O	General-purpose output port
7	P3	O	General-purpose output port
8	P2	O	General-purpose output port
9	P1	O	General-purpose output port
10	P0	O	General-purpose output port
11	CK5M	O	Filter adjustment clock output (5.7272 MHz)
12	DV <sub>DD</sub>	I	Digital system power supply
13	TSL	I	Output control for the state when reset by the PHCNT pin (Low: high-impedance, high: 50% duty pulse output)
14	AV <sub>SS</sub>	I	Internal A/D converter ground
15	QPSKI	I	QPSK modulated signal input
16	AV <sub>DD</sub>	I	Internal A/D converter power supply
17	VRM	O	Internal A/D converter reference (center) output
18	AV <sub>SS</sub>	I	Internal A/D converter ground
19	VRB	O	Internal A/D converter reference (low) output
20	VCADJ		Connection for internal VCO adjustment external resistor
21	VCIN	I	Internal VCO control input

Continued on next page.

## LC7851E

Continued from preceding page.

Pin No.	Pin	I/O	Function
22	VV <sub>SS</sub>	I	Internal VCO ground
23	VV <sub>DD</sub>	I	Internal VCO power supply
24	(N.C)		
25	PV <sub>DD</sub>	I	Phase comparator power supply
26	PHCNT	O	Phase comparator output
27	PV <sub>SS</sub>	I	Phase comparator ground
28	(N.C)		
29	V <sub>DD</sub>	I	Oscillator circuit power supply
30	XI1	I	Crystal oscillator (22.909088 MHz) input
31	XO1	O	Crystal oscillator (22.909088 MHz) output
32	V <sub>SS</sub>	I	Oscillator circuit ground
33	DV <sub>SS</sub>	I	Digital system ground
34	DADO	O	Digital audio interface output
35	(N.C)		
36	(N.C)		
37	(N.C)		
38	(N.C)		
39	(N.C)		
40	TEST1	I	Test pin
41	TEST2	I	Test pin
42	DV <sub>DD</sub>	I	Digital system power supply
43	CV <sub>SS</sub>	I	Internal D/A converter ground
44	AOUTL	O	Left channel audio data output
45	REFL	O	Internal D/A converter reference voltage: low
46	REFH	O	Internal D/A converter reference voltage: high
47	AOUTR	O	Right channel audio data output
48	CV <sub>DD</sub>	I	Internal D/A converter power supply
49	RST	I	Reset input
50	MUTI	I	Forced muting input
51	MUTO	O	Mute detection output (When muting detected: high)
52	MOD	O	Audio mode detection output (A mode: low, B mode: high)
53	LOIN	O	Frame synchronization detection output (When synchronized: low)
54	ERR	O	Error detection output (Error detected: high)
55	REQ	O	Host CPU readout request signal
56	SDA	I/O	I <sup>2</sup> C bus data I/O
57	SCL	I	I <sup>2</sup> C bus clock input
58	DV <sub>SS</sub>	I	Digital system ground
59	DSTRI2	I	Data stream input 2/general-purpose I/O port
60	DSTRI1	I	Data stream input 1/general-purpose I/O port
61	DSTRO	O	Data stream output (post-error correction data)
62	DASL	I	Descrambler interface switching
63	FRM	O	Frame synchronization signal
64	CK2M	O	Bit stream clock (2.048 MHz)

Caution: All NC pins must be left open.

## LC7851E

### Pin Input and Output Circuit Diagrams

- Output pins (Output pins other than P0 to P7, SDA, PHCNT, CK5M, VRM, VRB, REFH, REFL, AOUTR, and AOUTL)

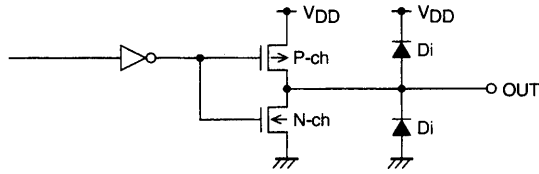

A07438

- Output pins: P0 to P7

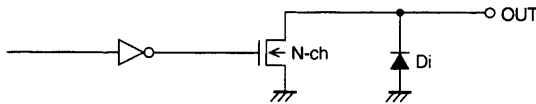

These are n-channel open drain outputs.

A07439

- Output pin: CK5M

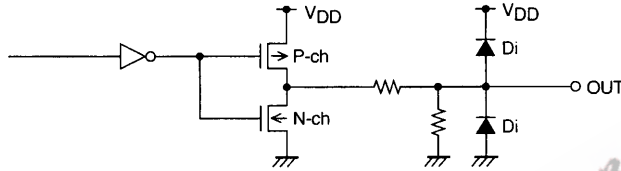

A07440

- Output pin: PHCNT

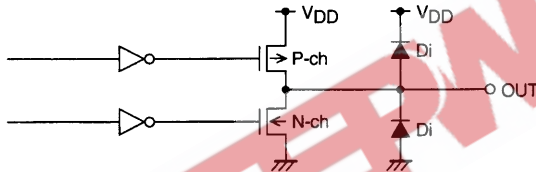

A07441

- Input pins (Input pins other than QPSKI, SCL, SDA, DSTRI1, DSTRI2, and VCIN)

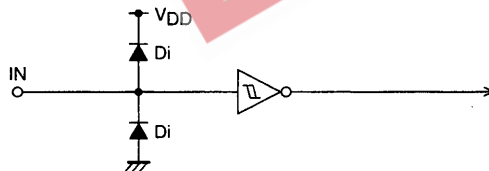

A07442

- Input pins: SCL, DSTRI1, and DSTRI2

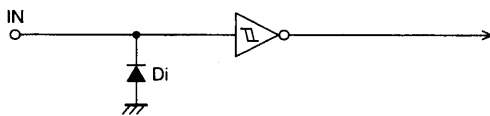

A07443

- I/O pin: SDA

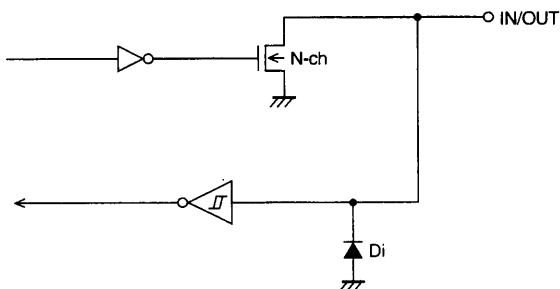

A07444

## LC7851E

### Specifications

#### Absolute Maximum Ratings at $T_a = 25^\circ\text{C}$ , $V_{SS} = 0\text{ V}$

Parameter	Symbol	Conditions	Ratings	Unit
Supply voltage	$V_{DD}$		-0.3 to +7.0	V
Input voltage	$V_{I1}$	Pins other than SCL and SDA	-0.3 to $V_{DD}+0.3$	V
	$V_{I2}$	SCL and SDA	-0.3 to +5.3	V
Output voltage	$V_O$		-0.3 to $V_{DD}+0.3$	V
Allowable power dissipation	$P_d \text{ max}$	$T_a = -20$ to $+75^\circ\text{C}$	360	mW
Operating temperature	$T_{opr}$		-20 to +75	$^\circ\text{C}$
Storage temperature	$T_{stg}$		-40 to +125	$^\circ\text{C}$

#### Allowable Operating Ranges at $T_a = 25^\circ\text{C}$

Parameter	Symbol	Conditions	Ratings			Unit
			min	typ	max	
Supply voltage	$V_{DD}$		4.5	5.0	5.5	V
Input high-level voltage	$V_{IH}$		$0.75 V_{DD}$		$V_{DD}$	V
Input low-level voltage	$V_{IL}$		0		$0.25 V_{DD}$	V
QPSKI input voltage	$V_{QPSKI}$		0.7	0.9	1.1	V

#### DC Characteristics at $T_a = -20$ to $+75^\circ\text{C}$ , $V_{DD} = 4.5$ to $5.5\text{ V}$ , $GND = 0\text{ V}$

Parameter	Symbol	Conditions	Ratings			Unit
			min	typ	max	
Current drain	$I_{DD}$			68	98	mA
Output high-level current	$I_{OH1}$	$V_{OH} = V_{DD} - 0.4\text{ V}$ ; $V_{OH} = V_{DD} - 0.4\text{ V}$ , CMOS output pins: PHCNT, LOIN, MOD, DSTRO, FRM, ERR, CK2M, BSTRO, MUTO, DADO, REQ, SYCKO	1.0			mA
	$I_{OH2}$	$V_{OH} = V_{CK5MH} - 25\text{ mV}$ , CK5M	-350		-100	$\mu\text{A}$
Output low-level current 1	$I_{OL1}$	$V_{OL} = 0.4\text{ V}$ ; CMOS output pins: PHCNT, LOIN, MOD, DSTRO, FRM, ERR, CK2M, BSTRO, MUTO, DADO, REQ, SYCKO	1.0			mA
	$I_{OL2}$	$V_{OL} = 0.4\text{ V}$ , open drain output Pin 1: P0 to P7	1.0			mA
	$I_{OL3}$	$V_{OL} = 0.4\text{ V}$ , open drain output Pin 2: SDA	4.0			mA
	$I_{OL4}$	$V_{OL} = V_{CK5ML} + 25\text{ mV}$ , CK5M	100		350	$\mu\text{A}$
Output amplitude level	$V_{CK5M}$	$I_{OH} = 30\text{ }\mu\text{A}$ , CK5M	236	295	354	mV
Input high-level current	$I_{IH}$	$V_I = V_{DD}$ , Schmitt inputs: TSL, RST, TEST1, TEST2, BSTRI, DSTRI1, DSTRI2, DASL, MUTI, SCL, SDA, P0 to P7			10	$\mu\text{A}$
Input low-level current	$I_{IL}$	$V_I = V_{SS}$ , Schmitt inputs: TSL, RST, TEST1, TEST2, BSTRI, DSTRI1, DSTRI2, DASL, MUTI, SCL, SDA, P0 to P7	-10			$\mu\text{A}$
Output load resistance	$R_L$	AOUTL and AOUTR	5.0			k $\Omega$

#### D/A Converter Characteristics at $T_a = -20$ to $+75^\circ\text{C}$ , $V_{DD} = 4.5$ to $5.5\text{ V}$ , $GND = 0\text{ V}$

Parameter	Symbol	Conditions	Ratings			Unit
			min	typ	max	
Resolution	RES	1 kHz 0 dB		16		Bits
Total harmonic distortion	THD1	1 kHz A mode, FS - 18 dB *		0.08		%
	THD2	1 kHz B mode, FS - 18 dB *		0.05		%
Signal-to-noise ratio	S/N	1 kHz 0 dB *		105		dB
Crosstalk	C. T	1 kHz 0 dB *		95		dB
Full scale output voltage	VFS		2.8	3.0	3.2	Vp-p

Note: \*Values when measured in the Sanyo evaluation board and with a QPSK modulated signal (1 kHz sine wave) input.

## LC7851E

### I<sup>2</sup>C Bus Interface at Ta = -20 to +75°C, V<sub>DD</sub> = 4.5 to 5.5 V, GND = 0 V

Parameter	Symbol	Conditions	Ratings			Unit
			min	typ	max	
SCL frequency	f <sub>SCL</sub>				100	kHz
Bus release time	T <sub>BUF</sub>		4.7			μs
Start hold time	T <sub>HD STA</sub>		4.0			μs
SCL low time	T <sub>LOW</sub>		4.7			μs
SCL high time	T <sub>HIGH</sub>		4.0			μs
Data hold time	T <sub>HD DAT</sub>		0			ns
Data setup time	T <sub>SU DAT</sub>		250			ns
Rise time	T <sub>R</sub>				1000	ns
Fall time	T <sub>F</sub>				300	ns
Stop setup time	T <sub>SU STO</sub>		4.0			μs

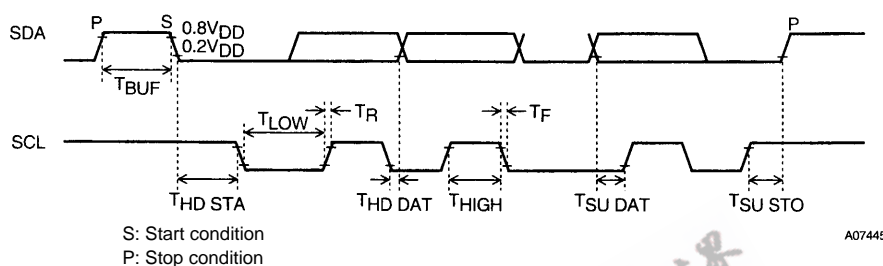

### Descrambler Interface at Ta = -20 to +75°C, V<sub>DD</sub> = 4.5 to 5.5 V, GND = 0 V

Parameter	Symbol	Conditions	Ratings			Unit
			min	typ	max	
Clock pulse width	T <sub>CK2M</sub>		244			ns
BSTRO pin output delay time	T <sub>BSDL</sub>				15	ns
DSTRO pin output delay time	T <sub>DSDL</sub>				15	ns
BSTRI and DSTRI1 two-pin input setup time	T <sub>BSST</sub>		10			ns

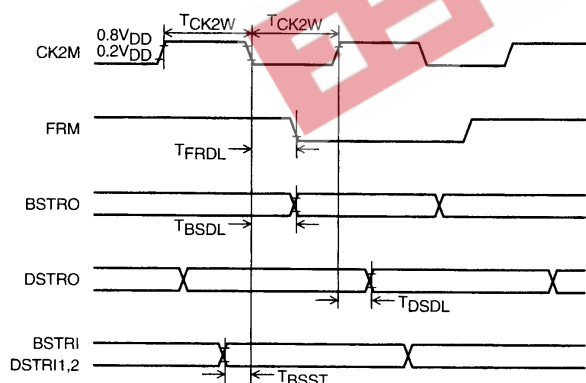

### Reset Timing at Power on at Ta = -20 to +75°C, V<sub>DD</sub> = 4.5 to 5.5 V, GND = 0 V

Parameter	Symbol	Conditions	Ratings			Unit
			min	typ	max	
Reset time	T <sub>RST</sub>	TSL pin high; The LC7851E must be used with the TSL pin (pin 13) high.	200			ms

The LC7851E must be reset with the following timing when power is first applied.

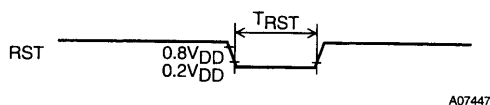

### Pin I/O Circuit

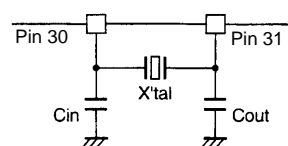

### Recommended Crystal Oscillator Constants

Supplier	Oscillator element	Cin/Cout
Citizen Watch Co., Ltd.	CSA-309 (22.909088 MHz)	5pF (Cin = Cout)

A07448

LC7851E

Application Circuit Diagram

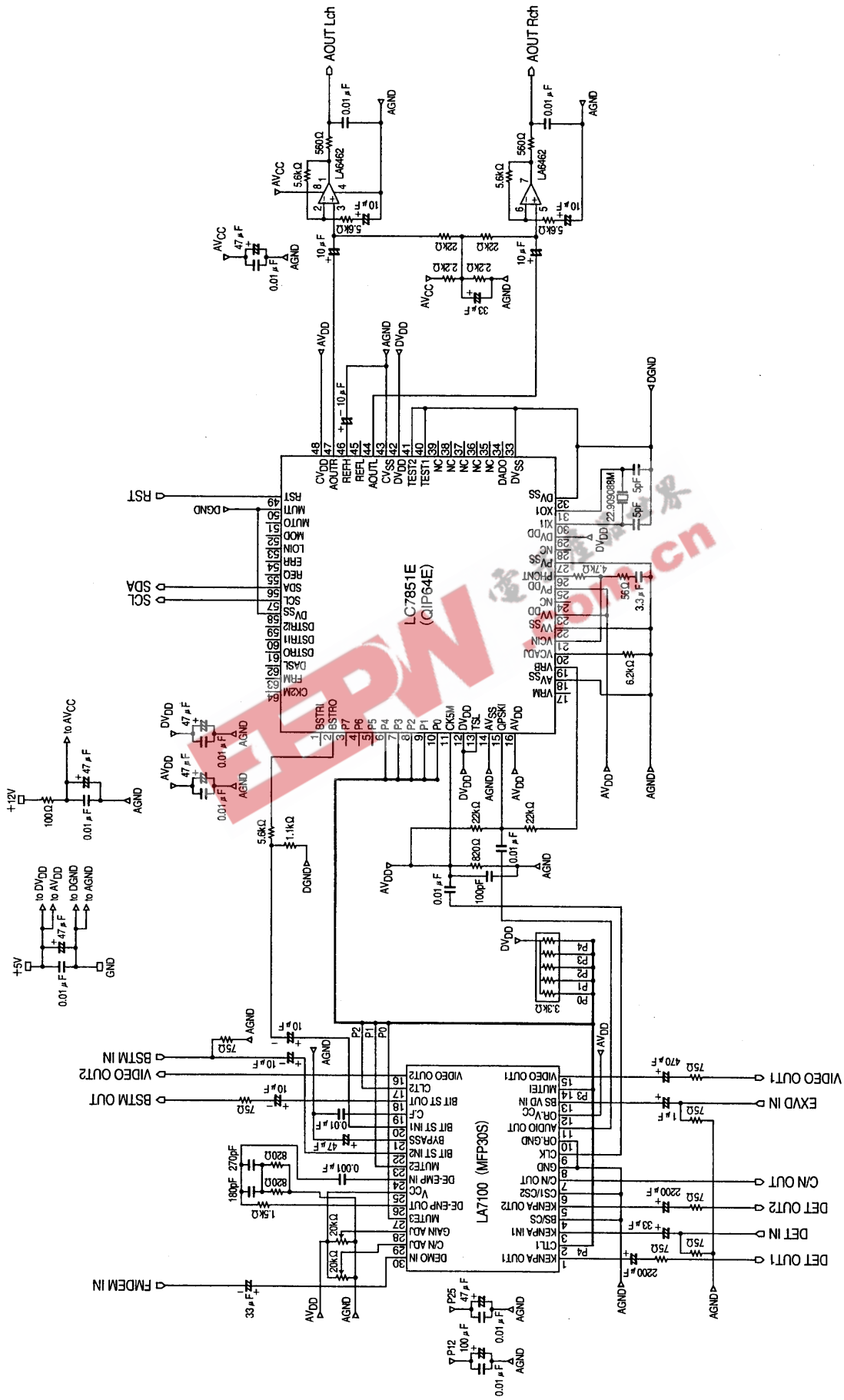

A07449



EEPW 电子產品世界  
.com.cn

- No products described or contained herein are intended for use in surgical implants, life-support systems, aerospace equipment, nuclear power control systems, vehicles, disaster/crime-prevention equipment and the like, the failure of which may directly or indirectly cause injury, death or property loss.
- Anyone purchasing any products described or contained herein for an above-mentioned use shall:
  - ① Accept full responsibility and indemnify and defend SANYO ELECTRIC CO., LTD., its affiliates, subsidiaries and distributors and all their officers and employees, jointly and severally, against any and all claims and litigation and all damages, cost and expenses associated with such use:
  - ② Not impose any responsibility for any fault or negligence which may be cited in any such claim or litigation on SANYO ELECTRIC CO., LTD., its affiliates, subsidiaries and distributors or any of their officers and employees jointly or severally.
- Information (including circuit diagrams and circuit parameters) herein is for example only; it is not guaranteed for volume production. SANYO believes information herein is accurate and reliable, but no guarantees are made or implied regarding its use or any infringements of intellectual property rights or other rights of third parties.

This catalog provides information as of August, 1997. Specifications and information herein are subject to change without notice.