

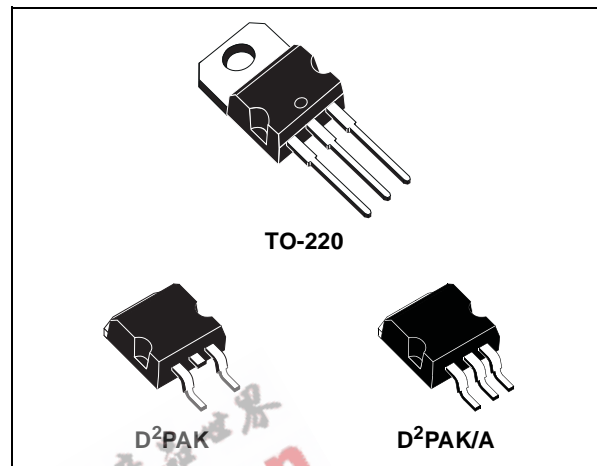

## 5A LOW DROPOUT FAST RESPONSE POSITIVE VOLTAGE REGULATOR ADJUSTABLE AND FIXED

- TYPICAL DROPOUT 1.2V
- FAST TRANSIENT RESPONSE
- THREE TERMINAL ADJUSTABLE OR FIXED OUTPUT VOLTAGE 1.5V, 1.8V, 2.5V, 2.85V, 3.3V, 5V, 8V, 9V, 12V.
- GUARANTEED OUTPUT CURRENT UP TO 5A
- OUTPUT TOLERANCE  $\pm 1\%$  AT 25°C AND  $\pm 2\%$  IN FULL TEMPERATURE RANGE
- INTERNAL POWER AND THERMAL LIMIT
- WIDE OPERATING TEMPERATURE RANGE 0°C TO 125°C
- PACKAGE AVAILABLE : TO-220, D<sup>2</sup>PAK, D<sup>2</sup>PAK/A
- PINOUT COMPATIBILITY WITH STANDARD ADJUSTABLE VREG



### DESCRIPTION

The LD1585C is a LOW DROP Voltage Regulator able to provide up to 5A of Output Current. Dropout is guaranteed at a maximum of 1.4V at the maximum output current, decreasing at lower loads. The device has been improved to be utilized in low voltage applications where transient response and minimum input voltage are critical. The most important feature of the device consist in lower dropout voltage and very fast transient

response. A 2.85V output version is suitable for SCSI-2 active termination. Unlike PNP regulators, where a part of the output current is wasted as quiescent current, the LD1585C quiescent current flows into the load, so increase efficiency. Only a 10 $\mu$ F minimum capacitor is need for stability. The device is supplied in TO-220, D<sup>2</sup>PAK and D<sup>2</sup>PAK/A. On chip trimming allows the regulator to reach a very tight output voltage tolerance, within  $\pm 1\%$  at 25°C.

### SCHEMATIC DIAGRAM

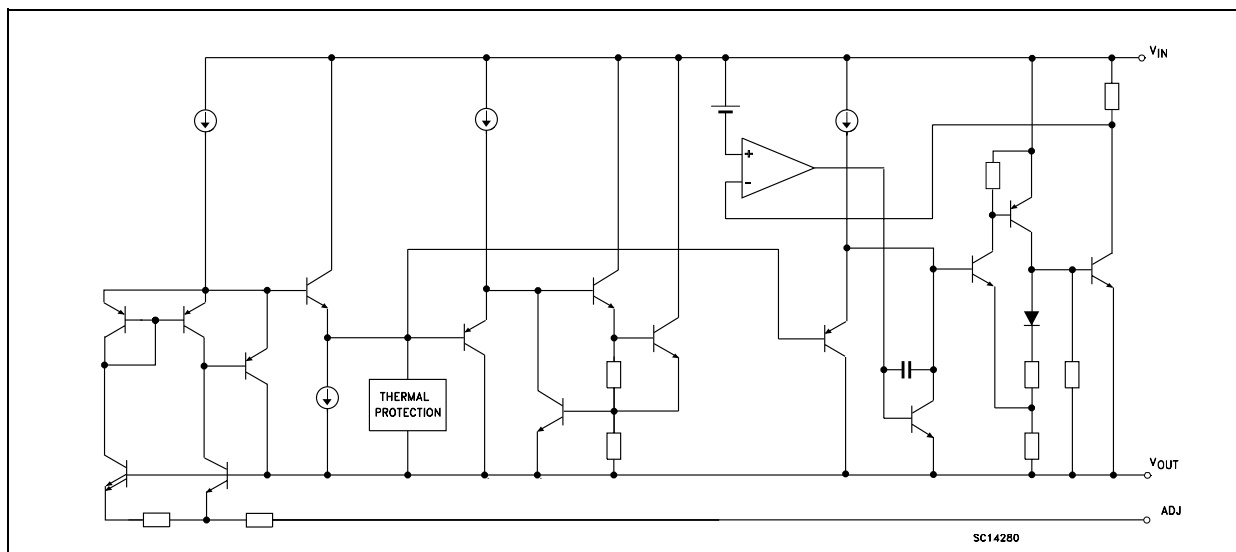

## LD1585C SERIES

### ABSOLUTE MAXIMUM RATINGS

Symbol	Parameter <sup>2</sup>	Value	Unit
$V_I$	DC Input Voltage	30	V
$I_O$	Output Current	Internally Limited	mA
$P_D$	Power Dissipation	Internally Limited	mW
$T_{stg}$	Storage Temperature Range	-55 to +150	°C
$T_{op}$	Operating Junction Temperature Range	0 to +125	°C

Absolute Maximum Ratings are those values beyond which damage to the device may occur. Functional operation under these condition is not implied.

### THERMAL DATA

Symbol	Parameter	TO-220	D <sup>2</sup> PAK	Unit
$R_{thj-case}$	Thermal Resistance Junction-case	3	3	°C/W
$R_{thj-amb}$	Thermal Resistance Junction-ambient	50	62.5	°C/W

### APPLICATION CIRCUITS

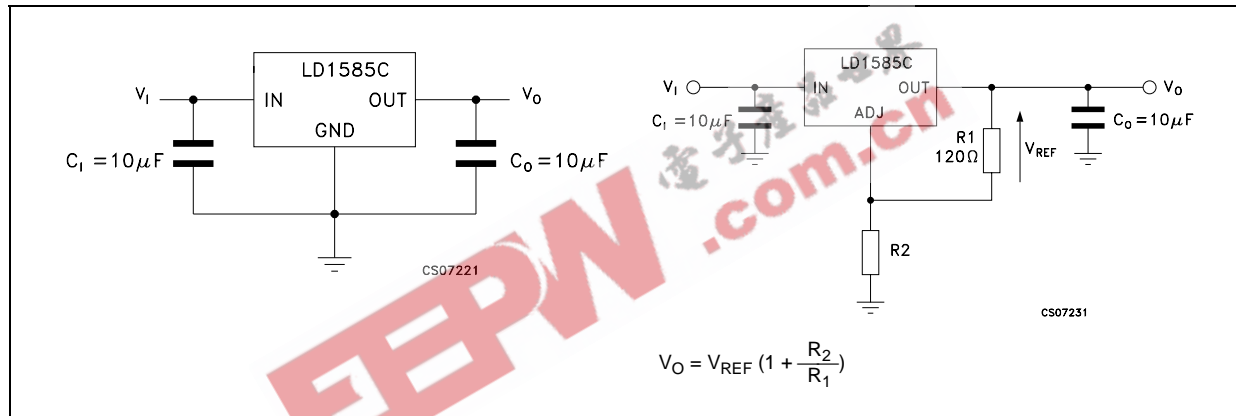

CONNECTION DIAGRAM (top view)

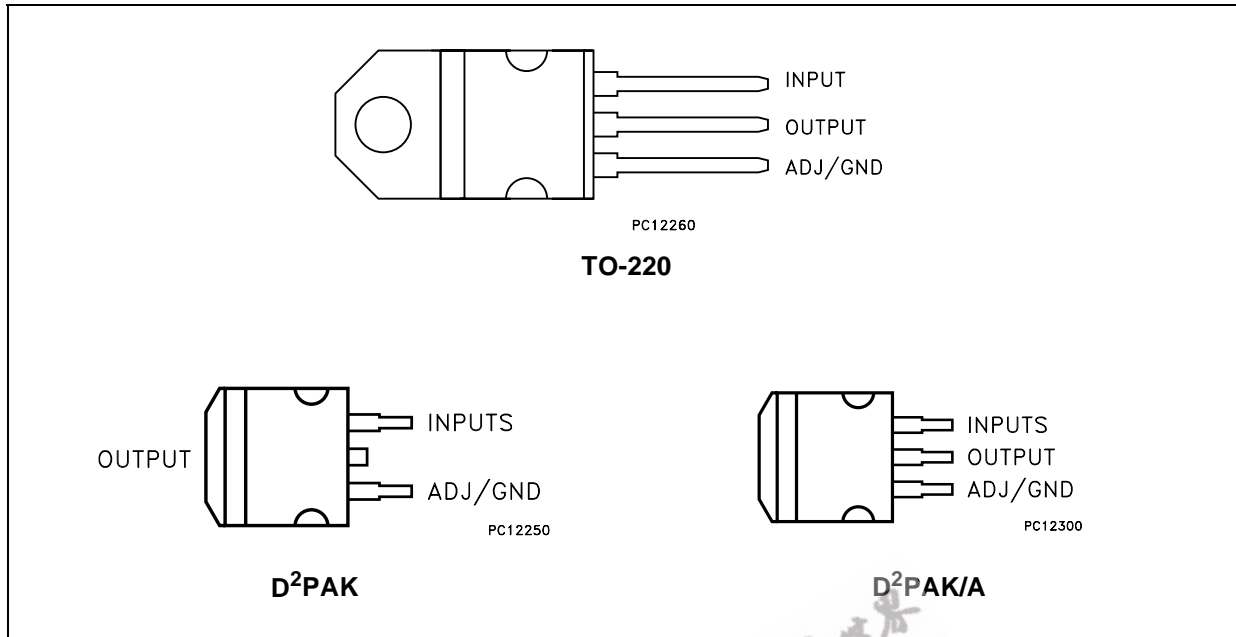

ORDERING CODES

TO-220	D <sup>2</sup> PAK (*)	D <sup>2</sup> PAK/A (*)	OUTPUT VOLTAGE
LD1585CV15	LD1585CD2T15	LD1585CD2M15	1.5 V
LD1585CV18	LD1585CD2T18	LD1585CD2M18	1.8 V
LD1585CV25	LD1585CD2T25	LD1585CD2M25	2.5 V
LD1585CV28	LD1585CD2T28	LD1585CD2M28	2.85 V
LD1585CV33	LD1585CD2T33	LD1585CD2M33	3.3 V
LD1585CV50	LD1585CD2T50	LD1585CD2M50	5.0 V
LD1585CV80	LD1585CD2T80	LD1585CD2M80	8.0 V
LD1585CV90	LD1585CD2T90	LD1585CD2M90	9.0 V
LD1585CV12	LD1585CD2T120	LD1585CD2M120	12.0 V
LD1585CV	LD1585CD2T	LD1585CD2M	ADJ

(\*) Available in Tape & Reel with the suffix "R" for fixed version and "-R" for adjustable version.

## LD1585C SERIES

**ELECTRICAL CHARACTERISTICS OF LD1585#15** ( $V_I=4.5V$ ,  $C_I = C_O = 10\mu F$ ,  $T_J = 0$  to  $125^\circ C$ , unless otherwise specified.)

Symbol	Parameter	Test Conditions	Min.	Typ.	Max.	Unit
$V_O$	Output Voltage	$I_O = 0$ mA $T_J = 25^\circ C$	1.485	1.5	1.515	V
		$I_O = 0$ to 5A $V_I = 3$ to 25V (note 1)	1.47	1.5	1.53	V
$\Delta V_O$	Line Regulation	$I_O = 0$ mA $V_I = 3$ to 15V $T_J = 25^\circ C$		0.005	0.2	%
		$I_O = 0$ mA $V_I = 3$ to 15V		0.005	0.2	%
$\Delta V_O$	Load Regulation	$I_O = 0$ to 5A $T_J = 25^\circ C$		0.05	0.3	%
		$I_O = 0$ to 5A		0.05	0.5	%
$V_d$	Dropout Voltage	$I_O = 5$ A		1.2	1.4	V
$I_q$	Quiescent Current	$V_I \leq 25V$		5	10	mA
$I_{sc}$	Short Circuit Current	$V_I - V_O = 5V$	5.5	7		A
	Thermal Regulation	$T_J = 25^\circ C$ , 30ms pulse		0.004	0.02	%/W
SVR	Supply Voltage Rejection	$f = 120$ Hz, $C_O = 25 \mu F$ , $I_O = 5A$ $V_I - V_O = 3 \pm 1V$	60	75		dB
eN	RMS Output Noise Voltage (% of $V_O$ )	$T_J = 25^\circ C$ $f = 10$ Hz to 10KHz		0.003		%
S	Temperature Stability			0.5		%
S	Long Term Stability	$T_J = 125^\circ C$ 1000Hrs		0.03	1	%

NOTE 1: See short-circuit current curve for available output current at fixed dropout.

**ELECTRICAL CHARACTERISTICS OF LD1585#18** ( $V_I=4.8V$ ,  $C_I = C_O = 10\mu F$ ,  $T_J = 0$  to  $125^\circ C$ , unless otherwise specified.)

Symbol	Parameter	Test Conditions	Min.	Typ.	Max.	Unit
$V_O$	Output Voltage	$I_O = 0$ mA $T_J = 25^\circ C$	1.782	1.8	1.818	V
		$I_O = 0$ to 5A $V_I = 3.3$ to 25V (note 1)	1.764	1.8	1.836	V
$\Delta V_O$	Line Regulation	$I_O = 0$ mA $V_I = 3.3$ to 15V $T_J = 25^\circ C$		0.005	0.2	mV
		$I_O = 0$ mA $V_I = 3.3$ to 15V		0.005	0.2	mV
$\Delta V_O$	Load Regulation	$I_O = 0$ to 5A $T_J = 25^\circ C$		0.05	0.3	mV
		$I_O = 0$ to 5A		0.05	0.5	mV
$V_d$	Dropout Voltage	$I_O = 5$ A		1.2	1.4	V
$I_q$	Quiescent Current	$V_I \leq 25V$		5	10	mA
$I_{sc}$	Short Circuit Current	$V_I - V_O = 5.5V$	5.5	7		A
	Thermal Regulation	$T_J = 25^\circ C$ , 30ms pulse		0.004	0.02	%/W
SVR	Supply Voltage Rejection	$f = 120$ Hz, $C_O = 25 \mu F$ , $I_O = 5A$ $V_I - V_O = 3 \pm 1V$	60	75		dB
eN	RMS Output Noise Voltage (% of $V_O$ )	$T_J = 25^\circ C$ $f = 10$ Hz to 10KHz		0.003		%
S	Temperature Stability			0.5		%
S	Long Term Stability	$T_J = 125^\circ C$ 1000Hrs		0.03	1	%

NOTE 1: See short-circuit current curve for available output current at fixed dropout.

**ELECTRICAL CHARACTERISTICS OF LD1585#25** ( $V_I=5.5V$ ,  $C_I = C_O = 10\mu F$ ,  $T_J = 0$  to  $125^\circ C$ , unless otherwise specified.)

Symbol	Parameter	Test Conditions	Min.	Typ.	Max.	Unit
$V_O$	Output Voltage	$I_O = 0$ mA $T_J = 25^\circ C$	2.475	2.5	2.525	V
		$I_O = 0$ to 5A $V_I = 4$ to 25V (note 1)	2.45	2.5	2.55	V
$\Delta V_O$	Line Regulation	$I_O = 0$ mA $V_I = 4$ to 16V $T_J = 25^\circ C$		0.005	0.2	mV
		$I_O = 0$ mA $V_I = 4$ to 16V		0.005	0.2	
$\Delta V_O$	Load Regulation	$I_O = 0$ to 5A $T_J = 25^\circ C$		0.05	0.3	mV
		$I_O = 0$ to 5A		0.05	0.5	
$V_d$	Dropout Voltage	$I_O = 5$ A		1.2	1.4	V
$I_q$	Quiescent Current	$V_I \leq 25V$		5	10	mA
$I_{sc}$	Short Circuit Current	$V_I - V_O = 5.5V$	5.5	7		A
	Thermal Regulation	$T_J = 25^\circ C$ , 30ms pulse		0.004	0.02	%/W
SVR	Supply Voltage Rejection	$f = 120$ Hz, $C_O = 25 \mu F$ , $I_O = 5A$ $V_I - V_O = 3 \pm 1V$	60	75		dB
eN	RMS Output Noise Voltage (% of $V_O$ )	$T_J = 25^\circ C$ $f = 10$ Hz to 10KHz		0.003		%
S	Temperature Stability			0.5		%
S	Long Term Stability	$T_J = 125^\circ C$ 1000Hrs		0.03	1	%

NOTE 1: See short-circuit current curve for available output current at fixed dropout.

**ELECTRICAL CHARACTERISTICS OF LD1585#285** ( $V_I=5.85V$ ,  $C_I = C_O = 10\mu F$ ,  $T_J = 0$  to  $125^\circ C$ , unless otherwise specified.)

Symbol	Parameter	Test Conditions	Min.	Typ.	Max.	Unit
$V_O$	Output Voltage	$I_O = 0$ mA $T_J = 25^\circ C$	2.821	2.85	2.879	V
		$I_O = 0$ to 5A $V_I = 4.5$ to 30V (note 1)	2.793	2.85	2.907	V
$\Delta V_O$	Line Regulation	$I_O = 0$ mA $V_I = 4.5$ to 18V $T_J = 25^\circ C$		0.005	0.2	mV
		$I_O = 0$ mA $V_I = 4.5$ to 18V		0.005	0.2	
$\Delta V_O$	Load Regulation	$I_O = 0$ to 5A $T_J = 25^\circ C$		0.05	0.3	mV
		$I_O = 0$ to 5A		0.05	0.5	
$V_d$	Dropout Voltage	$I_O = 5$ A		1.2	1.4	V
$I_q$	Quiescent Current	$V_I \leq 25V$		5	10	mA
$I_{sc}$	Short Circuit Current	$V_I - V_O = 5.5V$	5.5	7		A
	Thermal Regulation	$T_J = 25^\circ C$ , 30ms pulse		0.004	0.02	%/W
SVR	Supply Voltage Rejection	$f = 120$ Hz, $C_O = 25 \mu F$ , $I_O = 5A$ $V_I - V_O = 3 \pm 1V$	60	75		dB
eN	RMS Output Noise Voltage (% of $V_O$ )	$T_J = 25^\circ C$ $f = 10$ Hz to 10KHz		0.003		%
S	Temperature Stability			0.5		%
S	Long Term Stability	$T_J = 125^\circ C$ 1000Hrs		0.03	1	%

NOTE 1: See short-circuit current curve for available output current at fixed dropout.

## LD1585C SERIES

**ELECTRICAL CHARACTERISTICS OF LD1585#33** ( $V_I=6.3V$ ,  $C_I = C_O = 10\mu F$ ,  $T_J = 0$  to  $125^\circ C$ , unless otherwise specified.)

Symbol	Parameter	Test Conditions	Min.	Typ.	Max.	Unit
$V_O$	Output Voltage	$I_O = 0$ mA $T_J = 25^\circ C$	3.267	3.3	3.333	V
		$I_O = 0$ to 5A $V_I = 4.8$ to 25V (note 1)	3.234	3.35	3.366	V
$\Delta V_O$	Line Regulation	$I_O = 0$ mA $V_I = 4.8$ to 18V $T_J = 25^\circ C$		0.005	0.2	mV
		$I_O = 0$ mA $V_I = 4.9$ to 18V		0.005	0.2	
$\Delta V_O$	Load Regulation	$I_O = 0$ to 5A $T_J = 25^\circ C$		0.05	0.3	mV
		$I_O = 0$ to 5A		0.05	0.5	
$V_d$	Dropout Voltage	$I_O = 5$ A		1.2	1.4	V
$I_q$	Quiescent Current	$V_I \leq 25V$		5	10	mA
$I_{sc}$	Short Circuit Current	$V_I - V_O = 5.5V$	5.5	7		A
	Thermal Regulation	$T_J = 25^\circ C$ , 30ms pulse		0.004	0.02	%/W
SVR	Supply Voltage Rejection	$f = 120$ Hz, $C_O = 25 \mu F$ , $I_O = 5A$ $V_I - V_O = 3 \pm 1V$	60	75		dB
eN	RMS Output Noise Voltage (% of $V_O$ )	$T_J = 25^\circ C$ $f = 10Hz$ to 10KHz		0.003		%
S	Temperature Stability			0.5		%
S	Long Term Stability	$T_J = 125^\circ C$ 1000Hrs		0.03	1	%

NOTE 1: See short-circuit current curve for available output current at fixed dropout.

**ELECTRICAL CHARACTERISTICS OF LD1585#50** ( $V_I=8V$ ,  $C_I = C_O = 10\mu F$ ,  $T_J = 0$  to  $125^\circ C$ , unless otherwise specified.)

Symbol	Parameter	Test Conditions	Min.	Typ.	Max.	Unit
$V_O$	Output Voltage	$I_O = 0$ mA $T_J = 25^\circ C$	4.95	5	5.05	V
		$I_O = 0$ to 5A $V_I = 6.5$ to 30V (note 1)	4.9	5	5.1	V
$\Delta V_O$	Line Regulation	$I_O = 0$ mA $V_I = 6.5$ to 20V $T_J = 25^\circ C$		0.005	0.2	mV
		$I_O = 0$ mA $V_I = 6.5$ to 20V		0.005	0.2	
$\Delta V_O$	Load Regulation	$I_O = 0$ to 5A $T_J = 25^\circ C$		0.05	0.3	mV
		$I_O = 0$ to 5A		0.05	0.5	
$V_d$	Dropout Voltage	$I_O = 5$ A		1.2	1.4	V
$I_q$	Quiescent Current	$V_I \leq 25V$		5	10	mA
$I_{sc}$	Short Circuit Current	$V_I - V_O = 5.5V$	5.5	7		A
	Thermal Regulation	$T_J = 25^\circ C$ , 30ms pulse		0.004	0.02	%/W
SVR	Supply Voltage Rejection	$f = 120$ Hz, $C_O = 25 \mu F$ , $I_O = 5A$ $V_I - V_O = 3 \pm 1V$	60	75		dB
eN	RMS Output Noise Voltage (% of $V_O$ )	$T_J = 25^\circ C$ $f = 10Hz$ to 10KHz		0.003		%
S	Temperature Stability			0.5		%
S	Long Term Stability	$T_J = 125^\circ C$ 1000Hrs		0.03	1	%

NOTE 1: See short-circuit current curve for available output current at fixed dropout.

**ELECTRICAL CHARACTERISTICS OF LD1585#80** ( $V_I=11V$ ,  $C_I = C_O = 10\mu F$ ,  $T_J = 0$  to  $125^\circ C$ , unless otherwise specified.)

Symbol	Parameter	Test Conditions	Min.	Typ.	Max.	Unit
$V_O$	Output Voltage	$I_O = 0$ mA $T_J = 25^\circ C$	7.92	8	8.08	V
		$I_O = 0$ to 5A $V_I = 9.5$ to 30V (note 1)	7.84	8	8.16	V
$\Delta V_O$	Line Regulation	$I_O = 0$ mA $V_I = 9.5$ to 20V $T_J = 25^\circ C$		0.005	0.2	mV
		$I_O = 0$ mA $V_I = 9.5$ to 20V		0.005	0.2	
$\Delta V_O$	Load Regulation	$I_O = 0$ to 5A $T_J = 25^\circ C$		0.05	0.3	mV
		$I_O = 0$ to 5A		0.05	0.5	
$V_d$	Dropout Voltage	$I_O = 5$ A		1.2	1.4	V
$I_q$	Quiescent Current	$V_I \leq 25V$		5	10	mA
$I_{sc}$	Short Circuit Current	$V_I - V_O = 5.5V$	5.5	7		A
	Thermal Regulation	$T_J = 25^\circ C$ , 30ms pulse		0.004	0.02	%/W
SVR	Supply Voltage Rejection	$f = 120$ Hz, $C_O = 25 \mu F$ , $I_O = 5A$ $V_I - V_O = 3 \pm 1V$	60	75		dB
eN	RMS Output Noise Voltage (% of $V_O$ )	$T_J = 25^\circ C$ $f = 10$ Hz to 10KHz		0.003		%
S	Temperature Stability			0.5		%
S	Long Term Stability	$T_J = 125^\circ C$ 1000Hrs		0.03	1	%

NOTE 1: See short-circuit current curve for available output current at fixed dropout.

**ELECTRICAL CHARACTERISTICS OF LD1585#90** ( $V_I=12V$ ,  $C_I = C_O = 10\mu F$ ,  $T_J = 0$  to  $125^\circ C$ , unless otherwise specified.)

Symbol	Parameter	Test Conditions	Min.	Typ.	Max.	Unit
$V_O$	Output Voltage	$I_O = 0$ mA $T_J = 25^\circ C$	8.91	9	9.09	V
		$I_O = 0$ to 5A $V_I = 10.5$ to 30V (note 1)	8.82	9	9.18	V
$\Delta V_O$	Line Regulation	$I_O = 0$ mA $V_I = 10.5$ to 20V $T_J = 25^\circ C$		0.005	0.2	mV
		$I_O = 0$ mA $V_I = 10.5$ to 20V		0.005	0.2	
$\Delta V_O$	Load Regulation	$I_O = 0$ to 5A $T_J = 25^\circ C$		0.05	0.3	mV
		$I_O = 0$ to 5A		0.05	0.5	
$V_d$	Dropout Voltage	$I_O = 5$ A		1.2	1.4	V
$I_q$	Quiescent Current	$V_I \leq 25V$		5	10	mA
$I_{sc}$	Short Circuit Current	$V_I - V_O = 5.5V$	5.5	7		A
	Thermal Regulation	$T_J = 25^\circ C$ , 30ms pulse		0.004	0.02	%/W
SVR	Supply Voltage Rejection	$f = 120$ Hz, $C_O = 25 \mu F$ , $I_O = 5A$ $V_I - V_O = 3 \pm 1V$	60	75		dB
eN	RMS Output Noise Voltage (% of $V_O$ )	$T_J = 25^\circ C$ $f = 10$ Hz to 10KHz		0.003		%
S	Temperature Stability			0.5		%
S	Long Term Stability	$T_J = 125^\circ C$ 1000Hrs		0.03	1	%

NOTE 1: See short-circuit current curve for available output current at fixed dropout.

## LD1585C SERIES

**ELECTRICAL CHARACTERISTICS OF LD1585#120** ( $V_I=15V$ ,  $C_I = C_O = 10\mu F$ ,  $T_J = 0$  to  $125^\circ C$ , unless otherwise specified.)

Symbol	Parameter	Test Conditions	Min.	Typ.	Max.	Unit
$V_O$	Output Voltage	$I_O = 0 \text{ mA}$ $T_J = 25^\circ C$	11.88	12	12.12	V
		$I_O = 0$ to $5A$ $V_I = 13.5$ to $30V$ (note 1)	11.76	12	12.24	V
$\Delta V_O$	Line Regulation	$I_O = 0 \text{ mA}$ $V_I = 13.5$ to $25V$ $T_J = 25^\circ C$		0.005	0.2	mV
		$I_O = 0 \text{ mA}$ $V_I = 13.5$ to $25V$		0.005	0.2	
$\Delta V_O$	Load Regulation	$I_O = 0$ to $5A$ $T_J = 25^\circ C$		0.05	0.3	mV
		$I_O = 0$ to $5A$		0.05	0.5	
$V_d$	Dropout Voltage	$I_O = 5 \text{ A}$		1.2	1.4	V
$I_q$	Quiescent Current	$V_I \leq 25V$		5	10	mA
$I_{sc}$	Short Circuit Current	$V_I - V_O = 5.5V$	5.5	7		A
	Thermal Regulation	$T_J = 25^\circ C$ , 30ms pulse		0.004	0.02	%/W
SVR	Supply Voltage Rejection	$f = 120 \text{ Hz}$ , $C_O = 25 \mu F$ , $I_O = 5A$ $V_I - V_O = 3 \pm 1V$	60	75		dB
eN	RMS Output Noise Voltage (% of $V_O$ )	$T_J = 25^\circ C$ $f = 10\text{Hz}$ to $10\text{KHz}$		0.003		%
S	Temperature Stability			0.5		%
S	Long Term Stability	$T_J = 125^\circ C$ 1000Hrs		0.03	1	%

NOTE 1: See short-circuit current curve for available output current at fixed dropout.

**ELECTRICAL CHARACTERISTICS OF LD1585#** ( $V_I=4.25V$ ,  $C_I = C_O = 10\mu F$ ,  $T_J = 0$  to  $125^\circ C$ , unless otherwise specified.)

Symbol	Parameter	Test Conditions	Min.	Typ.	Max.	Unit
$V_O$	Output Voltage	$I_O = 10\text{mA}$ $V_I - V_O = 3V$ $T_J = 25^\circ C$	1.237	1.25	1.263	V
		$I_O = 10\text{mA}$ to $5A$ $V_I - V_O = 1.5$ to $25V$ (note 1)	1.225	1.25	1.275	V
$\Delta V_O$	Line Regulation	$I_O = 10\text{mA}$ $V_I = 2.75$ to $15V$ $T_J = 25^\circ C$		0.015	0.2	%
		$I_O = 10\text{mA}$ $V_I = 2.75$ to $15V$		0.1	0.2	%
$\Delta V_O$	Load Regulation	$I_O = 10\text{mA}$ to $5A$ $T_J = 25^\circ C$		0.1	0.3	%
		$I_O = 0$ to $5A$		0.25	0.5	%
$V_d$	Dropout Voltage	$I_O = 5A$		1.2	1.4	V
$I_{O(\text{min})}$	Minimum Load Current	$V_I = 25V$		3	10	mA
$I_{sc}$	Short Circuit Current	$V_I - V_O = 5.5V$	5.5	7		A
	Thermal Regulation	$T_J = 25^\circ C$ , 30ms pulse		0.004	0.02	%/W
SVR	Supply Voltage Rejection	$f = 120 \text{ Hz}$ , $C_O = 25 \mu F$ , $C_{ADJ} = 25 \mu F$ , $I_O = 5A$ $V_I - V_O = 3 \pm 1V$	60	75		dB
$I_{ADJ}$	Adjust Pin Current	$I_O = 10 \text{ mA}$		50	100	$\mu A$
$\Delta I_{ADJ}$	Adjust Pin Current Change	$I_O = 10\text{mA}$ to $5A$ $V_I = 3$ to $25V$ (note 1)		0.2	5	$\mu A$
eN	RMS Output Noise Voltage (% of $V_O$ )	$T_J = 25^\circ C$ $f = 10\text{Hz}$ to $10\text{KHz}$		0.003		%
S	Temperature Stability			0.5		%
S	Long Term Stability	$T_J = 125^\circ C$ 1000Hrs		0.5		%

NOTE 1: See short-circuit current curve for available output current at fixed dropout.



**TYPICAL CHARACTERISTICS** (unless otherwise specified  $T_j = 25^\circ\text{C}$ ,  $C_I=C_O=10\mu\text{F}$  tant)

**Figure 1 : Output Voltage vs Temperature**

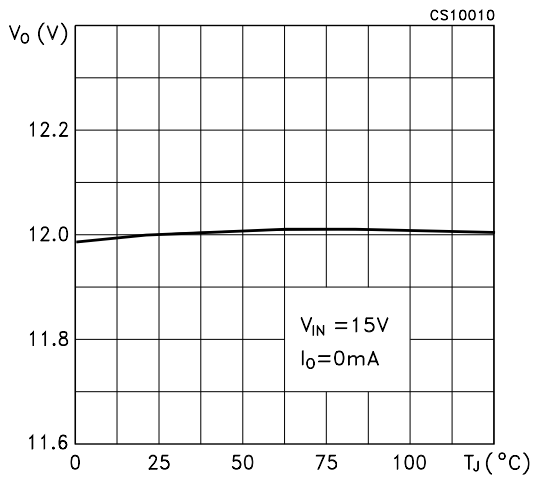

**Figure 4 : Line Regulation vs Temperature**

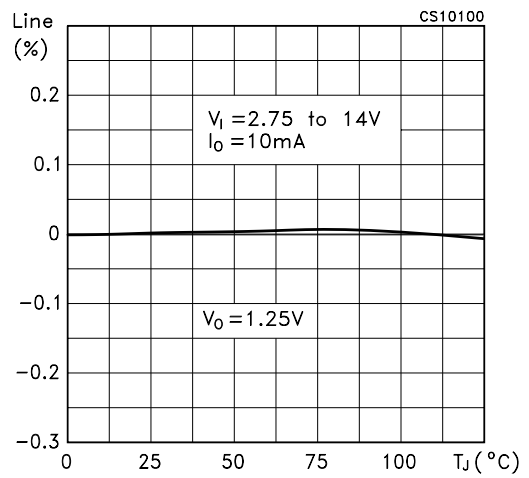

**Figure 2 : Short Circuit Current vs Dropout Voltage**

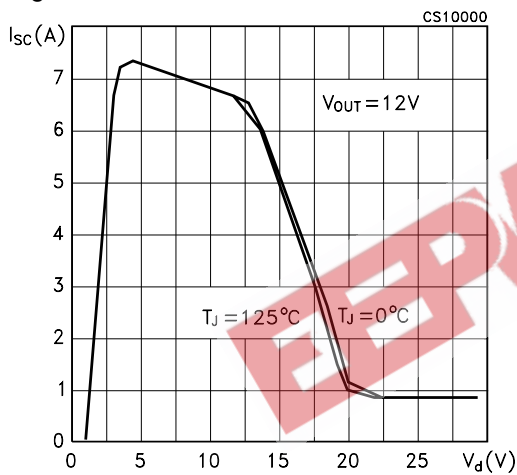

**Figure 5 : Load Regulation vs Temperature**

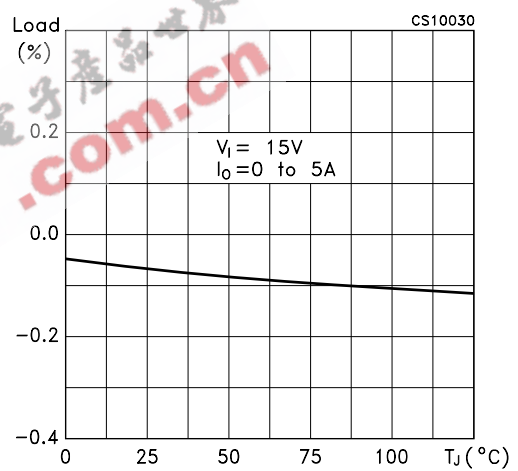

**Figure 3 : Line Regulation vs Temperature**

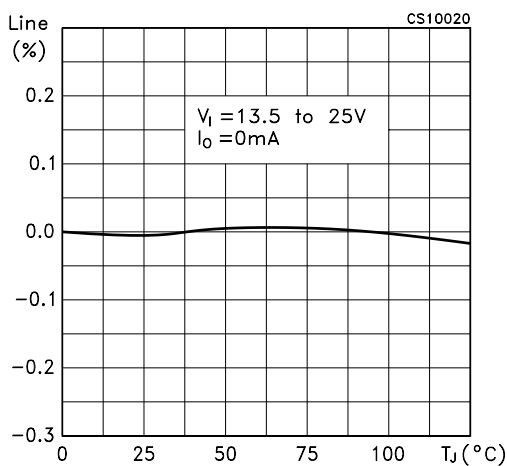

**Figure 6 : Load Regulation vs Temperature**

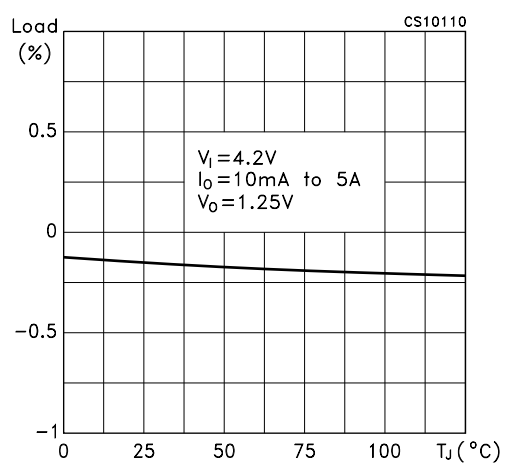

Figure 7 : Dropout Voltage vs Temperature

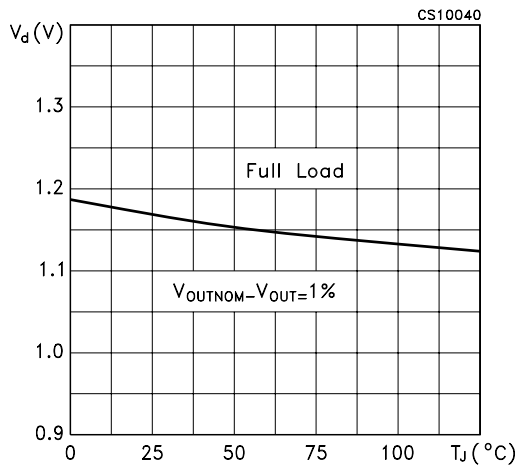

Figure 10 : Adjust Pin Current vs Temperature

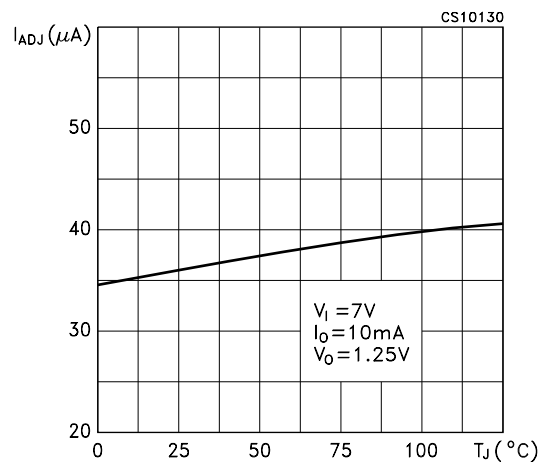

Figure 8 : Dropout Voltage vs Output Current

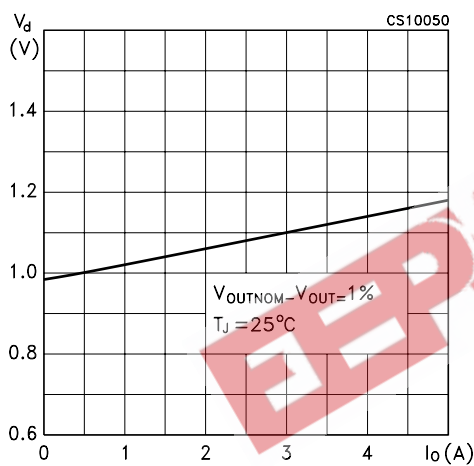

Figure 11 : Adjust Pin Current Change vs Temperature

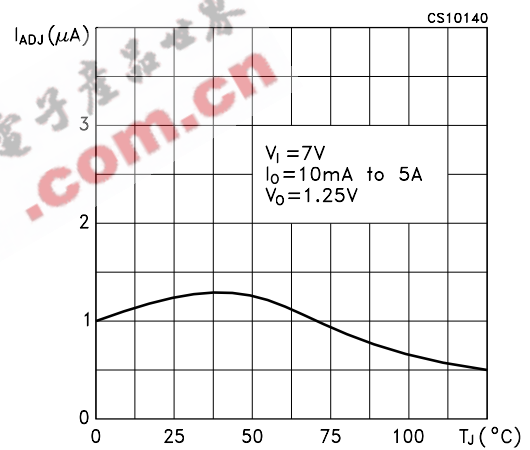

Figure 9 : Adjust Pin Current vs Input Voltage

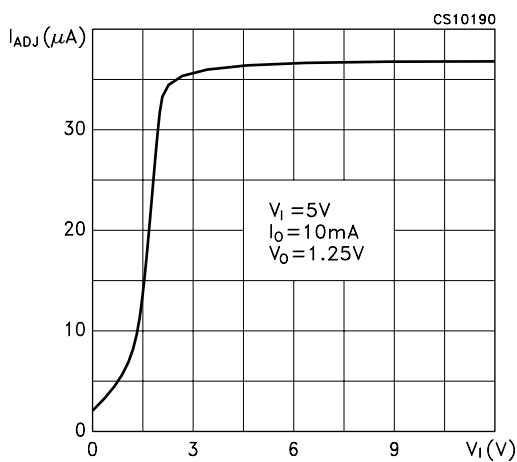

Figure 12 : Quiescent Current vs Temperature

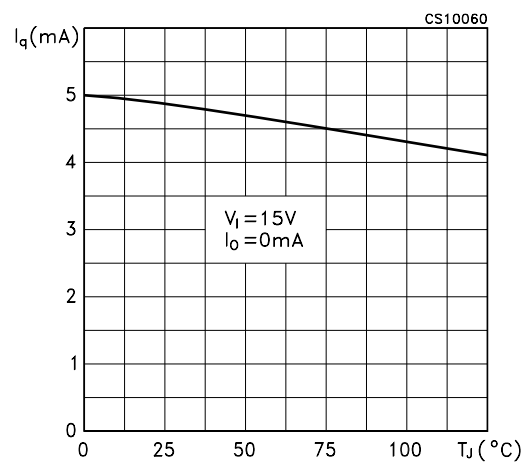

Figure 13 : Reference Voltage vs Temperature

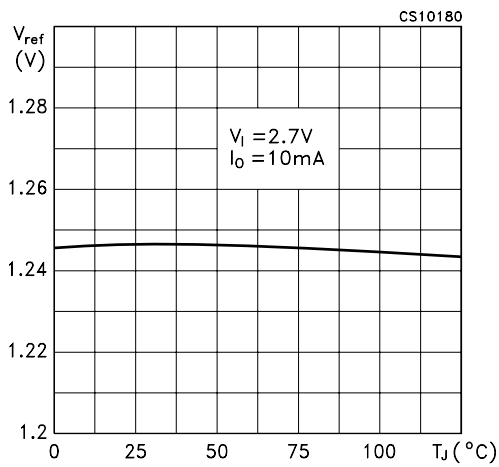

Figure 16 : Supply Voltage Rejection vs Output Current

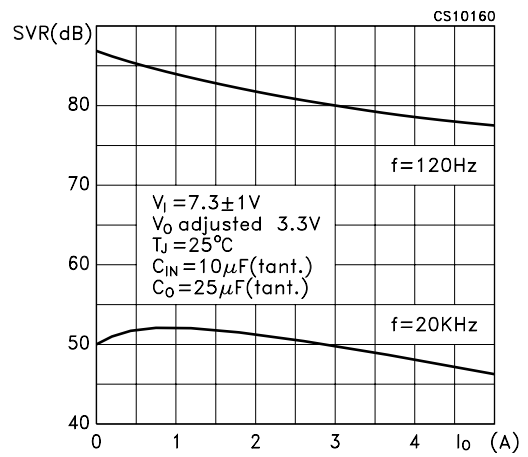

Figure 14 : Minimum Load Current vs Temperature

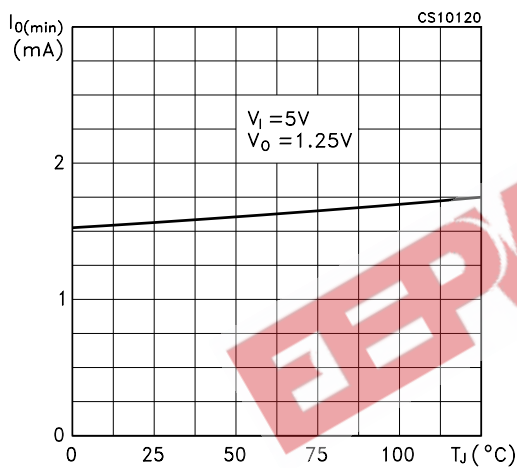

Figure 17 : Supply Voltage Rejection vs Frequency

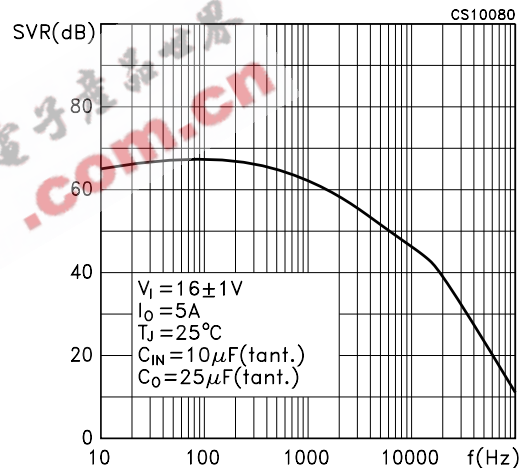

Figure 15 : Supply Voltage Rejection vs Output Current

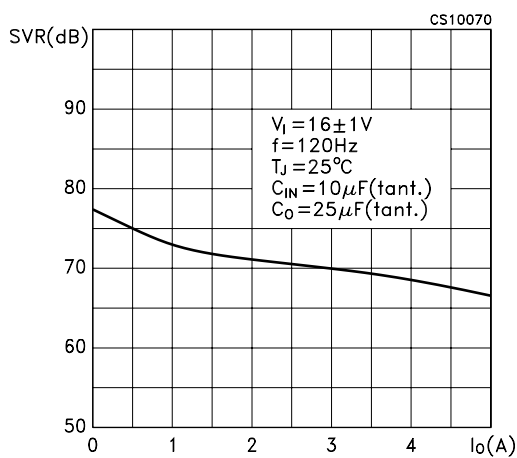

Figure 18 : Supply Voltage Rejection vs Frequency

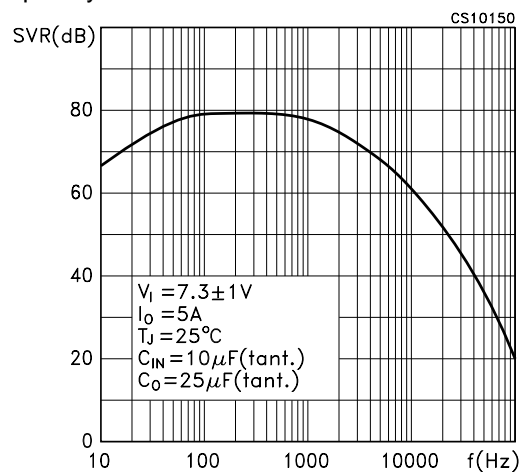

Figure 19 : Supply Voltage Rejection vs Temperature

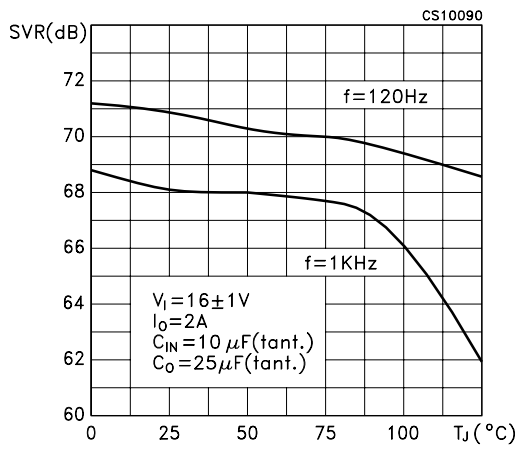

Figure 22 : Load Transient

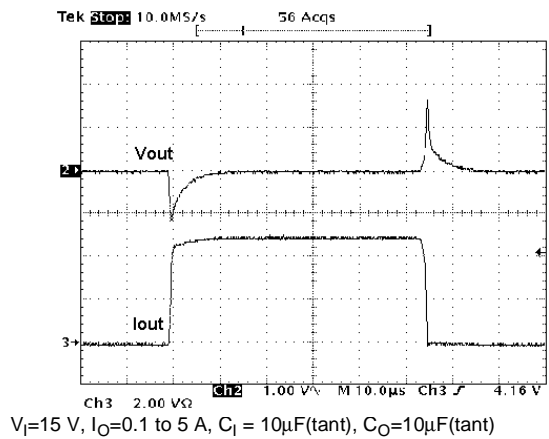

Figure 20 : Supply Voltage Rejection vs Temperature

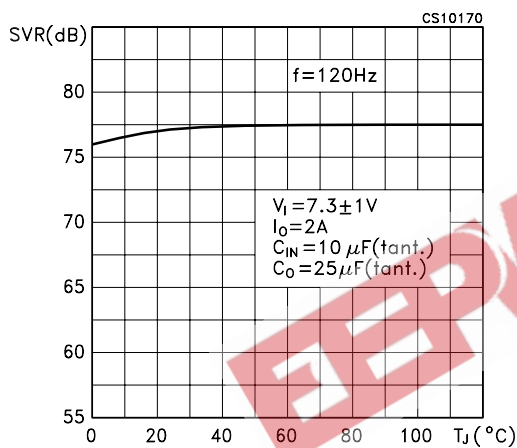

Figure 23 : Load Transient

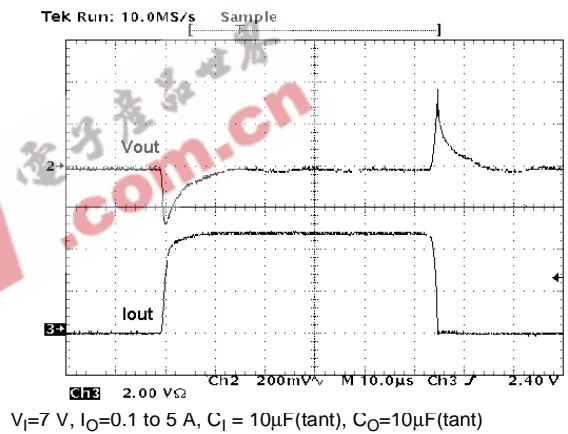
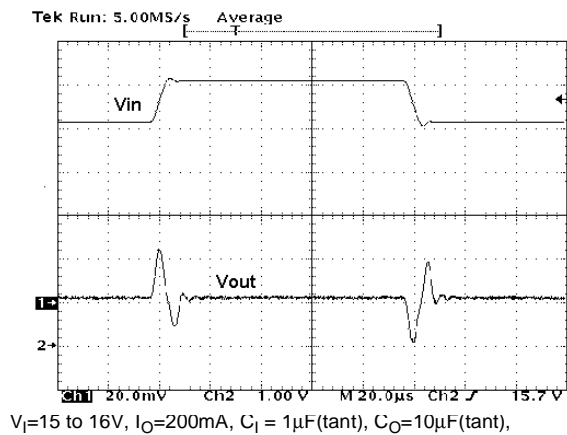
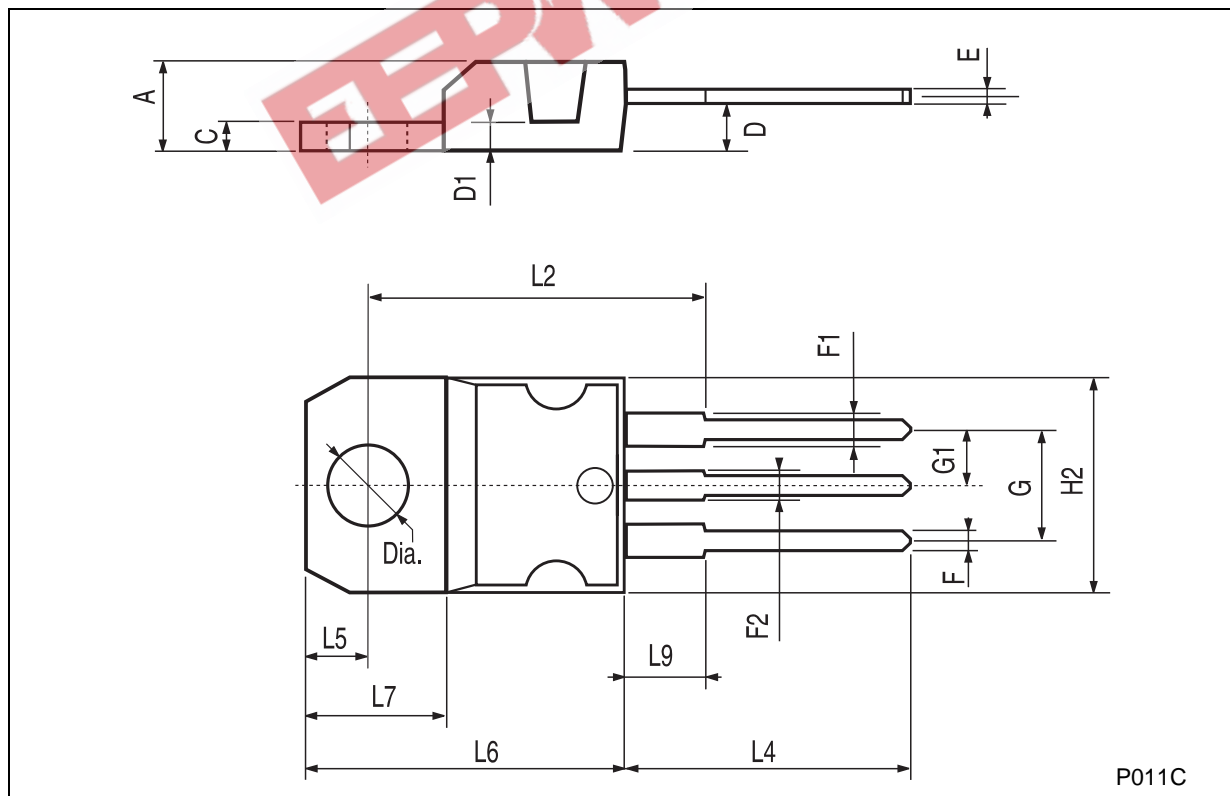

Figure 21 : Line Transient



## TO-220 MECHANICAL DATA

DIM.	mm.			inch		
	MIN.	TYP.	MAX.	MIN.	TYP.	MAX.
A	4.40		4.60	0.173		0.181
C	1.23		1.32	0.048		0.051
D	2.40		2.72	0.094		0.107
D1		1.27			0.050	
E	0.49		0.70	0.019		0.027
F	0.61		0.88	0.024		0.034
F1	1.14		1.70	0.044		0.067
F2	1.14		1.70	0.044		0.067
G	4.95		5.15	0.194		0.203
G1	2.4		2.7	0.094		0.106
H2	10.0		10.40	0.393		0.409
L2		16.4			0.645	
L4	13.0		14.0	0.511		0.551
L5	2.65		2.95	0.104		0.116
L6	15.25		15.75	0.600		0.620
L7	6.2		6.6	0.244		0.260
L9	3.5		3.93	0.137		0.154
DIA.	3.75		3.85	0.147		0.151



D<sup>2</sup>PAK MECHANICAL DATA

DIM.	mm.			inch		
	MIN.	TYP	MAX.	MIN.	TYP.	MAX.
A	4.4		4.6	0.173		0.181
A1	2.49		2.69	0.098		0.106
A2	0.03		0.23	0.001		0.009
B	0.7		0.93	0.027		0.036
B2	1.14		1.7	0.044		0.067
C	0.45		0.6	0.017		0.023
C2	1.23		1.36	0.048		0.053
D	8.95		9.35	0.352		0.368
D1		8			0.315	
E	10		10.4	0.393		0.409
E1		8.5			0.335	
G	4.88		5.28	0.192		0.208
L	15		15.85	0.590		0.624
L2	1.27		1.4	0.050		0.055
L3	1.4		1.75	0.055		0.068
M	2.4		3.2	0.094		0.126
R		0.4			0.016	
V2	0°		8°	0°		8°

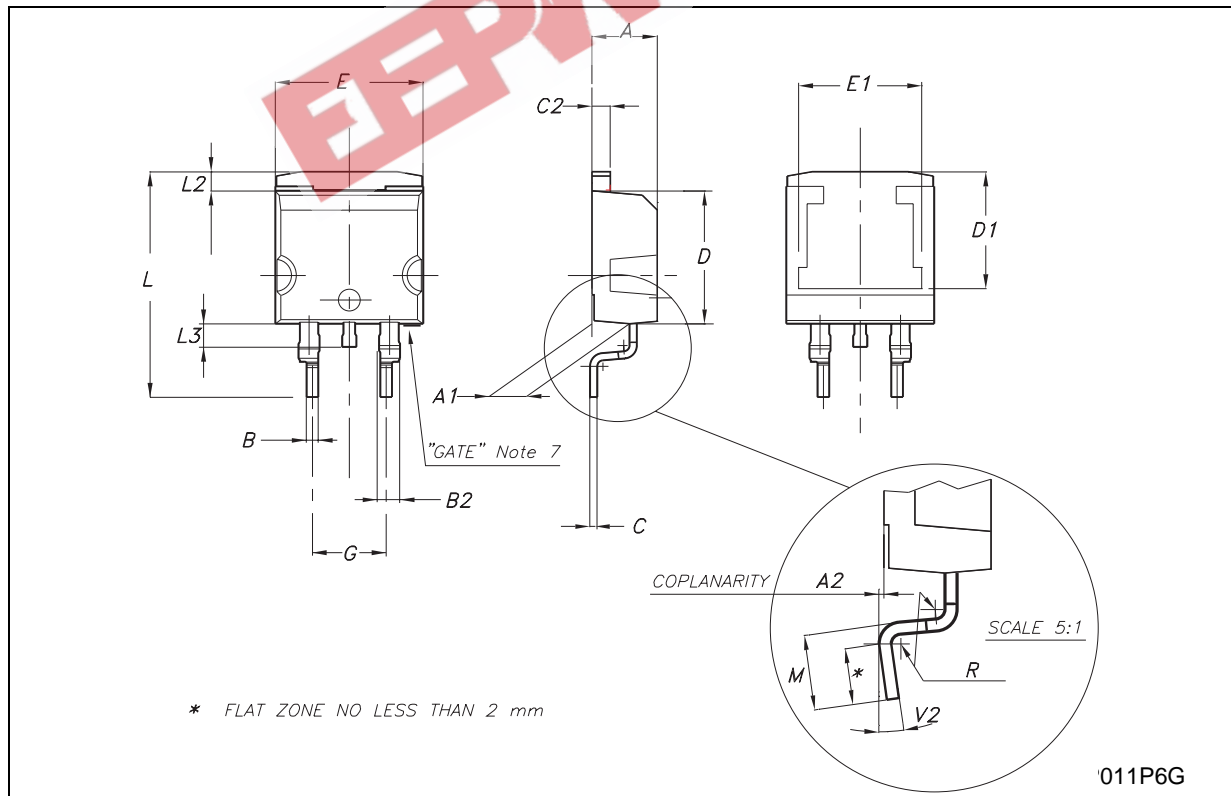

D<sup>2</sup>PAK/A MECHANICAL DATA

DIM.	mm.			inch		
	MIN.	TYP.	MAX.	MIN.	TYP.	MAX.
A	4.40		4.60	0.173		0.181
A1	2.49		2.69	0.098		0.106
B	0.7		0.93	0.027		0.036
B2	1.14		1.7	0.044		0.067
C	0.45		0.60	0.017		0.023
C2	1.21		1.36	0.047		0.053
D	8.95		9.35	0.352		0.368
E	10		10.4	0.393		0.409
G	4.88		5.28	0.192		0.208
L	15		15.85	0.590		0.106
L2	1.27		1.4	0.050		0.055

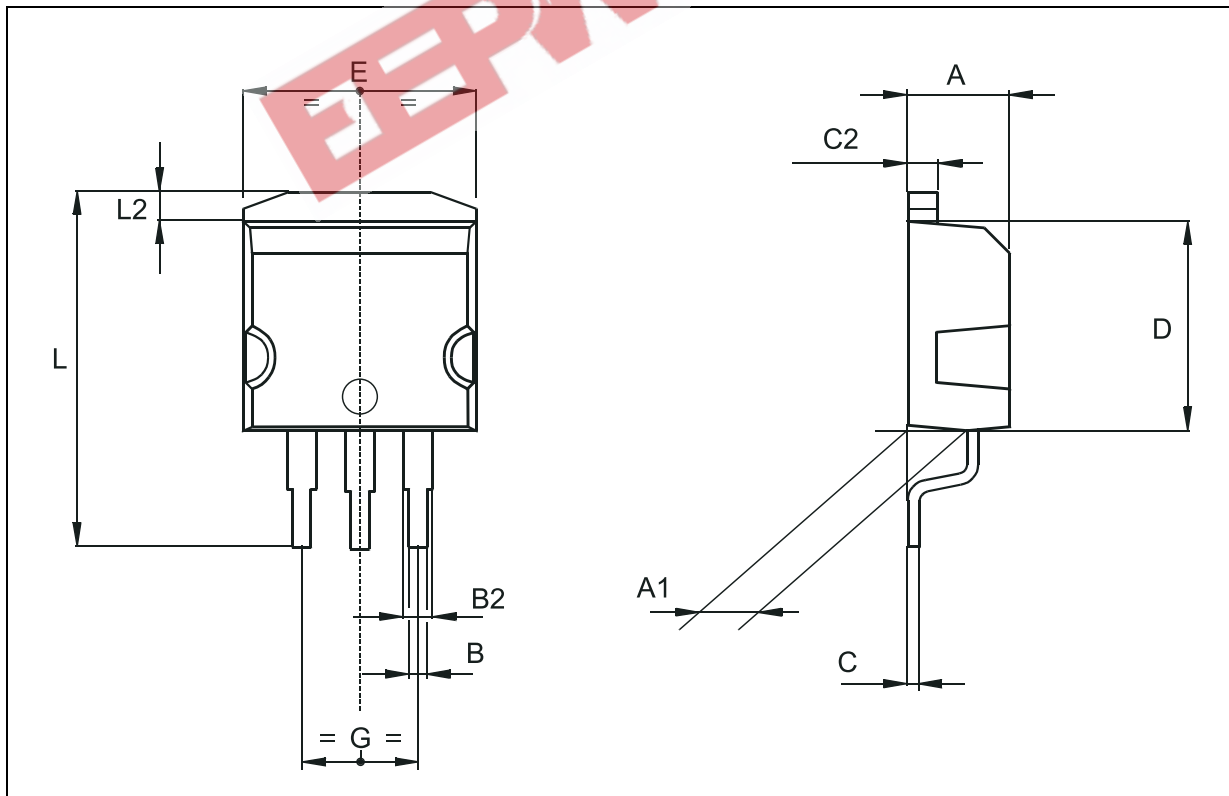

**Tape & Reel D<sup>2</sup>PAK-P<sup>2</sup>PAK-D<sup>2</sup>PAK/A-P<sup>2</sup>PAK/A MECHANICAL DATA**

DIM.	mm.			inch		
	MIN.	TYP	MAX.	MIN.	TYP.	MAX.
A			180			7.086
C	12.8	13.0	13.2	0.504	0.512	0.519
D	20.2			0.795		
N	60			2.362		
T			14.4			0.567
Ao	10.50	10.6	10.70	0.413	0.417	0.421
Bo	15.70	15.80	15.90	0.618	0.622	0.626
Ko	4.80	4.90	5.00	0.189	0.193	0.197
Po	3.9	4.0	4.1	0.153	0.157	0.161
P	11.9	12.0	12.1	0.468	0.472	0.476

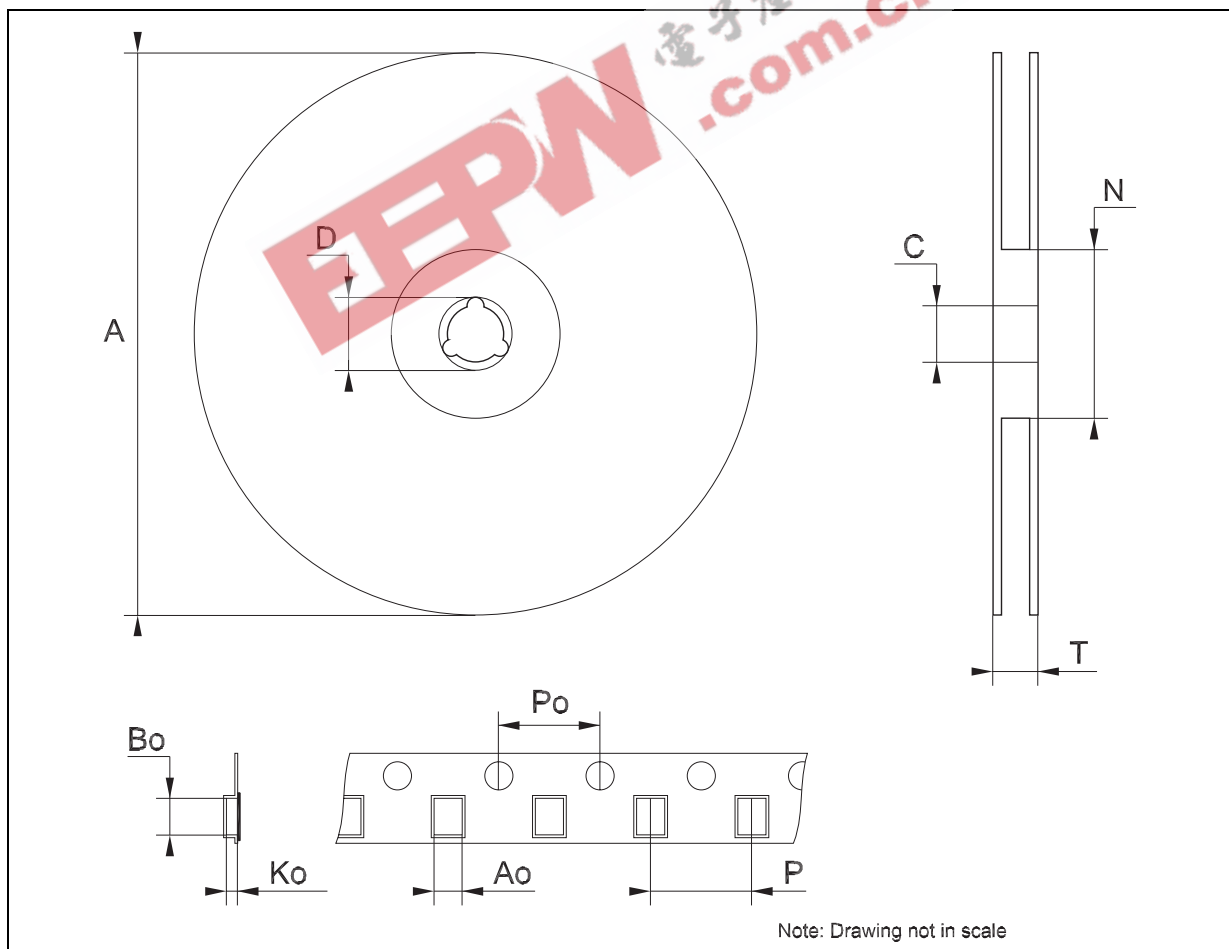



EEPW 电子产品世界  
.com.cn

Information furnished is believed to be accurate and reliable. However, STMicroelectronics assumes no responsibility for the consequences of use of such information nor for any infringement of patents or other rights of third parties which may result from its use. No license is granted by implication or otherwise under any patent or patent rights of STMicroelectronics. Specifications mentioned in this publication are subject to change without notice. This publication supersedes and replaces all information previously supplied. STMicroelectronics products are not authorized for use as critical components in life support devices or systems without express written approval of STMicroelectronics.

The ST logo is a registered trademark of STMicroelectronics  
All other names are the property of their respective owners

© 2003 STMicroelectronics - All Rights Reserved  
STMicroelectronics GROUP OF COMPANIES

Australia - Belgium - Brazil - Canada - China - Czech Republic - Finland - France - Germany - Hong Kong - India - Israel - Italy - Japan -  
Malaysia - Malta - Morocco - Singapore - Spain - Sweden - Switzerland - United Kingdom - United States.

<http://www.st.com>