

LM4937 Boomer® Audio Power Amplifier Series

Audio Sub-System with OCL Stereo Headphone Output and RF Suppression

General Description

The LM4937 is an integrated audio sub-system designed for mono voice, stereo music cell phones connecting to base band processors with mono differential analog voice paths. Operating on a 3.3V supply, it combines a mono speaker amplifier delivering 520mW into an 8Ω load, a stereo headphone amplifier delivering 36mW per channel into a 32Ω load, and a mono earpiece amplifier delivering 55mW into a 32Ω load. It integrates the audio amplifiers, volume control, mixer, and power management control all into a single package. In addition, the LM4937 routes and mixes the single-ended stereo and differential mono inputs into multiple distinct output modes. The LM4937 features an I²S serial interface for full range audio and an I²C or SPI compatible interface for control. The full range music path features an SNR of 85dB with an 18-bit 48kHz input.

Boomer audio power amplifiers are designed specifically to provide high quality output power with a minimal amount of external components.

Key Specifications

■ P _{OUT} BTL, 8Ω, 3.3V, 1%	520mW (typ)
■ P _{OUT} H/P, 32Ω, 3.3V, 1%	36mW (typ)
■ P _{OUT} Mono Earpiece, 32Ω, 1%	55mW (typ)
■ Shutdown current	0.6μA (typ)
■ SNR (DAC + Amplifier)	85dB (typ)

Features

- 18-bit stereo DAC
- Multiple distinct output modes
- Mono speaker amplifier
- Stereo headphone amplifier
- Mono earpiece amplifier
- Differential mono analog input
- Independent loudspeaker, headphone and mono earpiece volume controls
- I²C/SPI (selectable) compatible interface
- Ultra low shutdown current
- Click and Pop Suppression circuit

Applications

- Cell Phones
- PDAs

Block Diagram

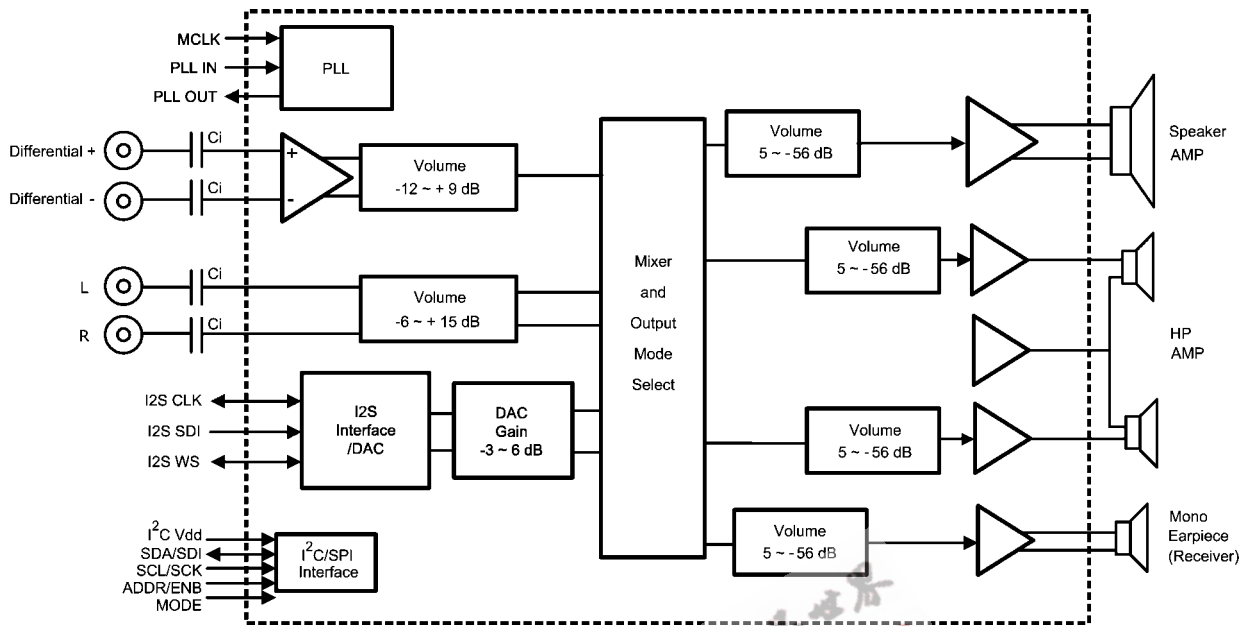

20202001

FIGURE 1. Audio Sub-System Block Diagram with OCL HP Outputs (HP outputs may also be configured as cap-coupled)

Connection Diagrams

36 – Bump Micro SMD

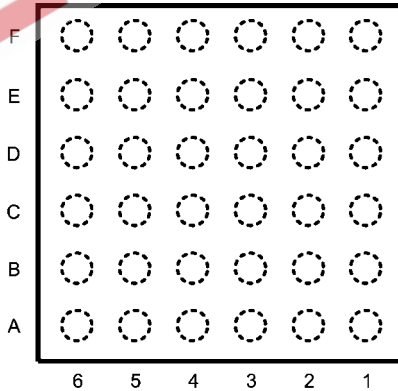

20202058

Top View (Bump Side Down)
Order Number LM4937TL
See NS Package Number TLA36LVA

36 – Bump Micro SMD
Top Marking Drawing

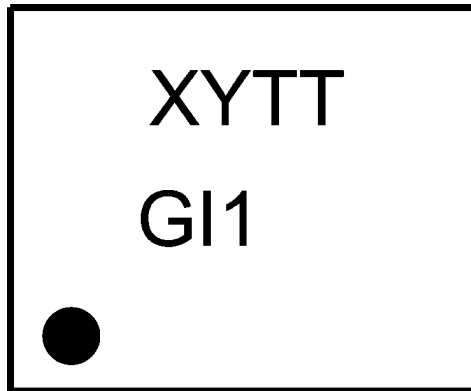

20202002

Top View
XY – 2 Digit Date Code
TT – Die Traceability
G – Boomer Family
11 – LM4937TL

EEPW 电子产品世界
.com.cn

Pin Descriptions

Pin	Pin Name	Digital/ Analog	I/O, Power	Description
A1	DGND	D	P	DIGITAL GND
A2	MCLK	D	I	MASTER CLOCK
A3	I2S_WS	D	I/O	I2S WORD SELECT
A4	SDA/SDI	D	I/O	I2C SDA OR SPI SDI
A5	DVDD	D	P	DIGITAL SUPPLY VOLTAGE
A6	VDD_IO	D	P	I/O SUPPLY VOLTAGE
B1	PLL_VDD	D	P	PLL SUPPLY VOLTAGE
B2	I2S_SDATA	D	I	I2S SERIAL DATA INPUT
B3	I2S_CLK	D	I/O	I2S CLOCK SIGNAL
B4	GPIO	D	O	TEST PIN (MUST BE LEFT FLOATING)
B5	I2C_VDD	D	P	I2C SUPPLY VOLTAGE
B6	SDL/SCK	D	I	I2C_SCL OR SPI_SCK
C1	PLL_GND	D	P	PLL GND
C2	PLL_OUT	D	O	PLL FILTER OUTPUT
C3	PLL_IN	D	I	PLL FILTER INPUT
C4	ADDR/ENB	D	I	I2C ADDRESS OR SPI ENB DEPENDING ON MODE
C5	BYPASS	A	I	HALF-SUPPLY BYPASS
C6	AVDD	A	P	ANALOG SUPPLY VOLTAGE
D1	AGND	A	P	ANALOG GND
D2	AGND	A	P	ANALOG GND
D3	NC			NO CONNECT
D4	MODE	D	I	SELECTS BETWEEN I2C OR SPI CONTROL
D5	RHP	A	O	RIGHT HEADPHONE OUTPUT
D6	CHP	A	O	HEADPHONE CENTER PIN OUTPUT (1/2 VDD or GND)
E1	DIFF_	A	I	ANALOG NEGATIVE DIFFERENTIAL INPUT
E2	LIN	A	I	ANALOG LEFT CHANNEL INPUT
E3	RIN	A	I	ANALOG RIGHT CHANNEL INPUT
E4	NC			NO CONNECT
E5	LHP	A	O	LEFT HEADPHONE OUTPUT
E6	AGND	A	P	ANALOG GND
F1	DIFF+	A	I	ANALOG POSITIVE DIFFERENTIAL INPUT
F2	EP_	A	O	MONO EARPIECE-
F3	EP+	A	O	MONO EARPIECE+
F4	LS-	A	O	LOUDSPEAKER OUT-
F5	AVDD	A	P	ANALOG SUPPLY VOLTAGE
F6	LS+	A	O	LOUD SPEAKER OUT+

Absolute Maximum Ratings (Notes 1, 2)

If Military/Aerospace specified devices are required, please contact the National Semiconductor Sales Office/Distributors for availability and specifications.

Analog Supply Voltage	6.0V
Digital Supply Voltage	6.0V
Storage Temperature	-65°C to +150°C
Input Voltage	-0.3V to $V_{DD} + 0.3V$
Power Dissipation (Note 3)	Internally Limited
ESD Susceptibility (Note 4)	2000V
ESD Susceptibility (Note 5)	200V
Junction Temperature	150°C

Thermal Resistance

 θ_{JA} (TLA36)

100°C/W

See AN-1279

Operating Ratings

Temperature Range

 $T_{MIN} \leq T_A \leq T_{MAX}$ $-40^\circ\text{C} \leq T_A \leq +85^\circ\text{C}$

Supply Voltage

 $2.7V \leq AV_{DD} \leq 5.5V$ $2.7V \leq DV_{DD} \leq 4.0V$ $2.4V \leq I^2CV_{DD} \leq 4.0V$ **Audio Amplifier Electrical Characteristics** $AV_{DD} = 3.0V$, $DV_{DD} = 3.0V$ (Notes 1, 2)

The following specifications apply for the circuit shown in Figure 1 with all programmable gain set at 0dB, unless otherwise specified. Limits apply for $T_A = 25^\circ\text{C}$.

Symbol	Parameter	Conditions	LM4937		Units (Limits)
			Typical (Note 6)	Limits (Notes 7, 8)	
I_{DD}	Supply Current	$V_{IN} = 0$, No Load All Amps On + DAC, OCL (Note 11)	14	19	mA (max)
		Headphone Mode Only, OCL	4.6	6.25	mA (max)
		Mono Loudspeaker Mode Only (Note 11)	7	11.5	mA (max)
		Mono Earpiece Speaker Mode Only D_6 = 0 (register 01h) D_6 = 1	3.7 3.3	5	mA (max) mA
		DAC Off, All Amps On (OCL) (Note 11)	10	15.5	mA (max)
I_{SD}	Shutdown Current		0.6	2	μA (max)
P_O	Output Power	Speaker; THD = 1%; f = 1kHz, 8 Ω BTL	420	370	mW (min)
		Headphone; THD = 1%; f = 1kHz, 32 Ω SE	27	24	mW (min)
		Earpiece; THD = 1%; f = 1kHz, 32 Ω BTL	45	40	mW (min)
$V_{FS\text{DAC}}$	Full Scale DAC Output		2.4		Vpp
THD+N	Total Harmonic Distortion	Speaker; $P_O = 200\text{mW}$; f = 1kHz, 8 Ω BTL	0.04		%
		Headphone; $P_O = 10\text{mW}$; f = 1kHz, 32 Ω SE	0.01		%
		Earpiece; $P_O = 20\text{mW}$; f = 1kHz, 32 Ω BTL	0.04		%
V_{OS}	Offset Voltage	Speaker	10	55	mV (max)
		Earpiece	8	50	mV (max)
		Headphone (OCL)	8	40	mV (max)
ϵ_O	Output Noise	A = weighted; 0dB gain; See Table 1	Table 1		
PSRR	Power Supply Rejection Ratio	f = 217Hz; $V_{\text{ripple}} = 200\text{mV}_{P-P}$ $C_B = 2.2\mu\text{F}$; See Table 2	Table 2		
Xtalk	Crosstalk	Headphone; $P_O = 10\text{mW}$ f = 1kHz; OCL	-60		dB
T_{WU}	Wake-Up Time	$C_B = 2.2\mu\text{F}$, CD6 = 0	35		ms (max)
		$C_B = 2.2\mu\text{F}$, CD6 = 1	85		ms (max)
CMRR	Common-Mode Rejection Ratio	f = 217Hz, $V_{RMS} = 200\text{mVpp}$	56		dB

Audio Amplifier Electrical Characteristics $V_{DD} = 5.0V$, $DV_{DD} = 3.3V$ (Notes 1, 2)

The following specifications apply for the circuit shown in Figure 1 with all programmable gain set at 0dB, unless otherwise specified. Limits apply for $T_A = 25^\circ C$.

Symbol	Parameter	Conditions	LM4937		Units (Limits)
			Typical (Note 6)	Limits (Notes 7, 8)	
I_{DD}	Supply Current	$V_{IN} = 0$, No Load All Amps On + DAC, OCL (Note 11)	17.5		mA (max)
		Headphone Mode Only (OCL)	5.8		mA (max)
		Mono Loudspeaker Mode Only (Note 11)	11.6		mA (max)
		Mono Earpiece Mode Only (Note 11)	5		mA (max)
		DAC Off, All Amps On (OCL) (Note 11)	12.9		mA (max)
I_{SD}	Shutdown Current		1.6		μA (max)
P_O	Output Power	Speaker; THD = 1%; $f = 1kHz$, 8Ω BTL	1.25		mW (min)
		Headphone; THD = 1%; $f = 1kHz$, 32Ω SE	80		mW (min)
		Earpiece; THD = 1%; $f = 1kHz$, 32Ω BTL	175		mW (min)
$V_{FS\ DAC}$	Full Scale DAC Output		2.4		V _{pp}
THD+N	Total Harmonic Distortion	Speaker; $P_O = 500mW$; $f = 1kHz$, 8Ω BTL	0.03		%
		Headphone; $P_O = 30mW$; $f = 1kHz$, 32Ω SE	0.01		%
		Earpiece; $P_O = 40mW$; $f = 1kHz$, 32Ω BTL; CD4 = 0	0.04		%
V_{OS}	Offset Voltage	Speaker	10		mV
		Earpiece	8		mV
		HP (OCL)	8		mV
ϵ_O	Output Noise	A = weighted; 0dB gain; See Table 1	Table 1		
PSRR	Power Supply Rejection Ratio	$f = 217Hz$; $V_{ripple} = 200mV_{P-P}$ $C_B = 2.2\mu F$; See Table 3	Table 3		
Xtalk	Crosstalk	Headphone; $P_O = 15mW$ $f = 1kHz$; OCL	-56		dB
T_{WU}	Wake-Up Time	$C_B = 2.2\mu F$, CD6 = 0	45		ms
		$C_B = 2.2\mu F$, CD6 = 1	130		ms

Volume Control Electrical Characteristics (Notes 1, 2)

The following specifications apply for $3V \leq AV_{DD} \leq 5V$ and $2.7V \leq DV_{DD} \leq 4.0V$, unless otherwise specified. Limits apply for $T_A = 25^\circ C$.

Symbol	Parameter	Conditions	LM4937		Units (Limits)
			Typical (Note 6)	Limits (Notes 7, 8)	
PGR	Stereo Analog Inputs PreAmp Gain Setting Range	minimum gain setting	-6	-7 -5	dB (min) dB (max)
		maximum gain setting	15	15.5 14.5	dB (max) dB (min)
	Differential Mono Analog Input PreAmp Gain Setting Range	minimum gain setting	-12	-13 -11	dB (min) dB (max)
		maximum gain setting	9	9.5 8.5	dB (max) dB (min)
VCR	Output Volume Control for Loudspeaker, Headphone Output, or Earpiece Output	minimum gain setting	-56	-59 -53	dB (min) dB (max)
		maximum gain setting	+5	4.5 5.5	dB (min) dB (max)
ΔA_{CH-CH}	Stereo Channel to Channel Gain Mismatch		0.3		dB
A_{MUTE}	Mute Attenuation	$V_{in} = 1V_{rms}$, Gain = 0dB with load			
		Headphone	<-90		dB (min)
R_{INPUT}	DIFF+, DIFF-, L_{IN} and R_{IN} Input Impedance		23	18 28	k Ω (min) k Ω (max)

Digital Section Electrical Characteristics (Notes 1, 2)

The following specifications apply for $3V \leq AV_{DD} \leq 5V$ and $2.7V \leq DV_{DD} \leq 4.0V$, unless otherwise specified. Limits apply for $T_A = 25^\circ C$.

Symbol	Parameter	Conditions	LM4937		Units (Limits)
			Typical (Note 6)	Limits (Notes 7, 8)	
DI_{SD}	Digital Shutdown Current	Mode 0, $DV_{DD} = 3.0V$			
		No MCLK	0.01		μA
DI_{DD}	Digital Power Supply Current	$f_{MCLK} = 12MHz$, $DV_{DD} = 3.0V$ ALL MODES EXCEPT 0	5.3	6.5	mA (max)
$PLLI_{DD}$	PLL Quiescent Current	$f_{MCLK} = 12MHz$, $DV_{DD} = 3.0V$	4.8	6	mA (max)

Audio DAC (Typical numbers are with 6.144MHz audio clock and 48kHz sampling frequency)

R_{DAC}	Audio DAC Ripple	20Hz - 20kHz through headphone output	+/-0.1		dB
PB_{DAC}	Audio DAC Passband width	-3dB point	22.6		kHz
SBA_{DAC}	Audio DAC Stop band Attenuation	Above 24kHz	76		dB
DR_{DAC}	Audio DAC Dynamic Range	DC - 20kHz, -60dBFS; AES17 Standard See Table 4	Table 4		dB
SNR	Audio DAC-AMP Signal to Noise Ratio	A-Weighted, Signal = V_O at 0dBFS, $f = 1kHz$ Noise = digital zero, A-weighted, See Table 4	Table 4		dB
SNR_{DAC}	Internal DAC SNR	A-weighted (Note 10)	95		dB

PLL

f_{IN}	Input Frequency on MCLK pin		12	10 26	MHz

Symbol	Parameter	Conditions	LM4937		Units (Limits)	
			Typical (Note 6)	Limits (Notes 7, 8)		
SPI/I²C						
f _{SPI}	Maximum SPI Frequency			4000	kHz (max)	
t _{SPISETD}	SPI Data Setup Time			100	ns (max)	
t _{SPISETENB}	SPI ENB Setup Time			100	ns (max)	
t _{SPIHOLDD}	SPI Data Hold Time			100	ns (max)	
t _{SPIHOLDENB}	SPI ENB Hold Time			100	ns (max)	
t _{SPICL}	SPI Clock Low Time			125	ns (max)	
t _{SPICH}	SPI Clock High Time			125	ns (max)	
f _{CLKI²C}	I ² C_CLK Frequency			400	kHz (max)	
t _{I²C} HOLD	I ² C_DATA Hold Time			100	ns (max)	
t _{I²C} SET	I ² C_DATA Setup Time			100	ns (max)	
V _{IH}	I ² C/SPI Input High Voltage		I ² CV _{DD}	0.7 x I ² CV _{DD}	V (min)	
V _{IL}	I ² C/SPI Input Low Voltage		0	0.3 x I ² CV _{DD}	V (max)	
I²S						
f _{CLKI²S}	I ² S_CLK Frequency	I ² S_RES = 0		1536	6144	kHz (max)
		I ² S_RES = 1		3072	12288	
	I ² S_WS Duty Cycle			50	40 60	%
V _{IH}	Digital Input High Voltage				0.7 x DV _{DD}	V (min)
V _{IL}	Digital Input Low Voltage				0.3 x DV _{DD}	V (max)

Note 1: All voltages are measured with respect to the GND pin unless otherwise specified.

Note 2: Absolute Maximum Ratings indicate limits beyond which damage to the device may occur. Operating Ratings indicate conditions for which the device is functional but do not guarantee specific performance limits. Electrical Characteristics state DC and AC electrical specifications under particular test conditions which guarantee specific performance limits. This assumes that the device is within the Operating Ratings. Specifications are not guaranteed for parameters where no limit is given, however, the typical value is a good indication of device performance.

Note 3: The maximum power dissipation must be derated at elevated temperatures and is dictated by T_{JMAX} , θ_{JA} , and the ambient temperature, T_A . The maximum allowable power dissipation is $P_{DMAX} = (T_{JMAX} - T_A) / \theta_{JA}$ or the number given in Absolute Maximum Ratings, whichever is lower. For the LM4937 typical application with $V_{DD} = 3.3V$, $R_L = 8\Omega$ stereo operation, the total power dissipation is TBDW. $\theta_{JA} = TBD^\circ C/W$.

Note 4: Human body model: 100pF discharged through a 1.5k Ω resistor.

Note 5: Machine model: 220pF - 240pF discharged through all pins.

Note 6: Typicals are measured at 25°C and represent the parametric norm.

Note 7: Limits are guaranteed to National's AOQL (Average Outgoing Quality Level).

Note 8: Datasheet min/max specification limits are guaranteed by design, test, or statistical analysis.

Note 9: Shutdown current is measured in a normal room environment.

Note 10: Internal DAC only with DAC modes 00 and 01.

Note 11: Enabling mono bit (D_6 in Output Control Register 01h) will save 400 μA (typ) from specified current.

TABLE 1. Output Noise

Output Noise $AV_{DD} = 5V$ and $AV_{DD} = 3V$. All gains set to 0dB. Units in μV . A - weighted

MODE	EP	LS	HP OCL	Units
1	22	22	8	μV
2	22	22	8	μV
3	22	22	8	μV
4	68	88	46	μV
5	38	48	24	μV
6	29	34	18	μV
7	38	48	24	μV

TABLE 2. PSRR $AV_{DD} = 3V$ PSRR $AV_{DD} = 3V$. $f = 217Hz$; $V_{ripple} = 200mVp-p$; $C_B = 2.2\mu F$.

MODE	EP(Typ)	LS (Typ)	LS (Limit)	HP (Typ)	HP (Limit)	Units
1	69	76		72		dB
2	69	76	67	72	68	dB
3	69	76		72		dB
4	63	62		55		dB
5	69	68		61		dB
6	69	70		64		dB
7	69	68		61		dB

TABLE 3. PSRR $AV_{DD} = 5V$ PSRR $AV_{DD} = 5V$. All gains set to 0dB. $f = 217Hz$; $V_{ripple} = 200mVp-p$; $C_B = 2.2\mu F$

MODE	EP (Typ)	LS (Typ)	HP (Typ)	Units
1	68	72	71	dB
2	68	72	71	dB
3	68	72	71	dB
4	68	66	69	dB
5	68	69	70	dB
6	69	72	71	dB
7	68	69	70	dB

TABLE 4. Dynamic Range and SNR

Dynamic Range and SNR. $3V \leq AV_{DD} \leq 5V$. All programmable gain set to 0dB. Units in dB.

	DR (Typ)	SNR (Typ)	Units
LS	95	85	dB
HP	95	85	dB
EP	97	85	dB

System Control

The LM4937 is controlled via either a two wire I²C compatible interface or three wire SPI interface, selectable with the MODE pin. This interface is used to configure the operating mode, interfaces, data converters, mixers and amplifiers. The LM4937 is controlled by writing 8 bit data into a series of write-only registers, the device is always a slave for both type of interfaces.

THREE WIRE, SPI INTERFACE (MODE = 1)

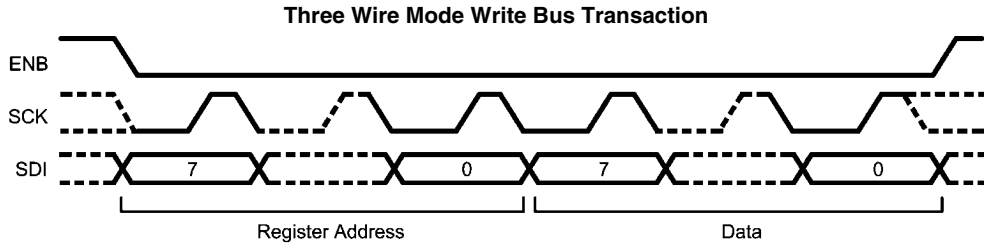

20202059

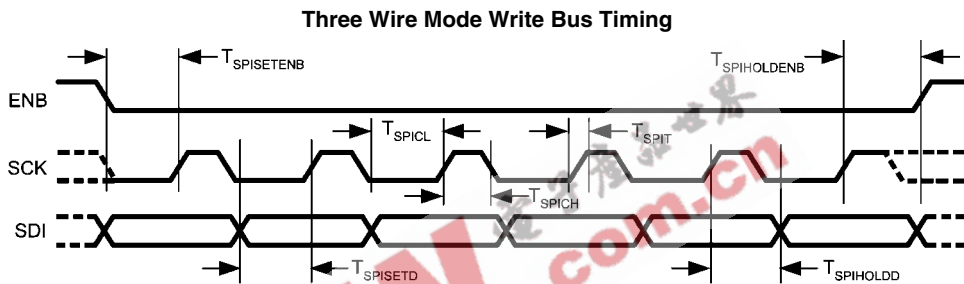

20202060

FIGURE 2. Three Wire Mode Write Bus

When the part is configured as an SPI device and the enable (ENB) line is lowered the serial data on SDI is clocked in on the rising edge of the SCK line. The protocol used is 16bit, MSB first. The upper 8 bits (15:8) are used to select an address within the device, the lower 8 bits (7:0) contain the updated data for this register.

TWO WIRE I²C COMPATIBLE INTERFACE (MODE = 0)

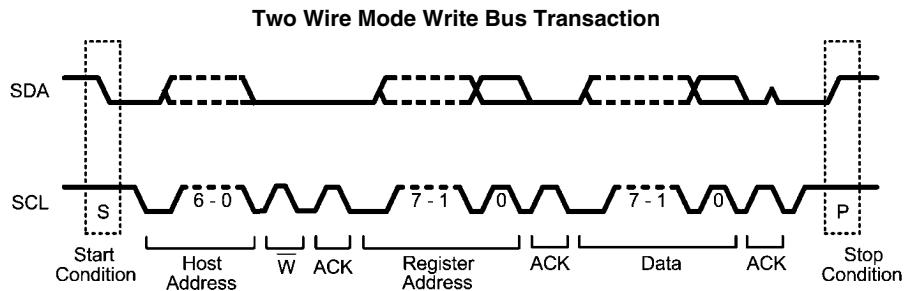

202020j6

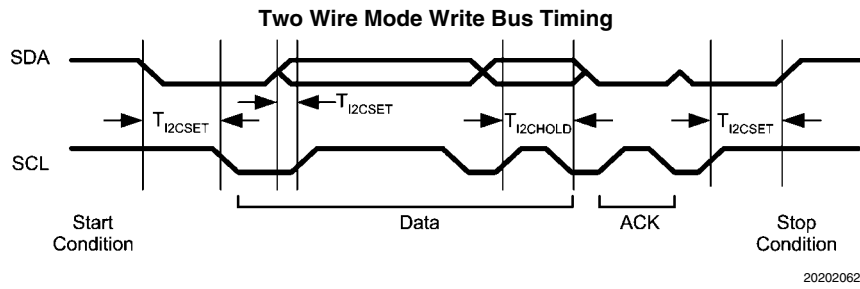

FIGURE 3. Two Wire Mode Write Bus

When the part is configured as an I²C device then the LM4937 will respond to one of two addresses, according to the ADDR input. If ADDR is low then the address portion of the I²C transaction should be set to write to 0010000. When ADDR is high then the address input should be set to write to 1110000.

TABLE 5. Chip Address

	A7	A6	A5	A4	A3	A2	A1	A0
Chip Address	0	EC	EC	1	0	0	0	0
ADR = 0	0	0	0	1	0	0	0	0
ADR = 1	0	1	1	1	0	0	0	0

EC — Externally configured by ADDR pin

TABLE 6. Control Registers

Address	Register	D7	D6	D5	D4	D3	D2	D1	D0
00h	Mode Control	0	CD_6	0	OCL	CD_3	CD_2	CD_1	CD_0
01h	Output Control	0	D_6	0	0	HP_R_ OUTPUT	HP_L_ OUTPUT	LS_ OUTPUT	MONO_ OUTPUT
02h	Mono Volume Control	0	0	0	EP_VOL_4	EP_VOL_3	EP_VOL_2	EP_VOL_1	EP_VOL_0
03h	Loud Speaker Volume Control	0	0	0	LS_VOL_4	LS_VOL_3	LS_VOL_2	LS_VOL_1	LS_VOL_0
04h	RESERVED	0	0	0	0	0	0	0	0
05h	Headphone Left Volume Control	0	0	0	HP_L_VOL_4	HP_L_VOL_3	HP_L_VOL_2	HP_L_VOL_1	HP_L_VOL_0
06h	Headphone Right Volume Control	0	0	0	HP_R_VOL_4	HP_R_VOL_3	HP_R_VOL_2	HP_R_VOL_1	HP_R_VOL_0
07h	Analog R & L Input Gain Control	0	0	ANA_R_ GAIN_2 ANA_R_ GAIN_1	ANA_R_ GAIN_1	ANA_R_ GAIN_0	ANA_L_ GAIN_2 ANA_L_ GAIN_1	ANA_L_ GAIN_1	ANA_L_ GAIN_0
08h	Analog Mono & DAC Input Gain Control	0	0	DIG_R_ GAIN_0 DIG_L_ GAIN_1	DIG_L_ GAIN_1	DIG_L_ GAIN_0	MONO_IN_ GAIN_2 MONO_IN_ GAIN_1	MONO_IN_ GAIN_1	MONO_IN_ GAIN_0
09h	Clock Configuration	R_DIV_3	R_DIV_2	R_DIV_1	R_DIV_0	PLL_ ENABLE	AUDIO _CLK_SEL	PLL_INPUT	FAST_ CLOCK
0Ah	PLL M Divider	0	PLL_M_6	PLL_M_5	PLL_M_4	PLL_M_3	PLL_M_2	PLL_M_1	PLL_M_0
0Bh	PLL N Divider	PLL_N_7	PLL_N_6	PLL_N_5	PLL_N_4	PLL_N_3	PLL_N_2	PLL_N_1	PLL_N_0
0Ch	PLL N_MOD Divider and Dither Level	VCO_FAST	PLL_DITH_LEV_1	PLL_DITH_LEV_0	PLL_N_MOD_4	PLL_N_MOD_3	PLL_N_MOD_2	PLL_N_MOD_1	PLL_N_MOD_0
0Dh	PLL_P Divider	0	0	0	0	PLL_P_3	PLL_P_2	PLL_P_1	PLL_P_0
0Eh	DAC Setup	0	CUST_COMP	DITHER_ALW_ON	DITHER_OFF	MUTE_R	MUTE_L	DAC_MODE_1	DAC_MODE_0
0Fh	Interface	0	0	0	0	I2C_FAST	I2S_MODE	I2S_RESOL	I2S_M/S
10h	COMPENSATION_C_OEFF0_LSB	COMP0_7	COMP0_6	COMP0_5	COMP0_4	COMP0_3	COMP0_2	COMP0_1	COMP0_0
11h	COMPENSATION_C_OEFF0_MSB	COMP0_15	COMP0_14	COMP0_13	COMP0_12	COMP0_11	COMP0_10	COMP0_9	COMP0_8
12h	COMPENSATION_C_OEFF1_LSB	COMP1_7	COMP1_6	COMP1_5	COMP1_4	COMP1_3	COMP1_2	COMP1_1	COMP1_0
13h	COMPENSATION_C_OEFF1_MSB	COMP1_15	COMP1_14	COMP1_13	COMP1_12	COMP1_11	COMP1_10	COMP1_9	COMP1_8
14h	COMPENSATION_C_OEFF2_LSB	COMP2_7	COMP2_6	COMP2_5	COMP2_4	COMP2_3	COMP2_2	COMP2_1	COMP2_0

Address	Register	D7	D6	D5	D4	D3	D2	D1	D0
15h	COMPENSATION _C_OEFF2_MSB	COMP2_15	COMP2_14	COMP2_13	COMP2_12	COMP2_11	COMP2_10	COMP2_9	COMP2_8
16h	TEST_ REGISTER	RESERVED	RESERVED	RESERVED	RESERVED	RESERVED	RESERVED	RESERVED	RESERVED

Note: All registers default to 0 on initial power-up.

EEPW.com.cn 电子产品世界

System Controls

TABLE 7. Loudspeaker, Earpiece, HP Left or Right Volume Control

EP_VOL_4, LS_VOL_4, HP_L_VOL_4, HP_R_VOL_4	EP_VOL_3, LS_VOL_3, HP_L_VOL_3, HP_R_VOL_3	EP_VOL_2, LS_VOL_2, HP_L_VOL_2, HP_R_VOL_2	EP_VOL_1, LS_VOL_1, HP_L_VOL_1, HP_R_VOL_1	EP_VOL_0, LS_VOL_0, HP_L_VOL_0, HP_R_VOL_0	Gain (dB)
0	0	0	0	0	<-90 (MUTE)
0	0	0	0	1	-56
0	0	0	1	0	-52
0	0	0	1	1	-48
0	0	1	0	0	-45
0	0	1	0	1	-42
0	0	1	1	0	-39
0	0	1	1	1	-36
0	1	0	0	0	-33
0	1	0	0	1	-30
0	1	0	1	0	-28
0	1	0	1	1	-26
0	1	1	0	0	-24
0	1	1	0	1	-22
0	1	1	1	0	-20
0	1	1	1	1	-18
1	0	0	0	0	-16
1	0	0	0	1	-14
1	0	0	1	0	-12
1	0	0	1	1	-10
1	0	1	0	0	-8
1	0	1	0	1	-6
1	0	1	1	0	-4
1	0	1	1	1	-3
1	1	0	0	0	-2
1	1	0	0	1	-1
1	1	0	1	0	0
1	1	0	1	1	+1
1	1	1	0	0	+2
1	1	1	0	1	+3
1	1	1	1	0	+4
1	1	1	1	1	+5

TABLE 8. Mixer Code Control

Mode	CD3	CD2	CD1	CD0	Mono Earpiece	Loudspeaker	Headphone L	Headphone R
0	0	0	0	0	SD	SD	SD	SD
1	1	0	0	1	M	M	M	M
2	1	0	1	0	AL+AR	AL+AR	AL	AR
3	1	0	1	1	M+AL+AR	M+AL+AR	M+AL	M+AR
4	1	1	0	0	DL+DR	DL+DR	DL	DR
5	1	1	0	1	DL+DR+ AL+AR	DL+AL AL+AR	DL+AL	DR+AR
6	1	1	1	0	M+DL+AL+ DR+AR	M+DL+AL+ DR+AR	M+DL+AL	M+DR+AR
7	1	1	1	1	M+DL+DR	M+DL+DR	M+DL	M+DR

SD — Shutdown

M — Mono Differential Input

AL — Analog Left Channel

AR — Analog Right Channel

DL — I2S DAC Left Channel

DR — I2S DAC Right Channel

MUTE — Mute

Note: Power-On Default Mode is Mode 0

EEPW 电子产品世界
.com.cn

TABLE 9. Output Control (01h)

Loudspeaker	LS_OUTPUT = 1		LS_OUTPUT = 0	
	Output On		Output Off	
Headphone Left Channel	HP_L_OUTPUT = 1		HP_L_OUTPUT = 0	
	Output On		Output Off (OCL = 0)	Output Mute (OCL = 1)
Headphone Right Channel	HP_R_OUTPUT = 1		HP_R_OUTPUT = 0	
	Output On		Output Off (OCL = 0)	Output Mute (OCL = 1)
Earpiece	EP_OUTPUT = 1		EP_OUTPUT = 0	
	Output On		Output Off	
All Outputs	CD3 = 1		CD3 = 0	
	Outputs Toggled Via Register Control		All Outputs Off	

TABLE 10. Mono Differential Amplifier Input Gain Select (08h)

MONO_IN_GAIN_2	MONO_IN_GAIN_1	MONO_IN_GAIN_0	Input Gain Setting
0	0	0	-12dB
0	0	1	-9dB
0	1	0	-6dB
0	1	1	-3dB
1	0	0	0dB
1	0	1	3dB
1	1	0	6dB
1	1	1	9dB

TABLE 11. Analog Single-Ended Input Amplifier Gain Select (07h)

ANA_L_GAIN_2 ANA_R_GAIN_2	ANA_L_GAIN_1 ANA_R_GAIN_1	ANA_L_GAIN_0 ANA_R_GAIN_0	Input Gain Setting
0	0	0	-6dB
0	0	1	-3dB
0	1	0	0dB
0	1	1	3dB
1	0	0	6dB
1	0	1	9dB
1	1	0	12dB
1	1	1	15dB

TABLE 12. DAC Gain Select (08h)

DIG_L_GAIN_1 DIG_R_GAIN_1	DIG_L_GAIN_0 DIG_R_GAIN_0	Input Gain Setting
0	0	-3dB
0	1	0dB
1	0	3dB
1	1	6dB

PLL Configuration Registers

PLL M DIVIDER CONFIGURATION REGISTER

This register is used to control the input divider of the PLL.

PLL_M (0Ah) (Set = logic 1, Clear = logic 0)

Bits	Register	Description	
6:0	PLL_M	Programs the PLL input divider to select:	
		PLL_M	Divide Ratio
		0	Divider Off
		1	1
		2	1.5
		3	2
		4	2.5
		...	3→
		126	63.5

NOTES:

The M divider should be set such that the output of the divider is between 0.5 and 5MHz. See the PLL setup section for details.

The division of the M divider is derived from PLL_M as such:

$$M = (PLL_M + 1) / 2$$

PLL N DIVIDER CONFIGURATION REGISTER

This register is used to control PLL N divider.

PLL_N (0Bh) (Set = logic 1, Clear = logic 0)

Bits	Register	Description	
7:0	PLL_N	Programs the PLL feedback divider:	
		PLL_N	Divide Ratio
		0	Divider Off
		1 → 10	10
		11	11
		12	12
	
		248	248
		249	249

NOTES:

The N divider should be set such that the output of the divider is between 0.5 and 5MHz. See the PLL setup section for details. The N divider should never be set so that $(F_{in}/M) * N > 55\text{MHz}$ (or 80MHz if FAST_VCO is set in the PLL_N_MOD register).

The non-sigma-delta division of the N divider is derived from the PLL_N as such:

$$N = PLL_N$$

F_{in}/M is often referred to as F_{comp} (Frequency of Comparison) or F_{ref} (Reference Frequency). In this document, F_{comp} is used.

PLL P DIVIDER CONFIGURATION REGISTER

This register is used to control the PLL's P divider.

PLL_P (0Dh) (Set = logic 1, Clear = logic 0)

Bits	Register	Description	
3:0	PLL_P	Programs the PLL input divider to select:	
		0	Divider Off
		1	1
		2	1.5
		3	2
		...	-> 2.5
		13	7
		14	7.5
		15	8

NOTES:

The output of this divider should be either 12 or 24MHz in USB mode or 11.2896MHz, 12.288MHz or 24.576MHz in non-USB modes.

The division of the P divider is derived from PLL_P as such:

$$P = (\text{PLL_P} + 1) / 2$$

PLL N MODULATOR AND DITHER SELECT CONFIGURATION REGISTER

This register is used to control the Fractional component of the PLL.

PLL_N_MOD (0Ch) (Set = logic 1, Clear = logic 0)

Bits	Register	Description	
4:0	PLL_N_MOD	This programs the PLL N Modulator's fractional component:	
		PLL_N_MOD	Fractional Addition
		0	0/32
		1	1/32
		2 → 30	2/32 → 30/32
6:5	DITHER_LEVEL	Allows control over the dither used by the N Modulator	
		DITHER_LEVEL	DAC Sub-system Input Source
		00	Medium (32)
		01	Small (16)
7	FAST_VCO	If set the VCO maximum and minimum frequencies are raised:	
		FAST_VCO	Maximum F_{VCO}
		0	40–55MHz

NOTES:

The complete N divider is a fractional divider as such:

$$N = \text{PLL_N} + (\text{PLL_N_MOD}/32)$$

If the modulus input is zero, then the N divider is simply an integer N divider. The output from the PLL is determined by the following formula:

$$F_{out} = (F_{in} * N) / (M * P)$$

Please see over for more details on the PLL and common settings.

Further Notes on PLL Programming

The sigma-delta PLL is designed to drive audio circuits requiring accurate clock frequencies of up to 25MHz with frequency errors noise-shaped away from the audio band. The 5 bits of modulus control provide exact synchronization of 48kHz and 44.1kHz sample rates from any common clock source when the oversampling rate of the audio system is 125fs. In systems where 128x oversampling must be used (for example with an isochronous I2S data stream) a clock synchronous to the sample rate should be used as input to the PLL (typically the I2S clock). If no isochronous source is available then the PLL can be used to obtain a clock that is accurate to within typical crystal tolerances of the real sample rate.

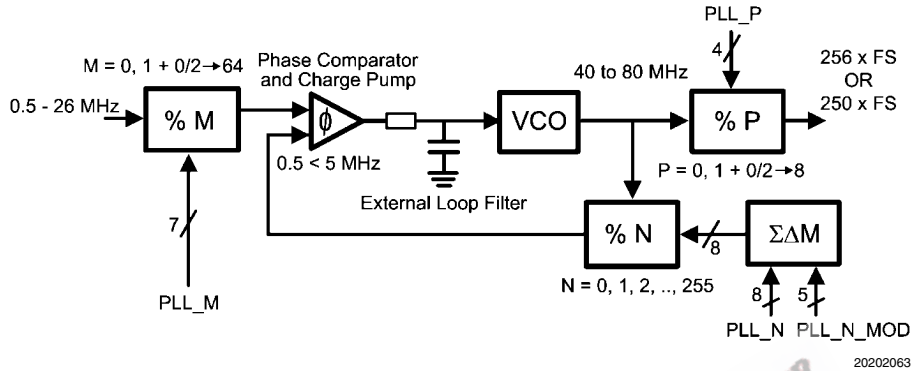

Example Of PLL Settings For 48Khz Sample Rates

f_in (MHz)	fsamp (kHz)	M	N	P	PLL_M	PLL_N	PLL_N_MOD	PLL_P	f_out (MHz)
11	48	11	60	5	21	60	0	9	12
12	48	5	25	5	9	25	0	9	12
12.288	48	4	19.53125	5	7	19	17	9	12
13	48	13	60	5	25	60	0	9	12
14.4	48	9	37.5	5	17	37	16	9	12
16.2	48	27	100	5	53	100	0	9	12
16.8	48	14	50	5	27	50	0	9	12
19.2	48	13	40.625	5	25	40	20	9	12
19.44	48	27	100	6	53	100	0	11	12
19.68	48	20.5	62.5	5	40	62	16	9	12
19.8	48	16.5	50	5	32	50	0	9	12

Example PLL Settings For 44.1Khz Sample Rates

f_in (MHz)	fsamp (kHz)	M	N	P	PLL_M	PLL_N	PLL_N_MOD	PLL_P	f_out (MHz)
11	44.1	11	55.125	5	21	55	4	9	11.025000
11.2896	44.1	8	39.0625	5	15	39	2	9	11.025000
12	44.1	5	22.96875	5	9	22	31	9	11.025000
13	44.1	13	55.125	5	25	55	4	9	11.025000
14.4	44.1	12	45.9375	5	23	45	30	9	11.025000
16.2	44.1	9	30.625	5	17	30	20	9	11.025000
16.8	44.1	17	55.78125	5	33	55	25	9	11.025000
19.2	44.1	16	45.9375	5	31	45	30	9	11.025000
19.44	44.1	13.5	38.28125	5	26	38	9	9	11.025000
19.68	44.1	20.5	45.9375	4	40	45	30	7	11.025000
19.8	44.1	11	30.625	5	21	30	20	9	11.025000

These tables cover the most common applications, obtaining clocks for sample rates such as 22.05kHz and 192kHz should be done by changing the P divider value or the R divider in the clock configuration diagram.

If the user needs to obtain a clock unrelated to those described above, the following method is advised. An example of obtaining 11.2896 from 12.000MHz is shown below.

Choose a small range of P so that the VCO frequency is swept between 45 and 55MHz (or 60-80MHz if VCOFAST is used). Remembering that the P divider can divide by half integers. So for P = 4.0 → 7.0 sweep the M inputs from 2.5 → 24. The most accurate N and N_MOD can be calculated by:

$$N = \text{FLOOR}(((F_{\text{out}}/F_{\text{in}})*(P*M)),1)$$

$$N_MOD = \text{ROUND}(32*(((F_{\text{out}}/F_{\text{in}})*(P*M)-N),0)$$

This shows that setting M = 11.5, N = 75 N_MOD = 47 P = 7 gives a comparison frequency of just over 1MHz, a VCO frequency of just under 80MHz (so VCO_FAST must be set) and an output frequency of 11.289596 which gives a sample rate of 44.099985443kHz, or accurate to 0.33 ppm.

Care must be taken when synchronization of isochronous data is not possible, i.e. when the PLL has to be used in the above mode. The I2S should be master on the LM4937 so that the data source can support appropriate SRC as required. This method should only be used with data being read on demand to eliminate sample rate mismatch problems.

Where a system clock exists at an integer multiple of the required DAC clock rate it is preferable to use this rather than the PLL. The LM4937 is designed to work in 8,12,16,24,32, and 48kHz modes from a 12MHz clock without the use of the PLL. This saves power and reduces clock jitter.

Clock Configuration Register

This register is used to control the multiplexers and clock R divider in the clock module.

CLOCK (09h) (Set = logic 1, Clear = logic 0)

Bits	Register	Description	
0	FAST_CLOCK	If set master clock is divided by two.	
		FAST_CLOCK	MCLK Frequency
		0	Normal
		1	Divided by 2
1	PLL_INPUT	Programs the PLL input multiplexer to select:	
		PLL_INPUT	PLL Input Source
		0	MCLK
		1	I2S Input Clock
2	AUDIO_CLK_SEL	Selects which clock is passed to the audio sub-system	
		DAC_CLK_SEL	DAC Sub-system Input Source
		0	PLL Input
		1	PLL Output
3	PLL_ENABLE	If set enables the PLL. (MODES 4–7 only)	

Bits	Register	Description	
7:4	R_DIV	Programs the R divider	
		R_DIV	Divide Value
		0000	1
		0001	1
		0010	1.5
		0011	2
		0100	2.5
		0101	3
		0110	3.5
		0111	4
		1000	4.5
		1001	5
		1010	5.5
		1011	6
		1100	6.5
		1101	7
1110	7.5		
1111	8		

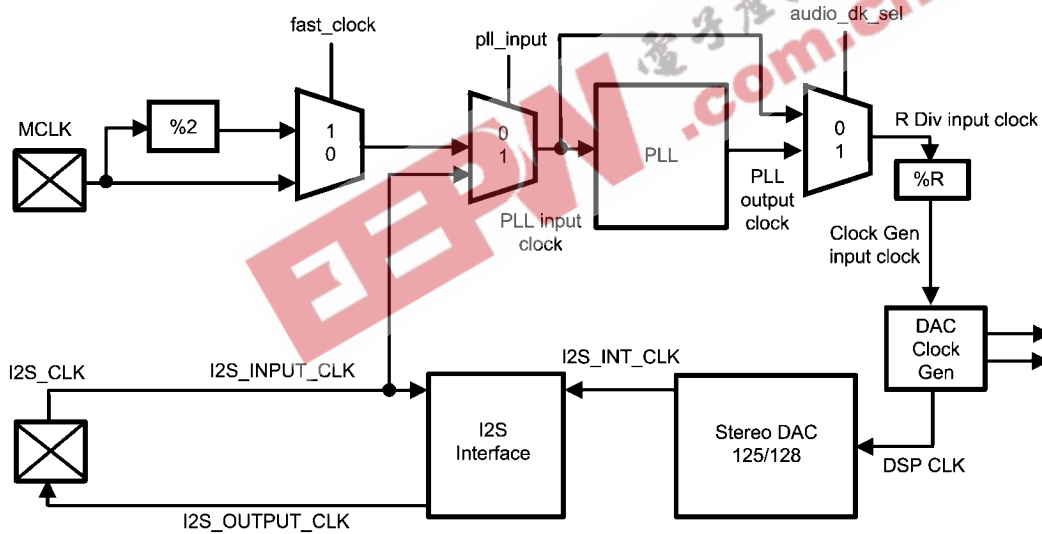

20202053

By default the stereo DAC operates at $250 \cdot f_s$, i.e. 12.000MHz (at the clock generator input clock) for 48kHz data. It is expected that the PLL be used to drive the audio system unless a 12.000MHz master clock is supplied. The PLL can also use the I2S clock input as a source. In this case, the audio DAC uses the clock from the output of the PLL.

Common Clock Settings for the DAC

The DAC can work in 4 modes, each with different oversampling rates, 125, 128, 64 & 32. In normal operation 125x oversampling provides for the simplest clocking solution as it will work from 12.000MHz (common in most systems with Bluetooth or USB) at 48kHz exactly. The other modes are useful if data is being provided to the DAC from an uncontrollable isochronous source (such as a CD player, DAB, or other external digital source) rather than being decoded from memory. In this case the PLL can be used to derive a clock for the DAC from the I2S clock.

The DAC oversampling rate can be changed to allow simpler clocking strategies, this is controlled in the DAC SETUP register but the oversampling rates are as follows:

DAC MODE	Over sampling Ratio Used
00	125
01	128
10	64
11	32

The following table describes the clock required at the clock generator input for various clock sample rates in the different DAC modes:

Fs (kHz)	DAC Oversampling Ratio	Required CLock at DAC Clock Generator Input (MHz)
8	125	2
8	128	2.048
11.025	125	2.75625
11.025	128	2.8224
12	125	3
12	128	3.072
16	125	4
16	128	4.096
22.05	125	5.5125
22.05	128	5.6448
24	125	6
24	128	6.144
32	125	8
32	128	8.192
44.1	125	11.025
44.1	128	11.2896
48	125	12
48	128	12.288
88.2	64	11.2896
96	64	12.288
176.4	32	22.5792
192	32	24.576

Methods for producing these clock frequencies are described in the PLL section.

The R divider can be used when the master clock is exactly 12.00 MHz in order to generate different sample rates. The Table below shows different sample rates supported from 12.00MHz by using only the R divider and disabling the PLL. In this way we can save power and the clock jitter will be low.

R_DIV	Divide Value	DAC Clock Generator Input Frequency <MHz>	Sample Rate Supported <KHz>
11	6	2	8
9	5	2.4	9.6
7	4	3	12
5	3	4	16
4	2.5	4.8	19.2

R_DIV	Divide Value	DAC Clock Generator Input Frequency <MHz>	Sample Rate Supported <KHz>
3	2	6	24
2	1.5	8	32
0	1	12	48

The R divider can also be used along with the P divider in order to create the clock needed to support low sample rates.

EEPW 电子产品世界
.com.cn

DAC Setup Register

This register is used to configure the basic operation of the stereo DAC.

DAC_SETUP (0Eh) (Set = logic 1, Clear = logic 0)

Bits	Register	Description			
1:0	DAC_MODE	The DAC used in the LM4937 can operate in one of 4 oversampling modes. The modes are described as follows:			
		DAC_MODE	Oversampling Rate	Typical FS	Clock Required
		00	125	48KHz	12.000MHz (USB Mode)
		01	128	44.1KHz 48KHz	11.2896MHz 12.288MHz
		10	64	96KHz	12.288MHz
	11	32	192KHz	24.576MHz	
2	MUTE_L	Mutes the left DAC channel on the next zero crossing.			
3	MUTE_R	Mutes the right DAC channel on the next zero crossing.			
4	DITHER_OFF	If set the dither in DAC is disabled.			
5	DITHER ALWAYS_ON	If set the dither in DAC is enabled all the time.			
6	CUST_COMP	If set the DAC frequency response can be programmed manually via a 5 tap FIR "compensation" filter. This can be used to enhance the frequency response of small loudspeakers or provide a crude tone control. The compensation Coefficients can be set by using registers 10h to 15h.			

Interface Control Register

This register is used to control the I2S and I²C compatible interface on the chip.

INTERFACE (0Fh) (Set = logic 1, Clear = logic 0)

Bits	Register	Description
0	I2S_MASTER_SLAVE	If set the LM4937 acts as a master for I2S, so both I2S clock and I2S word select are configured as outputs. If cleared the LM4937 acts as a slave where both I2S clock and word select are configured as inputs.
1	I2S_RESOLUTION	If set the I2S resolution is set to 32 bits. If clear, resolution is set to 16 bits. This bit only affects the I2S Interface in master mode. In slave mode the I2S Interface can support any I2S compatible resolution. In master mode the I2S resolution also depends on the DAC mode as the note below explains.
2	I2S_MODE	If set the I2S is configured in left justified mode timing. If clear, the I2S interface is configured in normal I2S mode timing.
3	I2C_FAST	If set enables the I2C to run in fast mode with an I2C clock up to 3.4MHz. If clear the I2C speed gets its default value of a maximum of 400kHz

NOTES:

The master I2S format depends on the DAC mode. In USB mode the number of bits per word is 25 (i.e. 2.4MHz for a 48kHz sample rate). The duty cycle is 40/60. In non-USB modes the format is 32 or 16 bits per word, depending on I2S_RESOLUTION and the duty cycle is always 50-50. In slave mode it will decode any I2S compatible data stream.

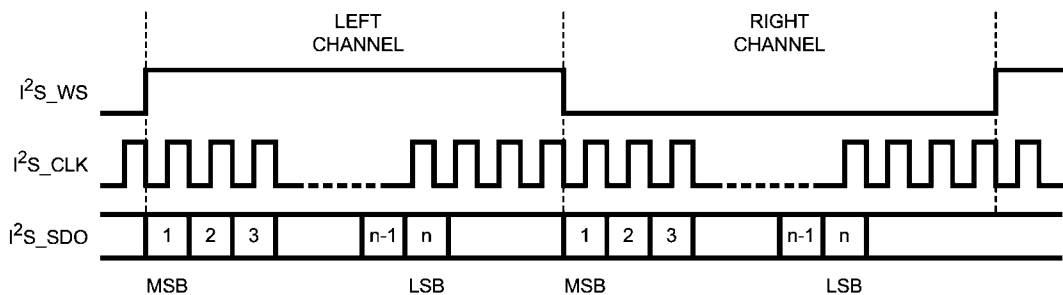
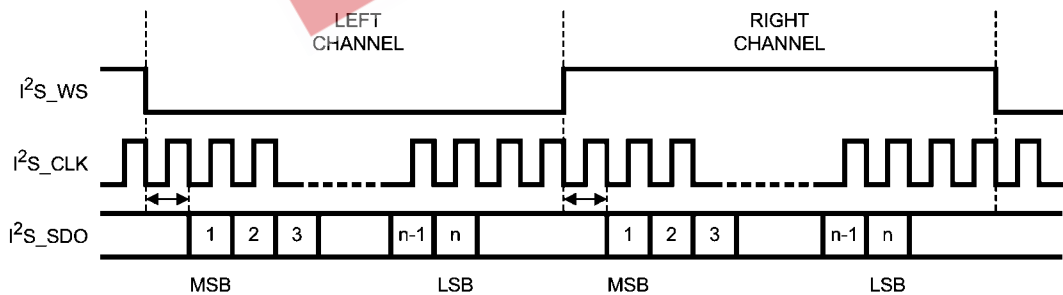

FIR Compensation Filter Configuration Registers

must be programmed via the I2C/SPI Interface in bytes as follows:

These registers are used to configure the DAC's FIR compensation filter. Three 16 bit coefficients are required and

COMP_COEFF (10h → 15h) (Set = logic 1, Clear = logic 0)

Address	Register	Description
10h	COMP_COEFF0_LSB	Bits [7:0] of the 1st and 5th FIR tap (C0 and C4)
11h	COMP_COEFF0_MSB	Bits [15:8] of the 1st and 5th FIR tap (C0 and C4)
12h	COMP_COEFF1_LSB	Bits [7:0] of the 2nd and 4th FIR tap (C1 and C3)
13h	COMP_COEFF1_MSB	Bits [15:8] of the 2nd and 4th FIR tap (C1 and C3)
14h	COMP_COEFF2_LSB	Bits [7:0] of the 3rd FIR tap (C2)
15h	COMP_COEFF2_MSB	Bits [15:8] of the 3rd FIR tap (C2)

NOTES:

The filter must be phase linear to ensure the data keeps the correct stereo imaging so the second half of the FIR filter must be the reverse of the 1st half.

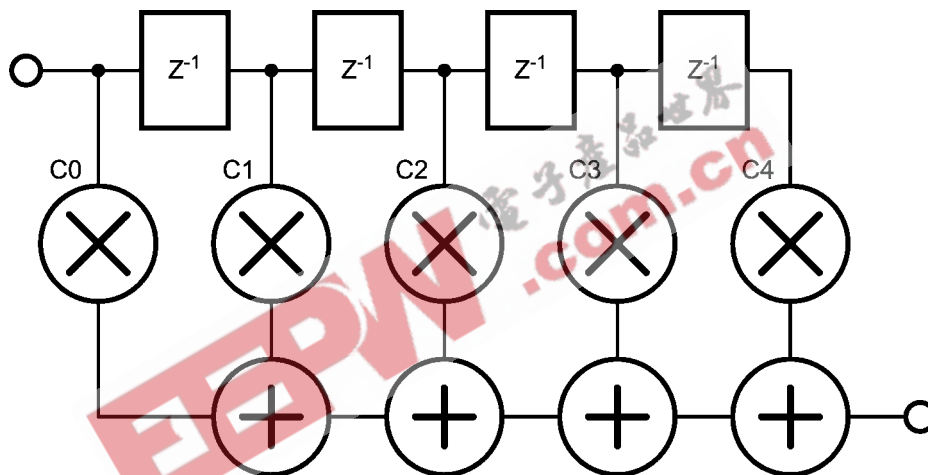

20202055

If the CUST_COMP option in register 0Eh is not set the FIR filter will use its default values for a linear response from the DAC into the analog mixer, these values are:

DAC_OSR	C0, C4	C1, C3	C2
00	434	-2291	26984
01, 10, 11	61	-371	25699

If using 96 or 192kHz data then the custom compensation may be required to obtain flat frequency responses above 24kHz. The total power of any custom filter must not exceed

that of the above examples or the filters within the DAC will clip. The coefficient must be programmed in 2's complement.

Typical Performance Characteristics

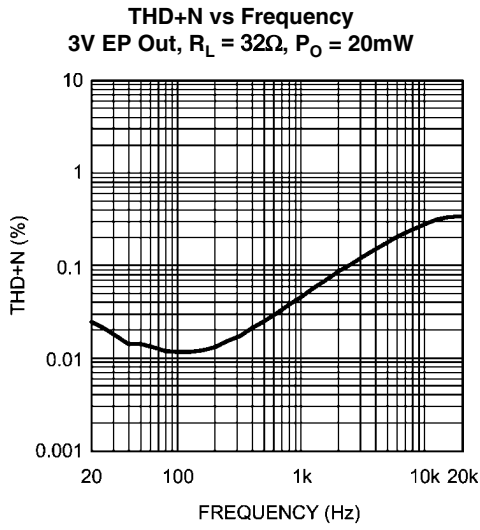

20202064

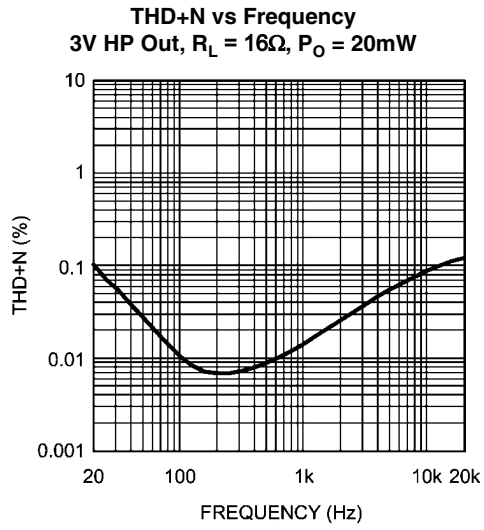

20202065

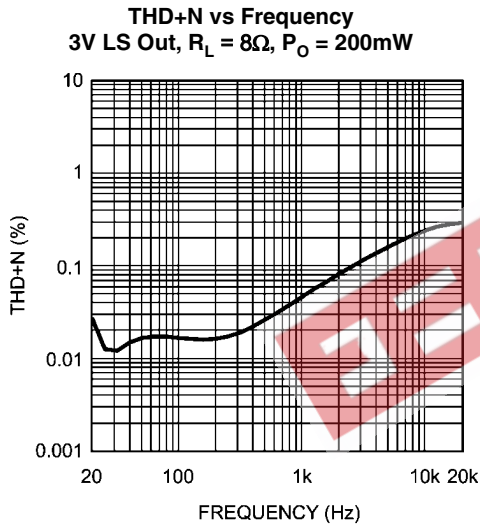

20202066

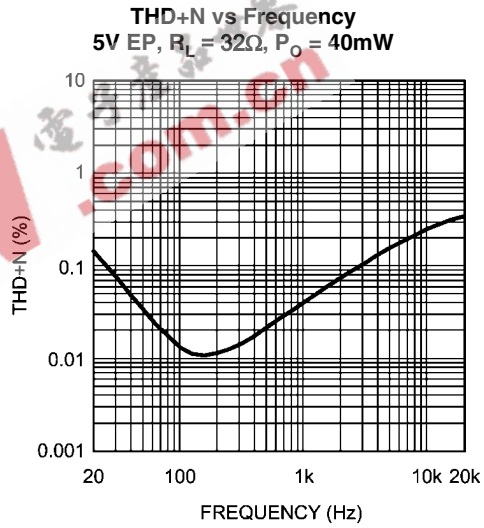

20202067

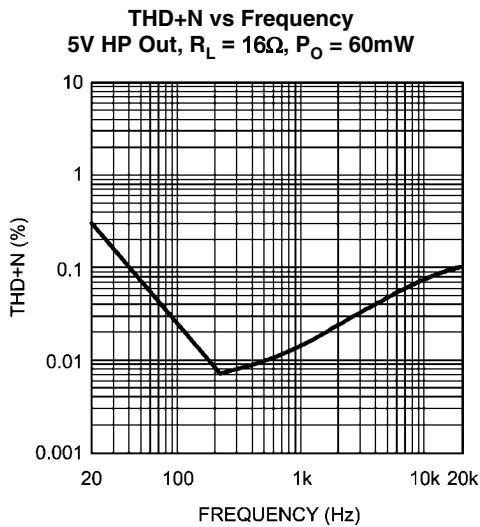

20202069

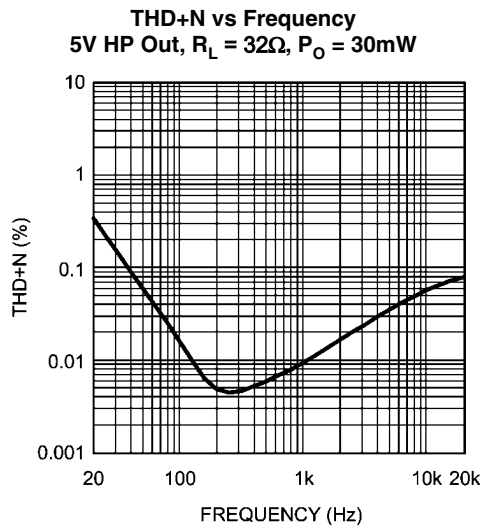

20202070

THD+N vs Frequency
5V LS Out, $R_L = 8\Omega$, $P_O = 500mW$

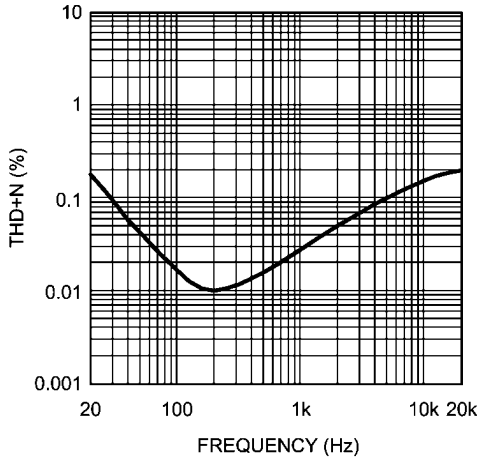

20202071

THD+N vs Output Power
3V EP Out, $R_L = 16\Omega$, $f = 1kHz$

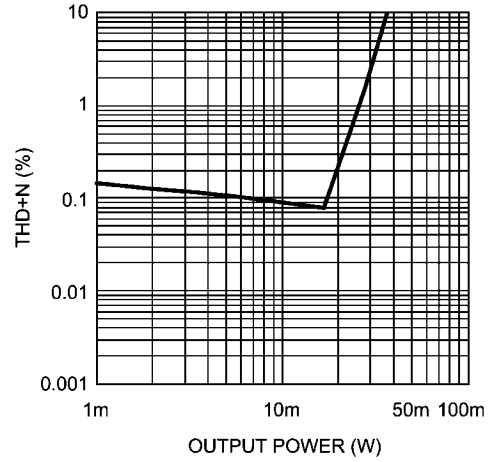

20202072

THD+N vs Output Power
3V EP Out, $R_L = 32\Omega$, $f = 1kHz$

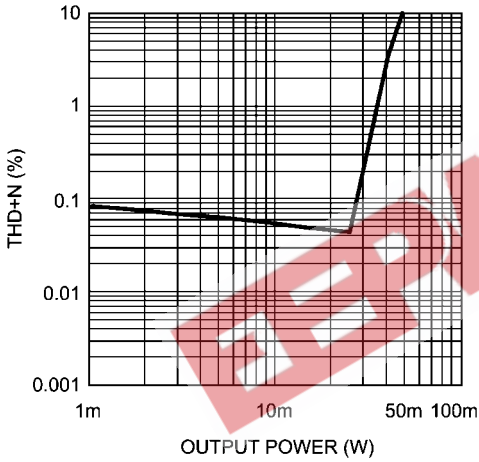

20202073

THD+N vs Output Power
3V HP Out, $R_L = 16\Omega$, $f = 1kHz$

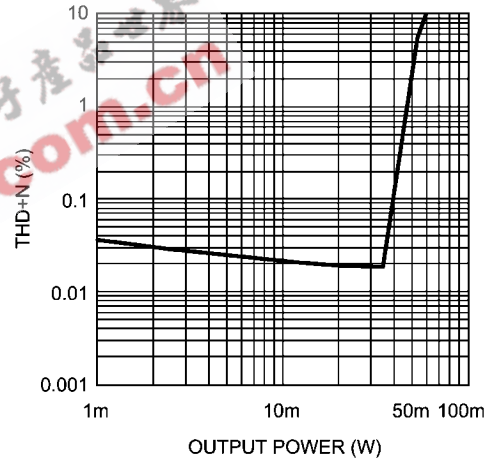

20202076

THD+N vs Output Power
3V HP Out, $R_L = 32\Omega$, $f = 1kHz$

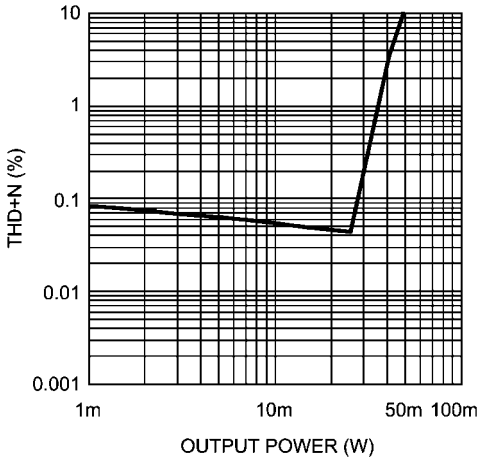

20202077

THD+N vs Output Power
3V LS Out, $R_L = 8\Omega$, $f = 1kHz$

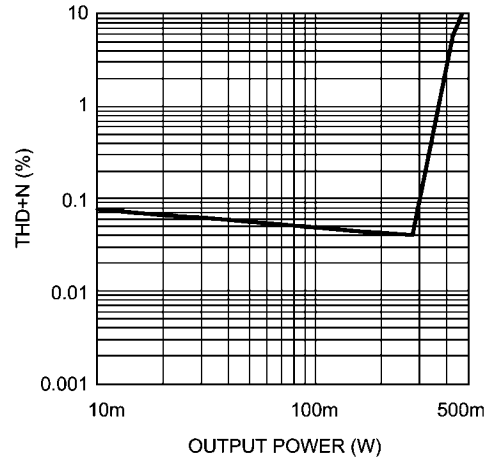

20202019

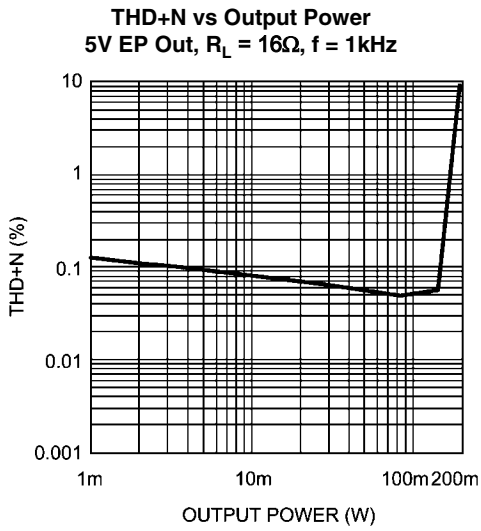

20202078

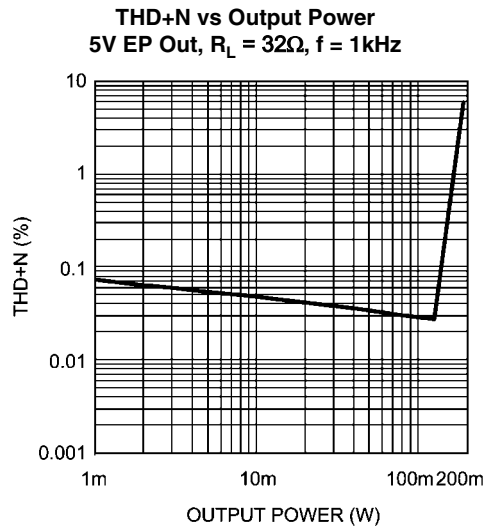

20202079

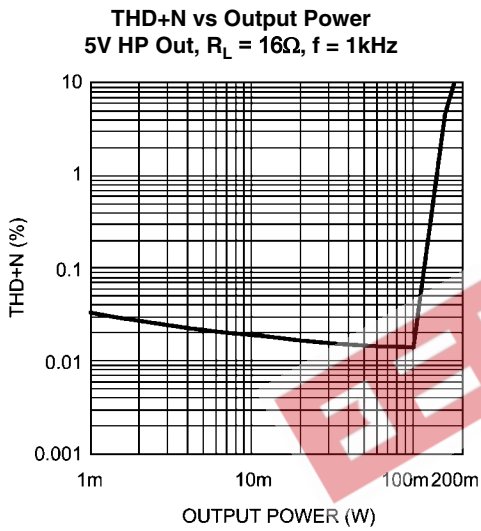

20202080

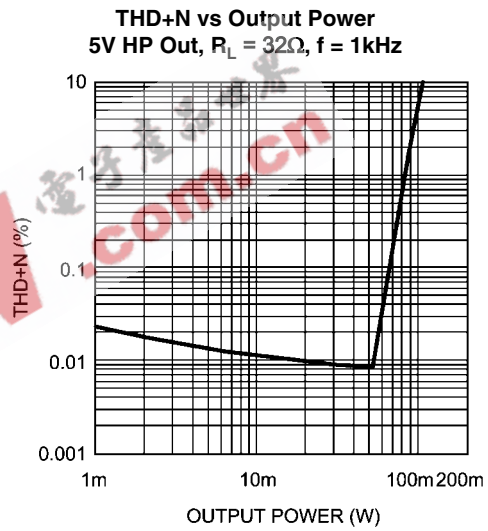

20202081

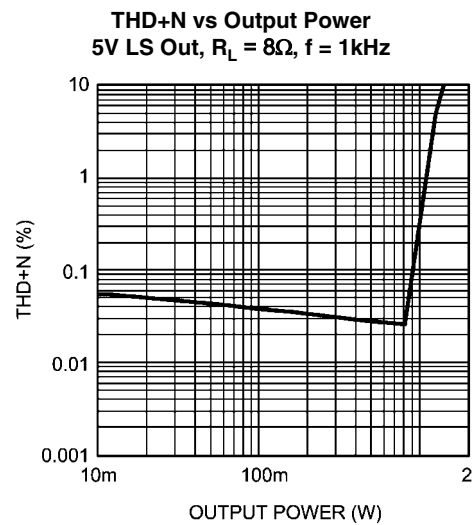

20202082

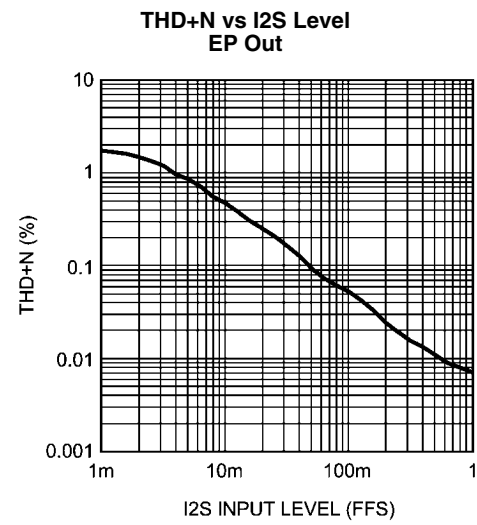

20202083

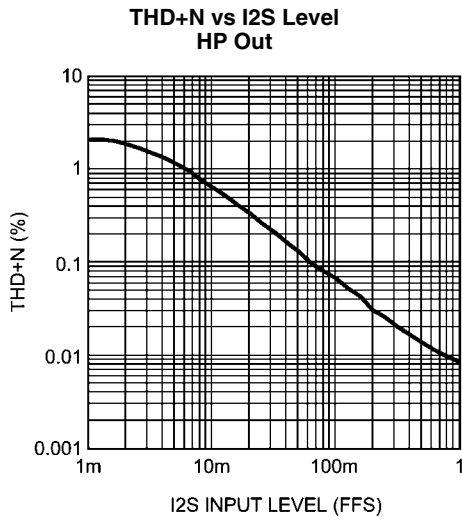

20202084

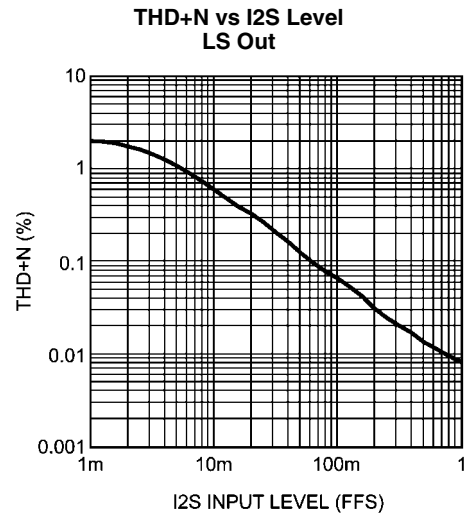

20202085

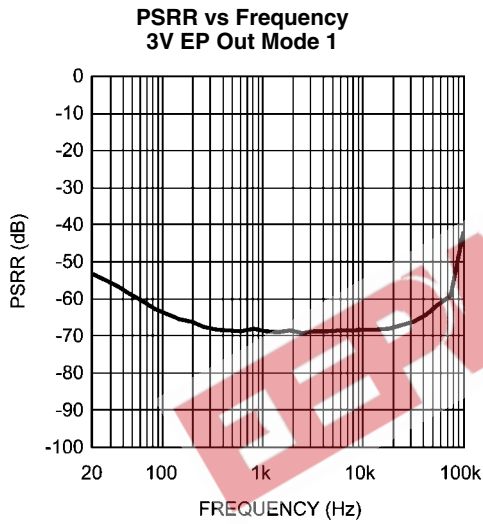

20202086

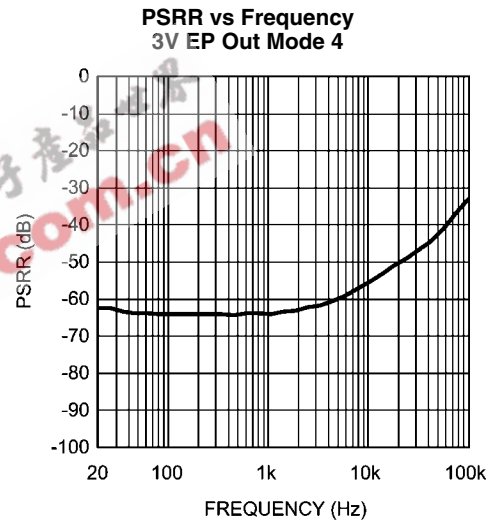

20202087

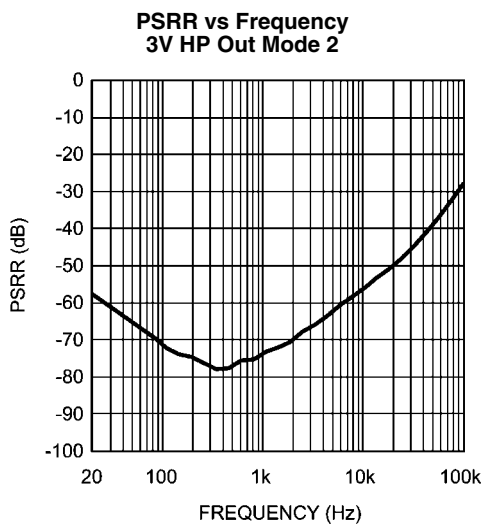

20202088

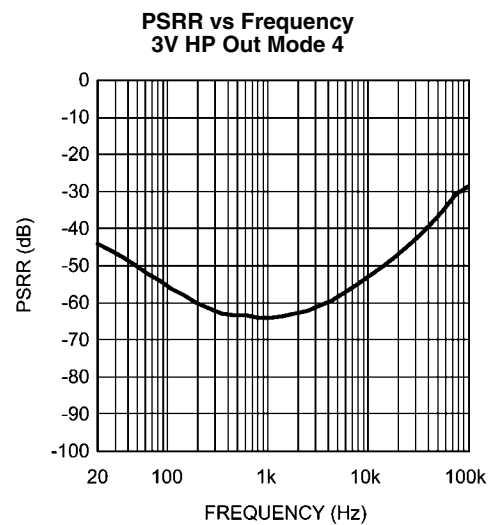

20202089

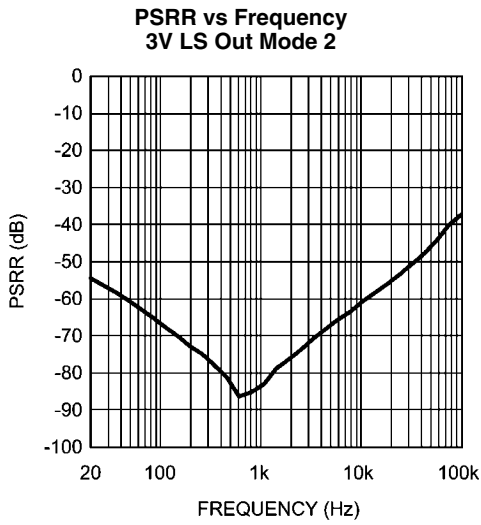

20202090

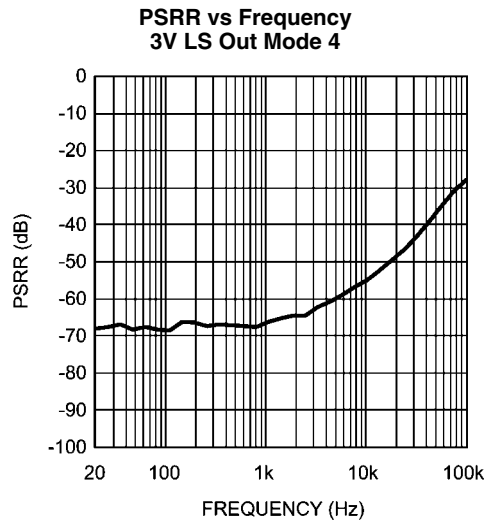

20202091

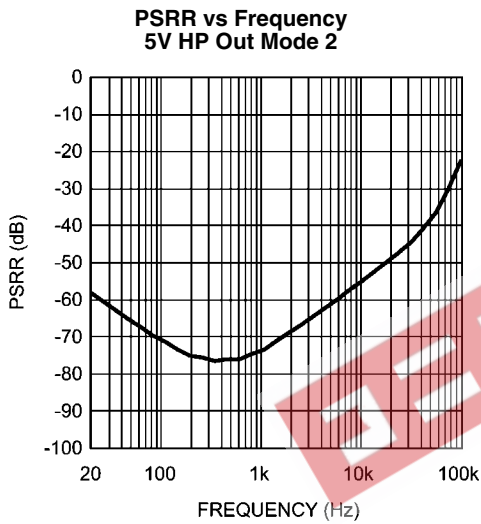

20202092

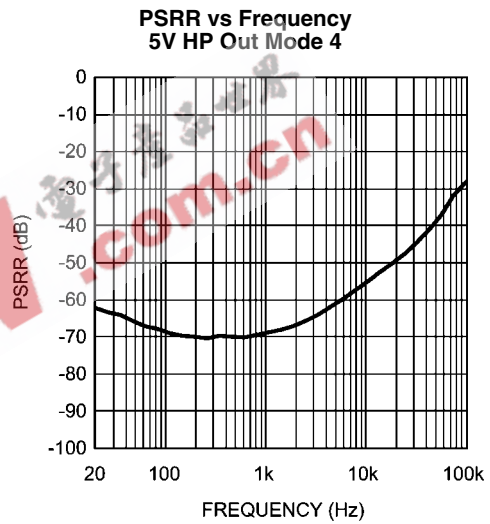

20202093

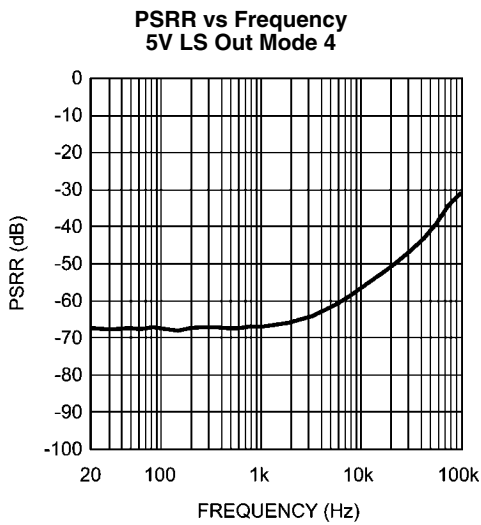

20202094

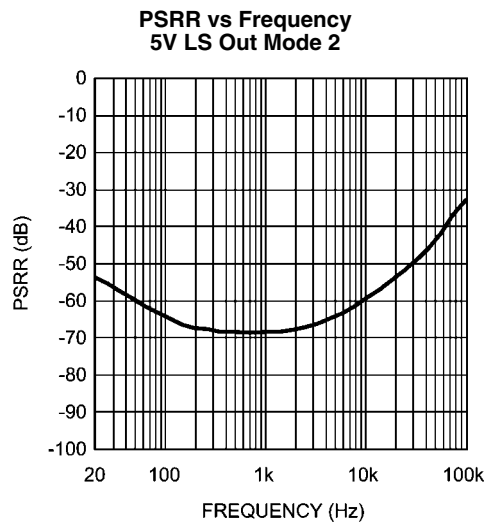

20202095

Output Power vs Supply Voltage
EP Out , $R_L = 32\Omega$, 1% THD+N

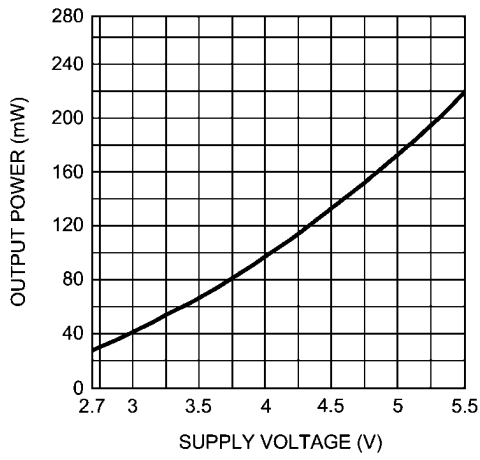

20202096

Output Power vs Supply Voltage
HP Out , $R_L = 32\Omega$, 1% THD+N

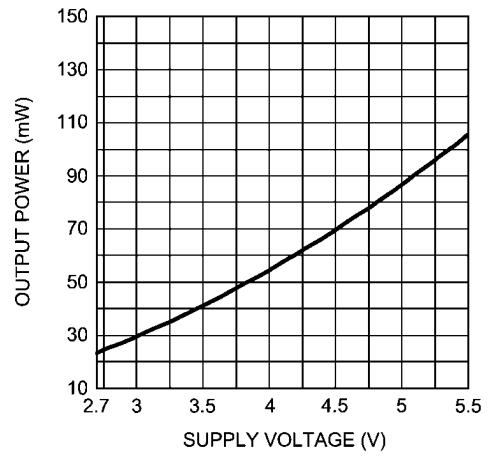

20202097

Output Power vs Supply Voltage
LS Out , $R_L = 8\Omega$, 1% THD+N

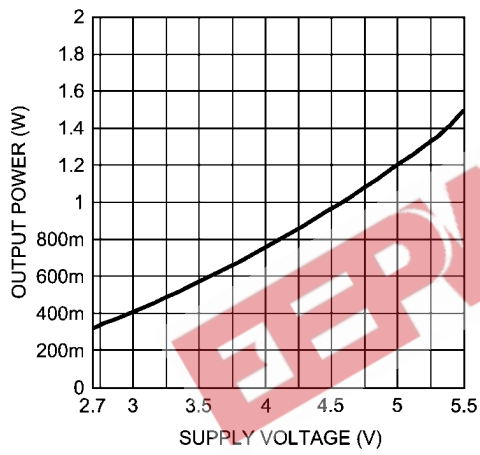

20202098

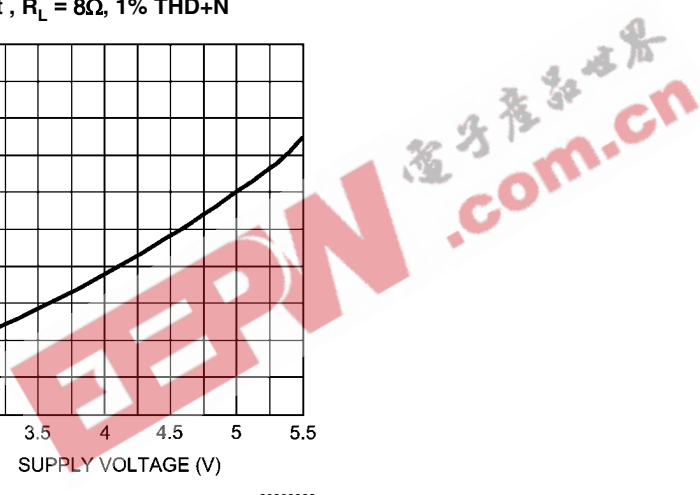

Application Information

I²S

The LM4937 supports both master and slave I²S transmission at either 16 or 32 bits per word at clock rates up to 3.072MHz (48kHz stereo, 32bit). The basic format is shown below:

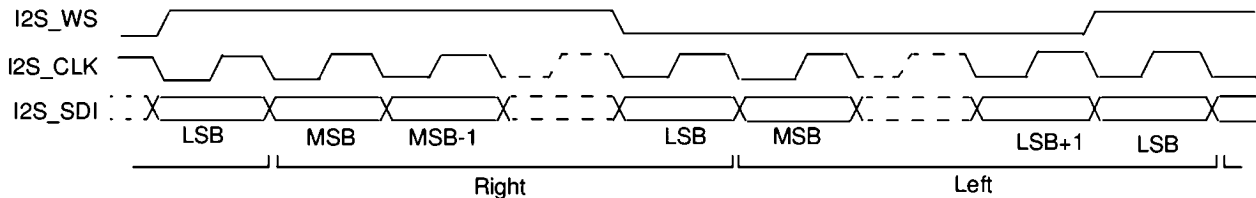

20202007

FIGURE 4.

MONO ONLY SETTING

The LM4937 may be restricted to mono amplification only by setting D-6 in Output Control register 0x01h to 1. This may save an additional 400 μ A from I_{DD}.

LM4937 DEMOBOARD OPERATION

BOARD LAYOUT

DIGITAL SUPPLIES

- JP14 — Digital Power DVDD
- JP10 — I/O Power IOVDD
- JP13 — PLL Supply PLLVDD
- JP16 — USB Board Supply BBVDD
- JP15 — I2C VDD

All supplies may be set independently. All digital ground is common. Jumpers may be used to connect all the digital supplies together.

- S9 – connects VDD_PLL to VDD_D
- S10 – connects VDD_D to VDD_IO
- S11 – connects VDD_IO to VDD_I2C
- S12 – connects VDD_I2C to Analog VDD
- S17 – connects BB_VDD to USB3.3V (from USB board)
- S19 – connects VDD_D to USB3.3V (from USB board)
- S20 – connects VDD_D to SPDIF receiver chip

ANALOG SUPPLY

- JP11 — Analog Supply
- S12 — connects Analog VDD with Digital VDD (I2C_VDD)
- S16 — connects Analog Ground with Digital Ground
- S21 — connects Analog VDD to SPDIF receiver chip

INPUTS

Analog Inputs

- JP2 — Mono Differential Input
- JP6 — Left Input
- JP7 — Right Input

Digital Inputs

- JP19 — Digital Interface
- Pin 1 — MCLK
- Pin 2 — I2S_CLK

- Pin 3 — I2S_SDI
- Pin 4 — I2S_WS
- JP20 — Toslink SPDIF Input
- JP21 — Coaxial SPDIF Input

Coaxial and Toslink inputs may be toggled between by use of S25. Only one may be used at a time. Must be used in conjunction with on-board SPDIF receiver chip.

OUTPUTS

- JP5 — BTL Loudspeaker Output
- JP1 — Left Headphone Output (Single-Ended or OCL)
- JP3 — Right Headphone Output (Single-Ended or OCL)
- P1 — Stereo Headphone Jack (Same as JP1, JP2, Single-Ended or OCL)
- JP12 — Mono BTL Earpiece Output

CONTROL INTERFACE

- X1, X2 – USB Control Bus for I2C/SPI

- X1
- Pin 9 – Mode Select (SPI or I2C)

- X2
- Pin 1 – SDA
- Pin 3 – SCL
- Pin 15 – ADDR/END
- Pin 14 – USB5V
- Pin 16 – USB3.3V
- Pin 16 – USB GND

MISCELLANEOUS

I2S BUS SELECT

S23, S24, S26, S27 – I2S Bus select. Toggles between on-board and external I2S (whether on-board SPDIF receiver is used). All jumpers must be set the same. Jumpers on top two

pins selects external bus (JP19). Jumpers on bottom two pins selects on-board SPDIF receiver output.

HEADPHONE OUTPUT CONFIGURATION

Jumpers S1, S2, S3, and S4 are used to configure the headphone outputs for either cap-coupled outputs or output capacitorless (OCL) mode in addition to the register control internal to the LM4937 for this feature. Jumpers S1 and S3 bypass the output DC blocking capacitors when OCL mode is required. S2 connects the center amplifier HPCOUT to the headphone ring when in OCL mode. S4 connects the center ring to GND when cap-coupled mode is desired. S4 must be removed for OCL mode to function properly. Jumper settings for each mode:

OCL (CD_6 = 1)

S1 = ON

S2 = ON

S3 = ON

S4 = OFF

Cap-Coupled (CD_6 = 0)

S1 = OFF

S2 = OFF

S3 = OFF

S4 = ON

PLL FILTER CONFIGURATION

The LM4937 demo board comes with a simple filter setup by connecting jumpers S5 and S6. Removing these and connecting jumpers S7 and S8 will allow for an alternate PLL filter configuration to be used at R2 and C23.

ON-BOARD SPDIF RECEIVER

The SPDIF receiver present on the LM4937 demo board allows quick demonstration of the capabilities of the LM4937 by

using the common SPDIF output found on most CD/DVD players today. There are some limitations in its useage, as the receiver will not work with digital supplies of less than 3V and analog supplies of less than 4V. This means low analog supply voltage testing of the LM4937 must be done on the external digital bus.

The choice of using on-board or external digital bus is made using jumpers S23, S24, S26, and S27 as described above. S25 selects whether the Toslink or Coaxial SPDIF input is used. The top two pins connects the toslink, the bottom two connect the coaxial input.

Power on the digital side is routed through S20 (connecting to the other digital supplies), while on the analog side it is interrupted by S21. Both jumpers must be in place for the receiver to function. The part is already configured for I2S standard outputs. Jumper S28 allows the DATA output to be pulled either high or low. Default is high (jumper on right two pins).

It may be necessary to quickly toggle S29 to reset the receiver and start it working upon initial power up.. A quick short across S29 should clear this condition.

LM4937 I²C/SPI INTERFACE SOFTWARE

Convenient graphical user interface software is available for demonstration purposes of the LM4937. It allows for either SPI or I²C control via either USB or parallel port connections to a Windows computer. Control options include all mode and output settings, volume controls, PLL and DAC setup, FIR setting and on-the-fly adjustment by an easy to use graphical interface. An advanced option is also present to allow direct, register-level commands. Software is available from www.national.com and is compatible with Windows operating systems of Windows 98 or more (with USB support) with the latest .NET updates from Microsoft.

Demonstration Board Schematic

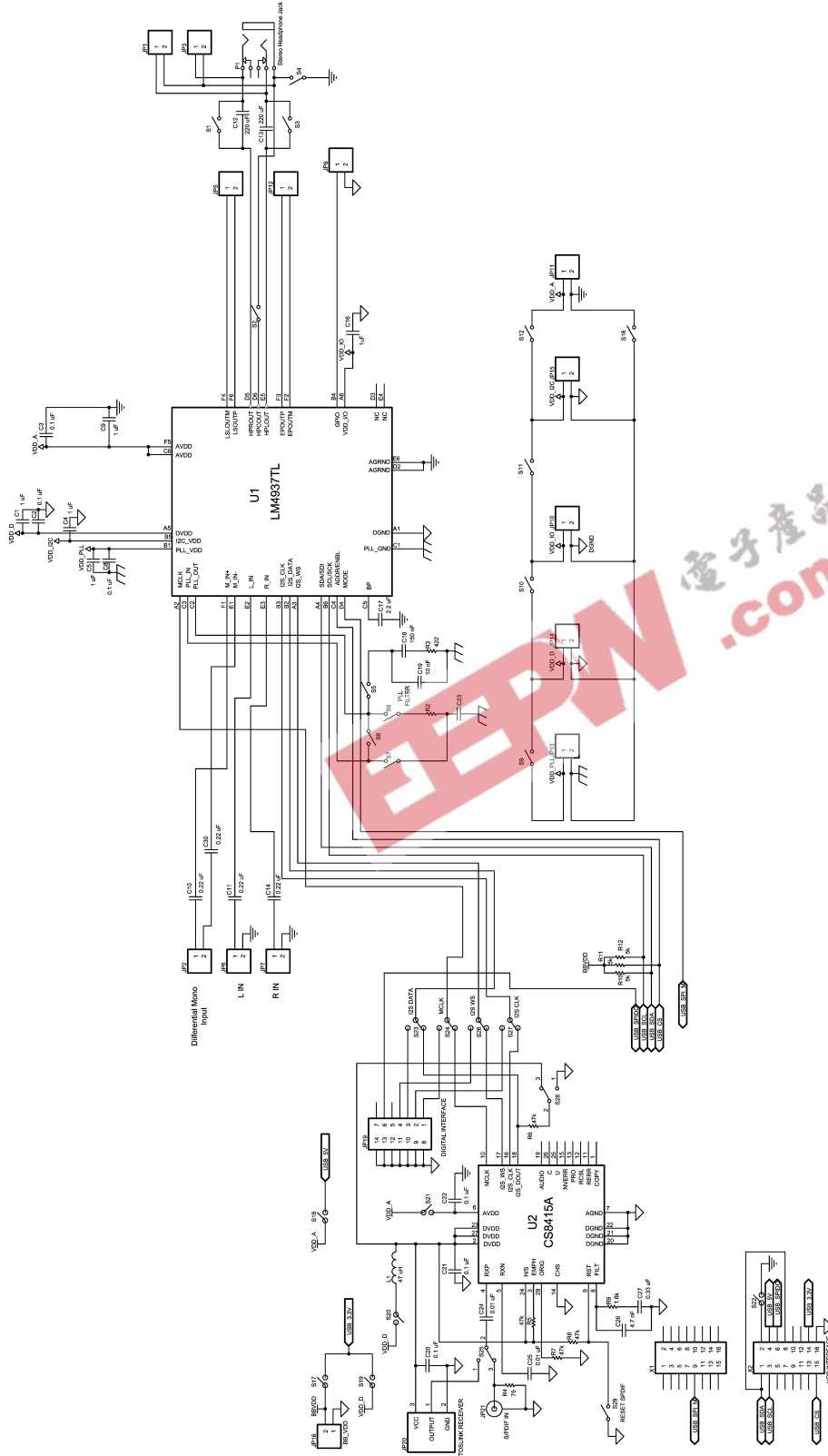

20020003

Enlarged Graphic part 1 of 2

LM4937

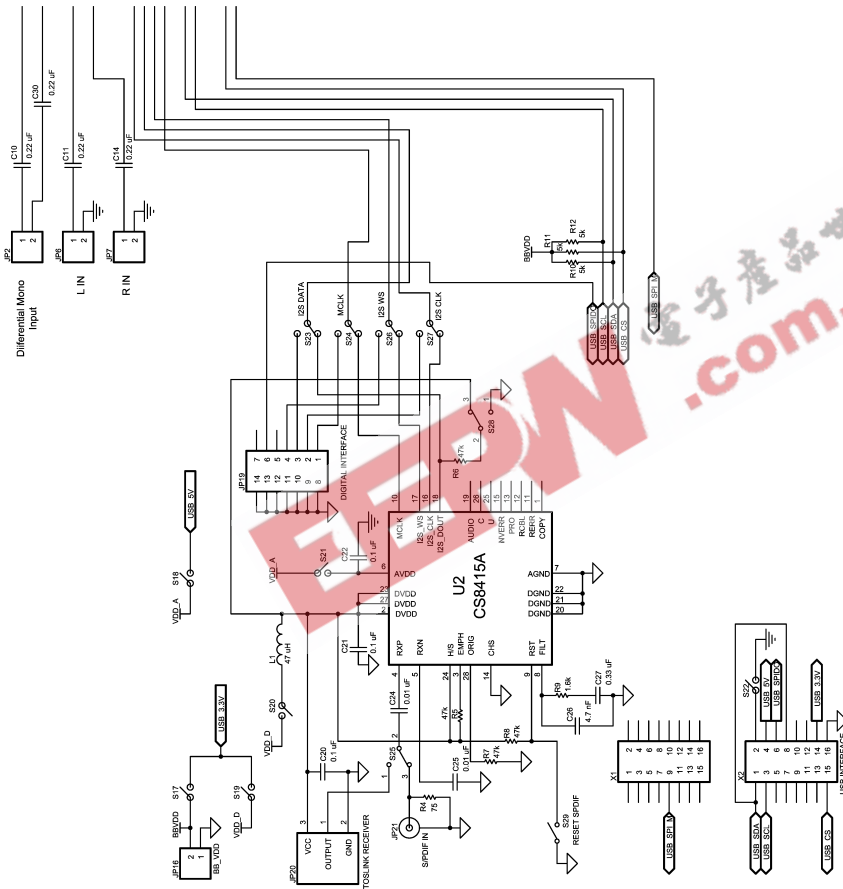

20202006

Enlarged Graphic part 2 of 2

电子产品世界 .com.cn

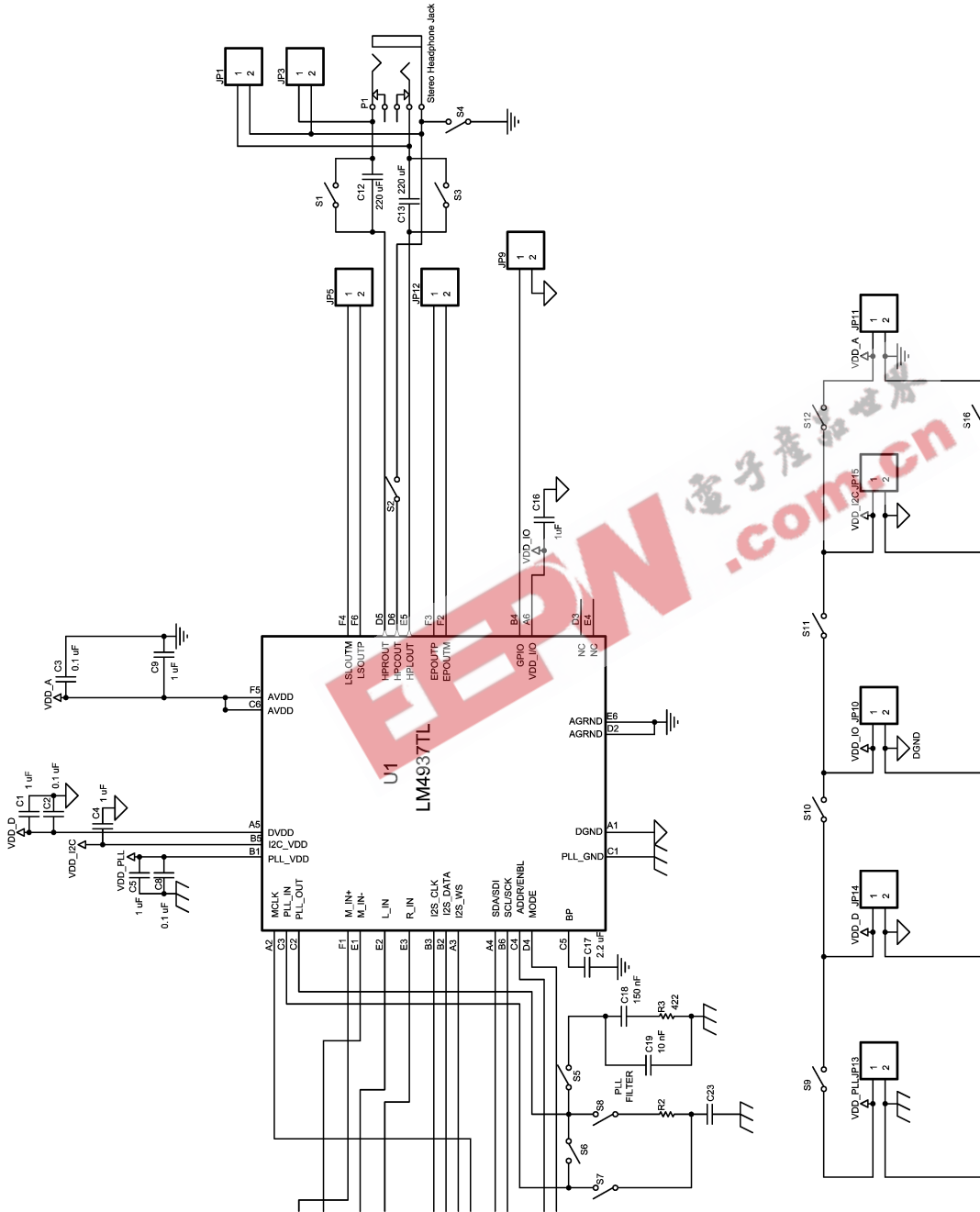

202020K7

Enlarged Graphic part 2 of 2

Revision History

Rev	Date	Description
1.0	10/04/06	Initial release.
1.1	10/13/06	Text edits.
1.2	12/15/06	Changed the datasheet title from RF Resistant Topology to RF Suppression.
1.3	02/09/07	Replaced curve (THD+N vs Output Power, 3V LS Out) with the curve 20166975 from LM4934. These 2 curves have identical performance).

EEPW 电子产品世界
.com.cn

Physical Dimensions inches (millimeters) unless otherwise noted

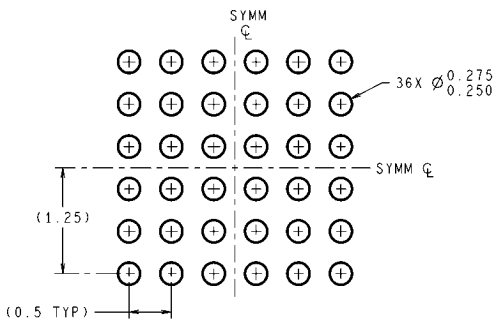

LAND PATTERN RECOMMENDATION

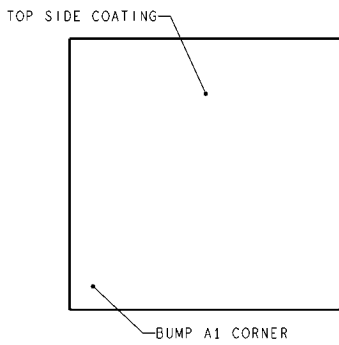

DIMENSIONS ARE IN MILLIMETERS
DIMENSIONS IN () FOR REFERENCE ONLY

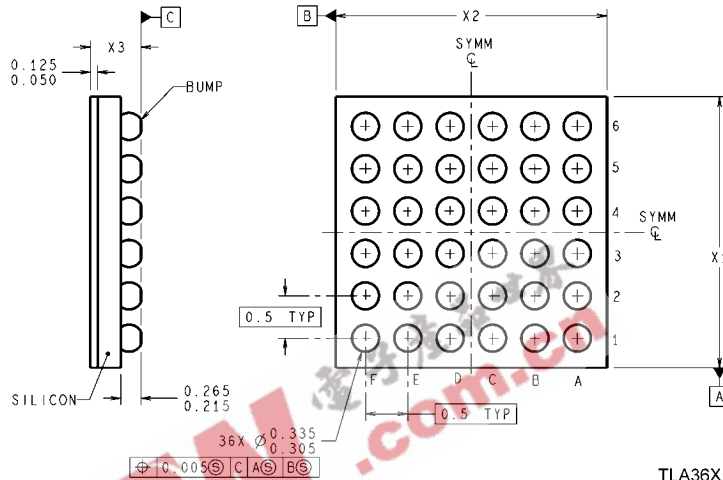

TLA36XXX (Rev D)

36-Bump micro SMD
Order Number LM4937TL
NS Package Number TLA36LVA
 $X_1 = 3255 \pm 30 \mu\text{m}$, $X_2 = 3510 \pm 30 \mu\text{m}$, $X_3 = 600 \pm 75 \mu\text{m}$

Notes

THE CONTENTS OF THIS DOCUMENT ARE PROVIDED IN CONNECTION WITH NATIONAL SEMICONDUCTOR CORPORATION ("NATIONAL") PRODUCTS. NATIONAL MAKES NO REPRESENTATIONS OR WARRANTIES WITH RESPECT TO THE ACCURACY OR COMPLETENESS OF THE CONTENTS OF THIS PUBLICATION AND RESERVES THE RIGHT TO MAKE CHANGES TO SPECIFICATIONS AND PRODUCT DESCRIPTIONS AT ANY TIME WITHOUT NOTICE. NO LICENSE, WHETHER EXPRESS, IMPLIED, ARISING BY ESTOPPEL OR OTHERWISE, TO ANY INTELLECTUAL PROPERTY RIGHTS IS GRANTED BY THIS DOCUMENT.

TESTING AND OTHER QUALITY CONTROLS ARE USED TO THE EXTENT NATIONAL DEEMS NECESSARY TO SUPPORT NATIONAL'S PRODUCT WARRANTY. EXCEPT WHERE MANDATED BY GOVERNMENT REQUIREMENTS, TESTING OF ALL PARAMETERS OF EACH PRODUCT IS NOT NECESSARILY PERFORMED. NATIONAL ASSUMES NO LIABILITY FOR APPLICATIONS ASSISTANCE OR BUYER PRODUCT DESIGN. BUYERS ARE RESPONSIBLE FOR THEIR PRODUCTS AND APPLICATIONS USING NATIONAL COMPONENTS. PRIOR TO USING OR DISTRIBUTING ANY PRODUCTS THAT INCLUDE NATIONAL COMPONENTS, BUYERS SHOULD PROVIDE ADEQUATE DESIGN, TESTING AND OPERATING SAFEGUARDS.

EXCEPT AS PROVIDED IN NATIONAL'S TERMS AND CONDITIONS OF SALE FOR SUCH PRODUCTS, NATIONAL ASSUMES NO LIABILITY WHATSOEVER, AND NATIONAL DISCLAIMS ANY EXPRESS OR IMPLIED WARRANTY RELATING TO THE SALE AND/OR USE OF NATIONAL PRODUCTS INCLUDING LIABILITY OR WARRANTIES RELATING TO FITNESS FOR A PARTICULAR PURPOSE, MERCHANTABILITY, OR INFRINGEMENT OF ANY PATENT, COPYRIGHT OR OTHER INTELLECTUAL PROPERTY RIGHT.

LIFE SUPPORT POLICY

NATIONAL'S PRODUCTS ARE NOT AUTHORIZED FOR USE AS CRITICAL COMPONENTS IN LIFE SUPPORT DEVICES OR SYSTEMS WITHOUT THE EXPRESS PRIOR WRITTEN APPROVAL OF THE CHIEF EXECUTIVE OFFICER AND GENERAL COUNSEL OF NATIONAL SEMICONDUCTOR CORPORATION. As used herein:

Life support devices or systems are devices which (a) are intended for surgical implant into the body, or (b) support or sustain life and whose failure to perform when properly used in accordance with instructions for use provided in the labeling can be reasonably expected to result in a significant injury to the user. A critical component is any component in a life support device or system whose failure to perform can be reasonably expected to cause the failure of the life support device or system or to affect its safety or effectiveness.

National Semiconductor and the National Semiconductor logo are registered trademarks of National Semiconductor Corporation. All other brand or product names may be trademarks or registered trademarks of their respective holders.

Copyright© 2007 National Semiconductor Corporation

For the most current product information visit us at www.national.com



**National Semiconductor
Americas Customer
Support Center**
Email:
new.feedback@nsc.com
Tel: 1-800-272-9959

**National Semiconductor Europe
Customer Support Center**
Fax: +49 (0) 180-530-85-86
Email: europe.support@nsc.com
Deutsch Tel: +49 (0) 69 9508 6208
English Tel: +49 (0) 870 24 0 2171
Français Tel: +33 (0) 1 41 91 8790

**National Semiconductor Asia
Pacific Customer Support Center**
Email: ap.support@nsc.com

**National Semiconductor Japan
Customer Support Center**
Fax: 81-3-5639-7507
Email: jpn.feedback@nsc.com
Tel: 81-3-5639-7560