

FEATURES

- Fixed Output Voltages of 2.048 V, 2.5 V, 3 V, 4.096 V, 5 V, 8.192 V, and 10 V
- Tight Output Tolerances and Low Temperature Coefficient
 - Max 0.1%, 100 ppm/°C – A Grade
 - Max 0.2%, 100 ppm/°C – B Grade
 - Max 0.5%, 100 ppm/°C – C Grade
 - Max 1.0%, 150 ppm/°C – D Grade
- Low Output Noise...35 μV_{RMS} Typ
- Wide Operating Current Range...45 μA Typ to 15 mA
- Stable With All Capacitive Loads; No Output Capacitor Required
- Available in Extended Temperature Range...–40°C to 125°C

APPLICATIONS

- Data-Acquisition Systems
- Power Supplies and Power-Supply Monitors
- Instrumentation and Test Equipment
- Process Controls
- Precision Audio
- Automotive Electronics
- Energy Management
- Battery-Powered Equipment

DESCRIPTION/ORDERING INFORMATION

The LM4040 series of shunt voltage references are versatile, easy-to-use references that cater to a vast array of applications. The 2-pin fixed-output device requires no external capacitors for operation and is stable with all capacitive loads. Additionally, the reference offers low dynamic impedance, low noise, and low temperature coefficient to ensure a stable output voltage over a wide range of operating currents and temperatures. The LM4040 uses fuse and Zener-zap reverse breakdown voltage trim during wafer sort to offer four output voltage tolerances, ranging from 0.1% (max) for the A grade to 1% (max) for the D grade. Thus, a great deal of flexibility is offered to designers in choosing the best cost-to-performance ratio for their applications.

Packaged in space-saving SC-70 and SOT-23-3 packages and requiring a minimum current of 45 μA (typ), the LM4040 also is ideal for portable applications. The LM4040xl is characterized for operation over an ambient temperature range of –40°C to 85°C. The LM4040xQ is characterized for operation over an ambient temperature range of –40°C to 125°C.

DBZ (SOT-23) PACKAGE
(TOP VIEW)

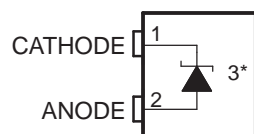

* Pin 3 is attached to substrate and must be connected to ANODE or left open.

DCK (SC-70) PACKAGE
(TOP VIEW)

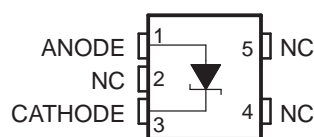

NC – No internal connection

LP (TO-92/TO-226) PACKAGE
(TOP VIEW)



NC – No internal connection



Please be aware that an important notice concerning availability, standard warranty, and use in critical applications of Texas Instruments semiconductor products and disclaimers thereto appears at the end of this data sheet.

LM4040 PRECISION MICROPOWER SHUNT VOLTAGE REFERENCE



SLOS456J – JANUARY 2005 – REVISED SEPTEMBER 2006

ORDERING INFORMATION

| T_A | DEVICE GRADE | V_{KA} | PACKAGE ⁽¹⁾ | | ORDERABLE PART NUMBER | TOP-SIDE MARKING ⁽²⁾ |
|---------------|--|--------------|------------------------|--------------|-----------------------|---------------------------------|
| -40°C to 85°C | A grade: 0.1% initial accuracy and 100 ppm/°C temperature coefficient | 2.048 V | SC-70 (DCK) | Reel of 3000 | LM4040A20IDCKR | MS_ |
| | | | | Reel of 3000 | LM4040A20IDBZR | 4MC_ |
| | | | SOT-23-3 (DBZ) | Reel of 250 | LM4040A20IDBZT | |
| | | | | Bulk of 1000 | LM4040A20ILP | PREVIEW |
| | | | TO-92/TO-226 (LP) | Reel of 2000 | LM4040A20ILPR | |
| | | | | | | |
| | | 2.5 V | SC-70 (DCK) | Reel of 3000 | LM4040A25IDCKR | P2_ |
| | | | | Reel of 3000 | LM4040A25IDBZR | 4NG_ |
| | | | SOT-23-3 (DBZ) | Reel of 250 | LM4040A25IDBZT | |
| | | | | Bulk of 1000 | LM4040A25ILP | PREVIEW |
| | | | TO-92/TO-226 (LP) | Reel of 2000 | LM4040A25ILPR | |
| | | | | | | |
| | | 3 V | SC-70 (DCK) | Reel of 3000 | LM4040A30IDCKR | P9_ |
| | | | | Reel of 3000 | LM4040A30IDBZR | 4M6_ |
| | | | SOT-23-3 (DBZ) | Reel of 250 | LM4040A30IDBZT | |
| | | | | Bulk of 1000 | LM4040A30ILP | PREVIEW |
| | | | TO-92/TO-226 (LP) | Reel of 2000 | LM4040A30ILPR | |
| | | | | | | |
| | | 4.096 V | SC-70 (DCK) | Reel of 3000 | LM4040A41IDCKR | P4_ |
| | | | | Reel of 3000 | LM4040A41IDBZR | 4M2_ |
| | | | SOT-23-3 (DBZ) | Reel of 250 | LM4040A41IDBZT | |
| | | | | Bulk of 1000 | LM4040A41ILP | PREVIEW |
| | | | TO-92/TO-226 (LP) | Reel of 2000 | LM4040A41ILPR | |
| | | | | | | |
| 5 V | SC-70 (DCK) | Reel of 3000 | LM4040A50IDCKR | N5_ | | |
| | | Reel of 3000 | LM4040A50IDBZR | 4NA_ | | |
| | SOT-23-3 (DBZ) | Reel of 250 | LM4040A50IDBZT | | | |
| | | Bulk of 1000 | LM4040A50ILP | PREVIEW | | |
| | TO-92/TO-226 (LP) | Reel of 2000 | LM4040A50ILPR | | | |
| | | | | | | |
| 8.192 V | SC-70 (DCK) | Reel of 3000 | LM4040A82IDCKR | PD_ | | |
| | | Reel of 3000 | LM4040A82IDBZR | 4NL_ | | |
| | SOT-23-3 (DBZ) | Reel of 250 | LM4040A82IDBZT | | | |
| | | Bulk of 1000 | LM4040A82ILP | PREVIEW | | |
| | TO-92/TO-226 (LP) | Reel of 2000 | LM4040A82ILPR | | | |
| | | | | | | |
| 10 V | SC-70 (DCK) | Reel of 3000 | LM4040A10IDCKR | PH_ | | |
| | | Reel of 3000 | LM4040A10IDBZR | 4NQ_ | | |
| | SOT-23-3 (DBZ) | Reel of 250 | LM4040A10IDBZT | | | |
| | | Bulk of 1000 | LM4040A10ILP | PREVIEW | | |
| | TO-92/TO-226 (LP) | Reel of 2000 | LM4040A10ILPR | | | |
| | | | | | | |

(1) Package drawings, standard packing quantities, thermal data, symbolization, and PCB design guidelines are available at www.ti.com/sc/package.

(2) DBZ/DCK: The actual top-side marking has one additional character that designates the assembly/test site.

ORDERING INFORMATION (continued)

| T_A | DEVICE GRADE | V_{KA} | PACKAGE ⁽¹⁾ | | ORDERABLE PART NUMBER | TOP-SIDE MARKING ⁽²⁾ |
|-------------------|--|-------------------|------------------------|----------------|-----------------------|---------------------------------|
| -40°C to 85°C | B grade: 0.2% initial accuracy and 100 ppm/°C temperature coefficient | 2.048 V | SC-70 (DCK) | Reel of 3000 | LM4040B20IDCKR | MT_ |
| | | | SOT-23-3 (DBZ) | Reel of 3000 | LM4040B20IDBZR | 4MD_ |
| | | | | Reel of 250 | LM4040B20IDBZT | |
| | | | TO-92/TO-226 (LP) | Bulk of 1000 | LM4040B20ILP | PREVIEW |
| | | | | Reel of 2000 | LM4040B20ILPR | |
| | | | 2.5 V | SC-70 (DCK) | Reel of 3000 | LM4040B25IDCKR |
| | | SOT-23-3 (DBZ) | | Reel of 3000 | LM4040B25IDBZR | 4NH_ |
| | | | | Reel of 250 | LM4040B25IDBZT | |
| | | TO-92/TO-226 (LP) | | Bulk of 1000 | LM4040B25ILP | PREVIEW |
| | | | | Reel of 2000 | LM4040B25ILPR | |
| | | 3 V | | SC-70 (DCK) | Reel of 3000 | LM4040B30IDCKR |
| | | | SOT-23-3 (DBZ) | Reel of 3000 | LM4040B30IDBZR | 4M7_ |
| | | | | Reel of 250 | LM4040B30IDBZT | |
| | | | TO-92/TO-226 (LP) | Bulk of 1000 | LM4040B30ILP | PREVIEW |
| | | | | Reel of 2000 | LM4040B30ILPR | |
| | | | 4.096 V | SC-70 (DCK) | Reel of 3000 | LM4040B41IDCKR |
| | | SOT-23-3 (DBZ) | | Reel of 3000 | LM4040B41IDBZR | 4M3_ |
| | | | | Reel of 250 | LM4040B41IDBZT | |
| | | TO-92/TO-226 (LP) | | Bulk of 1000 | LM4040B41ILP | PREVIEW |
| | | | | Reel of 2000 | LM4040B41ILPR | |
| | | 5 V | | SC-70 (DCK) | Reel of 3000 | LM4040B50IDCKR |
| | | | SOT-23-3 (DBZ) | Reel of 3000 | LM4040B50IDBZR | 4NB_ |
| | | | | Reel of 250 | LM4040B50IDBZT | |
| | | | TO-92/TO-226 (LP) | Bulk of 1000 | LM4040B50ILP | PREVIEW |
| Reel of 2000 | LM4040B50ILPR | | | | | |
| 8.192 V | SC-70 (DCK) | | Reel of 3000 | LM4040B82IDCKR | PE_ | |
| | SOT-23-3 (DBZ) | Reel of 3000 | LM4040B82IDBZR | 4NM_ | | |
| | | Reel of 250 | LM4040B82IDBZT | | | |
| | TO-92/TO-226 (LP) | Bulk of 1000 | LM4040B82ILP | PREVIEW | | |
| | | Reel of 2000 | LM4040B82ILPR | | | |
| | 10 V | SC-70 (DCK) | Reel of 3000 | LM4040B10IDCKR | PJ_ | |
| SOT-23-3 (DBZ) | | Reel of 3000 | LM4040B10IDBZR | 4NR_ | | |
| | | Reel of 250 | LM4040B10IDBZT | | | |
| TO-92/TO-226 (LP) | | Bulk of 1000 | LM4040B10ILP | PREVIEW | | |
| | | Reel of 2000 | LM4040B10ILPR | | | |

LM4040 PRECISION MICROPOWER SHUNT VOLTAGE REFERENCE

SLOS456J – JANUARY 2005 – REVISED SEPTEMBER 2006

ORDERING INFORMATION (continued)

| T _A | DEVICE GRADE | V _{KA} | PACKAGE ⁽¹⁾ | | ORDERABLE PART NUMBER | TOP-SIDE MARKING ⁽²⁾ |
|----------------|--|-----------------|------------------------|---------------|-----------------------|---------------------------------|
| -40°C to 85°C | C grade: 0.5% initial accuracy and 100 ppm/°C temperature coefficient | 2.048 V | SC-70 (DCK) | Reel of 3000 | LM4040C20IDCKR | MV_ |
| | | | SOT-23-3 (DBZ) | Reel of 3000 | LM4040C20IDBZR | 4MQ_ |
| | | | | Reel of 250 | LM4040C20IDBZT | |
| | | | TO-92/TO-226 (LP) | Bulk of 1000 | LM4040C20ILP | PREVIEW |
| | | Reel of 2000 | | LM4040C20ILPR | | |
| | | 2.5 V | SC-70 (DCK) | Reel of 3000 | LM4040C25IDCKR | M4_ |
| | | | SOT-23-3 (DBZ) | Reel of 3000 | LM4040C25IDBZR | 4MU_ |
| | | | | Reel of 250 | LM4040C25IDBZT | |
| | | | TO-92/TO-226 (LP) | Bulk of 1000 | LM4040C25ILP | NCF25I |
| | | Reel of 2000 | | LM4040C25ILPR | | |
| | | 3 V | SC-70 (DCK) | Reel of 3000 | LM4040C30IDCKR | PB_ |
| | | | SOT-23-3 (DBZ) | Reel of 3000 | LM4040C30IDBZR | 4M8_ |
| | | | | Reel of 250 | LM4040C30IDBZT | |
| | | | TO-92/TO-226 (LP) | Bulk of 1000 | LM4040C30ILP | PREVIEW |
| | | Reel of 2000 | | LM4040C30ILPR | | |
| | | 4.096 V | SC-70 (DCK) | Reel of 3000 | LM4040C41IDCKR | P6_ |
| | | | SOT-23-3 (DBZ) | Reel of 3000 | LM4040C41IDBZR | 4M4_ |
| | | | | Reel of 250 | LM4040C41IDBZT | |
| | | | TO-92/TO-226 (LP) | Bulk of 1000 | LM4040C41ILP | PREVIEW |
| | | Reel of 2000 | | LM4040C41ILPR | | |
| | | 5 V | SC-70 (DCK) | Reel of 3000 | LM4040C50IDCKR | MZ_ |
| | | | SOT-23-3 (DBZ) | Reel of 3000 | LM4040C50IDBZR | 4NC_ |
| | | | | Reel of 250 | LM4040C50IDBZT | |
| | | | TO-92/TO-226 (LP) | Bulk of 1000 | LM4040C50ILP | PREVIEW |
| Reel of 2000 | LM4040C50ILPR | | | | | |
| 8.192 V | SC-70 (DCK) | Reel of 3000 | LM4040C82IDCKR | PF_ | | |
| | SOT-23-3 (DBZ) | Reel of 3000 | LM4040C82IDBZR | 4NN_ | | |
| | | Reel of 250 | LM4040C82IDBZT | | | |
| | TO-92/TO-226 (LP) | Bulk of 1000 | LM4040C82ILP | PREVIEW | | |
| Reel of 2000 | | LM4040C82ILPR | | | | |
| 10 V | SC-70 (DCK) | Reel of 3000 | LM4040C10IDCKR | PK_ | | |
| | SOT-23-3 (DBZ) | Reel of 3000 | LM4040C10IDBZR | 4NS_ | | |
| | | Reel of 250 | LM4040C10IDBZT | | | |
| | TO-92/TO-226 (LP) | Bulk of 1000 | LM4040C10ILP | NFC10I | | |
| Reel of 2000 | | LM4040C10ILPR | | | | |

ORDERING INFORMATION (continued)

| T_A | DEVICE GRADE | V_{KA} | PACKAGE ⁽¹⁾ | | ORDERABLE PART NUMBER | TOP-SIDE MARKING ⁽²⁾ |
|-------------------|--|-------------------|------------------------|----------------|-----------------------|---------------------------------|
| -40°C to 85°C | D grade: 1.0% initial accuracy and 150 ppm/°C temperature coefficient | 2.048 V | SC-70 (DCK) | Reel of 3000 | LM4040D20IDCKR | MW_ |
| | | | SOT-23-3 (DBZ) | Reel of 3000 | LM4040D20IDBZR | 4MV_ |
| | | | | Reel of 250 | LM4040D20IDBZT | |
| | | | TO-92/TO-226 (LP) | Bulk of 1000 | LM4040D20ILP | PREVIEW |
| | | | | Reel of 2000 | LM4040D20ILPR | |
| | | | 2.5 V | SC-70 (DCK) | Reel of 3000 | LM4040D25IDCKR |
| | | SOT-23-3 (DBZ) | | Reel of 3000 | LM4040D25IDBZR | 4ME_ |
| | | | | Reel of 250 | LM4040D25IDBZT | |
| | | TO-92/TO-226 (LP) | | Bulk of 1000 | LM4040D25ILP | NFD25I |
| | | | | Reel of 2000 | LM4040D25ILPR | |
| | | 3 V | | SC-70 (DCK) | Reel of 3000 | LM4040D30IDCKR |
| | | | SOT-23-3 (DBZ) | Reel of 3000 | LM4040D30IDBZR | 4M9_ |
| | | | | Reel of 250 | LM4040D30IDBZT | |
| | | | TO-92/TO-226 (LP) | Bulk of 1000 | LM4040D30ILP | PREVIEW |
| | | | | Reel of 2000 | LM4040D30ILPR | |
| | | | 4.096 V | SC-70 (DCK) | Reel of 3000 | LM4040D41IDCKR |
| | | SOT-23-3 (DBZ) | | Reel of 3000 | LM4040D41IDBZR | 4M5_ |
| | | | | Reel of 250 | LM4040D41IDBZT | |
| | | TO-92/TO-226 (LP) | | Bulk of 1000 | LM4040D41ILP | PREVIEW |
| | | | | Reel of 2000 | LM4040D41ILPR | |
| | | 5 V | | SC-70 (DCK) | Reel of 3000 | LM4040D50IDCKR |
| | | | SOT-23-3 (DBZ) | Reel of 3000 | LM4040D50IDBZR | 4ND_ |
| | | | | Reel of 250 | LM4040D50IDBZT | |
| | | | TO-92/TO-226 (LP) | Bulk of 1000 | LM4040D50ILP | PREVIEW |
| Reel of 2000 | LM4040D50ILPR | | | | | |
| 8.192 V | SC-70 (DCK) | | Reel of 3000 | LM4040D82IDCKR | PG_ | |
| | SOT-23-3 (DBZ) | Reel of 3000 | LM4040D82IDBZR | 4NP_ | | |
| | | Reel of 250 | LM4040D82IDBZT | | | |
| | TO-92/TO-226 (LP) | Bulk of 1000 | LM4040D82ILP | PREVIEW | | |
| | | Reel of 2000 | LM4040D82ILPR | | | |
| | 10 V | SC-70 (DCK) | Reel of 3000 | LM4040D10IDCKR | PL_ | |
| SOT-23-3 (DBZ) | | Reel of 3000 | LM4040D10IDBZR | 4NT_ | | |
| | | Reel of 250 | LM4040D10IDBZT | | | |
| TO-92/TO-226 (LP) | | Bulk of 1000 | LM4040D10ILP | NFD10I | | |
| | | Reel of 2000 | LM4040D10ILPR | | | |

LM4040 PRECISION MICROPOWER SHUNT VOLTAGE REFERENCE

SLOS456J – JANUARY 2005 – REVISED SEPTEMBER 2006

ORDERING INFORMATION (continued)

| T _A | DEVICE GRADE | V _{KA} | PACKAGE ⁽¹⁾ | ORDERABLE PART NUMBER | TOP-SIDE MARKING ⁽²⁾ | |
|----------------|--|-----------------|------------------------|-----------------------|---------------------------------|------|
| -40°C to 125°C | C grade: 0.5% initial accuracy and 100 ppm/°C temperature coefficient | 2.048 V | SOT-23-3 (DBZ) | Reel of 3000 | LM4040C20QDBZR | 4MW_ |
| | | | | Reel of 250 | LM4040C20QDBZT | |
| | | 2.5 V | | Reel of 3000 | LM4040C25QDBZR | 4MA_ |
| | | | | Reel of 250 | LM4040C25QDBZT | |
| | | 3 V | | Reel of 3000 | LM4040C30QDBZR | 4NJ_ |
| | | | | Reel of 250 | LM4040C30QDBZT | |
| | | 5 V | | Reel of 3000 | LM4040C50QDBZR | 4NE_ |
| | | | | Reel of 250 | LM4040C50QDBZT | |
| | D grade: 1.0% initial accuracy and 150 ppm/°C temperature coefficient | 2.048 V | SOT-23-3 (DBZ) | Reel of 3000 | LM4040D20QDBZR | 4MY_ |
| | | | | Reel of 250 | LM4040D20QDBZT | |
| | | 2.5 V | | Reel of 3000 | LM4040D25QDBZR | 4MB_ |
| | | | | Reel of 250 | LM4040D25QDBZT | |
| | | 3 V | | Reel of 3000 | LM4040D30QDBZR | 4NK_ |
| | | | | Reel of 250 | LM4040D30QDBZT | |
| 5 V | | Reel of 3000 | | LM4040D50QDBZR | 4NF_ | |
| | | Reel of 250 | | LM4040D50QDBZT | | |

EEPW.com.cn

FUNCTIONAL BLOCK DIAGRAM

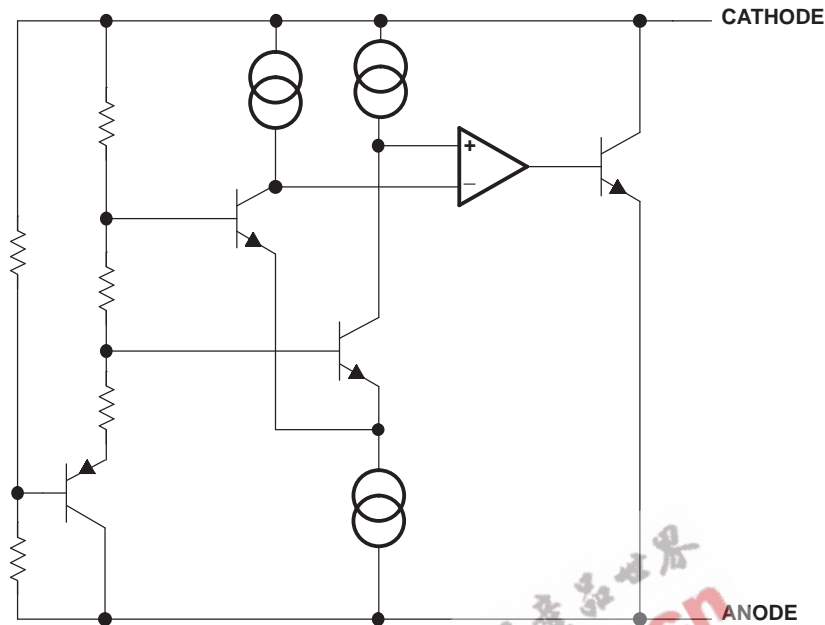

Absolute Maximum Ratings⁽¹⁾

over free-air temperature range (unless otherwise noted)

| | | MIN | MAX | UNIT |
|---------------|--|-----|-------------|------|
| I_Z | Continuous cathode current | -10 | 25 | mA |
| θ_{JA} | Package thermal impedance ^{(2) (3)} | | DBZ package | 206 |
| | | | DCK package | 252 |
| | | | LP package | 156 |
| T_J | Operating virtual junction temperature | | 150 | °C |
| T_{stg} | Storage temperature range | -65 | 150 | °C |

- (1) Stresses beyond those listed under "absolute maximum ratings" may cause permanent damage to the device. These are stress ratings only, and functional operation of the device at these or any other conditions beyond those indicated under "recommended operating conditions" is not implied. Exposure to absolute-maximum-rated conditions for extended periods may affect device reliability.
- (2) Maximum power dissipation is a function of $T_J(\text{max})$, θ_{JA} , and T_A . The maximum allowable power dissipation at any allowable ambient temperature is $P_D = (T_J(\text{max}) - T_A) / \theta_{JA}$. Operating at the absolute maximum T_J of 150°C can affect reliability.
- (3) The package thermal impedance is calculated in accordance with JESD 51-7.

Recommended Operating Conditions⁽¹⁾

| | | MIN | MAX | UNIT |
|-------|----------------------|-----|------------|---------|
| I_Z | Cathode current | (1) | 12 | mA |
| T_A | Free-air temperature | | LM4040xxxI | -40 85 |
| | | | LM4040xxxQ | -40 125 |

- (1) See parametric tables

LM4040 PRECISION MICROPOWER SHUNT VOLTAGE REFERENCE

SLOS456J – JANUARY 2005 – REVISED SEPTEMBER 2006

LM4040x20I Electrical Characteristics

at industrial temperature range, full-range $T_A = -40^\circ\text{C}$ to 85°C (unless otherwise noted)

| PARAMETER | TEST CONDITIONS | T_A | LM4040A20I | | | LM4040B20I | | | UNIT |
|---------------------------------|--|--|------------|-----|-----|--------------|-----|-----|----------------------------|
| | | | MIN | TYP | MAX | MIN | TYP | MAX | |
| V_Z | Reverse breakdown voltage | $I_Z = 100\ \mu\text{A}$ | 25°C | | | 2.048 | | | V |
| ΔV_Z | Reverse breakdown voltage tolerance | $I_Z = 100\ \mu\text{A}$ | 25°C | | | -2 2 | | | mV |
| | | | Full range | | | -15 15 | | | |
| $I_{Z,\text{min}}$ | Minimum cathode current | | 25°C | | | 45 75 | | | μA |
| | | | Full range | | | 80 | | | |
| α_{VZ} | Average temperature coefficient of reverse breakdown voltage | $I_Z = 10\ \text{mA}$ | 25°C | | | ± 20 | | | ppm/°C |
| | | $I_Z = 1\ \text{mA}$ | 25°C | | | ± 15 | | | |
| | | | Full range | | | ± 100 | | | |
| $\frac{\Delta V_Z}{\Delta I_Z}$ | Reverse breakdown voltage change with cathode current change | $I_{Z,\text{min}} < I_Z < 1\ \text{mA}$ | 25°C | | | 0.3 0.8 | | | mV |
| | | | Full range | | | 1 | | | |
| | | $1\ \text{mA} < I_Z < 15\ \text{mA}$ | 25°C | | | 2.5 6 | | | |
| | | | Full range | | | 8 | | | |
| Z_Z | Reverse dynamic impedance | $I_Z = 1\ \text{mA}$, $f = 120\ \text{Hz}$, $I_{AC} = 0.1 I_Z$ | 25°C | | | 0.3 0.8 | | | Ω |
| e_N | Wideband noise | $I_Z = 100\ \mu\text{A}$, $10\ \text{Hz} \leq f \leq 10\ \text{kHz}$ | 25°C | | | 35 | | | μV_{RMS} |
| | Long-term stability of reverse breakdown voltage | $t = 1000\ \text{h}$, $T_A = 25^\circ\text{C} \pm 0.1^\circ\text{C}$, $I_Z = 100\ \mu\text{A}$ | | | | 120 | | | ppm |
| V_{HYST} | Thermal hysteresis ⁽¹⁾ | $\Delta T_A = -40^\circ\text{C}$ to 125°C | | | | 0.08 | | | % |

(1) Thermal hysteresis is defined as $V_{Z,25^\circ\text{C}}$ (after cycling to -40°C) – $V_{Z,25^\circ\text{C}}$ (after cycling to 125°C).

LM4040x20I Electrical Characteristics

at industrial temperature range, full-range $T_A = -40^{\circ}\text{C}$ to 85°C (unless otherwise noted)

| PARAMETER | TEST CONDITIONS | T_A | LM4040C20I | | | LM4040D20I | | | UNIT |
|---------------------------------|--|--|------------|-----|-----|--------------|-----|-----|----------------------------|
| | | | MIN | TYP | MAX | MIN | TYP | MAX | |
| V_Z | Reverse breakdown voltage | $I_Z = 100\ \mu\text{A}$ | 25°C | | | 2.048 | | | V |
| ΔV_Z | Reverse breakdown voltage tolerance | $I_Z = 100\ \mu\text{A}$ | 25°C | | | -10 10 | | | mV |
| | | | Full range | | | -23 23 | | | |
| $I_{Z,\text{min}}$ | Minimum cathode current | | 25°C | | | 45 75 | | | μA |
| | | | Full range | | | 80 | | | |
| α_{VZ} | Average temperature coefficient of reverse breakdown voltage | $I_Z = 10\ \text{mA}$ | 25°C | | | ± 20 | | | ppm/°C |
| | | $I_Z = 1\ \text{mA}$ | 25°C | | | ± 15 | | | |
| | | | Full range | | | ± 100 | | | |
| $\frac{\Delta V_Z}{\Delta I_Z}$ | Reverse breakdown voltage change with cathode current change | $I_{Z,\text{min}} < I_Z < 1\ \text{mA}$ | 25°C | | | 0.3 0.8 | | | mV |
| | | | Full range | | | 1 1.2 | | | |
| | | $1\ \text{mA} < I_Z < 15\ \text{mA}$ | 25°C | | | 2.5 6 | | | |
| | | | Full range | | | 8 10 | | | |
| Z_Z | Reverse dynamic impedance | $I_Z = 1\ \text{mA}$, $f = 120\ \text{Hz}$, $I_{\text{AC}} = 0.1 I_Z$ | 25°C | | | 0.3 0.9 | | | Ω |
| e_N | Wideband noise | $I_Z = 100\ \mu\text{A}$, $10\ \text{Hz} \leq f \leq 10\ \text{kHz}$ | 25°C | | | 35 | | | μV_{RMS} |
| | Long-term stability of reverse breakdown voltage | $t = 1000\ \text{h}$, $T_A = 25^{\circ}\text{C} \pm 0.1^{\circ}\text{C}$, $I_Z = 100\ \mu\text{A}$ | | | | 120 | | | ppm |
| V_{HYST} | Thermal hysteresis ⁽¹⁾ | $\Delta T_A = -40^{\circ}\text{C}$ to 125°C | | | | 0.08 | | | % |

(1) Thermal hysteresis is defined as $V_{Z,25^{\circ}\text{C}}$ (after cycling to -40°C) – $V_{Z,25^{\circ}\text{C}}$ (after cycling to 125°C).

LM4040 PRECISION MICROPOWER SHUNT VOLTAGE REFERENCE

SLOS456J – JANUARY 2005 – REVISED SEPTEMBER 2006

LM4040x20Q Electrical Characteristics

at extended temperature range, full-range $T_A = -40^\circ\text{C}$ to 125°C (unless otherwise noted)

| PARAMETER | TEST CONDITIONS | T_A | LM4040C20Q | | | LM4040D20Q | | | UNIT |
|---------------------------------|--|--|------------|-----|-----|--------------|-----|-----|----------------------------|
| | | | MIN | TYP | MAX | MIN | TYP | MAX | |
| V_Z | Reverse breakdown voltage | $I_Z = 100\ \mu\text{A}$ | 25°C | | | 2.048 | | | V |
| ΔV_Z | Reverse breakdown voltage tolerance | $I_Z = 100\ \mu\text{A}$ | 25°C | | | -10 10 | | | mV |
| | | | Full range | | | -30 30 | | | |
| $I_{Z,\text{min}}$ | Minimum cathode current | | 25°C | | | 45 75 | | | μA |
| | | | Full range | | | 80 | | | |
| α_{VZ} | Average temperature coefficient of reverse breakdown voltage | $I_Z = 10\ \text{mA}$ | 25°C | | | ± 20 | | | ppm/°C |
| | | $I_Z = 1\ \text{mA}$ | 25°C | | | ± 15 | | | |
| | | | Full range | | | ± 100 | | | |
| $\frac{\Delta V_Z}{\Delta I_Z}$ | Reverse breakdown voltage change with cathode current change | $I_{Z,\text{min}} < I_Z < 1\ \text{mA}$ | 25°C | | | 0.3 0.8 | | | mV |
| | | | Full range | | | 1 1.2 | | | |
| | | $1\ \text{mA} < I_Z < 15\ \text{mA}$ | 25°C | | | 2.5 6 | | | |
| | | | Full range | | | 8 10 | | | |
| Z_Z | Reverse dynamic impedance | $I_Z = 1\ \text{mA}$, $f = 120\ \text{Hz}$, $I_{\text{AC}} = 0.1 I_Z$ | 25°C | | | 0.3 0.9 | | | Ω |
| e_N | Wideband noise | $I_Z = 100\ \mu\text{A}$, $10\ \text{Hz} \leq f \leq 10\ \text{kHz}$ | 25°C | | | 35 | | | μV_{RMS} |
| | Long-term stability of reverse breakdown voltage | $t = 1000\ \text{h}$, $T_A = 25^\circ\text{C} \pm 0.1^\circ\text{C}$, $I_Z = 100\ \mu\text{A}$ | | | | 120 | | | ppm |
| V_{HYST} | Thermal hysteresis ⁽¹⁾ | $\Delta T_A = -40^\circ\text{C}$ to 125°C | | | | 0.08 | | | % |

(1) Thermal hysteresis is defined as $V_{Z,25^\circ\text{C}}$ (after cycling to -40°C) – $V_{Z,25^\circ\text{C}}$ (after cycling to 125°C).

LM4040x25I Electrical Characteristics

at industrial temperature range, full-range $T_A = -40^{\circ}\text{C}$ to 85°C (unless otherwise noted)

| PARAMETER | TEST CONDITIONS | T_A | LM4040A25I | | | LM4040B25I | | | UNIT |
|---------------------------------|--|--|-----------------------|-----|-----|---------------|-----|-----|----------------------------|
| | | | MIN | TYP | MAX | MIN | TYP | MAX | |
| V_Z | Reverse breakdown voltage | $I_Z = 100\ \mu\text{A}$ | 25 $^{\circ}\text{C}$ | | | 2.5 | | | V |
| ΔV_Z | Reverse breakdown voltage tolerance | $I_Z = 100\ \mu\text{A}$ | 25 $^{\circ}\text{C}$ | | | -2.5 2.5 | | | mV |
| | | | Full range | | | -19 19 | | | |
| $I_{Z,\text{min}}$ | Minimum cathode current | | 25 $^{\circ}\text{C}$ | | | 45 75 | | | μA |
| | | | Full range | | | 80 | | | |
| α_{VZ} | Average temperature coefficient of reverse breakdown voltage | $I_Z = 10\ \text{mA}$ | 25 $^{\circ}\text{C}$ | | | ± 20 | | | ppm/ $^{\circ}\text{C}$ |
| | | $I_Z = 1\ \text{mA}$ | 25 $^{\circ}\text{C}$ | | | ± 15 | | | |
| | | | Full range | | | ± 100 | | | |
| $\frac{\Delta V_Z}{\Delta I_Z}$ | Reverse breakdown voltage change with cathode current change | $I_{Z,\text{min}} < I_Z < 1\ \text{mA}$ | 25 $^{\circ}\text{C}$ | | | 0.3 0.8 | | | mV |
| | | | Full range | | | 1 | | | |
| | | $1\ \text{mA} < I_Z < 15\ \text{mA}$ | 25 $^{\circ}\text{C}$ | | | 2.5 6 | | | |
| | | | Full range | | | 8 | | | |
| Z_Z | Reverse dynamic impedance | $I_Z = 1\ \text{mA}$, $f = 120\ \text{Hz}$, $I_{\text{AC}} = 0.1 I_Z$ | 25 $^{\circ}\text{C}$ | | | 0.3 0.8 | | | Ω |
| e_N | Wideband noise | $I_Z = 100\ \mu\text{A}$, $10\ \text{Hz} \leq f \leq 10\ \text{kHz}$ | 25 $^{\circ}\text{C}$ | | | 35 | | | μV_{RMS} |
| | Long-term stability of reverse breakdown voltage | $t = 1000\ \text{h}$, $T_A = 25^{\circ}\text{C} \pm 0.1^{\circ}\text{C}$, $I_Z = 100\ \mu\text{A}$ | | | | 120 | | | ppm |
| V_{HYST} | Thermal hysteresis ⁽¹⁾ | $\Delta T_A = -40^{\circ}\text{C}$ to 125°C | | | | 0.08 | | | % |

(1) Thermal hysteresis is defined as $V_{Z,25^{\circ}\text{C}}$ (after cycling to -40°C) $- V_{Z,25^{\circ}\text{C}}$ (after cycling to 125°C).

LM4040 PRECISION MICROPOWER SHUNT VOLTAGE REFERENCE

SLOS456J – JANUARY 2005 – REVISED SEPTEMBER 2006

LM4040x25I Electrical Characteristics

at industrial temperature range, full-range $T_A = -40^{\circ}\text{C}$ to 85°C (unless otherwise noted)

| PARAMETER | TEST CONDITIONS | T_A | LM4040C25I | | | LM4040D25I | | | UNIT |
|---------------------------------|--|--|-----------------------|-----|-----|--------------|-----|-----|----------------------------|
| | | | MIN | TYP | MAX | MIN | TYP | MAX | |
| V_Z | Reverse breakdown voltage | $I_Z = 100\ \mu\text{A}$ | 25 $^{\circ}\text{C}$ | | | 2.5 | | | V |
| ΔV_Z | Reverse breakdown voltage tolerance | $I_Z = 100\ \mu\text{A}$ | 25 $^{\circ}\text{C}$ | | | -12 12 | | | mV |
| | | | Full range | | | -29 29 | | | |
| $I_{Z,\text{min}}$ | Minimum cathode current | | 25 $^{\circ}\text{C}$ | | | 45 75 | | | μA |
| | | | Full range | | | 80 | | | |
| α_{VZ} | Average temperature coefficient of reverse breakdown voltage | $I_Z = 10\ \text{mA}$ | 25 $^{\circ}\text{C}$ | | | ± 20 | | | ppm/ $^{\circ}\text{C}$ |
| | | $I_Z = 1\ \text{mA}$ | 25 $^{\circ}\text{C}$ | | | ± 15 | | | |
| | | | Full range | | | ± 100 | | | |
| $\frac{\Delta V_Z}{\Delta I_Z}$ | Reverse breakdown voltage change with cathode current change | $I_{Z,\text{min}} < I_Z < 1\ \text{mA}$ | 25 $^{\circ}\text{C}$ | | | 0.3 0.8 | | | mV |
| | | | Full range | | | 1 1.2 | | | |
| | | $1\ \text{mA} < I_Z < 15\ \text{mA}$ | 25 $^{\circ}\text{C}$ | | | 2.5 6 | | | |
| | | | Full range | | | 8 10 | | | |
| Z_Z | Reverse dynamic impedance | $I_Z = 1\ \text{mA}$, $f = 120\ \text{Hz}$, $I_{\text{AC}} = 0.1 I_Z$ | 25 $^{\circ}\text{C}$ | | | 0.3 0.9 | | | Ω |
| e_N | Wideband noise | $I_Z = 100\ \mu\text{A}$, $10\ \text{Hz} \leq f \leq 10\ \text{kHz}$ | 25 $^{\circ}\text{C}$ | | | 35 | | | μV_{RMS} |
| | Long-term stability of reverse breakdown voltage | $t = 1000\ \text{h}$, $T_A = 25^{\circ}\text{C} \pm 0.1^{\circ}\text{C}$, $I_Z = 100\ \mu\text{A}$ | | | | 120 | | | ppm |
| V_{HYST} | Thermal hysteresis ⁽¹⁾ | $\Delta T_A = -40^{\circ}\text{C}$ to 125°C | | | | 0.08 | | | % |

(1) Thermal hysteresis is defined as $V_{Z,25^{\circ}\text{C}}$ (after cycling to -40°C) $- V_{Z,25^{\circ}\text{C}}$ (after cycling to 125°C).

LM4040x25Q Electrical Characteristics

at extended temperature range, full-range $T_A = -40^\circ\text{C}$ to 125°C (unless otherwise noted)

| PARAMETER | TEST CONDITIONS | T_A | LM4040C25Q | | | LM4040D25Q | | | UNIT |
|---------------------------------|--|--|------------|-----|-----|--------------|-----|-----|----------------------------|
| | | | MIN | TYP | MAX | MIN | TYP | MAX | |
| V_Z | Reverse breakdown voltage | $I_Z = 100\ \mu\text{A}$ | 25°C | | | 2.5 | | | V |
| ΔV_Z | Reverse breakdown voltage tolerance | $I_Z = 100\ \mu\text{A}$ | 25°C | | | -12 12 | | | mV |
| | | | Full range | | | -38 38 | | | |
| $I_{Z,\text{min}}$ | Minimum cathode current | | 25°C | | | 45 75 | | | μA |
| | | | Full range | | | 80 | | | |
| α_{VZ} | Average temperature coefficient of reverse breakdown voltage | $I_Z = 10\ \text{mA}$ | 25°C | | | ± 20 | | | ppm/°C |
| | | $I_Z = 1\ \text{mA}$ | 25°C | | | ± 15 | | | |
| | | | Full range | | | ± 100 | | | |
| $\frac{\Delta V_Z}{\Delta I_Z}$ | Reverse breakdown voltage change with cathode current change | $I_{Z,\text{min}} < I_Z < 1\ \text{mA}$ | 25°C | | | 0.3 0.8 | | | mV |
| | | | Full range | | | 1 1.2 | | | |
| | | $1\ \text{mA} < I_Z < 15\ \text{mA}$ | 25°C | | | 2.5 6 | | | |
| | | | Full range | | | 8 10 | | | |
| Z_Z | Reverse dynamic impedance | $I_Z = 1\ \text{mA}$, $f = 120\ \text{Hz}$, $I_{\text{AC}} = 0.1 I_Z$ | 25°C | | | 0.3 0.9 | | | Ω |
| e_N | Wideband noise | $I_Z = 100\ \mu\text{A}$, $10\ \text{Hz} \leq f \leq 10\ \text{kHz}$ | 25°C | | | 35 | | | μV_{RMS} |
| | Long-term stability of reverse breakdown voltage | $t = 1000\ \text{h}$, $T_A = 25^\circ\text{C} \pm 0.1^\circ\text{C}$, $I_Z = 100\ \mu\text{A}$ | | | | 120 | | | ppm |
| V_{HYST} | Thermal hysteresis ⁽¹⁾ | $\Delta T_A = -40^\circ\text{C}$ to 125°C | | | | 0.08 | | | % |

(1) Thermal hysteresis is defined as $V_{Z,25^\circ\text{C}}$ (after cycling to -40°C) $- V_{Z,25^\circ\text{C}}$ (after cycling to 125°C).

LM4040 PRECISION MICROPOWER SHUNT VOLTAGE REFERENCE

SLOS456J – JANUARY 2005 – REVISED SEPTEMBER 2006

LM4040x30I Electrical Characteristics

at industrial temperature range, full-range $T_A = -40^{\circ}\text{C}$ to 85°C (unless otherwise noted)

| PARAMETER | TEST CONDITIONS | T_A | LM4040A30I | | | LM4040B30I | | | UNIT | |
|---------------------------------|--|--|------------|-----|-----|------------|-----|------|---------------|----------------------------|
| | | | MIN | TYP | MAX | MIN | TYP | MAX | | |
| V_Z | Reverse breakdown voltage | $I_Z = 100\ \mu\text{A}$ | 25°C | | | 3 | | | V | |
| ΔV_Z | Reverse breakdown voltage tolerance | $I_Z = 100\ \mu\text{A}$ | 25°C | | | -3 | | | mV | |
| | | | Full range | | | -22 | | | | |
| $I_{Z,\text{min}}$ | Minimum cathode current | | 25°C | | | 47 | | | μA | |
| | | | Full range | | | 82 | | | | |
| α_{VZ} | Average temperature coefficient of reverse breakdown voltage | $I_Z = 10\ \text{mA}$ | 25°C | | | ± 20 | | | ppm/°C | |
| | | $I_Z = 1\ \text{mA}$ | 25°C | | | ± 15 | | | | |
| | | | Full range | | | ± 100 | | | | |
| $\frac{\Delta V_Z}{\Delta I_Z}$ | Reverse breakdown voltage change with cathode current change | $I_{Z,\text{min}} < I_Z < 1\ \text{mA}$ | 25°C | | | 0.6 | | 0.8 | | mV |
| | | | Full range | | | 1.1 | | 1.1 | | |
| | | $1\ \text{mA} < I_Z < 15\ \text{mA}$ | 25°C | | | 2.7 | | 6 | | |
| | | | Full range | | | 9 | | 9 | | |
| Z_Z | Reverse dynamic impedance | $I_Z = 1\ \text{mA}$, $f = 120\ \text{Hz}$, $I_{\text{AC}} = 0.1 I_Z$ | 25°C | | | 0.4 | | 0.9 | | Ω |
| e_N | Wideband noise | $I_Z = 100\ \mu\text{A}$, $10\ \text{Hz} \leq f \leq 10\ \text{kHz}$ | 25°C | | | 35 | | 35 | | μV_{RMS} |
| | Long-term stability of reverse breakdown voltage | $t = 1000\ \text{h}$, $T_A = 25^{\circ}\text{C} \pm 0.1^{\circ}\text{C}$, $I_Z = 100\ \mu\text{A}$ | | | | 120 | | 120 | | ppm |
| V_{HYST} | Thermal hysteresis ⁽¹⁾ | $\Delta T_A = -40^{\circ}\text{C}$ to 125°C | | | | 0.08 | | 0.08 | | % |

(1) Thermal hysteresis is defined as $V_{Z,25^{\circ}\text{C}}$ (after cycling to -40°C) – $V_{Z,25^{\circ}\text{C}}$ (after cycling to 125°C).

LM4040x30I Electrical Characteristics

at industrial temperature range, full-range $T_A = -40^{\circ}\text{C}$ to 85°C (unless otherwise noted)

| PARAMETER | TEST CONDITIONS | T_A | LM4040C30I | | | LM4040D30I | | | UNIT |
|---------------------------------|--|--|------------|-----|-----|--------------------------------|-----|-----|----------------------------|
| | | | MIN | TYP | MAX | MIN | TYP | MAX | |
| V_Z | Reverse breakdown voltage | $I_Z = 100\ \mu\text{A}$ | 25°C | | | 3 | | | V |
| ΔV_Z | Reverse breakdown voltage tolerance | $I_Z = 100\ \mu\text{A}$ | 25°C | | | -15 15 | | | mV |
| | | | Full range | | | -34 34 | | | |
| $I_{Z,\text{min}}$ | Minimum cathode current | | 25°C | | | 45 77 | | | μA |
| | | | Full range | | | 82 | | | |
| α_{VZ} | Average temperature coefficient of reverse breakdown voltage | $I_Z = 10\ \text{mA}$ | 25°C | | | ± 20 | | | ppm/°C |
| | | $I_Z = 1\ \text{mA}$ | 25°C | | | ± 15 | | | |
| | | | Full range | | | ± 100 | | | |
| $\frac{\Delta V_Z}{\Delta I_Z}$ | Reverse breakdown voltage change with cathode current change | $I_{Z,\text{min}} < I_Z < 1\ \text{mA}$ | 25°C | | | 0.4 0.8 1.4 1 | | | mV |
| | | | Full range | | | 1.1 1.3 | | | |
| | | $1\ \text{mA} < I_Z < 15\ \text{mA}$ | 25°C | | | 2.7 6 2.7 8 | | | |
| | | | Full range | | | 9 11 | | | |
| Z_Z | Reverse dynamic impedance | $I_Z = 1\ \text{mA}$, $f = 120\ \text{Hz}$, $I_{\text{AC}} = 0.1 I_Z$ | 25°C | | | 0.4 0.9 0.4 1.2 | | | Ω |
| e_N | Wideband noise | $I_Z = 100\ \mu\text{A}$, $10\ \text{Hz} \leq f \leq 10\ \text{kHz}$ | 25°C | | | 35 35 | | | μV_{RMS} |
| | Long-term stability of reverse breakdown voltage | $t = 1000\ \text{h}$, $T_A = 25^{\circ}\text{C} \pm 0.1^{\circ}\text{C}$, $I_Z = 100\ \mu\text{A}$ | | | | 120 120 | | | ppm |
| V_{HYST} | Thermal hysteresis ⁽¹⁾ | $\Delta T_A = -40^{\circ}\text{C}$ to 125°C | | | | 0.08 0.08 | | | % |

(1) Thermal hysteresis is defined as $V_{Z,25^{\circ}\text{C}}$ (after cycling to -40°C) – $V_{Z,25^{\circ}\text{C}}$ (after cycling to 125°C).

LM4040 PRECISION MICROPOWER SHUNT VOLTAGE REFERENCE

SLOS456J – JANUARY 2005 – REVISED SEPTEMBER 2006

LM4040x30Q Electrical Characteristics

at extended temperature range, full-range $T_A = -40^\circ\text{C}$ to 125°C (unless otherwise noted)

| PARAMETER | TEST CONDITIONS | T_A | LM4040C30Q | | | LM4040D30Q | | | UNIT |
|---------------------------------|--|--|------------|-----|-----|--------------|-----|-----|----------------------------|
| | | | MIN | TYP | MAX | MIN | TYP | MAX | |
| V_Z | Reverse breakdown voltage | $I_Z = 100\ \mu\text{A}$ | 25°C | | | 3 | | | V |
| ΔV_Z | Reverse breakdown voltage tolerance | $I_Z = 100\ \mu\text{A}$ | 25°C | | | -15 15 | | | mV |
| | | | Full range | | | -45 45 | | | |
| $I_{Z,\text{min}}$ | Minimum cathode current | | 25°C | | | 47 77 | | | μA |
| | | | Full range | | | 82 | | | |
| α_{VZ} | Average temperature coefficient of reverse breakdown voltage | $I_Z = 10\ \text{mA}$ | 25°C | | | ± 20 | | | ppm/°C |
| | | $I_Z = 1\ \text{mA}$ | 25°C | | | ± 15 | | | |
| | | | Full range | | | ± 100 | | | |
| $\frac{\Delta V_Z}{\Delta I_Z}$ | Reverse breakdown voltage change with cathode current change | $I_{Z,\text{min}} < I_Z < 1\ \text{mA}$ | 25°C | | | 0.4 0.8 | | | mV |
| | | | Full range | | | 1.1 | | | |
| | | $1\ \text{mA} < I_Z < 15\ \text{mA}$ | 25°C | | | 2.7 6 | | | |
| | | | Full range | | | 9 | | | |
| Z_Z | Reverse dynamic impedance | $I_Z = 1\ \text{mA}$, $f = 120\ \text{Hz}$, $I_{\text{AC}} = 0.1 I_Z$ | 25°C | | | 0.4 0.9 | | | Ω |
| e_N | Wideband noise | $I_Z = 100\ \mu\text{A}$, $10\ \text{Hz} \leq f \leq 10\ \text{kHz}$ | 25°C | | | 35 | | | μV_{RMS} |
| | Long-term stability of reverse breakdown voltage | $t = 1000\ \text{h}$, $T_A = 25^\circ\text{C} \pm 0.1^\circ\text{C}$, $I_Z = 100\ \mu\text{A}$ | | | | 120 | | | ppm |
| V_{HYST} | Thermal hysteresis ⁽¹⁾ | $\Delta T_A = -40^\circ\text{C}$ to 125°C | | | | 0.08 | | | % |

(1) Thermal hysteresis is defined as $V_{Z,25^\circ\text{C}}$ (after cycling to -40°C) – $V_{Z,25^\circ\text{C}}$ (after cycling to 125°C).

LM4040x41I Electrical Characteristics

at industrial temperature range, full-range $T_A = -40^{\circ}\text{C}$ to 85°C (unless otherwise noted)

| PARAMETER | TEST CONDITIONS | T_A | LM4040A41I | | | LM4040B41I | | | UNIT | |
|---------------------------------|--|--|------------|-----|-----|------------|-----|------|----------------------------|---------------|
| | | | MIN | TYP | MAX | MIN | TYP | MAX | | |
| V_Z | Reverse breakdown voltage | $I_Z = 100\ \mu\text{A}$ | 25°C | | | 4.096 | | | V | |
| ΔV_Z | Reverse breakdown voltage tolerance | $I_Z = 100\ \mu\text{A}$ | 25°C | | | -4.1 | | | 4.1 | mV |
| | | | Full range | | | -31 | | | 31 | |
| $I_{Z,\text{min}}$ | Minimum cathode current | | 25°C | | | 50 | | | 83 | μA |
| | | | Full range | | | | | | 88 | |
| α_{VZ} | Average temperature coefficient of reverse breakdown voltage | $I_Z = 10\ \text{mA}$ | 25°C | | | ± 30 | | | ppm/°C | |
| | | $I_Z = 1\ \text{mA}$ | 25°C | | | ± 20 | | | | |
| | | | Full range | | | ± 100 | | | | |
| $\frac{\Delta V_Z}{\Delta I_Z}$ | Reverse breakdown voltage change with cathode current change | $I_{Z,\text{min}} < I_Z < 1\ \text{mA}$ | 25°C | | | 0.5 | | 0.9 | mV | |
| | | | Full range | | | | | 1.2 | | |
| | | $1\ \text{mA} < I_Z < 15\ \text{mA}$ | 25°C | | | 3 | | 7 | | |
| | | | Full range | | | | | 10 | | |
| Z_Z | Reverse dynamic impedance | $I_Z = 1\ \text{mA}$, $f = 120\ \text{Hz}$, $I_{\text{AC}} = 0.1\ I_Z$ | 25°C | | | 0.5 | | 1 | Ω | |
| e_N | Wideband noise | $I_Z = 100\ \mu\text{A}$, $10\ \text{Hz} \leq f \leq 10\ \text{kHz}$ | 25°C | | | 80 | | 80 | μV_{RMS} | |
| | Long-term stability of reverse breakdown voltage | $t = 1000\ \text{h}$, $T_A = 25^{\circ}\text{C} \pm 0.1^{\circ}\text{C}$, $I_Z = 100\ \mu\text{A}$ | | | | 120 | | 120 | ppm | |
| V_{HYST} | Thermal hysteresis ⁽¹⁾ | $\Delta T_A = -40^{\circ}\text{C}$ to 125°C | | | | 0.08 | | 0.08 | % | |

(1) Thermal hysteresis is defined as $V_{Z,25^{\circ}\text{C}}$ (after cycling to -40°C) $- V_{Z,25^{\circ}\text{C}}$ (after cycling to 125°C).

LM4040 PRECISION MICROPOWER SHUNT VOLTAGE REFERENCE

SLOS456J – JANUARY 2005 – REVISED SEPTEMBER 2006

LM4040x41I Electrical Characteristics

at industrial temperature range, full-range $T_A = -40^\circ\text{C}$ to 85°C (unless otherwise noted)

| PARAMETER | TEST CONDITIONS | T_A | LM4040C41I | | | LM4040D41I | | | UNIT |
|---------------------------------|--|--|------------|-----|-----|--------------------------------|-----|-----|----------------------------|
| | | | MIN | TYP | MAX | MIN | TYP | MAX | |
| V_Z | Reverse breakdown voltage | $I_Z = 100\ \mu\text{A}$ | 25°C | | | 4.096 | | | V |
| ΔV_Z | Reverse breakdown voltage tolerance | $I_Z = 100\ \mu\text{A}$ | 25°C | | | -20 20 | | | mV |
| | | | Full range | | | -47 47 | | | |
| $I_{Z,\text{min}}$ | Minimum cathode current | | 25°C | | | 50 83 | | | μA |
| | | | Full range | | | 88 | | | |
| α_{VZ} | Average temperature coefficient of reverse breakdown voltage | $I_Z = 10\ \text{mA}$ | 25°C | | | ± 30 | | | ppm/°C |
| | | $I_Z = 1\ \text{mA}$ | 25°C | | | ± 20 | | | |
| | | | Full range | | | ± 100 | | | |
| $\frac{\Delta V_Z}{\Delta I_Z}$ | Reverse breakdown voltage change with cathode current change | $I_{Z,\text{min}} < I_Z < 1\ \text{mA}$ | 25°C | | | 0.5 0.9 0.5 1.2 | | | mV |
| | | | Full range | | | 1.2 1.5 | | | |
| | | $1\ \text{mA} < I_Z < 15\ \text{mA}$ | 25°C | | | 3 7 3 9 | | | |
| | | | Full range | | | 10 13 | | | |
| Z_Z | Reverse dynamic impedance | $I_Z = 1\ \text{mA}$, $f = 120\ \text{Hz}$, $I_{AC} = 0.1\ I_Z$ | 25°C | | | 0.5 1 0.5 1.3 | | | Ω |
| e_N | Wideband noise | $I_Z = 100\ \mu\text{A}$, $10\ \text{Hz} \leq f \leq 10\ \text{kHz}$ | 25°C | | | 80 80 | | | μV_{RMS} |
| | Long-term stability of reverse breakdown voltage | $t = 1000\ \text{h}$, $T_A = 25^\circ\text{C} \pm 0.1^\circ\text{C}$, $I_Z = 100\ \mu\text{A}$ | | | | 120 120 | | | ppm |
| V_{HYST} | Thermal hysteresis ⁽¹⁾ | $\Delta T_A = -40^\circ\text{C}$ to 125°C | | | | 0.08 0.08 | | | % |

(1) Thermal hysteresis is defined as $V_{Z,25^\circ\text{C}}$ (after cycling to -40°C) – $V_{Z,25^\circ\text{C}}$ (after cycling to 125°C).

LM4040x50I Electrical Characteristics

at industrial temperature range, full-range $T_A = -40^{\circ}\text{C}$ to 85°C (unless otherwise noted)

| PARAMETER | TEST CONDITIONS | T_A | LM4040A50I | | | LM4040B50I | | | UNIT |
|---------------------------------|--|--|------------|-----|-----|--------------|-----|-----|----------------------------|
| | | | MIN | TYP | MAX | MIN | TYP | MAX | |
| V_Z | Reverse breakdown voltage | $I_Z = 100\ \mu\text{A}$ | 25°C | | | 5 | | | V |
| ΔV_Z | Reverse breakdown voltage tolerance | $I_Z = 100\ \mu\text{A}$ | 25°C | | | -5 5 | | | mV |
| | | | Full range | | | -38 38 | | | |
| $I_{Z,\text{min}}$ | Minimum cathode current | | 25°C | | | 65 89 | | | μA |
| | | | Full range | | | 95 | | | |
| α_{VZ} | Average temperature coefficient of reverse breakdown voltage | $I_Z = 10\ \text{mA}$ | 25°C | | | ± 30 | | | ppm/°C |
| | | $I_Z = 1\ \text{mA}$ | 25°C | | | ± 20 | | | |
| | | | Full range | | | ± 100 | | | |
| $\frac{\Delta V_Z}{\Delta I_Z}$ | Reverse breakdown voltage change with cathode current change | $I_{Z,\text{min}} < I_Z < 1\ \text{mA}$ | 25°C | | | 0.5 1 | | | mV |
| | | | Full range | | | 1.4 | | | |
| | | $1\ \text{mA} < I_Z < 15\ \text{mA}$ | 25°C | | | 3.5 8 | | | |
| | | | Full range | | | 12 | | | |
| Z_Z | Reverse dynamic impedance | $I_Z = 1\ \text{mA}$, $f = 120\ \text{Hz}$, $I_{\text{AC}} = 0.1 I_Z$ | 25°C | | | 0.5 1.1 | | | Ω |
| e_N | Wideband noise | $I_Z = 100\ \mu\text{A}$, $10\ \text{Hz} \leq f \leq 10\ \text{kHz}$ | 25°C | | | 80 | | | μV_{RMS} |
| | Long-term stability of reverse breakdown voltage | $t = 1000\ \text{h}$, $T_A = 25^{\circ}\text{C} \pm 0.1^{\circ}\text{C}$, $I_Z = 100\ \mu\text{A}$ | | | | 120 | | | ppm |
| V_{HYST} | Thermal hysteresis ⁽¹⁾ | $\Delta T_A = -40^{\circ}\text{C}$ to 125°C | | | | 0.08 | | | % |

(1) Thermal hysteresis is defined as $V_{Z,25^{\circ}\text{C}}$ (after cycling to -40°C) $- V_{Z,25^{\circ}\text{C}}$ (after cycling to 125°C).

LM4040 PRECISION MICROPOWER SHUNT VOLTAGE REFERENCE

SLOS456J – JANUARY 2005 – REVISED SEPTEMBER 2006

LM4040x50I Electrical Characteristics

at industrial temperature range, full-range $T_A = -40^\circ\text{C}$ to 85°C (unless otherwise noted)

| PARAMETER | TEST CONDITIONS | T_A | LM4040C50I | | | LM4040D50I | | | UNIT |
|---------------------------------|--|--|------------|-----|-----|--------------------------------|-----|-----|----------------------------|
| | | | MIN | TYP | MAX | MIN | TYP | MAX | |
| V_Z | Reverse breakdown voltage | $I_Z = 100\ \mu\text{A}$ | 25°C | | | 5 | | | V |
| ΔV_Z | Reverse breakdown voltage tolerance | $I_Z = 100\ \mu\text{A}$ | 25°C | | | -25 25 | | | mV |
| | | | Full range | | | -58 58 | | | |
| $I_{Z,\text{min}}$ | Minimum cathode current | | 25°C | | | 65 89 | | | μA |
| | | | Full range | | | 95 | | | |
| α_{VZ} | Average temperature coefficient of reverse breakdown voltage | $I_Z = 10\ \text{mA}$ | 25°C | | | ± 30 | | | ppm/°C |
| | | $I_Z = 1\ \text{mA}$ | 25°C | | | ± 20 | | | |
| | | | Full range | | | ± 100 | | | |
| $\frac{\Delta V_Z}{\Delta I_Z}$ | Reverse breakdown voltage change with cathode current change | $I_{Z,\text{min}} < I_Z < 1\ \text{mA}$ | 25°C | | | 0.5 1 0.5 1.3 | | | mV |
| | | | Full range | | | 1.4 1.8 | | | |
| | | $1\ \text{mA} < I_Z < 15\ \text{mA}$ | 25°C | | | 3.5 8 3.5 10 | | | |
| | | | Full range | | | 12 15 | | | |
| Z_Z | Reverse dynamic impedance | $I_Z = 1\ \text{mA}$, $f = 120\ \text{Hz}$, $I_{AC} = 0.1\ I_Z$ | 25°C | | | 0.5 1.1 0.5 1.5 | | | Ω |
| e_N | Wideband noise | $I_Z = 100\ \mu\text{A}$, $10\ \text{Hz} \leq f \leq 10\ \text{kHz}$ | 25°C | | | 80 80 | | | μV_{RMS} |
| | Long-term stability of reverse breakdown voltage | $t = 1000\ \text{h}$, $T_A = 25^\circ\text{C} \pm 0.1^\circ\text{C}$, $I_Z = 100\ \mu\text{A}$ | | | | 120 120 | | | ppm |
| V_{HYST} | Thermal hysteresis ⁽¹⁾ | $\Delta T_A = -40^\circ\text{C}$ to 125°C | | | | 0.08 0.08 | | | % |

(1) Thermal hysteresis is defined as $V_{Z,25^\circ\text{C}}$ (after cycling to -40°C) – $V_{Z,25^\circ\text{C}}$ (after cycling to 125°C).

LM4040x50Q Electrical Characteristics

at extended temperature range, full-range $T_A = -40^\circ\text{C}$ to 125°C (unless otherwise noted)

| PARAMETER | TEST CONDITIONS | T_A | LM4040C50Q | | | LM4040D50Q | | | UNIT |
|---------------------------------|--|--|------------|-----|-----|--------------|-----|-----|----------------------------|
| | | | MIN | TYP | MAX | MIN | TYP | MAX | |
| V_Z | Reverse breakdown voltage | $I_Z = 100\ \mu\text{A}$ | 25°C | | | 5 | | | V |
| ΔV_Z | Reverse breakdown voltage tolerance | $I_Z = 100\ \mu\text{A}$ | 25°C | | | -25 25 | | | mV |
| | | | Full range | | | -75 75 | | | |
| $I_{Z,\text{min}}$ | Minimum cathode current | | 25°C | | | 65 89 | | | μA |
| | | | Full range | | | 95 | | | |
| α_{VZ} | Average temperature coefficient of reverse breakdown voltage | $I_Z = 10\ \text{mA}$ | 25°C | | | ± 30 | | | ppm/°C |
| | | $I_Z = 1\ \text{mA}$ | 25°C | | | ± 20 | | | |
| | | | Full range | | | ± 100 | | | |
| $\frac{\Delta V_Z}{\Delta I_Z}$ | Reverse breakdown voltage change with cathode current change | $I_{Z,\text{min}} < I_Z < 1\ \text{mA}$ | 25°C | | | 0.5 1 | | | mV |
| | | | Full range | | | 1.4 1.8 | | | |
| | | $1\ \text{mA} < I_Z < 15\ \text{mA}$ | 25°C | | | 3.5 8 | | | |
| | | | Full range | | | 12 12 | | | |
| Z_Z | Reverse dynamic impedance | $I_Z = 1\ \text{mA}$, $f = 120\ \text{Hz}$, $I_{\text{AC}} = 0.1 I_Z$ | 25°C | | | 0.5 1.1 | | | Ω |
| e_N | Wideband noise | $I_Z = 100\ \mu\text{A}$, $10\ \text{Hz} \leq f \leq 10\ \text{kHz}$ | 25°C | | | 80 | | | μV_{RMS} |
| | Long-term stability of reverse breakdown voltage | $t = 1000\ \text{h}$, $T_A = 25^\circ\text{C} \pm 0.1^\circ\text{C}$, $I_Z = 100\ \mu\text{A}$ | | | | 120 | | | ppm |
| V_{HYST} | Thermal hysteresis ⁽¹⁾ | $\Delta T_A = -40^\circ\text{C}$ to 125°C | | | | 0.08 | | | % |

(1) Thermal hysteresis is defined as $V_{Z,25^\circ\text{C}}$ (after cycling to -40°C) – $V_{Z,25^\circ\text{C}}$ (after cycling to 125°C).

LM4040 PRECISION MICROPOWER SHUNT VOLTAGE REFERENCE

SLOS456J – JANUARY 2005 – REVISED SEPTEMBER 2006

LM4040x82I Electrical Characteristics

at industrial temperature range, full-range $T_A = -40^\circ\text{C}$ to 85°C (unless otherwise noted)

| PARAMETER | TEST CONDITIONS | T_A | LM4040A82I | | | LM4040B82I | | | UNIT |
|---------------------------------|--|--|------------|-----|-----|---------------|-----|-----|----------------------------|
| | | | MIN | TYP | MAX | MIN | TYP | MAX | |
| V_Z | Reverse breakdown voltage | $I_Z = 150\ \mu\text{A}$ | 25°C | | | 8.192 | | | V |
| ΔV_Z | Reverse breakdown voltage tolerance | $I_Z = 150\ \mu\text{A}$ | 25°C | | | -8.2 8.2 | | | mV |
| | | | Full range | | | -61 61 | | | |
| $I_{Z,\text{min}}$ | Minimum cathode current | | 25°C | | | 67 106 | | | μA |
| | | | Full range | | | 110 | | | |
| α_{VZ} | Average temperature coefficient of reverse breakdown voltage | $I_Z = 10\ \text{mA}$ | 25°C | | | ± 40 | | | ppm/°C |
| | | $I_Z = 1\ \text{mA}$ | 25°C | | | ± 20 | | | |
| | | | Full range | | | ± 100 | | | |
| $\frac{\Delta V_Z}{\Delta I_Z}$ | Reverse breakdown voltage change with cathode current change | $I_{Z,\text{min}} < I_Z < 1\ \text{mA}$ | 25°C | | | 0.6 1.3 | | | mV |
| | | | Full range | | | 2.5 | | | |
| | | $1\ \text{mA} < I_Z < 15\ \text{mA}$ | 25°C | | | 7 10 | | | |
| | | | Full range | | | 18 | | | |
| Z_Z | Reverse dynamic impedance | $I_Z = 1\ \text{mA}$, $f = 120\ \text{Hz}$, $I_{AC} = 0.1 I_Z$ | 25°C | | | 0.6 1.5 | | | Ω |
| e_N | Wideband noise | $I_Z = 150\ \mu\text{A}$, $10\ \text{Hz} \leq f \leq 10\ \text{kHz}$ | 25°C | | | 130 | | | μV_{RMS} |
| | Long-term stability of reverse breakdown voltage | $t = 1000\ \text{h}$, $T_A = 25^\circ\text{C} \pm 0.1^\circ\text{C}$, $I_Z = 150\ \mu\text{A}$ | | | | 120 | | | ppm |
| V_{HYST} | Thermal hysteresis ⁽¹⁾ | $\Delta T_A = -40^\circ\text{C}$ to 125°C | | | | 0.08 | | | % |

(1) Thermal hysteresis is defined as $V_{Z,25^\circ\text{C}}$ (after cycling to -40°C) – $V_{Z,25^\circ\text{C}}$ (after cycling to 125°C).

LM4040x82I Electrical Characteristics

at industrial temperature range, full-range $T_A = -40^{\circ}\text{C}$ to 85°C (unless otherwise noted)

| PARAMETER | TEST CONDITIONS | T_A | LM4040C82I | | | LM4040D82I | | | UNIT |
|---------------------------------|--|--|------------|-----|-----|--------------|-----|-----|----------------------------|
| | | | MIN | TYP | MAX | MIN | TYP | MAX | |
| V_Z | Reverse breakdown voltage | $I_Z = 150\ \mu\text{A}$ | 25°C | | | 8.192 | | | V |
| ΔV_Z | Reverse breakdown voltage tolerance | $I_Z = 150\ \mu\text{A}$ | 25°C | | | -41 41 | | | mV |
| | | | Full range | | | -94 94 | | | |
| $I_{Z,\text{min}}$ | Minimum cathode current | | 25°C | | | 67 106 | | | μA |
| | | | Full range | | | 110 | | | |
| α_{VZ} | Average temperature coefficient of reverse breakdown voltage | $I_Z = 10\ \text{mA}$ | 25°C | | | ± 40 | | | ppm/°C |
| | | $I_Z = 1\ \text{mA}$ | 25°C | | | ± 20 | | | |
| | | | Full range | | | ± 100 | | | |
| $\frac{\Delta V_Z}{\Delta I_Z}$ | Reverse breakdown voltage change with cathode current change | $I_{Z,\text{min}} < I_Z < 1\ \text{mA}$ | 25°C | | | 0.6 1.3 | | | mV |
| | | | Full range | | | 2.5 3 | | | |
| | | $1\ \text{mA} < I_Z < 15\ \text{mA}$ | 25°C | | | 7 10 | | | |
| | | | Full range | | | 18 24 | | | |
| Z_Z | Reverse dynamic impedance | $I_Z = 1\ \text{mA}$, $f = 120\ \text{Hz}$, $I_{\text{AC}} = 0.1 I_Z$ | 25°C | | | 0.6 1.5 | | | Ω |
| e_N | Wideband noise | $I_Z = 150\ \mu\text{A}$, $10\ \text{Hz} \leq f \leq 10\ \text{kHz}$ | 25°C | | | 130 | | | μV_{RMS} |
| | Long-term stability of reverse breakdown voltage | $t = 1000\ \text{h}$, $T_A = 25^{\circ}\text{C} \pm 0.1^{\circ}\text{C}$, $I_Z = 150\ \mu\text{A}$ | | | | 120 | | | ppm |
| V_{HYST} | Thermal hysteresis ⁽¹⁾ | $\Delta T_A = -40^{\circ}\text{C}$ to 125°C | | | | 0.08 | | | % |

(1) Thermal hysteresis is defined as $V_{Z,25^{\circ}\text{C}}$ (after cycling to -40°C) – $V_{Z,25^{\circ}\text{C}}$ (after cycling to 125°C).

LM4040 PRECISION MICROPOWER SHUNT VOLTAGE REFERENCE

SLOS456J – JANUARY 2005 – REVISED SEPTEMBER 2006

LM4040x10I Electrical Characteristics

at industrial temperature range, full-range $T_A = -40^\circ\text{C}$ to 85°C (unless otherwise noted)

| PARAMETER | TEST CONDITIONS | T_A | LM4040A10I | | | LM4040B10I | | | UNIT |
|---------------------------------|--|--|------------|-----|-----|--------------|-----|-----|----------------------------|
| | | | MIN | TYP | MAX | MIN | TYP | MAX | |
| V_Z | Reverse breakdown voltage | $I_Z = 150\ \mu\text{A}$ | 25°C | | | 10 | | | V |
| ΔV_Z | Reverse breakdown voltage tolerance | $I_Z = 150\ \mu\text{A}$ | 25°C | | | -10 10 | | | mV |
| | | | Full range | | | -75 75 | | | |
| $I_{Z,\text{min}}$ | Minimum cathode current | | 25°C | | | 75 120 | | | μA |
| | | | Full range | | | 125 125 | | | |
| α_{VZ} | Average temperature coefficient of reverse breakdown voltage | $I_Z = 10\ \text{mA}$ | 25°C | | | ± 40 | | | ppm/°C |
| | | $I_Z = 1\ \text{mA}$ | 25°C | | | ± 20 | | | |
| | | | Full range | | | ± 100 | | | |
| $\frac{\Delta V_Z}{\Delta I_Z}$ | Reverse breakdown voltage change with cathode current change | $I_{Z,\text{min}} < I_Z < 1\ \text{mA}$ | 25°C | | | 0.8 1.5 | | | mV |
| | | | Full range | | | 3.5 3.5 | | | |
| | | $1\ \text{mA} < I_Z < 15\ \text{mA}$ | 25°C | | | 8 14 | | | |
| | | | Full range | | | 24 24 | | | |
| Z_Z | Reverse dynamic impedance | $I_Z = 1\ \text{mA}$, $f = 120\ \text{Hz}$, $I_{\text{AC}} = 0.1 I_Z$ | 25°C | | | 0.7 1.7 | | | Ω |
| e_N | Wideband noise | $I_Z = 150\ \mu\text{A}$, $10\ \text{Hz} \leq f \leq 10\ \text{kHz}$ | 25°C | | | 180 | | | μV_{RMS} |
| | Long-term stability of reverse breakdown voltage | $t = 1000\ \text{h}$, $T_A = 25^\circ\text{C} \pm 0.1^\circ\text{C}$, $I_Z = 150\ \mu\text{A}$ | | | | 120 | | | ppm |
| V_{HYST} | Thermal hysteresis ⁽¹⁾ | $\Delta T_A = -40^\circ\text{C}$ to 125°C | | | | 0.08 | | | % |

(1) Thermal hysteresis is defined as $V_{Z,25^\circ\text{C}}$ (after cycling to -40°C) – $V_{Z,25^\circ\text{C}}$ (after cycling to 125°C).

LM4040x10I Electrical Characteristics

at industrial temperature range, full-range $T_A = -40^{\circ}\text{C}$ to 85°C (unless otherwise noted)

| PARAMETER | TEST CONDITIONS | T_A | LM4040C10I | | | LM4040D10I | | | UNIT |
|---------------------------------|--|--|------------|-----|-----|--|-----|-----|----------------------------|
| | | | MIN | TYP | MAX | MIN | TYP | MAX | |
| V_Z | Reverse breakdown voltage | $I_Z = 150\ \mu\text{A}$ | 25°C | | | 10 | | | V |
| ΔV_Z | Reverse breakdown voltage tolerance | $I_Z = 150\ \mu\text{A}$ | 25°C | | | -50 50 | | | mV |
| | | | Full range | | | -115 115 | | | |
| $I_{Z,\text{min}}$ | Minimum cathode current | | 25°C | | | 75 120 | | | μA |
| | | | Full range | | | 125 135 | | | |
| α_{VZ} | Average temperature coefficient of reverse breakdown voltage | $I_Z = 10\ \text{mA}$ | 25°C | | | ± 40 | | | ppm/°C |
| | | $I_Z = 1\ \text{mA}$ | 25°C | | | ± 20 | | | |
| | | | Full range | | | ± 100 | | | |
| $\frac{\Delta V_Z}{\Delta I_Z}$ | Reverse breakdown voltage change with cathode current change | $I_{Z,\text{min}} < I_Z < 1\ \text{mA}$ | 25°C | | | 0.8 1.5 0.8 2 | | | mV |
| | | | Full range | | | 3.5 4 | | | |
| | | $1\ \text{mA} < I_Z < 15\ \text{mA}$ | 25°C | | | 8 14 8 18 | | | |
| | | | Full range | | | 24 29 | | | |
| Z_Z | Reverse dynamic impedance | $I_Z = 1\ \text{mA}$, $f = 120\ \text{Hz}$, $I_{\text{AC}} = 0.1 I_Z$ | 25°C | | | 0.7 1.7 0.7 2.3 | | | Ω |
| e_N | Wideband noise | $I_Z = 150\ \mu\text{A}$, $10\ \text{Hz} \leq f \leq 10\ \text{kHz}$ | 25°C | | | 180 | | | μV_{RMS} |
| | Long-term stability of reverse breakdown voltage | $t = 1000\ \text{h}$, $T_A = 25^{\circ}\text{C} \pm 0.1^{\circ}\text{C}$, $I_Z = 150\ \mu\text{A}$ | | | | 120 | | | ppm |
| V_{HYST} | Thermal hysteresis ⁽¹⁾ | $\Delta T_A = -40^{\circ}\text{C}$ to 125°C | | | | 0.08 | | | % |

(1) Thermal hysteresis is defined as $V_{Z,25^{\circ}\text{C}}$ (after cycling to -40°C) – $V_{Z,25^{\circ}\text{C}}$ (after cycling to 125°C).

TYPICAL CHARACTERISTICS

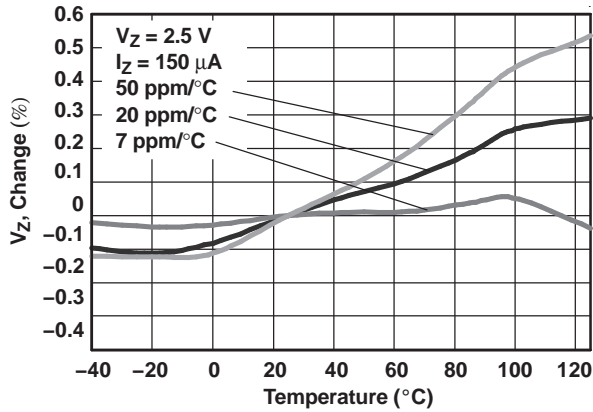

Figure 1. Temperature Drift for Different Average Temperature Coefficients

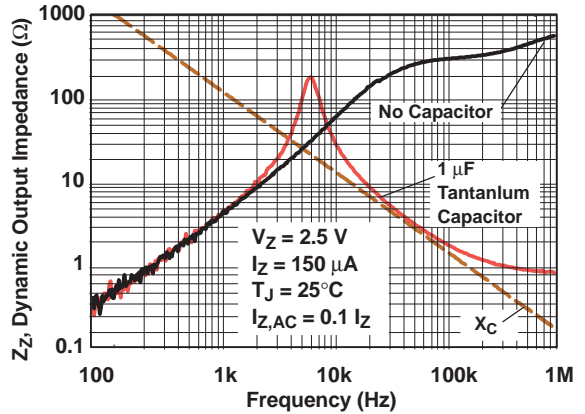

Figure 2. Output Impedance vs Frequency

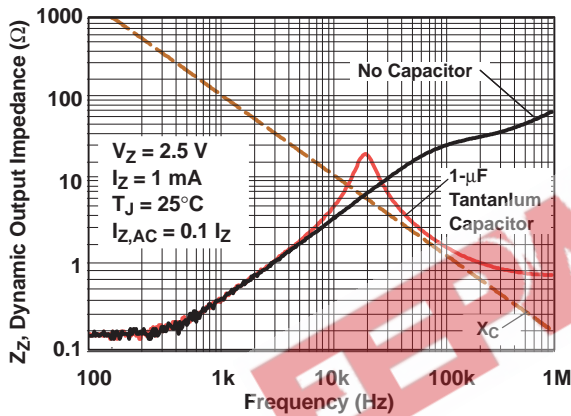

Figure 3. Output Impedance vs Frequency

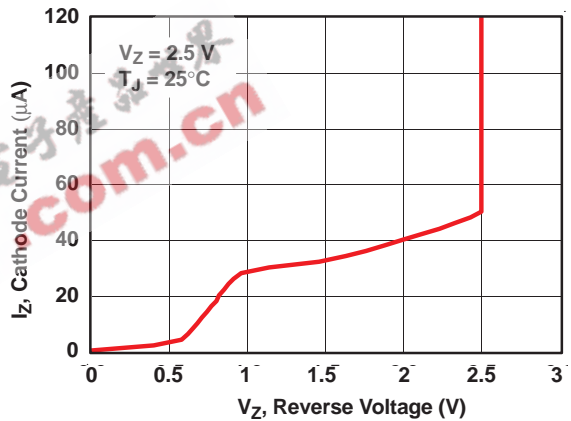

Figure 4. Temperature Drift for Different Average Temperature Coefficient

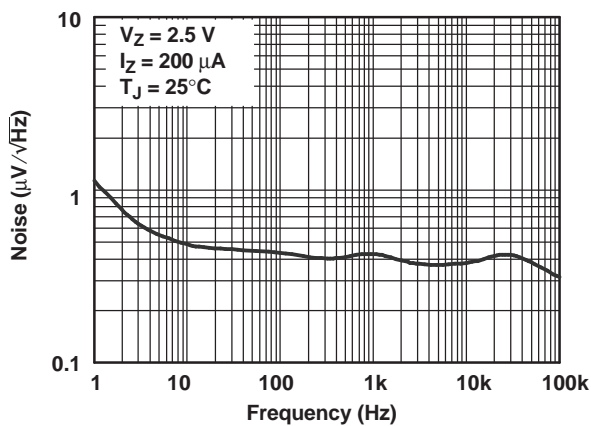

Figure 5. Noise Voltage vs Frequency

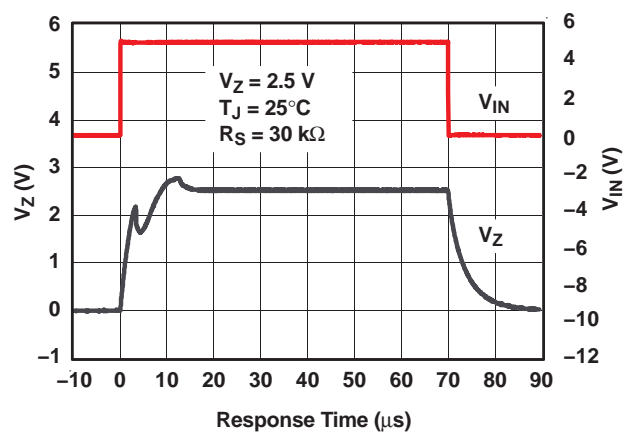

Figure 6. Start-Up Characteristics

APPLICATION INFORMATION

Start-Up Characteristics

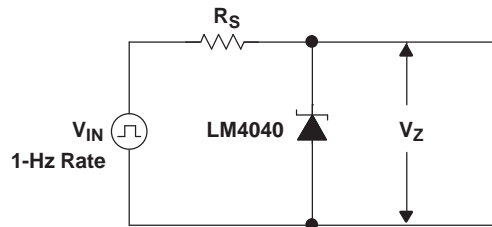

Figure 7. Test Circuit

Output Capacitor

The LM4040 does not require an output capacitor across cathode and anode for stability. However, if an output bypass capacitor is desired, the LM4040 is designed to be stable with all capacitive loads.

SOT-23 Connections

There is a parasitic Schottky diode connected between pins 2 and 3 of the SOT-23 packaged device. Thus, pin 3 of the SOT-23 package must be left floating or connected to pin 2.

Use With ADCs or DACs

The LM4040x-41 is designed to be a cost-effective voltage reference as required in 12-bit data-acquisition systems. For 12-bit systems operating from 5-V supplies such as the ADS7842 (see Figure 8), the LM4040x-41 (4.096 V) permits operation with an LSB of 1 mV.

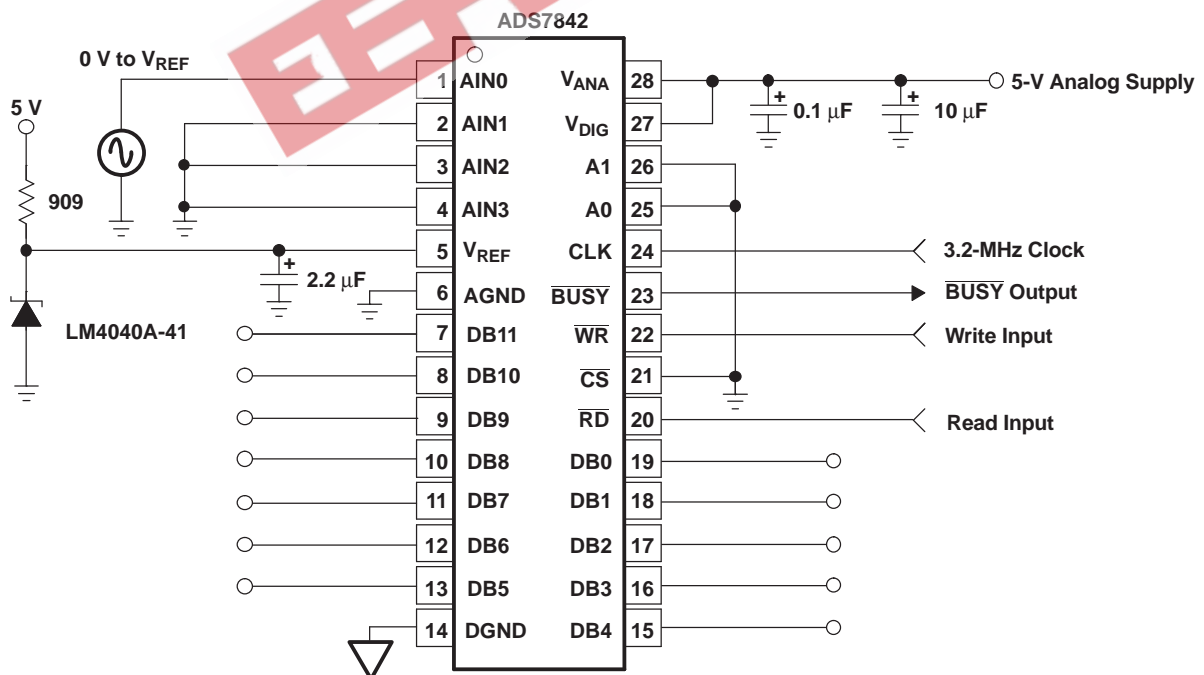

Figure 8. Data-Acquisition Circuit With LM4040x-41

APPLICATION INFORMATION (continued)

Cathode and Load Currents

In a typical shunt-regulator configuration (see Figure 9), an external resistor, R_S , is connected between the supply and the cathode of the LM4040. R_S must be set properly, as it sets the total current available to supply the load (I_L) and bias the LM4040 (I_Z). In all cases, I_Z must stay within a specified range for proper operation of the reference. Taking into consideration one extreme in the variation of the load and supply voltage (maximum I_L and minimum V_S), R_S must be small enough to supply the minimum I_Z required for operation of the regulator, as given by data-sheet parameters. At the other extreme, maximum V_S and minimum I_L , R_S must be large enough to limit I_Z to less than its maximum-rated value of 15 mA.

R_S is calculated according to Equation 1:

$$R_S = \frac{(V_S - V_Z)}{(I_L + I_Z)} \quad (1)$$

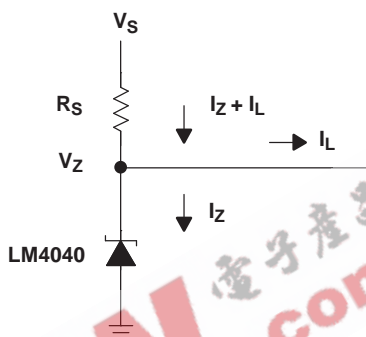

Figure 9. Shunt Regulator

PACKAGING INFORMATION

| Orderable Device | Status ⁽¹⁾ | Package Type | Package Drawing | Pins | Package Qty | Eco Plan ⁽²⁾ | Lead/Ball Finish | MSL Peak Temp ⁽³⁾ |
|------------------|-----------------------|--------------|-----------------|------|-------------|-------------------------|------------------|------------------------------|
| LM4040A10IDBZR | ACTIVE | SOT-23 | DBZ | 3 | 3000 | Green (RoHS & no Sb/Br) | CU NIPDAU | Level-1-260C-UNLIM |
| LM4040A10IDBZRG4 | ACTIVE | SOT-23 | DBZ | 3 | 3000 | Green (RoHS & no Sb/Br) | CU NIPDAU | Level-1-260C-UNLIM |
| LM4040A10IDBZT | ACTIVE | SOT-23 | DBZ | 3 | 250 | Green (RoHS & no Sb/Br) | CU NIPDAU | Level-1-260C-UNLIM |
| LM4040A10IDBZTG4 | ACTIVE | SOT-23 | DBZ | 3 | 250 | Green (RoHS & no Sb/Br) | CU NIPDAU | Level-1-260C-UNLIM |
| LM4040A10IDCKR | ACTIVE | SC70 | DCK | 5 | 3000 | Green (RoHS & no Sb/Br) | CU NIPDAU | Level-1-260C-UNLIM |
| LM4040A10IDCKRG4 | ACTIVE | SC70 | DCK | 5 | 3000 | Green (RoHS & no Sb/Br) | CU NIPDAU | Level-1-260C-UNLIM |
| LM4040A10ILP | PREVIEW | TO-92 | LP | 3 | 1000 | TBD | Call TI | Call TI |
| LM4040A10ILPR | PREVIEW | TO-92 | LP | 3 | 2000 | TBD | Call TI | Call TI |
| LM4040A20IDBZR | ACTIVE | SOT-23 | DBZ | 3 | 3000 | Green (RoHS & no Sb/Br) | CU NIPDAU | Level-1-260C-UNLIM |
| LM4040A20IDBZRG4 | ACTIVE | SOT-23 | DBZ | 3 | 3000 | Green (RoHS & no Sb/Br) | CU NIPDAU | Level-1-260C-UNLIM |
| LM4040A20IDBZT | ACTIVE | SOT-23 | DBZ | 3 | 250 | Green (RoHS & no Sb/Br) | CU NIPDAU | Level-1-260C-UNLIM |
| LM4040A20IDBZTG4 | ACTIVE | SOT-23 | DBZ | 3 | 250 | Green (RoHS & no Sb/Br) | CU NIPDAU | Level-1-260C-UNLIM |
| LM4040A20IDCKR | ACTIVE | SC70 | DCK | 5 | 3000 | Green (RoHS & no Sb/Br) | CU NIPDAU | Level-1-260C-UNLIM |
| LM4040A20IDCKRE4 | ACTIVE | SC70 | DCK | 5 | 3000 | Green (RoHS & no Sb/Br) | CU NIPDAU | Level-1-260C-UNLIM |
| LM4040A25IDBZR | ACTIVE | SOT-23 | DBZ | 3 | 3000 | Green (RoHS & no Sb/Br) | CU NIPDAU | Level-1-260C-UNLIM |
| LM4040A25IDBZRG4 | ACTIVE | SOT-23 | DBZ | 3 | 3000 | Green (RoHS & no Sb/Br) | CU NIPDAU | Level-1-260C-UNLIM |
| LM4040A25IDBZT | ACTIVE | SOT-23 | DBZ | 3 | 250 | Green (RoHS & no Sb/Br) | CU NIPDAU | Level-1-260C-UNLIM |
| LM4040A25IDBZTG4 | ACTIVE | SOT-23 | DBZ | 3 | 250 | Green (RoHS & no Sb/Br) | CU NIPDAU | Level-1-260C-UNLIM |
| LM4040A25IDCKR | ACTIVE | SC70 | DCK | 5 | 3000 | Green (RoHS & no Sb/Br) | CU NIPDAU | Level-1-260C-UNLIM |
| LM4040A25IDCKRE4 | ACTIVE | SC70 | DCK | 5 | 3000 | Green (RoHS & no Sb/Br) | CU NIPDAU | Level-1-260C-UNLIM |
| LM4040A25ILP | PREVIEW | TO-92 | LP | 3 | 1000 | TBD | Call TI | Call TI |
| LM4040A25ILPR | PREVIEW | TO-92 | LP | 3 | 2000 | TBD | Call TI | Call TI |
| LM4040A30IDBZR | ACTIVE | SOT-23 | DBZ | 3 | 3000 | Green (RoHS & no Sb/Br) | CU NIPDAU | Level-1-260C-UNLIM |
| LM4040A30IDBZRG4 | ACTIVE | SOT-23 | DBZ | 3 | 3000 | Green (RoHS & no Sb/Br) | CU NIPDAU | Level-1-260C-UNLIM |
| LM4040A30IDBZT | ACTIVE | SOT-23 | DBZ | 3 | 250 | Green (RoHS & no Sb/Br) | CU NIPDAU | Level-1-260C-UNLIM |
| LM4040A30IDBZTG4 | ACTIVE | SOT-23 | DBZ | 3 | 250 | Green (RoHS & no Sb/Br) | CU NIPDAU | Level-1-260C-UNLIM |
| LM4040A30IDCKR | ACTIVE | SC70 | DCK | 5 | 3000 | Green (RoHS & no Sb/Br) | CU NIPDAU | Level-1-260C-UNLIM |

| Orderable Device | Status ⁽¹⁾ | Package Type | Package Drawing | Pins | Package Qty | Eco Plan ⁽²⁾ | Lead/Ball Finish | MSL Peak Temp ⁽³⁾ |
|------------------|-----------------------|--------------|-----------------|------|-------------|-------------------------|------------------|------------------------------|
| | | | | | | no Sb/Br) | | |
| LM4040A30IDCKRE4 | ACTIVE | SC70 | DCK | 5 | 3000 | Green (RoHS & no Sb/Br) | CU NIPDAU | Level-1-260C-UNLIM |
| LM4040A30IDCKT | PREVIEW | SC70 | DCK | 5 | 250 | TBD | Call TI | Call TI |
| LM4040A30ILP | PREVIEW | TO-92 | LP | 3 | 1000 | TBD | Call TI | Call TI |
| LM4040A30ILPM | PREVIEW | TO-92 | LP | 3 | 2000 | TBD | Call TI | Call TI |
| LM4040A30ILPR | PREVIEW | TO-92 | LP | 3 | 2000 | TBD | Call TI | Call TI |
| LM4040A41IDBZR | ACTIVE | SOT-23 | DBZ | 3 | 3000 | Green (RoHS & no Sb/Br) | CU NIPDAU | Level-1-260C-UNLIM |
| LM4040A41IDBZRG4 | ACTIVE | SOT-23 | DBZ | 3 | 3000 | Green (RoHS & no Sb/Br) | CU NIPDAU | Level-1-260C-UNLIM |
| LM4040A41IDBZT | ACTIVE | SOT-23 | DBZ | 3 | 250 | Green (RoHS & no Sb/Br) | CU NIPDAU | Level-1-260C-UNLIM |
| LM4040A41IDBZTG4 | ACTIVE | SOT-23 | DBZ | 3 | 250 | Green (RoHS & no Sb/Br) | CU NIPDAU | Level-1-260C-UNLIM |
| LM4040A41IDCKR | ACTIVE | SC70 | DCK | 5 | 3000 | Green (RoHS & no Sb/Br) | CU NIPDAU | Level-1-260C-UNLIM |
| LM4040A41IDCKRE4 | ACTIVE | SC70 | DCK | 5 | 3000 | Green (RoHS & no Sb/Br) | CU NIPDAU | Level-1-260C-UNLIM |
| LM4040A41ILP | PREVIEW | TO-92 | LP | 3 | 1000 | TBD | Call TI | Call TI |
| LM4040A41ILPR | PREVIEW | TO-92 | LP | 3 | 2000 | TBD | Call TI | Call TI |
| LM4040A50IDBZR | ACTIVE | SOT-23 | DBZ | 3 | 3000 | Green (RoHS & no Sb/Br) | CU NIPDAU | Level-1-260C-UNLIM |
| LM4040A50IDBZRG4 | ACTIVE | SOT-23 | DBZ | 3 | 3000 | Green (RoHS & no Sb/Br) | CU NIPDAU | Level-1-260C-UNLIM |
| LM4040A50IDBZT | ACTIVE | SOT-23 | DBZ | 3 | 250 | Green (RoHS & no Sb/Br) | CU NIPDAU | Level-1-260C-UNLIM |
| LM4040A50IDBZTG4 | ACTIVE | SOT-23 | DBZ | 3 | 250 | Green (RoHS & no Sb/Br) | CU NIPDAU | Level-1-260C-UNLIM |
| LM4040A50IDCKR | ACTIVE | SC70 | DCK | 5 | 3000 | Green (RoHS & no Sb/Br) | CU NIPDAU | Level-1-260C-UNLIM |
| LM4040A50IDCKRE4 | ACTIVE | SC70 | DCK | 5 | 3000 | Green (RoHS & no Sb/Br) | CU NIPDAU | Level-1-260C-UNLIM |
| LM4040A50ILP | PREVIEW | TO-92 | LP | 3 | 1000 | TBD | Call TI | Call TI |
| LM4040A82IDBZR | ACTIVE | SOT-23 | DBZ | 3 | 3000 | Green (RoHS & no Sb/Br) | CU NIPDAU | Level-1-260C-UNLIM |
| LM4040A82IDBZRG4 | ACTIVE | SOT-23 | DBZ | 3 | 3000 | Green (RoHS & no Sb/Br) | CU NIPDAU | Level-1-260C-UNLIM |
| LM4040A82IDBZT | ACTIVE | SOT-23 | DBZ | 3 | 250 | Green (RoHS & no Sb/Br) | CU NIPDAU | Level-1-260C-UNLIM |
| LM4040A82IDBZTG4 | ACTIVE | SOT-23 | DBZ | 3 | 250 | Green (RoHS & no Sb/Br) | CU NIPDAU | Level-1-260C-UNLIM |
| LM4040A82IDCKR | ACTIVE | SC70 | DCK | 5 | 3000 | Green (RoHS & no Sb/Br) | CU NIPDAU | Level-1-260C-UNLIM |
| LM4040A82IDCKRG4 | ACTIVE | SC70 | DCK | 5 | 3000 | Green (RoHS & no Sb/Br) | CU NIPDAU | Level-1-260C-UNLIM |
| LM4040B10IDBZR | ACTIVE | SOT-23 | DBZ | 3 | 3000 | Green (RoHS & no Sb/Br) | CU NIPDAU | Level-1-260C-UNLIM |
| LM4040B10IDBZRG4 | ACTIVE | SOT-23 | DBZ | 3 | 3000 | Green (RoHS & no Sb/Br) | CU NIPDAU | Level-1-260C-UNLIM |

| Orderable Device | Status ⁽¹⁾ | Package Type | Package Drawing | Pins | Package Qty | Eco Plan ⁽²⁾ | Lead/Ball Finish | MSL Peak Temp ⁽³⁾ |
|------------------|-----------------------|--------------|-----------------|------|-------------|-------------------------|------------------|------------------------------|
| LM4040B10IDBZT | ACTIVE | SOT-23 | DBZ | 3 | 250 | Green (RoHS & no Sb/Br) | CU NIPDAU | Level-1-260C-UNLIM |
| LM4040B10IDBZTG4 | ACTIVE | SOT-23 | DBZ | 3 | 250 | Green (RoHS & no Sb/Br) | CU NIPDAU | Level-1-260C-UNLIM |
| LM4040B10IDCKR | ACTIVE | SC70 | DCK | 5 | 3000 | Green (RoHS & no Sb/Br) | CU NIPDAU | Level-1-260C-UNLIM |
| LM4040B10IDCKRG4 | ACTIVE | SC70 | DCK | 5 | 3000 | Green (RoHS & no Sb/Br) | CU NIPDAU | Level-1-260C-UNLIM |
| LM4040B10ILP | PREVIEW | TO-92 | LP | 3 | 1000 | TBD | Call TI | Call TI |
| LM4040B10ILPR | PREVIEW | TO-92 | LP | 3 | 2000 | TBD | Call TI | Call TI |
| LM4040B20IDBZR | ACTIVE | SOT-23 | DBZ | 3 | 3000 | Green (RoHS & no Sb/Br) | CU NIPDAU | Level-1-260C-UNLIM |
| LM4040B20IDBZRG4 | ACTIVE | SOT-23 | DBZ | 3 | 3000 | Green (RoHS & no Sb/Br) | CU NIPDAU | Level-1-260C-UNLIM |
| LM4040B20IDBZT | ACTIVE | SOT-23 | DBZ | 3 | 250 | Green (RoHS & no Sb/Br) | CU NIPDAU | Level-1-260C-UNLIM |
| LM4040B20IDBZTG4 | ACTIVE | SOT-23 | DBZ | 3 | 250 | Green (RoHS & no Sb/Br) | CU NIPDAU | Level-1-260C-UNLIM |
| LM4040B20IDCKR | ACTIVE | SC70 | DCK | 5 | 3000 | Green (RoHS & no Sb/Br) | CU NIPDAU | Level-1-260C-UNLIM |
| LM4040B20IDCKRE4 | ACTIVE | SC70 | DCK | 5 | 3000 | Green (RoHS & no Sb/Br) | CU NIPDAU | Level-1-260C-UNLIM |
| LM4040B25IDBZR | ACTIVE | SOT-23 | DBZ | 3 | 3000 | Green (RoHS & no Sb/Br) | CU NIPDAU | Level-1-260C-UNLIM |
| LM4040B25IDBZRG4 | ACTIVE | SOT-23 | DBZ | 3 | 3000 | Green (RoHS & no Sb/Br) | CU NIPDAU | Level-1-260C-UNLIM |
| LM4040B25IDBZT | ACTIVE | SOT-23 | DBZ | 3 | 250 | Green (RoHS & no Sb/Br) | CU NIPDAU | Level-1-260C-UNLIM |
| LM4040B25IDBZTG4 | ACTIVE | SOT-23 | DBZ | 3 | 250 | Green (RoHS & no Sb/Br) | CU NIPDAU | Level-1-260C-UNLIM |
| LM4040B25IDCKR | ACTIVE | SC70 | DCK | 5 | 3000 | Green (RoHS & no Sb/Br) | CU NIPDAU | Level-1-260C-UNLIM |
| LM4040B25IDCKRE4 | ACTIVE | SC70 | DCK | 5 | 3000 | Green (RoHS & no Sb/Br) | CU NIPDAU | Level-1-260C-UNLIM |
| LM4040B25ILP | PREVIEW | TO-92 | LP | 3 | 1000 | TBD | Call TI | Call TI |
| LM4040B25ILPR | PREVIEW | TO-92 | LP | 3 | 2000 | TBD | Call TI | Call TI |
| LM4040B30IDBZR | ACTIVE | SOT-23 | DBZ | 3 | 3000 | Green (RoHS & no Sb/Br) | CU NIPDAU | Level-1-260C-UNLIM |
| LM4040B30IDBZRG4 | ACTIVE | SOT-23 | DBZ | 3 | 3000 | Green (RoHS & no Sb/Br) | CU NIPDAU | Level-1-260C-UNLIM |
| LM4040B30IDBZT | ACTIVE | SOT-23 | DBZ | 3 | 250 | Green (RoHS & no Sb/Br) | CU NIPDAU | Level-1-260C-UNLIM |
| LM4040B30IDBZTG4 | ACTIVE | SOT-23 | DBZ | 3 | 250 | Green (RoHS & no Sb/Br) | CU NIPDAU | Level-1-260C-UNLIM |
| LM4040B30IDCKR | ACTIVE | SC70 | DCK | 5 | 3000 | Green (RoHS & no Sb/Br) | CU NIPDAU | Level-1-260C-UNLIM |
| LM4040B30IDCKRE4 | ACTIVE | SC70 | DCK | 5 | 3000 | Green (RoHS & no Sb/Br) | CU NIPDAU | Level-1-260C-UNLIM |
| LM4040B30IDCKT | PREVIEW | SC70 | DCK | 5 | 250 | TBD | Call TI | Call TI |
| LM4040B30ILP | PREVIEW | TO-92 | LP | 3 | 1000 | TBD | Call TI | Call TI |

| Orderable Device | Status ⁽¹⁾ | Package Type | Package Drawing | Pins | Package Qty | Eco Plan ⁽²⁾ | Lead/Ball Finish | MSL Peak Temp ⁽³⁾ |
|------------------|-----------------------|--------------|-----------------|------|-------------|-------------------------|------------------|------------------------------|
| LM4040B30ILPM | PREVIEW | TO-92 | LP | 3 | 2000 | TBD | Call TI | Call TI |
| LM4040B30ILPR | PREVIEW | TO-92 | LP | 3 | 2000 | TBD | Call TI | Call TI |
| LM4040B41IDBZR | ACTIVE | SOT-23 | DBZ | 3 | 3000 | Green (RoHS & no Sb/Br) | CU NIPDAU | Level-1-260C-UNLIM |
| LM4040B41IDBZRG4 | ACTIVE | SOT-23 | DBZ | 3 | 3000 | Green (RoHS & no Sb/Br) | CU NIPDAU | Level-1-260C-UNLIM |
| LM4040B41IDBZT | ACTIVE | SOT-23 | DBZ | 3 | 250 | Green (RoHS & no Sb/Br) | CU NIPDAU | Level-1-260C-UNLIM |
| LM4040B41IDBZTG4 | ACTIVE | SOT-23 | DBZ | 3 | 250 | Green (RoHS & no Sb/Br) | CU NIPDAU | Level-1-260C-UNLIM |
| LM4040B41IDCKR | ACTIVE | SC70 | DCK | 5 | 3000 | Green (RoHS & no Sb/Br) | CU NIPDAU | Level-1-260C-UNLIM |
| LM4040B41IDCKRE4 | ACTIVE | SC70 | DCK | 5 | 3000 | Green (RoHS & no Sb/Br) | CU NIPDAU | Level-1-260C-UNLIM |
| LM4040B41ILP | PREVIEW | TO-92 | LP | 3 | 1000 | TBD | Call TI | Call TI |
| LM4040B41ILPR | PREVIEW | TO-92 | LP | 3 | 2000 | TBD | Call TI | Call TI |
| LM4040B50IDBZR | ACTIVE | SOT-23 | DBZ | 3 | 3000 | Green (RoHS & no Sb/Br) | CU NIPDAU | Level-1-260C-UNLIM |
| LM4040B50IDBZRG4 | ACTIVE | SOT-23 | DBZ | 3 | 3000 | Green (RoHS & no Sb/Br) | CU NIPDAU | Level-1-260C-UNLIM |
| LM4040B50IDBZT | ACTIVE | SOT-23 | DBZ | 3 | 250 | Green (RoHS & no Sb/Br) | CU NIPDAU | Level-1-260C-UNLIM |
| LM4040B50IDBZTG4 | ACTIVE | SOT-23 | DBZ | 3 | 250 | Green (RoHS & no Sb/Br) | CU NIPDAU | Level-1-260C-UNLIM |
| LM4040B50IDCKR | ACTIVE | SC70 | DCK | 5 | 3000 | Green (RoHS & no Sb/Br) | CU NIPDAU | Level-1-260C-UNLIM |
| LM4040B50IDCKRE4 | ACTIVE | SC70 | DCK | 5 | 3000 | Green (RoHS & no Sb/Br) | CU NIPDAU | Level-1-260C-UNLIM |
| LM4040B50ILP | PREVIEW | TO-92 | LP | 3 | 1000 | TBD | Call TI | Call TI |
| LM4040B50ILPR | PREVIEW | TO-92 | LP | 3 | 2000 | TBD | Call TI | Call TI |
| LM4040B82IDBZR | ACTIVE | SOT-23 | DBZ | 3 | 3000 | Green (RoHS & no Sb/Br) | CU NIPDAU | Level-1-260C-UNLIM |
| LM4040B82IDBZRG4 | ACTIVE | SOT-23 | DBZ | 3 | 3000 | Green (RoHS & no Sb/Br) | CU NIPDAU | Level-1-260C-UNLIM |
| LM4040B82IDBZT | ACTIVE | SOT-23 | DBZ | 3 | 250 | Green (RoHS & no Sb/Br) | CU NIPDAU | Level-1-260C-UNLIM |
| LM4040B82IDBZTG4 | ACTIVE | SOT-23 | DBZ | 3 | 250 | Green (RoHS & no Sb/Br) | CU NIPDAU | Level-1-260C-UNLIM |
| LM4040B82IDCKR | ACTIVE | SC70 | DCK | 5 | 3000 | Green (RoHS & no Sb/Br) | CU NIPDAU | Level-1-260C-UNLIM |
| LM4040B82IDCKRG4 | ACTIVE | SC70 | DCK | 5 | 3000 | Green (RoHS & no Sb/Br) | CU NIPDAU | Level-1-260C-UNLIM |
| LM4040C10IDBZR | ACTIVE | SOT-23 | DBZ | 3 | 3000 | Green (RoHS & no Sb/Br) | CU NIPDAU | Level-1-260C-UNLIM |
| LM4040C10IDBZRG4 | ACTIVE | SOT-23 | DBZ | 3 | 3000 | Green (RoHS & no Sb/Br) | CU NIPDAU | Level-1-260C-UNLIM |
| LM4040C10IDBZT | ACTIVE | SOT-23 | DBZ | 3 | 250 | Green (RoHS & no Sb/Br) | CU NIPDAU | Level-1-260C-UNLIM |
| LM4040C10IDBZTG4 | ACTIVE | SOT-23 | DBZ | 3 | 250 | Green (RoHS & no Sb/Br) | CU NIPDAU | Level-1-260C-UNLIM |

| Orderable Device | Status ⁽¹⁾ | Package Type | Package Drawing | Pins | Package Qty | Eco Plan ⁽²⁾ | Lead/Ball Finish | MSL Peak Temp ⁽³⁾ |
|------------------|-----------------------|--------------|-----------------|------|-------------|-------------------------|------------------|------------------------------|
| LM4040C10IDCKR | ACTIVE | SC70 | DCK | 5 | 3000 | Green (RoHS & no Sb/Br) | CU NIPDAU | Level-1-260C-UNLIM |
| LM4040C10IDCKRG4 | ACTIVE | SC70 | DCK | 5 | 3000 | Green (RoHS & no Sb/Br) | CU NIPDAU | Level-1-260C-UNLIM |
| LM4040C10ILP | ACTIVE | TO-92 | LP | 3 | 1000 | Pb-Free (RoHS) | CU SN | N / A for Pkg Type |
| LM4040C10ILPR | ACTIVE | TO-92 | LP | 3 | 2000 | Pb-Free (RoHS) | CU SN | N / A for Pkg Type |
| LM4040C20IDBZR | ACTIVE | SOT-23 | DBZ | 3 | 3000 | Green (RoHS & no Sb/Br) | CU NIPDAU | Level-1-260C-UNLIM |
| LM4040C20IDBZRG4 | ACTIVE | SOT-23 | DBZ | 3 | 3000 | Green (RoHS & no Sb/Br) | CU NIPDAU | Level-1-260C-UNLIM |
| LM4040C20IDBZT | ACTIVE | SOT-23 | DBZ | 3 | 250 | Green (RoHS & no Sb/Br) | CU NIPDAU | Level-1-260C-UNLIM |
| LM4040C20IDBZTG4 | ACTIVE | SOT-23 | DBZ | 3 | 250 | Green (RoHS & no Sb/Br) | CU NIPDAU | Level-1-260C-UNLIM |
| LM4040C20IDCKR | ACTIVE | SC70 | DCK | 5 | 3000 | Green (RoHS & no Sb/Br) | CU NIPDAU | Level-1-260C-UNLIM |
| LM4040C20IDCKRE4 | ACTIVE | SC70 | DCK | 5 | 3000 | Green (RoHS & no Sb/Br) | CU NIPDAU | Level-1-260C-UNLIM |
| LM4040C20QDBZR | ACTIVE | SOT-23 | DBZ | 3 | 3000 | Green (RoHS & no Sb/Br) | CU NIPDAU | Level-1-260C-UNLIM |
| LM4040C20QDBZRG4 | ACTIVE | SOT-23 | DBZ | 3 | 3000 | Green (RoHS & no Sb/Br) | CU NIPDAU | Level-1-260C-UNLIM |
| LM4040C20QDBZT | ACTIVE | SOT-23 | DBZ | 3 | 250 | Green (RoHS & no Sb/Br) | CU NIPDAU | Level-1-260C-UNLIM |
| LM4040C20QDBZTG4 | ACTIVE | SOT-23 | DBZ | 3 | 250 | Green (RoHS & no Sb/Br) | CU NIPDAU | Level-1-260C-UNLIM |
| LM4040C25IDBZR | ACTIVE | SOT-23 | DBZ | 3 | 3000 | Green (RoHS & no Sb/Br) | CU NIPDAU | Level-1-260C-UNLIM |
| LM4040C25IDBZRG4 | ACTIVE | SOT-23 | DBZ | 3 | 3000 | Green (RoHS & no Sb/Br) | CU NIPDAU | Level-1-260C-UNLIM |
| LM4040C25IDBZT | ACTIVE | SOT-23 | DBZ | 3 | 250 | Green (RoHS & no Sb/Br) | CU NIPDAU | Level-1-260C-UNLIM |
| LM4040C25IDBZTG4 | ACTIVE | SOT-23 | DBZ | 3 | 250 | Green (RoHS & no Sb/Br) | CU NIPDAU | Level-1-260C-UNLIM |
| LM4040C25IDCKR | ACTIVE | SC70 | DCK | 5 | 3000 | Green (RoHS & no Sb/Br) | CU NIPDAU | Level-1-260C-UNLIM |
| LM4040C25IDCKRE4 | ACTIVE | SC70 | DCK | 5 | 3000 | Green (RoHS & no Sb/Br) | CU NIPDAU | Level-1-260C-UNLIM |
| LM4040C25IDCKT | ACTIVE | SC70 | DCK | 5 | 250 | Green (RoHS & no Sb/Br) | CU NIPDAU | Level-1-260C-UNLIM |
| LM4040C25IDCKTE4 | ACTIVE | SC70 | DCK | 5 | 250 | Green (RoHS & no Sb/Br) | CU NIPDAU | Level-1-260C-UNLIM |
| LM4040C25ILP | ACTIVE | TO-92 | LP | 3 | 1000 | TBD | CU SN | N / A for Pkg Type |
| LM4040C25ILPR | ACTIVE | TO-92 | LP | 3 | 2000 | TBD | CU SN | N / A for Pkg Type |
| LM4040C25QDBZR | ACTIVE | SOT-23 | DBZ | 3 | 3000 | Green (RoHS & no Sb/Br) | CU NIPDAU | Level-1-260C-UNLIM |
| LM4040C25QDBZRG4 | ACTIVE | SOT-23 | DBZ | 3 | 3000 | Green (RoHS & no Sb/Br) | CU NIPDAU | Level-1-260C-UNLIM |
| LM4040C25QDBZT | ACTIVE | SOT-23 | DBZ | 3 | 250 | Green (RoHS & no Sb/Br) | CU NIPDAU | Level-1-260C-UNLIM |

| Orderable Device | Status ⁽¹⁾ | Package Type | Package Drawing | Pins | Package Qty | Eco Plan ⁽²⁾ | Lead/Ball Finish | MSL Peak Temp ⁽³⁾ |
|------------------|-----------------------|--------------|-----------------|------|-------------|-------------------------|------------------|------------------------------|
| | | | | | | no Sb/Br) | | |
| LM4040C25QDBZTG4 | ACTIVE | SOT-23 | DBZ | 3 | 250 | Green (RoHS & no Sb/Br) | CU NIPDAU | Level-1-260C-UNLIM |
| LM4040C30IDBZR | ACTIVE | SOT-23 | DBZ | 3 | 3000 | Green (RoHS & no Sb/Br) | CU NIPDAU | Level-1-260C-UNLIM |
| LM4040C30IDBZRG4 | ACTIVE | SOT-23 | DBZ | 3 | 3000 | Green (RoHS & no Sb/Br) | CU NIPDAU | Level-1-260C-UNLIM |
| LM4040C30IDBZT | ACTIVE | SOT-23 | DBZ | 3 | 250 | Green (RoHS & no Sb/Br) | CU NIPDAU | Level-1-260C-UNLIM |
| LM4040C30IDBZTG4 | ACTIVE | SOT-23 | DBZ | 3 | 250 | Green (RoHS & no Sb/Br) | CU NIPDAU | Level-1-260C-UNLIM |
| LM4040C30IDCKR | ACTIVE | SC70 | DCK | 5 | 3000 | Green (RoHS & no Sb/Br) | CU NIPDAU | Level-1-260C-UNLIM |
| LM4040C30IDCKRE4 | ACTIVE | SC70 | DCK | 5 | 3000 | Green (RoHS & no Sb/Br) | CU NIPDAU | Level-1-260C-UNLIM |
| LM4040C30IDCKT | PREVIEW | SC70 | DCK | 5 | 250 | TBD | Call TI | Call TI |
| LM4040C30ILP | PREVIEW | TO-92 | LP | 3 | 1000 | TBD | Call TI | Call TI |
| LM4040C30ILPM | PREVIEW | TO-92 | LP | 3 | 2000 | TBD | Call TI | Call TI |
| LM4040C30ILPR | PREVIEW | TO-92 | LP | 3 | 2000 | TBD | Call TI | Call TI |
| LM4040C30QDBZR | ACTIVE | SOT-23 | DBZ | 3 | 3000 | Green (RoHS & no Sb/Br) | CU NIPDAU | Level-1-260C-UNLIM |
| LM4040C30QDBZRG4 | ACTIVE | SOT-23 | DBZ | 3 | 3000 | Green (RoHS & no Sb/Br) | CU NIPDAU | Level-1-260C-UNLIM |
| LM4040C30QDBZT | ACTIVE | SOT-23 | DBZ | 3 | 250 | Green (RoHS & no Sb/Br) | CU NIPDAU | Level-1-260C-UNLIM |
| LM4040C30QDBZTG4 | ACTIVE | SOT-23 | DBZ | 3 | 250 | Green (RoHS & no Sb/Br) | CU NIPDAU | Level-1-260C-UNLIM |
| LM4040C41IDBZR | ACTIVE | SOT-23 | DBZ | 3 | 3000 | Green (RoHS & no Sb/Br) | CU NIPDAU | Level-1-260C-UNLIM |
| LM4040C41IDBZRG4 | ACTIVE | SOT-23 | DBZ | 3 | 3000 | Green (RoHS & no Sb/Br) | CU NIPDAU | Level-1-260C-UNLIM |
| LM4040C41IDBZT | ACTIVE | SOT-23 | DBZ | 3 | 250 | Green (RoHS & no Sb/Br) | CU NIPDAU | Level-1-260C-UNLIM |
| LM4040C41IDBZTG4 | ACTIVE | SOT-23 | DBZ | 3 | 250 | Green (RoHS & no Sb/Br) | CU NIPDAU | Level-1-260C-UNLIM |
| LM4040C41IDCKR | ACTIVE | SC70 | DCK | 5 | 3000 | Green (RoHS & no Sb/Br) | CU NIPDAU | Level-1-260C-UNLIM |
| LM4040C41IDCKRE4 | ACTIVE | SC70 | DCK | 5 | 3000 | Green (RoHS & no Sb/Br) | CU NIPDAU | Level-1-260C-UNLIM |
| LM4040C41ILP | PREVIEW | TO-92 | LP | 3 | 1000 | TBD | Call TI | Call TI |
| LM4040C41ILPR | PREVIEW | TO-92 | LP | 3 | 2000 | TBD | Call TI | Call TI |
| LM4040C50IDBZR | ACTIVE | SOT-23 | DBZ | 3 | 3000 | Green (RoHS & no Sb/Br) | CU NIPDAU | Level-1-260C-UNLIM |
| LM4040C50IDBZRG4 | ACTIVE | SOT-23 | DBZ | 3 | 3000 | Green (RoHS & no Sb/Br) | CU NIPDAU | Level-1-260C-UNLIM |
| LM4040C50IDBZT | ACTIVE | SOT-23 | DBZ | 3 | 250 | Green (RoHS & no Sb/Br) | CU NIPDAU | Level-1-260C-UNLIM |
| LM4040C50IDBZTG4 | ACTIVE | SOT-23 | DBZ | 3 | 250 | Green (RoHS & no Sb/Br) | CU NIPDAU | Level-1-260C-UNLIM |
| LM4040C50IDCKR | ACTIVE | SC70 | DCK | 5 | 3000 | Green (RoHS & no Sb/Br) | CU NIPDAU | Level-1-260C-UNLIM |

| Orderable Device | Status ⁽¹⁾ | Package Type | Package Drawing | Pins | Package Qty | Eco Plan ⁽²⁾ | Lead/Ball Finish | MSL Peak Temp ⁽³⁾ |
|------------------|-----------------------|--------------|-----------------|------|-------------|-------------------------|------------------|------------------------------|
| | | | | | | no Sb/Br) | | |
| LM4040C50IDCKRE4 | ACTIVE | SC70 | DCK | 5 | 3000 | Green (RoHS & no Sb/Br) | CU NIPDAU | Level-1-260C-UNLIM |
| LM4040C50ILP | PREVIEW | TO-92 | LP | 3 | 1000 | TBD | Call TI | Call TI |
| LM4040C50ILPR | PREVIEW | TO-92 | LP | 3 | 2000 | TBD | Call TI | Call TI |
| LM4040C50QDBZR | ACTIVE | SOT-23 | DBZ | 3 | 3000 | Green (RoHS & no Sb/Br) | CU NIPDAU | Level-1-260C-UNLIM |
| LM4040C50QDBZRG4 | ACTIVE | SOT-23 | DBZ | 3 | 3000 | Green (RoHS & no Sb/Br) | CU NIPDAU | Level-1-260C-UNLIM |
| LM4040C50QDBZT | ACTIVE | SOT-23 | DBZ | 3 | 250 | Green (RoHS & no Sb/Br) | CU NIPDAU | Level-1-260C-UNLIM |
| LM4040C50QDBZTG4 | ACTIVE | SOT-23 | DBZ | 3 | 250 | Green (RoHS & no Sb/Br) | CU NIPDAU | Level-1-260C-UNLIM |
| LM4040C82IDBZR | ACTIVE | SOT-23 | DBZ | 3 | 3000 | Green (RoHS & no Sb/Br) | CU NIPDAU | Level-1-260C-UNLIM |
| LM4040C82IDBZRG4 | ACTIVE | SOT-23 | DBZ | 3 | 3000 | Green (RoHS & no Sb/Br) | CU NIPDAU | Level-1-260C-UNLIM |
| LM4040C82IDBZT | ACTIVE | SOT-23 | DBZ | 3 | 250 | Green (RoHS & no Sb/Br) | CU NIPDAU | Level-1-260C-UNLIM |
| LM4040C82IDBZTG4 | ACTIVE | SOT-23 | DBZ | 3 | 250 | Green (RoHS & no Sb/Br) | CU NIPDAU | Level-1-260C-UNLIM |
| LM4040C82IDCKR | ACTIVE | SC70 | DCK | 5 | 3000 | Green (RoHS & no Sb/Br) | CU NIPDAU | Level-1-260C-UNLIM |
| LM4040C82IDCKRG4 | ACTIVE | SC70 | DCK | 5 | 3000 | Green (RoHS & no Sb/Br) | CU NIPDAU | Level-1-260C-UNLIM |
| LM4040D20IDBZR | ACTIVE | SOT-23 | DBZ | 3 | 3000 | Green (RoHS & no Sb/Br) | CU NIPDAU | Level-1-260C-UNLIM |
| LM4040D20IDBZRG4 | ACTIVE | SOT-23 | DBZ | 3 | 3000 | Green (RoHS & no Sb/Br) | CU NIPDAU | Level-1-260C-UNLIM |
| LM4040D20IDBZT | ACTIVE | SOT-23 | DBZ | 3 | 250 | Green (RoHS & no Sb/Br) | CU NIPDAU | Level-1-260C-UNLIM |
| LM4040D20IDBZTG4 | ACTIVE | SOT-23 | DBZ | 3 | 250 | Green (RoHS & no Sb/Br) | CU NIPDAU | Level-1-260C-UNLIM |
| LM4040D20IDCKR | ACTIVE | SC70 | DCK | 5 | 3000 | Green (RoHS & no Sb/Br) | CU NIPDAU | Level-1-260C-UNLIM |
| LM4040D20IDCKRE4 | ACTIVE | SC70 | DCK | 5 | 3000 | Green (RoHS & no Sb/Br) | CU NIPDAU | Level-1-260C-UNLIM |
| LM4040D20QDBZR | ACTIVE | SOT-23 | DBZ | 3 | 3000 | Green (RoHS & no Sb/Br) | CU NIPDAU | Level-1-260C-UNLIM |
| LM4040D20QDBZRG4 | ACTIVE | SOT-23 | DBZ | 3 | 3000 | Green (RoHS & no Sb/Br) | CU NIPDAU | Level-1-260C-UNLIM |
| LM4040D20QDBZT | ACTIVE | SOT-23 | DBZ | 3 | 250 | Green (RoHS & no Sb/Br) | CU NIPDAU | Level-1-260C-UNLIM |
| LM4040D20QDBZTG4 | ACTIVE | SOT-23 | DBZ | 3 | 250 | Green (RoHS & no Sb/Br) | CU NIPDAU | Level-1-260C-UNLIM |
| LM4040D25IDBZR | ACTIVE | SOT-23 | DBZ | 3 | 3000 | Green (RoHS & no Sb/Br) | CU NIPDAU | Level-1-260C-UNLIM |
| LM4040D25IDBZRG4 | ACTIVE | SOT-23 | DBZ | 3 | 3000 | Green (RoHS & no Sb/Br) | CU NIPDAU | Level-1-260C-UNLIM |
| LM4040D25IDBZT | ACTIVE | SOT-23 | DBZ | 3 | 250 | Green (RoHS & no Sb/Br) | CU NIPDAU | Level-1-260C-UNLIM |

| Orderable Device | Status ⁽¹⁾ | Package Type | Package Drawing | Pins | Package Qty | Eco Plan ⁽²⁾ | Lead/Ball Finish | MSL Peak Temp ⁽³⁾ |
|------------------|-----------------------|--------------|-----------------|------|-------------|-------------------------|------------------|------------------------------|
| LM4040D25IDBZTG4 | ACTIVE | SOT-23 | DBZ | 3 | 250 | Green (RoHS & no Sb/Br) | CU NIPDAU | Level-1-260C-UNLIM |
| LM4040D25IDCKR | ACTIVE | SC70 | DCK | 5 | 3000 | Green (RoHS & no Sb/Br) | CU NIPDAU | Level-1-260C-UNLIM |
| LM4040D25IDCKRE4 | ACTIVE | SC70 | DCK | 5 | 3000 | Green (RoHS & no Sb/Br) | CU NIPDAU | Level-1-260C-UNLIM |
| LM4040D25IDCKT | ACTIVE | SC70 | DCK | 5 | 250 | Green (RoHS & no Sb/Br) | CU NIPDAU | Level-1-260C-UNLIM |
| LM4040D25IDCKTE4 | ACTIVE | SC70 | DCK | 5 | 250 | Green (RoHS & no Sb/Br) | CU NIPDAU | Level-1-260C-UNLIM |
| LM4040D25ILP | ACTIVE | TO-92 | LP | 3 | 1000 | TBD | CU SN | N / A for Pkg Type |
| LM4040D25ILPR | ACTIVE | TO-92 | LP | 3 | 2000 | TBD | CU SN | N / A for Pkg Type |
| LM4040D25QDBZR | ACTIVE | SOT-23 | DBZ | 3 | 3000 | Green (RoHS & no Sb/Br) | CU NIPDAU | Level-1-260C-UNLIM |
| LM4040D25QDBZRG4 | ACTIVE | SOT-23 | DBZ | 3 | 3000 | Green (RoHS & no Sb/Br) | CU NIPDAU | Level-1-260C-UNLIM |
| LM4040D25QDBZT | ACTIVE | SOT-23 | DBZ | 3 | 250 | Green (RoHS & no Sb/Br) | CU NIPDAU | Level-1-260C-UNLIM |
| LM4040D25QDBZTG4 | ACTIVE | SOT-23 | DBZ | 3 | 250 | Green (RoHS & no Sb/Br) | CU NIPDAU | Level-1-260C-UNLIM |
| LM4040D30IDBZR | ACTIVE | SOT-23 | DBZ | 3 | 3000 | Green (RoHS & no Sb/Br) | CU NIPDAU | Level-1-260C-UNLIM |
| LM4040D30IDBZRG4 | ACTIVE | SOT-23 | DBZ | 3 | 3000 | Green (RoHS & no Sb/Br) | CU NIPDAU | Level-1-260C-UNLIM |
| LM4040D30IDBZT | ACTIVE | SOT-23 | DBZ | 3 | 250 | Green (RoHS & no Sb/Br) | CU NIPDAU | Level-1-260C-UNLIM |
| LM4040D30IDBZTG4 | ACTIVE | SOT-23 | DBZ | 3 | 250 | Green (RoHS & no Sb/Br) | CU NIPDAU | Level-1-260C-UNLIM |
| LM4040D30IDCKR | ACTIVE | SC70 | DCK | 5 | 3000 | Green (RoHS & no Sb/Br) | CU NIPDAU | Level-1-260C-UNLIM |
| LM4040D30IDCKRE4 | ACTIVE | SC70 | DCK | 5 | 3000 | Green (RoHS & no Sb/Br) | CU NIPDAU | Level-1-260C-UNLIM |
| LM4040D30IDCKT | PREVIEW | SC70 | DCK | 5 | 250 | TBD | Call TI | Call TI |
| LM4040D30ILP | PREVIEW | TO-92 | LP | 3 | 1000 | TBD | Call TI | Call TI |
| LM4040D30ILPM | PREVIEW | TO-92 | LP | 3 | 2000 | TBD | Call TI | Call TI |
| LM4040D30ILPR | PREVIEW | TO-92 | LP | 3 | 2000 | TBD | Call TI | Call TI |
| LM4040D30QDBZR | ACTIVE | SOT-23 | DBZ | 3 | 3000 | Green (RoHS & no Sb/Br) | CU NIPDAU | Level-1-260C-UNLIM |
| LM4040D30QDBZRG4 | ACTIVE | SOT-23 | DBZ | 3 | 3000 | Green (RoHS & no Sb/Br) | CU NIPDAU | Level-1-260C-UNLIM |
| LM4040D30QDBZT | ACTIVE | SOT-23 | DBZ | 3 | 250 | Green (RoHS & no Sb/Br) | CU NIPDAU | Level-1-260C-UNLIM |
| LM4040D30QDBZTG4 | ACTIVE | SOT-23 | DBZ | 3 | 250 | Green (RoHS & no Sb/Br) | CU NIPDAU | Level-1-260C-UNLIM |
| LM4040D41IDBZR | ACTIVE | SOT-23 | DBZ | 3 | 3000 | Green (RoHS & no Sb/Br) | CU NIPDAU | Level-1-260C-UNLIM |
| LM4040D41IDBZRG4 | ACTIVE | SOT-23 | DBZ | 3 | 3000 | Green (RoHS & no Sb/Br) | CU NIPDAU | Level-1-260C-UNLIM |
| LM4040D41IDBZT | ACTIVE | SOT-23 | DBZ | 3 | 250 | Green (RoHS & no Sb/Br) | CU NIPDAU | Level-1-260C-UNLIM |

| Orderable Device | Status ⁽¹⁾ | Package Type | Package Drawing | Pins | Package Qty | Eco Plan ⁽²⁾ | Lead/Ball Finish | MSL Peak Temp ⁽³⁾ |
|------------------|-----------------------|--------------|-----------------|------|-------------|-------------------------|------------------|------------------------------|
| LM4040D41IDBZTG4 | ACTIVE | SOT-23 | DBZ | 3 | 250 | Green (RoHS & no Sb/Br) | CU NIPDAU | Level-1-260C-UNLIM |
| LM4040D41IDCKR | ACTIVE | SC70 | DCK | 5 | 3000 | Green (RoHS & no Sb/Br) | CU NIPDAU | Level-1-260C-UNLIM |
| LM4040D41IDCKRE4 | ACTIVE | SC70 | DCK | 5 | 3000 | Green (RoHS & no Sb/Br) | CU NIPDAU | Level-1-260C-UNLIM |
| LM4040D41ILP | PREVIEW | TO-92 | LP | 3 | 1000 | TBD | Call TI | Call TI |
| LM4040D41ILPR | PREVIEW | TO-92 | LP | 3 | 2000 | TBD | Call TI | Call TI |
| LM4040D50IDBZR | ACTIVE | SOT-23 | DBZ | 3 | 3000 | Green (RoHS & no Sb/Br) | CU NIPDAU | Level-1-260C-UNLIM |
| LM4040D50IDBZRG4 | ACTIVE | SOT-23 | DBZ | 3 | 3000 | Green (RoHS & no Sb/Br) | CU NIPDAU | Level-1-260C-UNLIM |
| LM4040D50IDBZT | ACTIVE | SOT-23 | DBZ | 3 | 250 | Green (RoHS & no Sb/Br) | CU NIPDAU | Level-1-260C-UNLIM |
| LM4040D50IDBZTG4 | ACTIVE | SOT-23 | DBZ | 3 | 250 | Green (RoHS & no Sb/Br) | CU NIPDAU | Level-1-260C-UNLIM |
| LM4040D50IDCKR | ACTIVE | SC70 | DCK | 5 | 3000 | Green (RoHS & no Sb/Br) | CU NIPDAU | Level-1-260C-UNLIM |
| LM4040D50IDCKRE4 | ACTIVE | SC70 | DCK | 5 | 3000 | Green (RoHS & no Sb/Br) | CU NIPDAU | Level-1-260C-UNLIM |
| LM4040D50ILP | PREVIEW | TO-92 | LP | 3 | 1000 | TBD | Call TI | Call TI |
| LM4040D50ILPR | PREVIEW | TO-92 | LP | 3 | 2000 | TBD | Call TI | Call TI |
| LM4040D50QDBZR | ACTIVE | SOT-23 | DBZ | 3 | 3000 | Green (RoHS & no Sb/Br) | CU NIPDAU | Level-1-260C-UNLIM |
| LM4040D50QDBZRG4 | ACTIVE | SOT-23 | DBZ | 3 | 3000 | Green (RoHS & no Sb/Br) | CU NIPDAU | Level-1-260C-UNLIM |
| LM4040D50QDBZT | ACTIVE | SOT-23 | DBZ | 3 | 250 | Green (RoHS & no Sb/Br) | CU NIPDAU | Level-1-260C-UNLIM |
| LM4040D50QDBZTG4 | ACTIVE | SOT-23 | DBZ | 3 | 250 | Green (RoHS & no Sb/Br) | CU NIPDAU | Level-1-260C-UNLIM |
| LM4040D82IDBZR | ACTIVE | SOT-23 | DBZ | 3 | 3000 | Green (RoHS & no Sb/Br) | CU NIPDAU | Level-1-260C-UNLIM |
| LM4040D82IDBZRG4 | ACTIVE | SOT-23 | DBZ | 3 | 3000 | Green (RoHS & no Sb/Br) | CU NIPDAU | Level-1-260C-UNLIM |
| LM4040D82IDBZT | ACTIVE | SOT-23 | DBZ | 3 | 250 | Green (RoHS & no Sb/Br) | CU NIPDAU | Level-1-260C-UNLIM |
| LM4040D82IDBZTG4 | ACTIVE | SOT-23 | DBZ | 3 | 250 | Green (RoHS & no Sb/Br) | CU NIPDAU | Level-1-260C-UNLIM |
| LM4040D82IDCKR | ACTIVE | SC70 | DCK | 5 | 3000 | Green (RoHS & no Sb/Br) | CU NIPDAU | Level-1-260C-UNLIM |
| LM4040D82IDCKRG4 | ACTIVE | SC70 | DCK | 5 | 3000 | Green (RoHS & no Sb/Br) | CU NIPDAU | Level-1-260C-UNLIM |

⁽¹⁾ The marketing status values are defined as follows:

ACTIVE: Product device recommended for new designs.

LIFEBUY: TI has announced that the device will be discontinued, and a lifetime-buy period is in effect.

NRND: Not recommended for new designs. Device is in production to support existing customers, but TI does not recommend using this part in a new design.

PREVIEW: Device has been announced but is not in production. Samples may or may not be available.

OBSOLETE: TI has discontinued the production of the device.

⁽²⁾ Eco Plan - The planned eco-friendly classification: Pb-Free (RoHS), Pb-Free (RoHS Exempt), or Green (RoHS & no Sb/Br) - please check

<http://www.ti.com/productcontent> for the latest availability information and additional product content details.

TBD: The Pb-Free/Green conversion plan has not been defined.

Pb-Free (RoHS): TI's terms "Lead-Free" or "Pb-Free" mean semiconductor products that are compatible with the current RoHS requirements for all 6 substances, including the requirement that lead not exceed 0.1% by weight in homogeneous materials. Where designed to be soldered at high temperatures, TI Pb-Free products are suitable for use in specified lead-free processes.

Pb-Free (RoHS Exempt): This component has a RoHS exemption for either 1) lead-based flip-chip solder bumps used between the die and package, or 2) lead-based die adhesive used between the die and leadframe. The component is otherwise considered Pb-Free (RoHS compatible) as defined above.

Green (RoHS & no Sb/Br): TI defines "Green" to mean Pb-Free (RoHS compatible), and free of Bromine (Br) and Antimony (Sb) based flame retardants (Br or Sb do not exceed 0.1% by weight in homogeneous material)

⁽³⁾ MSL, Peak Temp. -- The Moisture Sensitivity Level rating according to the JEDEC industry standard classifications, and peak solder temperature.

Important Information and Disclaimer:The information provided on this page represents TI's knowledge and belief as of the date that it is provided. TI bases its knowledge and belief on information provided by third parties, and makes no representation or warranty as to the accuracy of such information. Efforts are underway to better integrate information from third parties. TI has taken and continues to take reasonable steps to provide representative and accurate information but may not have conducted destructive testing or chemical analysis on incoming materials and chemicals. TI and TI suppliers consider certain information to be proprietary, and thus CAS numbers and other limited information may not be available for release.

In no event shall TI's liability arising out of such information exceed the total purchase price of the TI part(s) at issue in this document sold by TI to Customer on an annual basis.

EEPW 电子產品世界
.com.cn

MECHANICAL DATA

DCK (R-PDSO-G5)

PLASTIC SMALL-OUTLINE PACKAGE

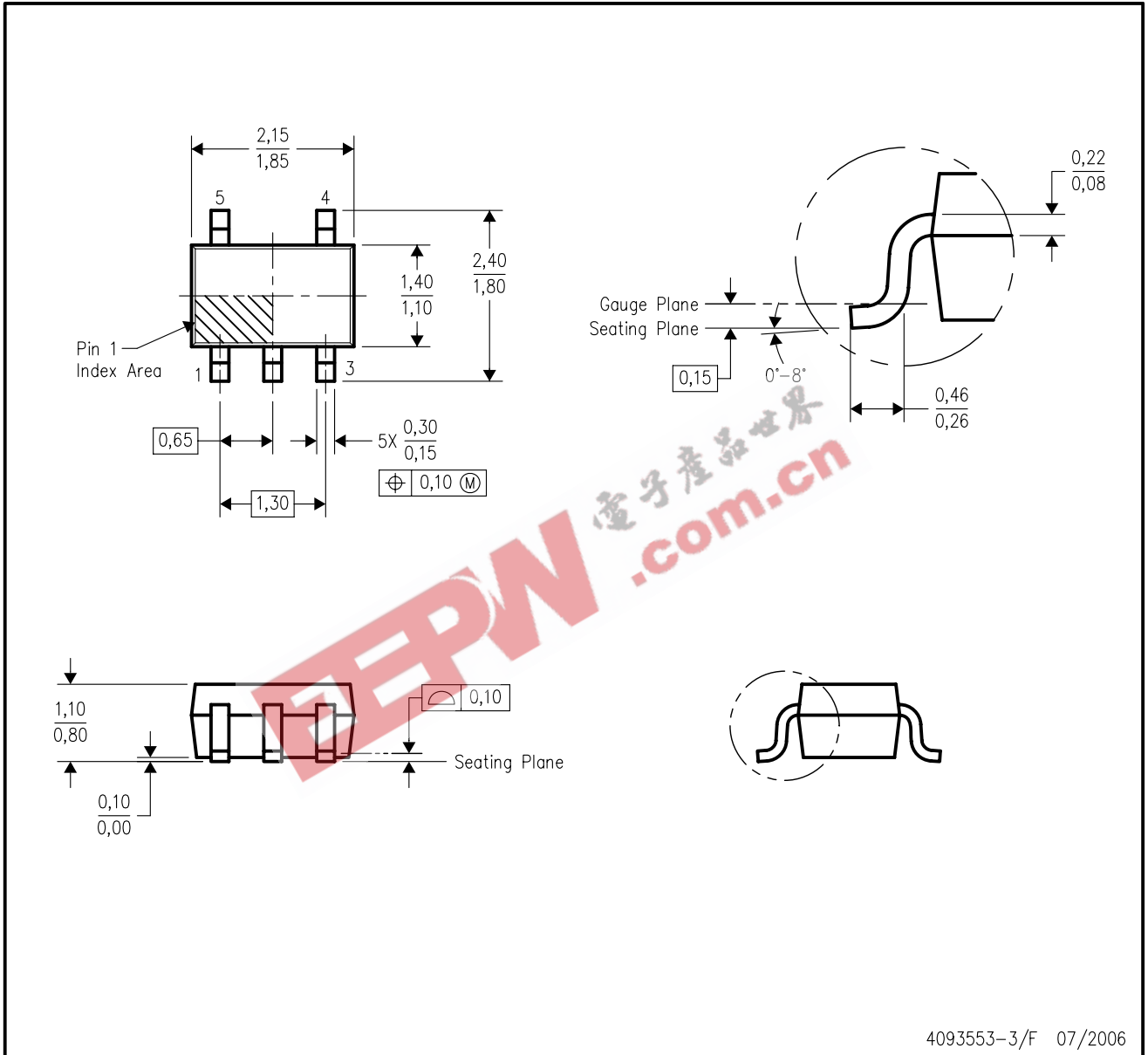

- NOTES:
- All linear dimensions are in millimeters.
 - This drawing is subject to change without notice.
 - Body dimensions do not include mold flash or protrusion. Mold flash and protrusion shall not exceed 0.15 per side.
 - Falls within JEDEC MO-203 variation AA.

DBZ (R-PDSO-G3)

PLASTIC SMALL-OUTLINE

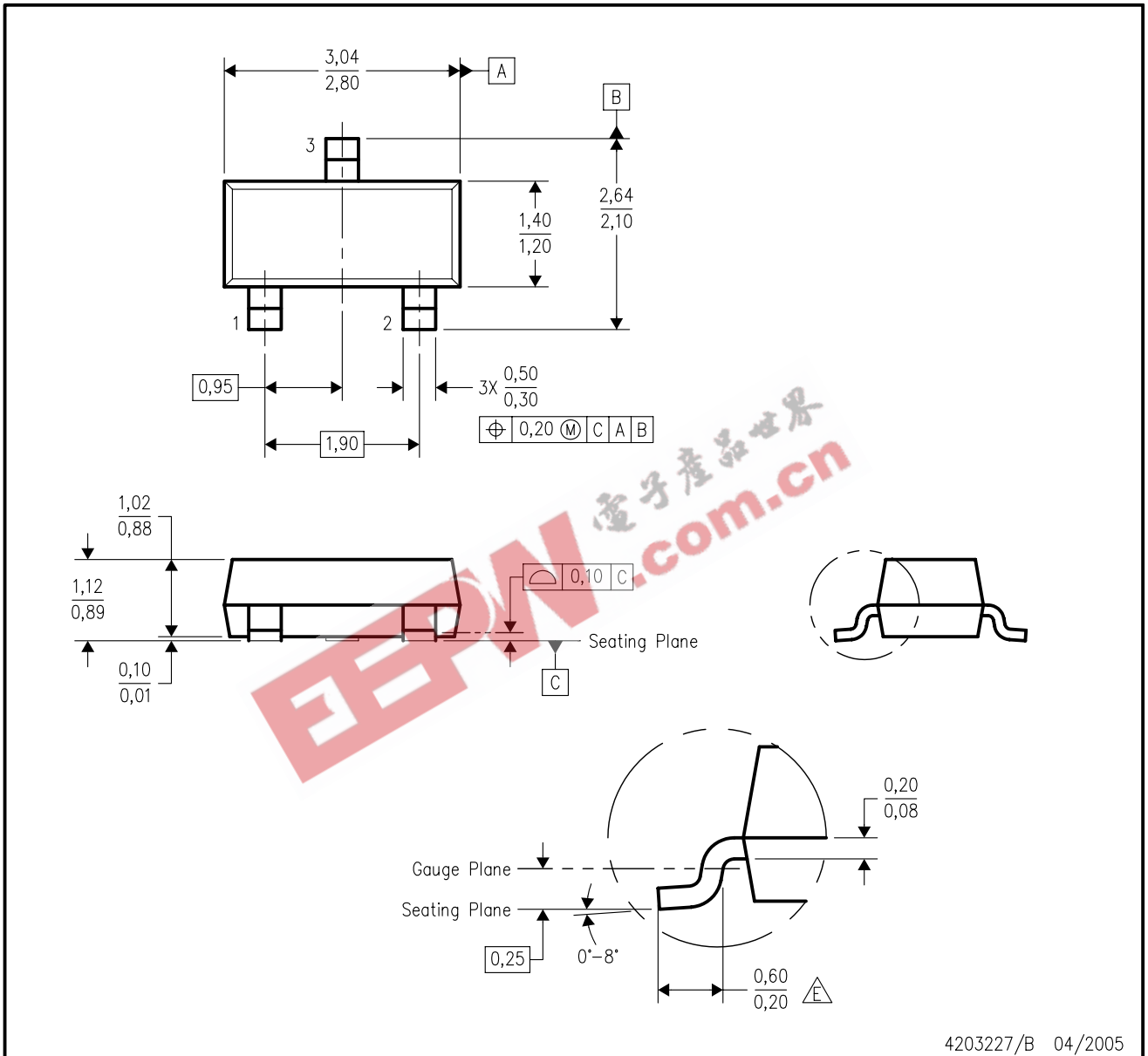

- NOTES:
- All linear dimensions are in millimeters. Dimensioning and tolerancing per ASME Y14.5M-1994.
 - This drawing is subject to change without notice.
 - Lead dimensions are inclusive of plating.
 - Body dimensions are exclusive of mold flash and protrusion. Mold flash and protrusion not to exceed 0.25 per side.
- $\triangle E$ Falls within JEDEC TO-236 variation AB, except minimum foot length.

MECHANICAL DATA

MSOT002A – OCTOBER 1994 – REVISED NOVEMBER 2001

LP (O-PBCY-W3)

PLASTIC CYLINDRICAL PACKAGE

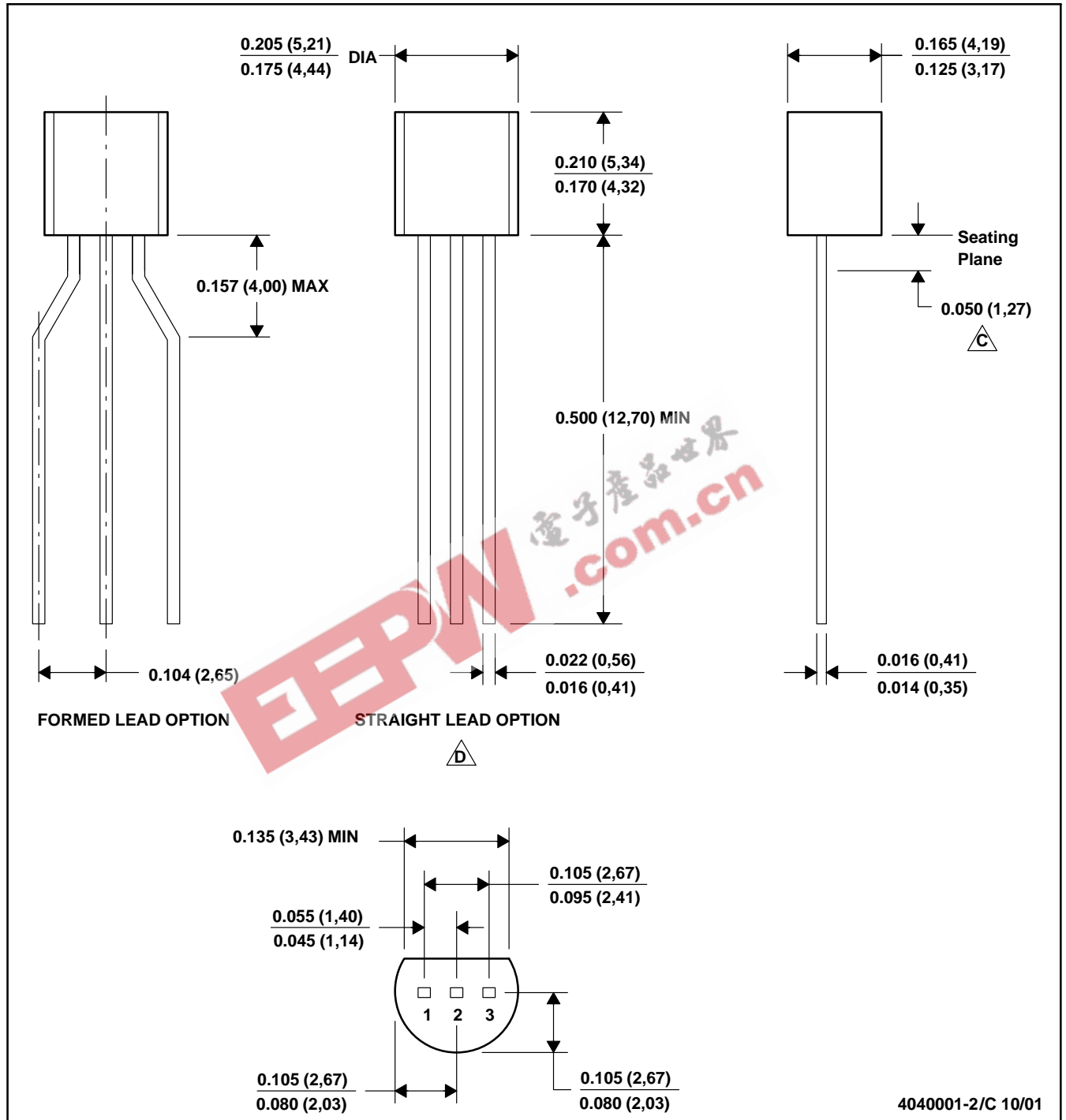

- NOTES:
- A. All linear dimensions are in inches (millimeters).
 - B. This drawing is subject to change without notice.
 - C** Lead dimensions are not controlled within this area
 - D** Falls within JEDEC TO -226 Variation AA (TO-226 replaces TO-92)
 - E. Shipping Method:
 - Straight lead option available in bulk pack only.
 - Formed lead option available in tape & reel or ammo pack.

MECHANICAL DATA

MSOT002A – OCTOBER 1994 – REVISED NOVEMBER 2001

LP (O-PBCY-W3)

PLASTIC CYLINDRICAL PACKAGE

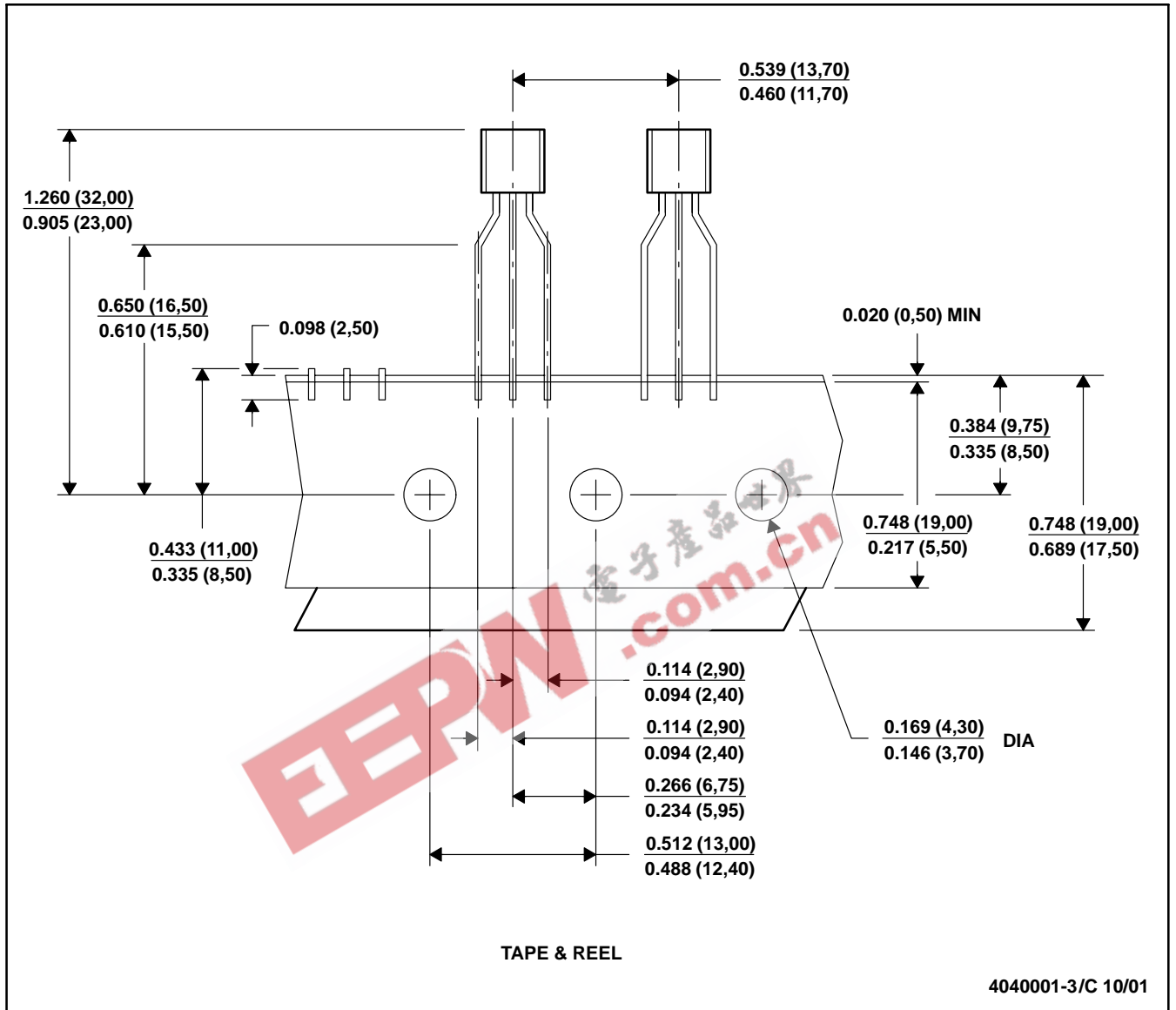

- NOTES:
- All linear dimensions are in inches (millimeters).
 - This drawing is subject to change without notice.
 - Tape and Reel information for the Format Lead Option package.

IMPORTANT NOTICE

Texas Instruments Incorporated and its subsidiaries (TI) reserve the right to make corrections, modifications, enhancements, improvements, and other changes to its products and services at any time and to discontinue any product or service without notice. Customers should obtain the latest relevant information before placing orders and should verify that such information is current and complete. All products are sold subject to TI's terms and conditions of sale supplied at the time of order acknowledgment.

TI warrants performance of its hardware products to the specifications applicable at the time of sale in accordance with TI's standard warranty. Testing and other quality control techniques are used to the extent TI deems necessary to support this warranty. Except where mandated by government requirements, testing of all parameters of each product is not necessarily performed.

TI assumes no liability for applications assistance or customer product design. Customers are responsible for their products and applications using TI components. To minimize the risks associated with customer products and applications, customers should provide adequate design and operating safeguards.

TI does not warrant or represent that any license, either express or implied, is granted under any TI patent right, copyright, mask work right, or other TI intellectual property right relating to any combination, machine, or process in which TI products or services are used. Information published by TI regarding third-party products or services does not constitute a license from TI to use such products or services or a warranty or endorsement thereof. Use of such information may require a license from a third party under the patents or other intellectual property of the third party, or a license from TI under the patents or other intellectual property of TI.

Reproduction of information in TI data books or data sheets is permissible only if reproduction is without alteration and is accompanied by all associated warranties, conditions, limitations, and notices. Reproduction of this information with alteration is an unfair and deceptive business practice. TI is not responsible or liable for such altered documentation.

Resale of TI products or services with statements different from or beyond the parameters stated by TI for that product or service voids all express and any implied warranties for the associated TI product or service and is an unfair and deceptive business practice. TI is not responsible or liable for any such statements.

Following are URLs where you can obtain information on other Texas Instruments products and application solutions:

| Products | | Applications | |
|--------------------|--|---------------------|--|
| Amplifiers | amplifier.ti.com | Audio | www.ti.com/audio |
| Data Converters | dataconverter.ti.com | Automotive | www.ti.com/automotive |
| DSP | dsp.ti.com | Broadband | www.ti.com/broadband |
| Interface | interface.ti.com | Digital Control | www.ti.com/digitalcontrol |
| Logic | logic.ti.com | Military | www.ti.com/military |
| Power Mgmt | power.ti.com | Optical Networking | www.ti.com/opticalnetwork |
| Microcontrollers | microcontroller.ti.com | Security | www.ti.com/security |
| Low Power Wireless | www.ti.com/lpw | Telephony | www.ti.com/telephony |
| | | Video & Imaging | www.ti.com/video |
| | | Wireless | www.ti.com/wireless |

Mailing Address: Texas Instruments
Post Office Box 655303 Dallas, Texas 75265