

LM4881 Boomer[®] Audio Power Amplifier Series

Dual 200 mW Headphone Amplifier with Shutdown Mode

General Description

The LM4881 is a dual audio power amplifier capable of delivering 200 mW of continuous average power into an 8Ω load with 0.1% (THD) from a 5V power supply.

Boomer audio power amplifiers were designed specifically to provide high quality output power with a minimal amount of external components using surface mount packaging. Since the LM4881 does not require bootstrap capacitors or snubber networks, it is optimally suited for low-power portable systems.

The LM4881 features an externally controlled, low power consumption shutdown mode which is virtually clickless and popless, as well as an internal thermal shutdown protection mechanism.

The unity-gain stable LM4881 can be configured by external gain-setting resistors.

Key Specifications

- THD at 1 kHz at 125 mW continuous average output power into 8Ω 0.1% (max)
- THD at 1 kHz at 75 mW continuous average output power into 32Ω 0.02% (typ)
- Output power at 10% THD+N at 1 kHz into 8Ω 300 mW (typ)
- Shutdown Current 0.7 μA (typ)

Features

- MSOP surface mount packaging
- Unity-gain stable
- External gain configuration capability
- Thermal shutdown protection circuitry
- No bootstrap capacitors, or snubber circuits are necessary

Applications

- Headphone Amplifier
- Personal Computers
- Microphone Preampifier

Typical Application

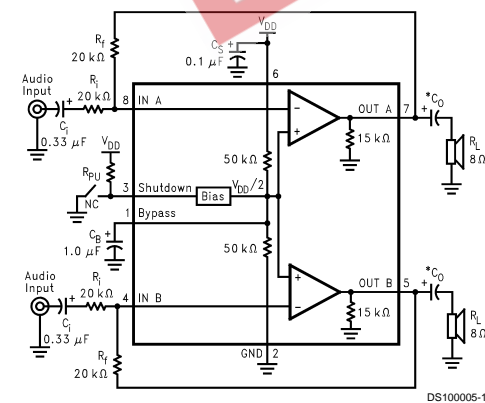

*Refer to the **Application Information** Section for information concerning proper selection of the input and output coupling capacitors.

FIGURE 1. Typical Audio Amplifier Application Circuit

Connection Diagrams

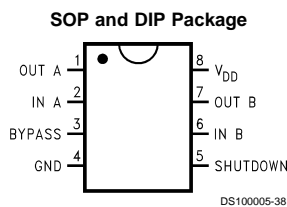
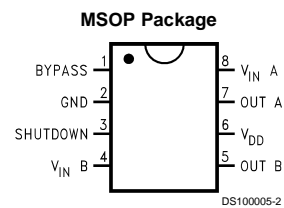

Top View

Order Number LM4881MM, LM4881M, or LM4881N
See NS Package Number MUA08A, M08A, or N08E

Absolute Maximum Ratings (Note 3)

If Military/Aerospace specified devices are required, please contact the National Semiconductor Sales Office/Distributors for availability and specifications.

| | |
|--------------------------------|--------------------------|
| Supply Voltage | 6.0V |
| Storage Temperature | -65°C to +150°C |
| Input Voltage | -0.3V to $V_{DD} + 0.3V$ |
| Power Dissipation (Note 4) | Internally limited |
| ESD Susceptibility (Note 5) | 3500V |
| ESD Susceptibility (Note 6) | 250V |
| Junction Temperature | 150°C |
| Soldering Information (Note 1) | |
| Small Outline Package | |
| Vapor Phase (60 seconds) | 215°C |
| Infrared (15 seconds) | 220°C |

Thermal Resistance

| | |
|----------------------|---------|
| θ_{JC} (MSOP) | 56°C/W |
| θ_{JA} (MSOP) | 210°C/W |
| θ_{JC} (SOP) | 35°C/W |
| θ_{JA} (SOP) | 170°C/W |
| θ_{JC} (DIP) | 37°C/W |
| θ_{JA} (DIP) | 107°C/W |

Operating Ratings

Temperature Range

$$T_{MIN} \leq T_A \leq T_{MAX} \quad -40^\circ\text{C} \leq T_A \leq 85^\circ\text{C}$$

Supply Voltage

$$2.7V \leq V_{DD} \leq 5.5V$$

Note 1: See AN-450 "Surface Mounting and their Effects on Product Reliability" for other methods of soldering surface mount devices.

Electrical Characteristics (Notes 2, 3)

The following specifications apply for $V_{DD} = 5V$ unless otherwise specified. Limits apply for $T_A = 25^\circ\text{C}$.

| Symbol | Parameter | Conditions | LM4881 | | Units (Limits) | |
|----------|-----------------------------------|--|------------------|----------------|---------------------|----|
| | | | Typ (Note 7) | Limit (Note 8) | | |
| V_{DD} | Power Supply Voltage | | 2.7 | 5.5 | V (min) | |
| | | | | | V (max) | |
| I_{DD} | Quiescent Current | $V_{IN} = 0V, I_O = 0A$ | 3.6 | 6.0 | mA (max) | |
| I_{SD} | Shutdown Current | $V_{PIN1} = V_{DD}$ | 0.7 | 5 | μA (max) | |
| V_{OS} | Offset Voltage | $V_{IN} = 0V$ | 5 | 50 | mV (max) | |
| P_O | Output Power | THD = 0.1% (max); $f = 1\text{ kHz}$; $R_L = 8\Omega$ | 200 | 125 | mW (min) | |
| | | | $R_L = 16\Omega$ | | 150 | mW |
| | | | $R_L = 32\Omega$ | | 85 | mW |
| | | THD + N = 10%; $f = 1\text{ kHz}$; $R_L = 8\Omega$ | 300 | mW | | |
| | | | $R_L = 16\Omega$ | 200 | mW | |
| | | | $R_L = 32\Omega$ | 110 | mW | |
| THD+N | Total Harmonic Distortion + Noise | $R_L = 16\Omega, P_O = 120\text{ mWrms}$; | 0.025 | | % | |
| | | $R_L = 32\Omega, P_O = 75\text{ mWrms}$; $f = 1\text{ kHz}$ | 0.02 | | % | |
| PSRR | | $C_B = 1.0\ \mu\text{F}, V_{RIPPLE} = 200\text{ mVrms}, f = 120\text{ Hz}$ | 50 | | dB | |

Electrical Characteristics (Notes 2, 3)

The following specifications apply for $V_{DD} = 3V$ unless otherwise specified. Limits apply for $T_A = 25^\circ C$.

| Symbol | Parameter | Conditions | LM4881 | | Units (Limits) | |
|----------|-----------------------------------|---|--------------|----------------|----------------|--|
| | | | Typ (Note 7) | Limit (Note 8) | | |
| I_{DD} | Quiescent Current | $V_{IN} = 0V, I_O = 0A$ | 1.1 | | mA | |
| I_{SD} | Shutdown Current | $V_{PIN1} = V_{DD}$ | 0.7 | | μA | |
| V_{OS} | Offset Voltage | $V_{IN} = 0V$ | 5 | | mV | |
| P_O | Output Power | THD = 1% (max); f = 1 kHz; | | | | |
| | | $R_L = 8\Omega$ | 70 | | mW | |
| | | $R_L = 16\Omega$ | 65 | | mW | |
| | | $R_L = 32\Omega$ | 30 | | mW | |
| | | THD + N = 10%; f = 1 kHz; | | | | |
| | | $R_L = 8\Omega$ | 95 | | mW | |
| | $R_L = 16\Omega$ | 65 | | mW | | |
| | $R_L = 32\Omega$ | 35 | | mW | | |
| THD+N | Total Harmonic Distortion + Noise | $R_L = 16\Omega, P_O = 60$ mWrms; | 0.2 | | % | |
| | | $R_L = 32\Omega, P_O = 25$ mWrms; f = 1 kHz | 0.03 | | % | |
| PSRR | Power Supply Rejection Ratio | $C_B = 1.0 \mu F, V_{RIPPLE} = 200$ mVrms, f = 100 Hz | 50 | | dB | |

Note 2: All voltages are measured with respect to the ground pin, unless otherwise specified.

Note 3: *Absolute Maximum Ratings* indicate limits beyond which damage to the device may occur. *Operating Ratings* indicate conditions for which the device is functional, but do not guarantee specific performance limits. *Electrical Characteristics* state DC and AC electrical specifications under particular test conditions which guarantee specific performance limits. This assumes that the device is within the Operating Ratings. Specifications are not guaranteed for parameters where no limit is given, however, the typical value is a good indication of device performance.

Note 4: The maximum power dissipation must be derated at elevated temperatures and is dictated by T_{JMAX} , θ_{JA} , and the ambient temperature T_A . The maximum allowable power dissipation is $P_{DMAX} = (T_{JMAX} - T_A) / \theta_{JA}$. For the LM4881, $T_{JMAX} = 150^\circ C$, and the typical junction-to-ambient thermal resistance, when board mounted, is $210^\circ C/W$ for the MSOP Package and $107^\circ C/W$ for package N08E.

Note 5: Human body model, 100 pF discharged through a 1.5 k Ω resistor.

Note 6: Machine Model, 220 pF–240 pF discharged through all pins.

Note 7: Typicals are measured at $25^\circ C$ and represent the parametric norm.

Note 8: Limits are guaranteed to National's AOQL (Average Outgoing Quality Level).

External Components Description (Figure 1)

| Components | Functional Description |
|------------|---|
| 1. R_i | Inverting input resistance which sets the closed-loop gain in conjunction with R_f . This resistor also forms a high pass filter with C_i at $f_c = 1 / (2\pi R_i C_i)$. |
| 2. C_i | Input coupling capacitor which blocks the DC voltage at the amplifier's input terminals. Also creates a highpass filter with R_i at $f_c = 1 / (2\pi R_i C_i)$. Refer to the section, Proper Selection of External Components , for an explanation of how to determine the value of C_i . |
| 3. R_f | Feedback resistance which sets closed-loop gain in conjunction with R_i . |
| 4. C_S | Supply bypass capacitor which provides power supply filtering. Refer to the Application Information section for proper placement and selection of the supply bypass capacitor. |
| 5. C_B | Bypass pin capacitor which provides half-supply filtering. Refer to the section, Proper Selection of External Components , for information concerning proper placement and selection of C_B . |
| 6. C_O | Output coupling capacitor which blocks the DC voltage at the amplifier's output. Forms a high pass filter with R_L at $f_c = 1/(2\pi R_L C_O)$ |

Typical Performance Characteristics

THD+N vs Frequency

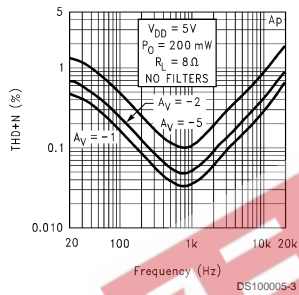

THD+N vs Frequency

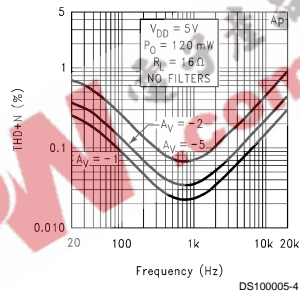

THD+N vs Frequency

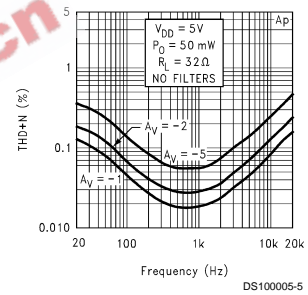

THD+N vs Frequency

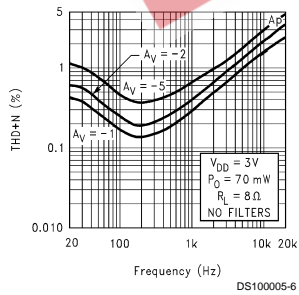

THD+N vs Frequency

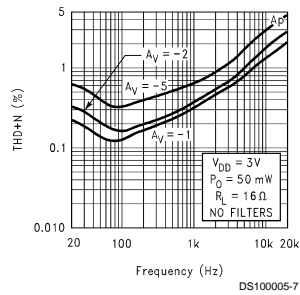

THD+N vs Frequency

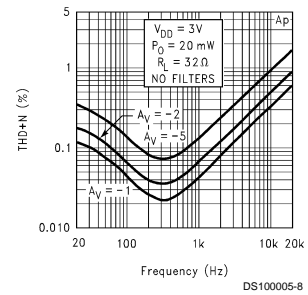

Typical Performance Characteristics (Continued)

THD+N vs Output Power

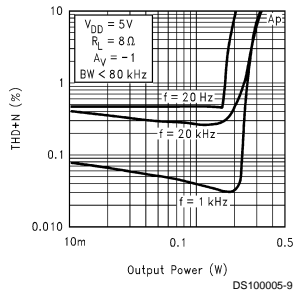

THD+N vs Output Power

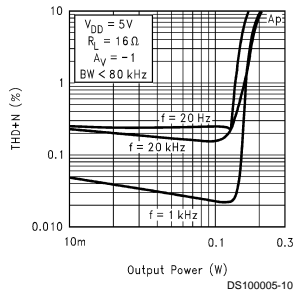

THD+N vs Output Power

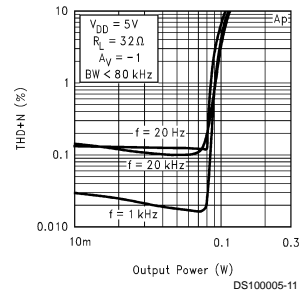

THD+N vs Output Power

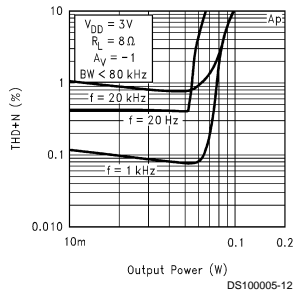

THD+N vs Output Power

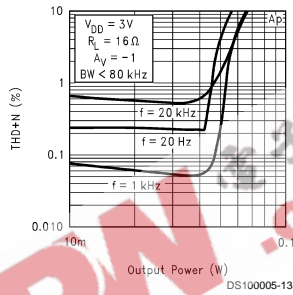

THD+N vs Output Power

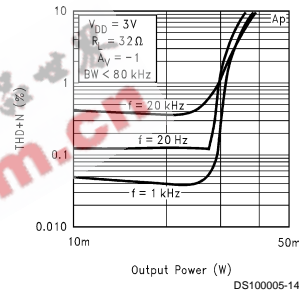

Output Power vs Supply Voltage

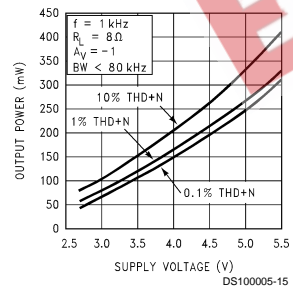

Output Power vs Supply Voltage

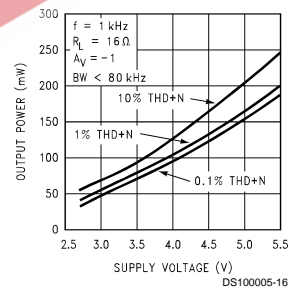

Output Power vs Supply Voltage

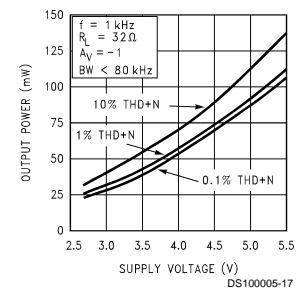

Typical Performance Characteristics (Continued)

Power Dissipation vs Output Power

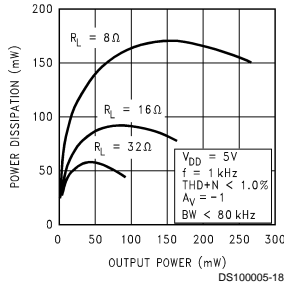

Output Power vs Load Resistance

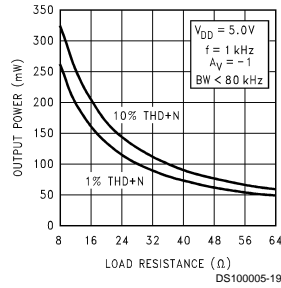

Output Power vs Load Resistance

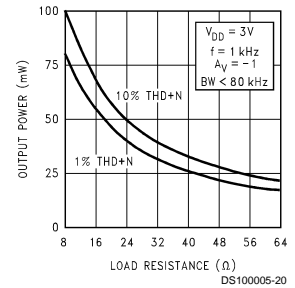

Power Dissipation vs Output Power

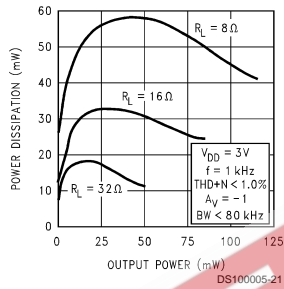

Clipping Voltage vs Supply Voltage

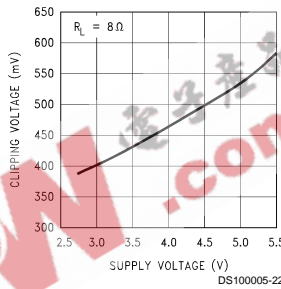

Clipping Voltage vs Supply Voltage

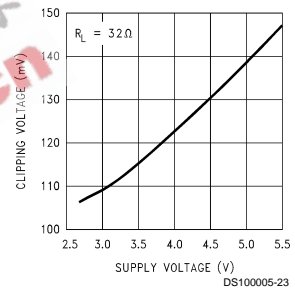

Channel Separation

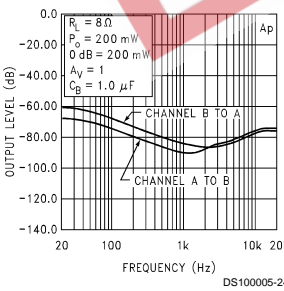

Output Attenuation in Shutdown Mode

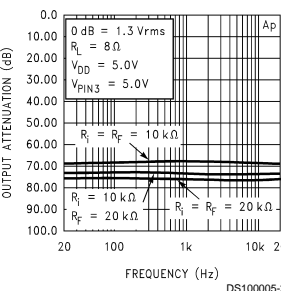

Supply Current vs Supply Voltage

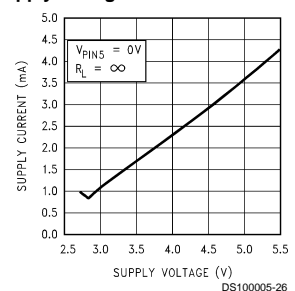

Typical Performance Characteristics (Continued)

Power Supply Rejection Ratio

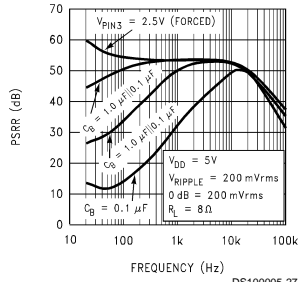

DS100005-27

Open Loop Frequency Response

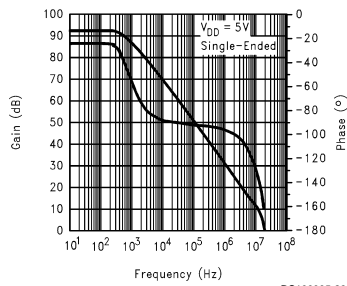

DS100005-28

Noise Floor

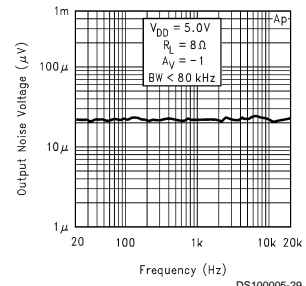

DS100005-29

Frequency Response vs Output Capacitor Size

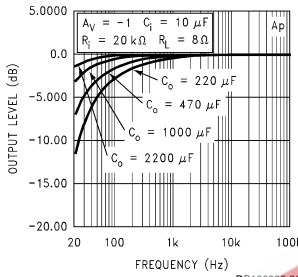

DS100005-30

Frequency Response vs Output Capacitor Size

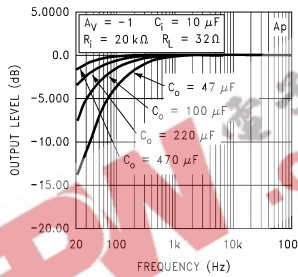

DS100005-31

Frequency Response vs Output Capacitor Size

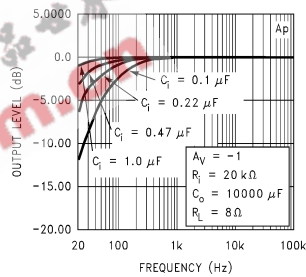

DS100005-32

Typical Application Frequency Response

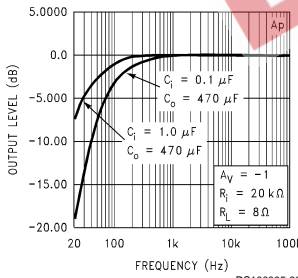

DS100005-33

Typical Application Frequency Response

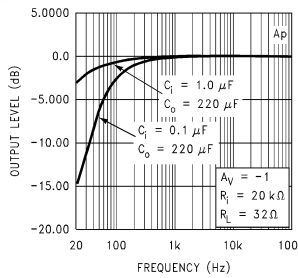

DS100005-34

Power Derating Curve

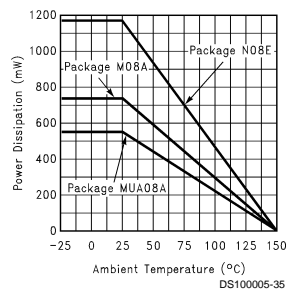

DS100005-35

Application Information

SHUTDOWN FUNCTION

In order to reduce power consumption while not in use, the LM4881 contains a shutdown pin to externally turn off the amplifier's bias circuitry. This shutdown feature turns the amplifier off when a logic high is placed on the shutdown pin. The trigger point between a logic low and logic high level is typically half supply. It is best to switch between ground and supply to provide maximum device performance. By switching the shutdown pin to the V_{DD} , the LM4881 supply current draw will be minimized in idle mode. While the device will be disabled with shutdown pin voltages less than V_{DD} , the idle current may be greater than the typical value of 0.7 μA . In either case, the shutdown pin should be tied to a definite voltage because leaving the pin floating may result in an unwanted shutdown condition. In many applications, a microcontroller or microprocessor output is used to control the shutdown circuitry which provides a quick, smooth transition into shutdown. Another solution is to use a single-pole, single-throw switch in conjunction with an external pull-up resistor. When the switch is closed, the shutdown pin is connected to ground and enables the amplifier. If the switch is open, then the external pull-up resistor will disable the LM4881. This scheme guarantees that the shutdown pin will not float which will prevent unwanted state changes.

POWER DISSIPATION

Power dissipation is a major concern when using any power amplifier and must be thoroughly understood to ensure a successful design. Equation 1 states the maximum power dissipation point for a single-ended amplifier operating at a given supply voltage and driving a specified output load.

$$P_{DMAX} = (V_{DD})^2 / (2\pi^2 R_L) \quad (1)$$

Since the LM4881 has two operational amplifiers in one package, the maximum internal power dissipation point is twice that of the number which results from Equation 1. Even with the large internal power dissipation, the LM4881 does not require heat sinking over a large range of ambient temperature. From Equation 1, assuming a 5V power supply and an 8 Ω load, the maximum power dissipation point is 158 mW per amplifier. Thus the maximum package dissipation point is 317 mW. The maximum power dissipation point obtained must not be greater than the power dissipation that results from Equation 2:

$$P_{DMAX} = (T_{JMAX} - T_A) / \theta_{JA} \quad (2)$$

For package MUA08A, $\theta_{JA} = 230^\circ\text{C}/\text{W}$, and for package M08A, $\theta_{JA} = 170^\circ\text{C}/\text{W}$, and for package N08E, $\theta_{JA} = 107^\circ\text{C}/\text{W}$. $T_{JMAX} = 150^\circ\text{C}$ for the LM4881. Depending on the ambient temperature, T_A , of the system surroundings, Equation 2 can be used to find the maximum internal power dissipation supported by the IC packaging. If the result of Equation 1 is greater than that of Equation 2, then either the supply voltage must be decreased, the load impedance increased or T_A reduced. For the typical application of a 5V power supply, with an 8 Ω load, the maximum ambient temperature possible without violating the maximum junction temperature is approximately 96 $^\circ\text{C}$ provided that device operation is around the maximum power dissipation point. Power dissipation is a function of output power and thus, if typical operation is not around the maximum power dissipation point, the ambient temperature may be increased accordingly. Refer to the **Typical Performance Characteristics** curves for power dissipation information for lower output powers.

POWER SUPPLY BYPASSING

As with any power amplifier, proper supply bypassing is critical for low noise performance and high power supply rejection. The capacitor location on both the bypass and power supply pins should be as close to the device as possible. As displayed in the **Typical Performance Characteristics** section, the effect of a larger half supply bypass capacitor is improved low frequency PSRR due to increased half-supply stability. Typical applications employ a 5V regulator with 10 μF and a 0.1 μF bypass capacitors which aid in supply stability, but do not eliminate the need for bypassing the supply nodes of the LM4881. The selection of bypass capacitors, especially C_B , is thus dependent upon desired low frequency PSRR, click and pop performance as explained in the section, **Proper Selection of External Components** section, system cost, and size constraints.

PROPER SELECTION OF EXTERNAL COMPONENTS

Selection of external components when using integrated power amplifiers is critical to optimize device and system performance. While the LM4881 is tolerant of external component combinations, consideration to component values must be used to maximize overall system quality.

The LM4881 is unity gain stable and this gives a designer maximum system flexibility. The LM4881 should be used in low gain configurations to minimize THD+N values, and maximum the signal-to-noise ratio. Low gain configurations require large input signals to obtain a given output power. Input signals equal to or greater than 1 Vrms are available from sources such as audio codecs. Please refer to the section, **Audio Power Amplifier Design**, for a more complete explanation of proper gain selection.

Besides gain, one of the major considerations is the closed loop bandwidth of the amplifier. To a large extent, the bandwidth is dictated by the choice of external components shown in *Figure 1*. Both the input coupling capacitor, C_i , and the output coupling capacitor, C_o , form first order high pass filters which limit low frequency response. These values should be chosen based on needed frequency response for a few distinct reasons.

Selection of Input and Output Capacitor Size

Large input and output capacitors are both expensive and space hungry for portable designs. Clearly a certain sized capacitor is needed to couple in low frequencies without severe attenuation. But in many cases the speakers used in portable systems, whether internal or external, have little ability to reproduce signals below 150 Hz. Thus using large input and output capacitors may not increase system performance.

In addition to system cost and size, click and pop performance is effected by the size of the input coupling capacitor, C_i . A larger input coupling capacitor requires more charge to reach its quiescent DC voltage (nominally 1/2 V_{DD}). This charge comes from the output via the feedback and is apt to create pops upon device enable. Thus, by minimizing the capacitor size based on necessary low frequency response, turn on pops can be minimized.

Besides minimizing the input and output capacitor sizes, careful consideration should be paid to the bypass capacitor value. Bypass capacitor C_B is the most critical component to minimize turn on pops since it determines how fast the LM4881 turns on. The slower the LM4881's outputs ramp to their quiescent DC voltage (nominally 1/2 V_{DD}), the smaller the turn on pop. Thus choosing C_B equal to 1.0 μF along with a small value of C_i (in the range of 0.1 μF to 0.39 μF), the

Application Information (Continued)

shutdown function should be virtually clickless and popless. While the device will function properly, (no oscillations or motorboating), with C_B equal to 0.1 μF , the device will be much more susceptible to turn on clicks and pops. Thus, a value of C_B equal to 0.1 μF or larger is recommended in all but the most cost sensitive designs.

AUDIO POWER AMPLIFIER DESIGN

Design a Dual 200mW/8 Ω Audio Amplifier

Given:

| | |
|-----------------|-----------------------------|
| Power Output | 200 mWrms |
| Load Impedance | 8 Ω |
| Input Level | 1 Vrms (max) |
| Input Impedance | 20 k Ω |
| Bandwidth | 100 Hz–20 kHz \pm 0.50 dB |

A designer must first determine the needed supply rail to obtain the specified output power. Calculating the required supply rail involves knowing two parameters, V_{OPEAK} and also the dropout voltage. The latter is typically 530 mV and can be found from the graphs in the **Typical Performance Characteristics**. V_{OPEAK} can be determined from Equation 3.

$$V_{\text{opeak}} = \sqrt{(2R_L P_O)} \quad (3)$$

For 200 mW of output power into an 8 Ω load, the required V_{OPEAK} is 1.79 volts. A minimum supply rail of 2.32V results from adding V_{OPEAK} and V_{OD} . Since 5V is a standard supply voltage in most applications, it is chosen for the supply rail. Extra supply voltage creates headroom that allows the LM4881 to reproduce peaks in excess of 200 mW without clipping the signal. At this time, the designer must make sure that the power supply choice along with the output impedance does not violate the conditions explained in the **Power Dissipation** section. Remember that the maximum power

dissipation point from Equation 1 must be multiplied by two since there are two independent amplifiers inside the package.

Once the power dissipation equations have been addressed, the required gain can be determined from Equation 4.

$$A_V \geq \sqrt{(P_O R_L)} / (V_{IN}) = V_{\text{orms}} / V_{\text{inrms}} \quad (4)$$

$$A_V = R_f / R_i \quad (5)$$

From Equation 4, the minimum gain is: $A_V = 1.26$

Since the desired input impedance was 20 k Ω , and with a gain of 1.26, a value of 27 k Ω is designated for R_f , assuming 5% tolerance resistors. This combination results in a nominal gain of 1.35. The final design step is to address the bandwidth requirements which must be stated as a pair of -3 dB frequency points. Five times away from a -3 dB point is 0.17 dB down from passband response assuming a single pole roll-off. As stated in the **External Components** section, both R_i in conjunction with C_{i1} and C_o with R_L , create first order highpass filters. Thus to obtain the desired frequency low response of 100 Hz within ± 0.5 dB, both poles must be taken into consideration. The combination of two single order filters at the same frequency forms a second order response. This results in a signal which is down 0.34 dB at five times away from the single order filter -3 dB point. Thus, a frequency of 20 Hz is used in the following equations to ensure that the response is better than 0.5 dB down at 100 Hz.

$$C_{i1} \geq 1 / (2\pi * 20 \text{ k}\Omega * 20 \text{ Hz}) = 0.397 \mu\text{F}; \text{ use } 0.39 \mu\text{F}.$$

$$C_o \geq 1 / (2\pi * 8\Omega * 20 \text{ Hz}) = 995 \mu\text{F}; \text{ use } 1000 \mu\text{F}.$$

The high frequency pole is determined by the product of the desired high frequency pole, f_H , and the closed-loop gain, A_V . With a closed-loop gain of 1.35 and $f_H = 100$ kHz, the resulting GBWP = 135 kHz which is much smaller than the LM4881 GBWP of 18 MHz. This figure displays that if a designer has a need to design an amplifier with a higher gain, the LM4881 can still be used without running into bandwidth limitations.

Physical Dimensions inches (millimeters) unless otherwise noted

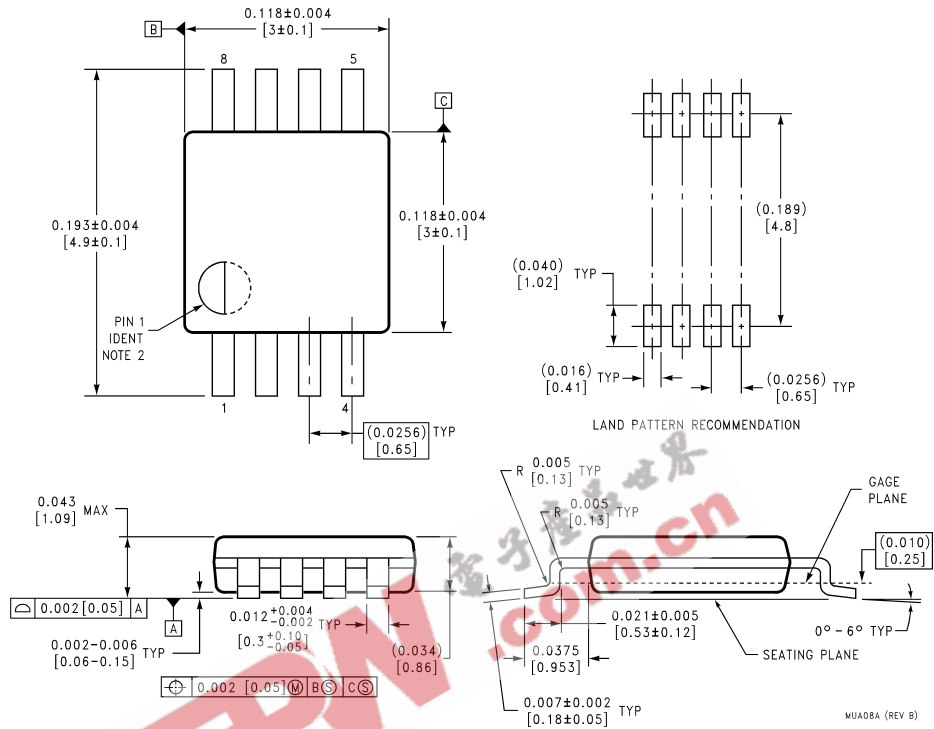

Order Number LM4881MM
NS Package Number MUA08A

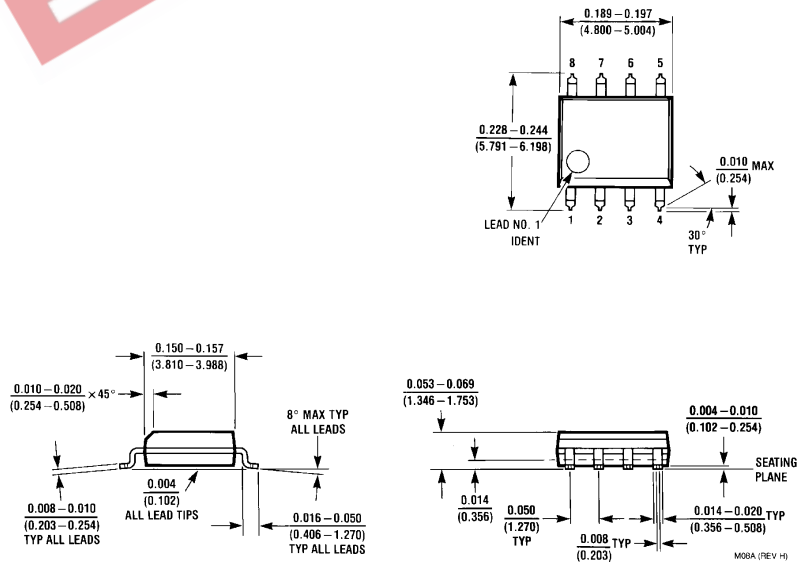

Order Number LM4881M
NS Package Number M08A

Physical Dimensions inches (millimeters) unless otherwise noted (Continued)

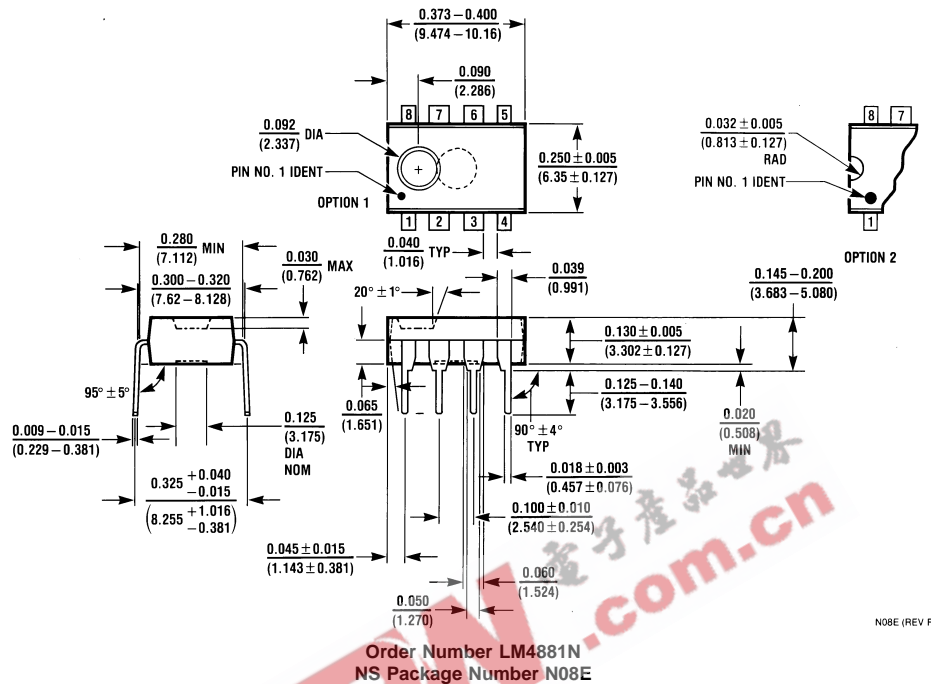

N08E (REV F)

LIFE SUPPORT POLICY

NATIONAL'S PRODUCTS ARE NOT AUTHORIZED FOR USE AS CRITICAL COMPONENTS IN LIFE SUPPORT DEVICES OR SYSTEMS WITHOUT THE EXPRESS WRITTEN APPROVAL OF THE PRESIDENT AND GENERAL COUNSEL OF NATIONAL SEMICONDUCTOR CORPORATION. As used herein:

1. Life support devices or systems are devices or systems which, (a) are intended for surgical implant into the body, or (b) support or sustain life, and whose failure to perform when properly used in accordance with instructions for use provided in the labeling, can be reasonably expected to result in a significant injury to the user.
2. A critical component is any component of a life support device or system whose failure to perform can be reasonably expected to cause the failure of the life support device or system, or to affect its safety or effectiveness.

National Semiconductor Corporation
Americas
Tel: 1-800-272-9959
Fax: 1-800-737-7018
Email: support@nsc.com
www.national.com

National Semiconductor Europe
Fax: +49 (0) 1 80-530 85 86
Email: europe.support@nsc.com
Deutsch Tel: +49 (0) 1 80-530 85 85
English Tel: +49 (0) 1 80-532 78 32
Français Tel: +49 (0) 1 80-532 93 58
Italiano Tel: +49 (0) 1 80-534 16 80

National Semiconductor Asia Pacific Customer Response Group
Tel: 65-2544466
Fax: 65-2504466
Email: sea.support@nsc.com

National Semiconductor Japan Ltd.
Tel: 81-3-5639-7560
Fax: 81-3-5639-7507