

## PROGRAMMABLE QUAD BIPOLAR OPERATIONAL AMPLIFIERS

- PROGRAMMABLE ELECTRICAL CHARACTERISTICS
- BATTERY POWERED OPERATION
- LOW SUPPLY CURRENT (250µA/amplifier)
- GAIN-BANDWIDTH PRODUCT : 1MHz
- LARGE DC VOLTAGE GAIN : 120dB
- LOW NOISE VOLTAGE : 28nV/√Hz
- WIDE POWER SUPPLY RANGE : ±1.5V to ±22V
- CLASSE AB OUTPUT STAGE. NO CROSS-OVER DISTORTION
- OVERLOAD PROTECTION FOR INPUTS AND OUTPUTS

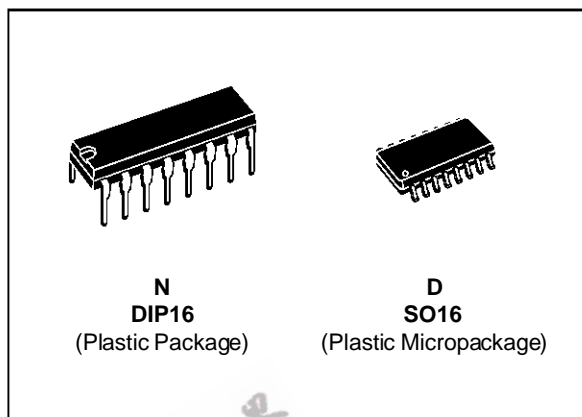

### ORDER CODES

Part Number	Temperature Range	Package	
		N	D
LM146	-55°C, +125°C	•	•
LM246	-40°C, +105°C	•	•
LM346	0°C, +70°C	•	•

**Example :** LM246N

### DESCRIPTION

The LM346 consists of four independent, high gain, internally compensated, low power programmable amplifiers. Two external resistors ( $R_{set}$ ) allow the user to program the gain-bandwidth product, slew rate, supply current, input bias current, input offset current and input noise. For example the user can trade-off supply current for bandwidth or optimize noise figure for a given source resistance. In a similar way other amplifier characteristics can be tailored to the application.

Except for the two programming pins at the end of the package the LM346 pin out is the same as the LM324 and LM348.

### PROGRAMMING EQUATIONS :

Total supply current = 1mA ( $I_{set} = 10\mu A$ )

Gain-bandwidth product = 1MHz ( $I_{set} = 10\mu A$ )

Slew rate = 0.5V/µs ( $I_{set} = 10\mu A$ )

Input bias current ≈ 30 nA ( $I_{set} = 10\mu A$ )

$I_{set}$  = current into pin 8 and pin 9

(see schematic diagram)

$$I_{set} = \frac{V_{CC}^+ - V_{CC}^- - 0.6V}{R_{set}}$$

### PIN CONNECTIONS (top view)

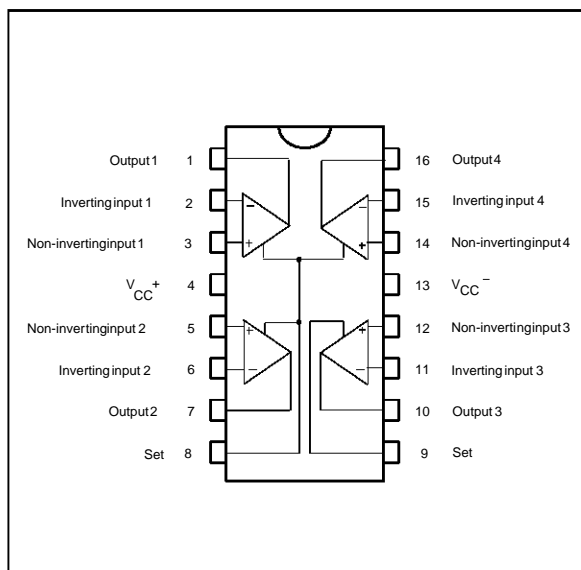

**SCHEMATIC DIAGRAM (1/4 LM146)**

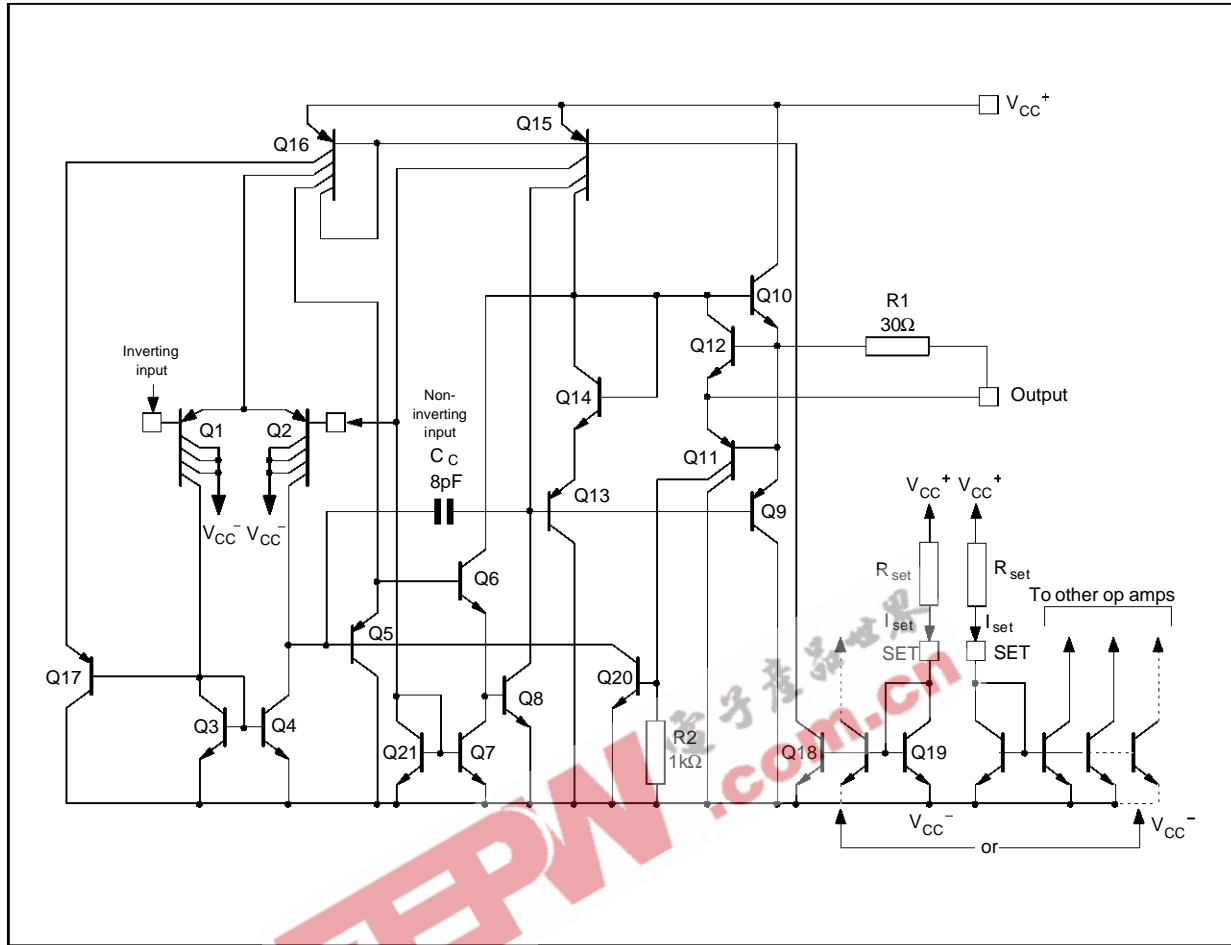

**ABSOLUTE MAXIMUM RATINGS**

Symbol	Parameter	LM146	LM246	LM346	Unit
$V_{CC}$	Supply Voltage	$\pm 22$	$\pm 22$	$\pm 22$	V
$V_i$	Input Voltage - (note 1)	$\pm 15$	$\pm 15$	$\pm 15$	V
$V_{id}$	Differential Input Voltage	$\pm 30$	$\pm 30$	$\pm 30$	V
	Output Short-circuit Duration - (note 2)	Infinite			
$P_{tot}$	Power Dissipation N/D Suffix	500			mW
$T_{oper}$	Operating Free-air Temperature Range	-55 to +125	-40 to +105	0 to +70	°C
$T_{stg}$	Storage Temperature Range	-65 to +150	-65 to +150	-65 to +150	°C

**Notes :** 1. For supply voltages less than  $\pm 15V$ , the absolute maximum input voltage is equal to the supply voltage.  
 2. Any of the amplifier outputs can be shorted to ground indefinitely ; however more than one should not be simultaneously shorted as the maximum junction temperature will be exceeded.

**ELECTRICAL CHARACTERISTICS**

V<sub>CC</sub> = ±15V, I<sub>set</sub> = 10μA, T<sub>amb</sub> = +25°C (unless otherwise specified)

Symbol	Parameter	LM146			LM246 - LM346			Unit
		Min.	Typ.	Max.	Min.	Typ.	Max.	
V <sub>io</sub>	Input Offset Voltage (R <sub>S</sub> ≤ 10kΩ) T <sub>amb</sub> = 25°C T <sub>min.</sub> ≤ T <sub>amb</sub> ≤ T <sub>max.</sub>		0.5	3 5		0.5	5 6	mV
I <sub>io</sub>	Input Offset Current T <sub>amb</sub> = 25°C T <sub>min.</sub> ≤ T <sub>amb</sub> ≤ T <sub>max.</sub>		2	20 25		2	100 100	nA
I <sub>ib</sub>	Input Bias Current T <sub>amb</sub> = 25°C T <sub>min.</sub> ≤ T <sub>amb</sub> ≤ T <sub>max.</sub>		30	100 100		30	250 250	nA
A <sub>vd</sub>	Large Signal Voltage Gain (V <sub>o</sub> = ±10V, R <sub>L</sub> = 10kΩ) T <sub>amb</sub> = 25°C T <sub>min.</sub> ≤ T <sub>amb</sub> ≤ T <sub>max.</sub>	100 50	1000		50 25	1000		V/mV
SVR	Supply Voltage Rejection Ratio (R <sub>S</sub> ≤ 10kΩ) T <sub>amb</sub> = 25°C T <sub>min.</sub> ≤ T <sub>amb</sub> ≤ T <sub>max.</sub>	80 80	110		80 80	110		dB
I <sub>CC</sub>	Supply Current, all Amp, no Load T <sub>amb</sub> = 25°C T <sub>min.</sub> ≤ T <sub>amb</sub> ≤ T <sub>max.</sub>		1	2 2		1	2 2	mA
V <sub>icm</sub>	Input Common Mode Voltage Range T <sub>amb</sub> = 25°C T <sub>min.</sub> ≤ T <sub>amb</sub> ≤ T <sub>max.</sub>	±13.5 ±13.5			±13.5 ±13.5			V
CMR	Common Mode Rejection Ratio (R <sub>S</sub> ≤ 10kΩ) T <sub>amb</sub> = 25°C T <sub>min.</sub> ≤ T <sub>amb</sub> ≤ T <sub>max.</sub>	80 70	110		80 70	110		dB
I <sub>os</sub>	Output Short-circuit Current T <sub>amb</sub> = 25°C T <sub>min.</sub> ≤ T <sub>amb</sub> ≤ T <sub>max.</sub>	10 4	20	30 35	10 4	20	30 35	mA
±V <sub>opp</sub>	Output Voltage Swing (R <sub>L</sub> = 10kΩ) T <sub>amb</sub> = 25°C T <sub>min.</sub> ≤ T <sub>amb</sub> ≤ T <sub>max.</sub>	12 12	14		12 12	14		V
SR	Slew Rate (V <sub>I</sub> = ±10V, R <sub>L</sub> = 10kΩ, C <sub>L</sub> = 100pF, unity Gain)	0.3	0.5		0.3	0.5		V/μs
R <sub>I</sub>	Input Resistance		1			1		MΩ
C <sub>I</sub>	Input Capacitance		2			2		pF
V <sub>o1</sub> /V <sub>o2</sub>	Channel Separation (R <sub>L</sub> = 10kΩ, V <sub>o</sub> = 12V <sub>pp</sub> )		120			120		dB
GBP	Gain Bandwidth Product (V <sub>I</sub> = 10 mV, R <sub>L</sub> = 10kΩ, C <sub>L</sub> = 100pF f = 100kHz)	0.8	1		0.5	1		MHz
THD	Total Harmonic Distortion (f = 1kHz, A <sub>v</sub> = 20dB, R <sub>L</sub> = 10kΩ C <sub>L</sub> = 100pF, v <sub>o</sub> = 2V <sub>pp</sub> )		0.015			0.015		%
e <sub>n</sub>	Equivalent Input Noise Voltage (f = 1kHz, R <sub>S</sub> = 100Ω)		28			28		$\frac{nV}{\sqrt{Hz}}$

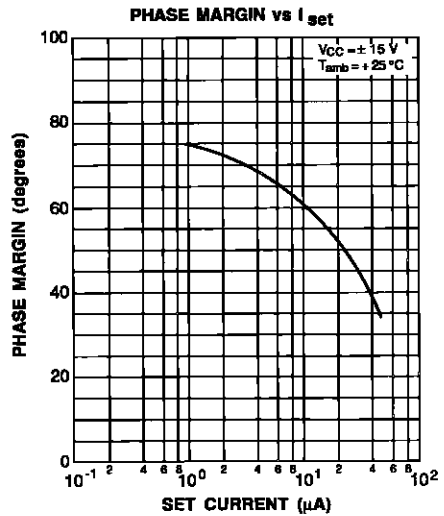
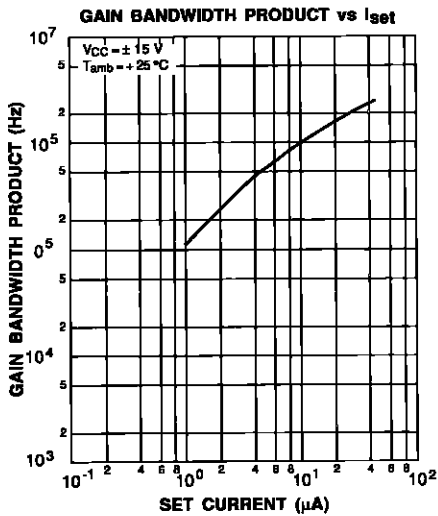
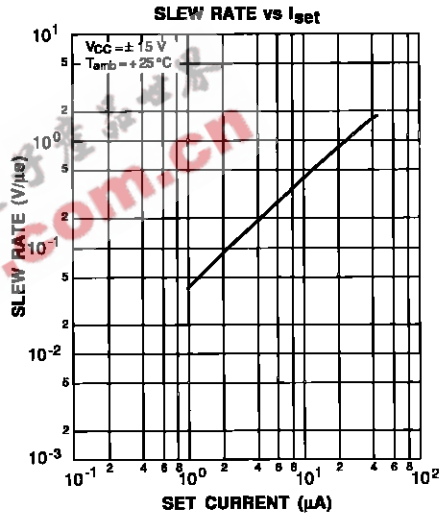
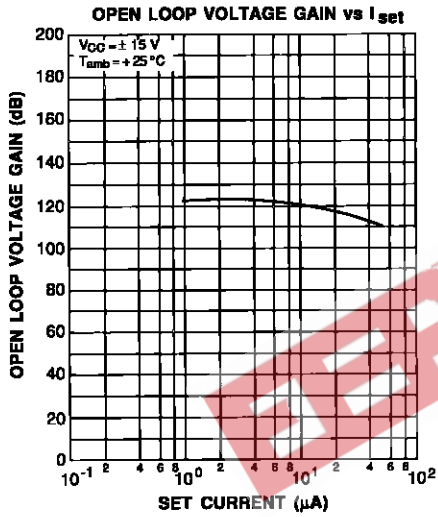
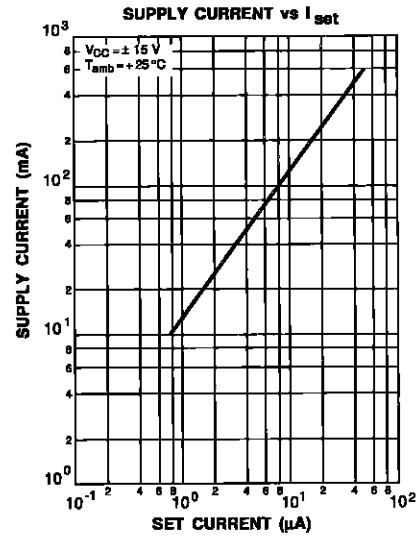
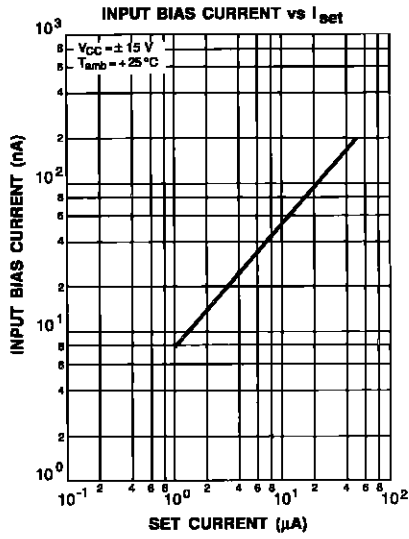

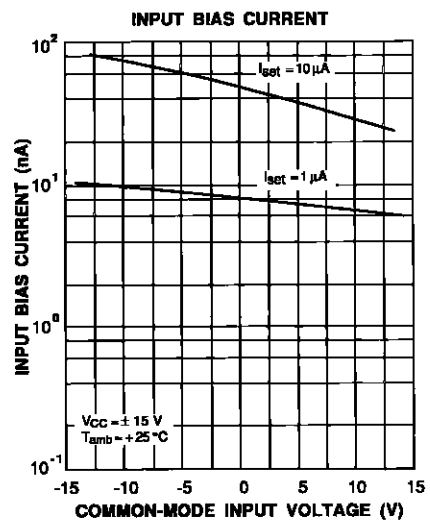
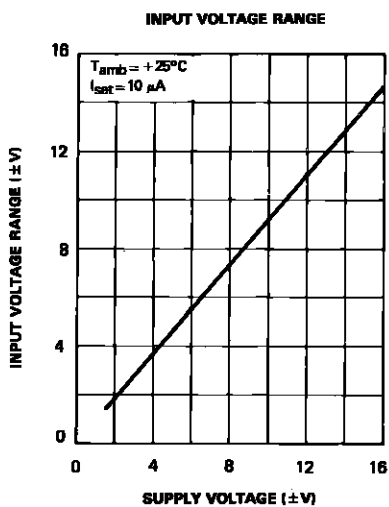
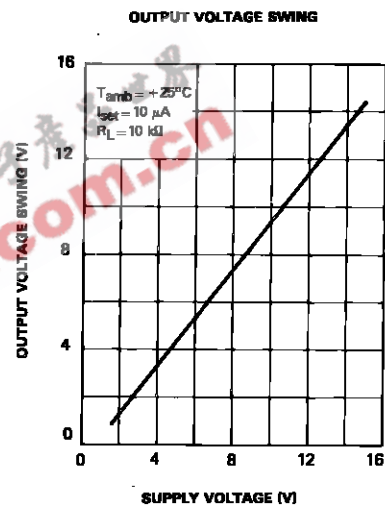
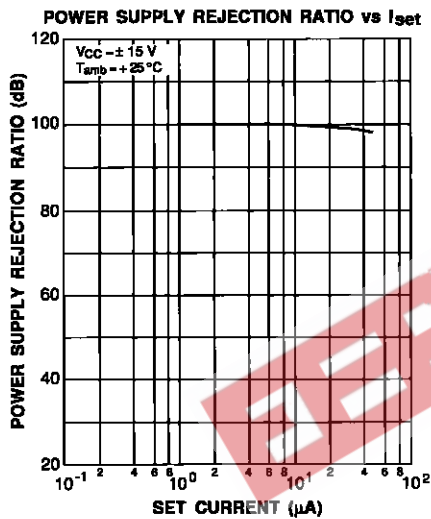
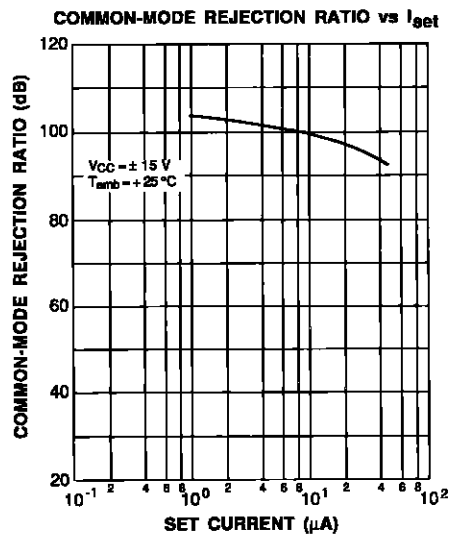
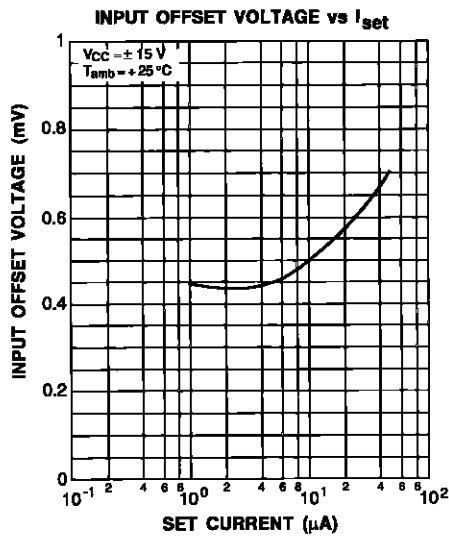

INPUT BIAS CURRENT vs TEMPERATURE

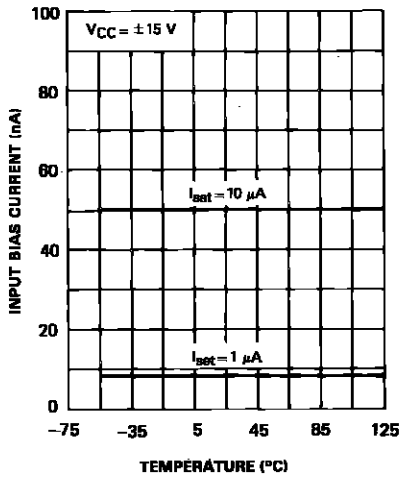

INPUT OFFSET CURRENT vs TEMPERATURE

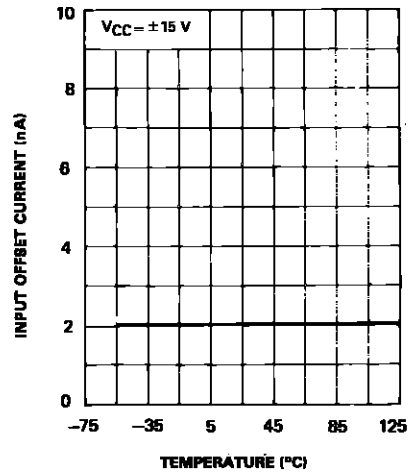

SUPPLY CURRENT vs TEMPERATURE

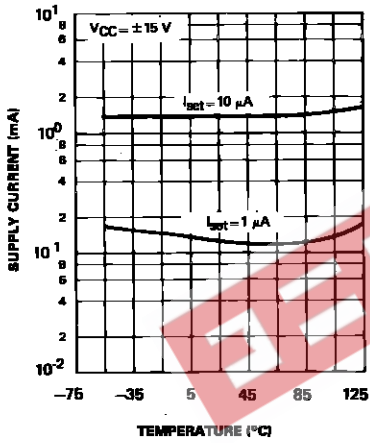

OPEN LOOP VOLTAGE GAIN vs TEMPERATURE

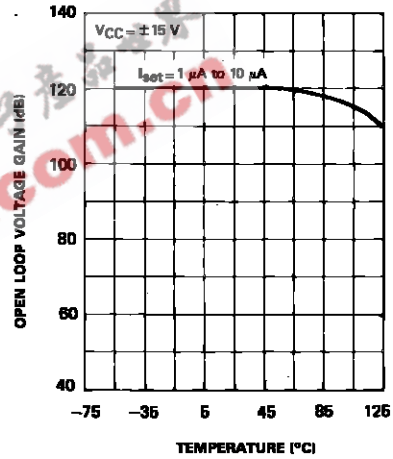

GAIN BANDWIDTH PRODUCT vs TEMPERATURE

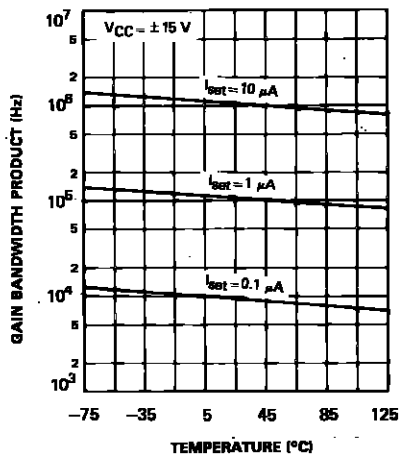

SLEW RATE vs TEMPERATURE

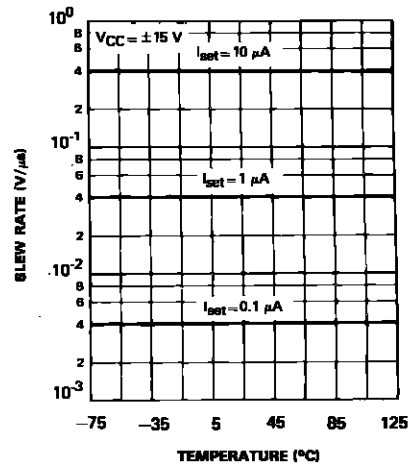

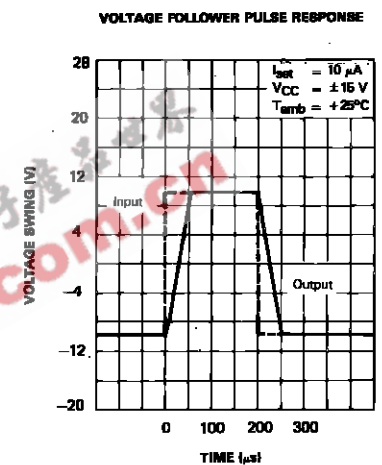
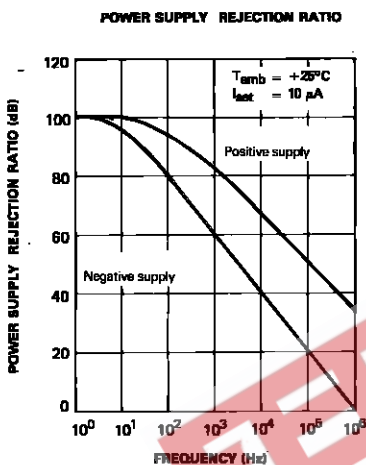
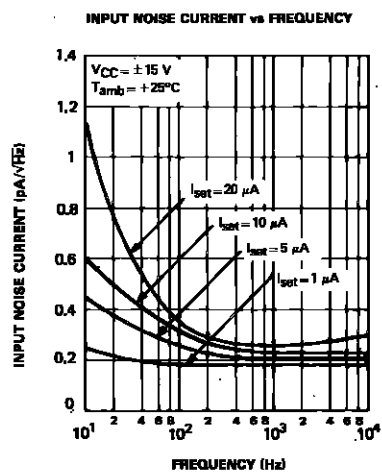
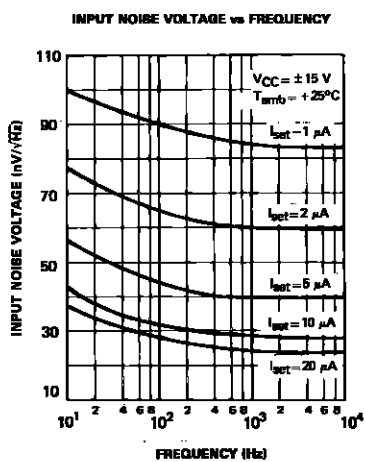

**VOLTAGE FOLLOWER TRANSIENT RESPONSE**

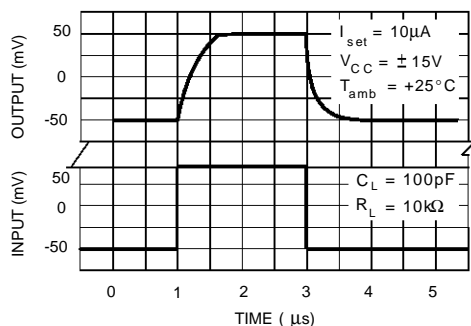

**TRANSIENT RESPONSE TEST CIRCUIT**

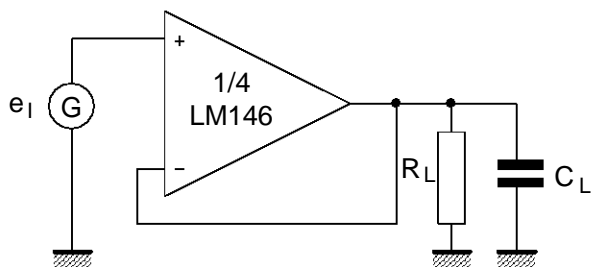

**PACKAGE MECHANICAL DATA**  
16 PINS - PLASTIC DIP

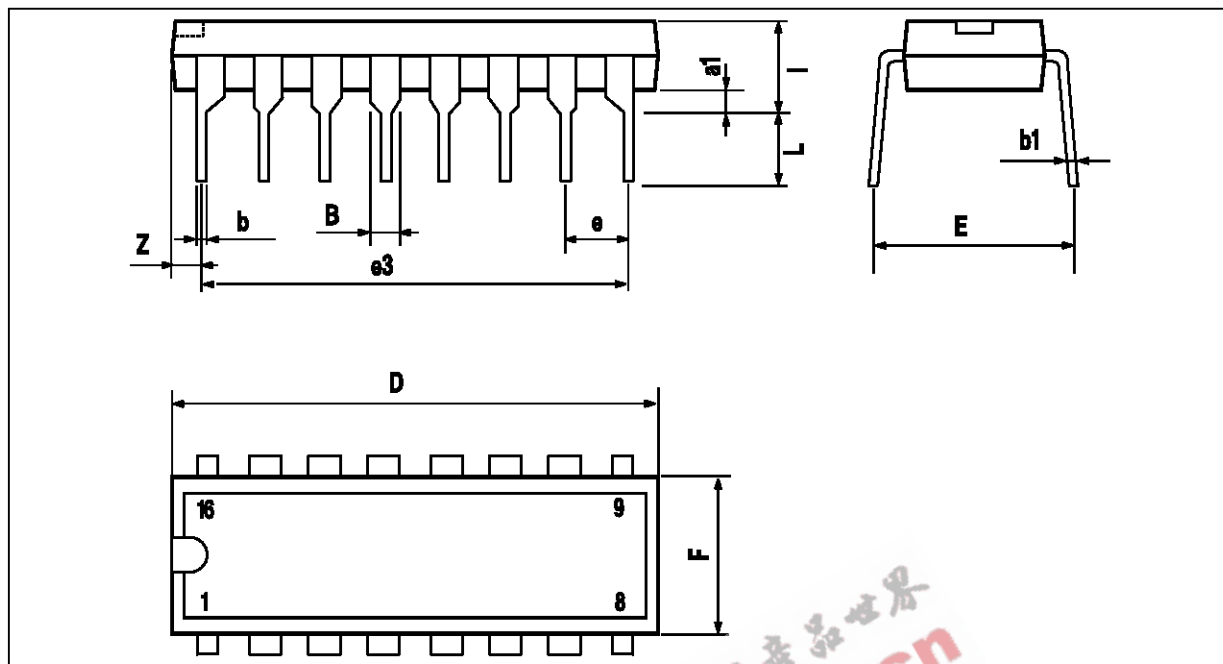

PM-DIP16EPS

Dimensions	Millimeters			Inches		
	Min.	Typ.	Max.	Min.	Typ.	Max.
a1	0.51			0.020		
B	0.77		1.65	0.030		0.065
b		0.5			0.020	
b1		0.25			0.010	
D			20			0.787
E		8.5			0.335	
e		2.54			0.100	
e3		17.78			0.700	
F			7.1			0.280
i			5.1			0.201
L		3.3			0.130	
Z			1.27			0.050

DIP16.TBL



**PACKAGE MECHANICAL DATA**  
16 PINS - PLASTIC MICROPACKAGE (SO)

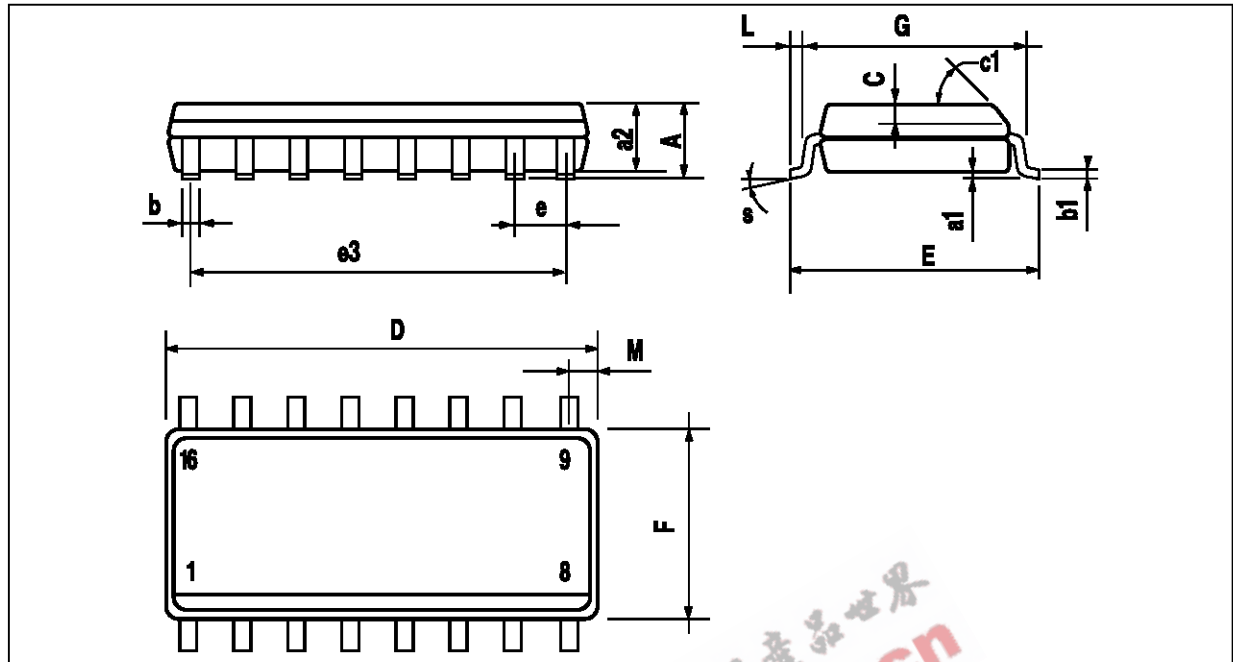

PM-SO16EPS

Dimensions	Millimeters			Inches		
	Min.	Typ.	Max.	Min.	Typ.	Max.
A			1.75			0.069
a1	0.1		0.2	0.004		0.008
a2			1.6			0.063
b	0.35		0.46	0.014		0.018
b1	0.19		0.25	0.007		0.010
C		0.5			0.020	
c1	45° (typ.)					
D	9.8		10	0.386		0.394
E	5.8		6.2	0.228		0.244
e		1.27			0.050	
e3		8.89			0.350	
F	3.8		4.0	0.150		0.157
G	4.6		5.3	0.181		0.209

SO16.TBL

Information furnished is believed to be accurate and reliable. However, SGS-THOMSON Microelectronics assumes no responsibility for the consequences of use of such information nor for any infringement of patents or other rights of third parties which may result from its use. No license is granted by implication or otherwise under any patent or patent rights of SGS-THOMSON Microelectronics. Specification mentioned in this publication are subject to change without notice. This publication supersedes and replaces all information previously supplied. SGS-THOMSON Microelectronics products are not authorized for use as critical components in life support devices or systems without express written approval of SGS-THOMSON Microelectronics.

© 1997 SGS-THOMSON Microelectronics – Printed in Italy – All Rights Reserved

SGS-THOMSON Microelectronics GROUP OF COMPANIES  
Australia - Brazil - Canada - China - France - Germany - Hong Kong - Italy - Japan - Korea - Malaysia - Malta - Morocco  
The Netherlands - Singapore - Spain - Sweden - Switzerland - Taiwan - Thailand - United Kingdom - U.S.A.

ORDER CODE :