

HIGH SPEED DUAL COMPARATORS

- TWO INDEPENDENT COMPARATORS
- OPERATES FROM A SINGLE +5V SUPPLY
- TYPICALLY 80ns RESPONSE TIME AT $\pm 15V$
- MINIMUM FAN-OUT OF 2 EACH SIDE
- MAXIMUM INPUT CURRENT OF $1\mu A$ OVER OPERATING TEMPERATURE RANGE
- INPUTS AND OUTPUTS CAN BE ISOLATED FROM SYSTEM GROUND
- HIGH COMMON-MODE SLEW RATE

DESCRIPTION

These products are precision high speed dual comparators designed to operate over a wide range of supply voltages down to a single 5V logic supply and ground and have low input currents and high gains.

The open collector of the output stage makes compatible with TTL as well as capable of driving lamps and relays at currents up to 25mA.

Although designed primarily for applications requiring operation from digital logic supplies, are fully specified for power supplies up to $\pm 15V$.

They feature faster response than the LM111 at the expense of higher power dissipation. However, the high speed, wide operating voltage range and low package count make the much more versatile.

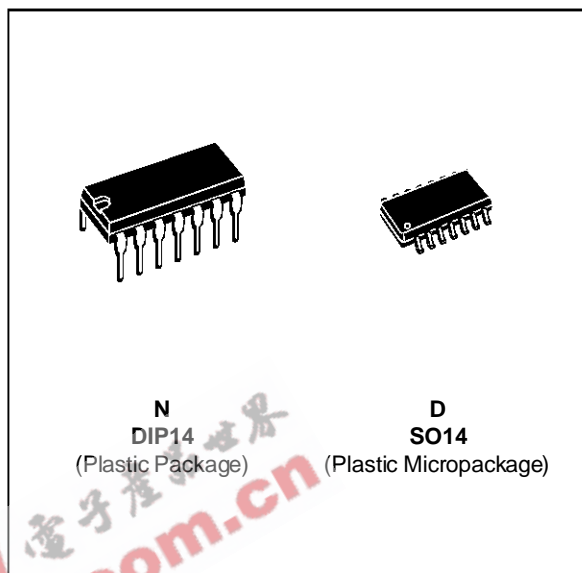

ORDER CODES

Part Number	Temperature Range	Package	
		N	D
LM119	-55, +125°C	•	•
LM219	-40, +105°C	•	•
LM319	0, +70°C	•	•

Example : LM219N

PIN CONNECTIONS (top view)

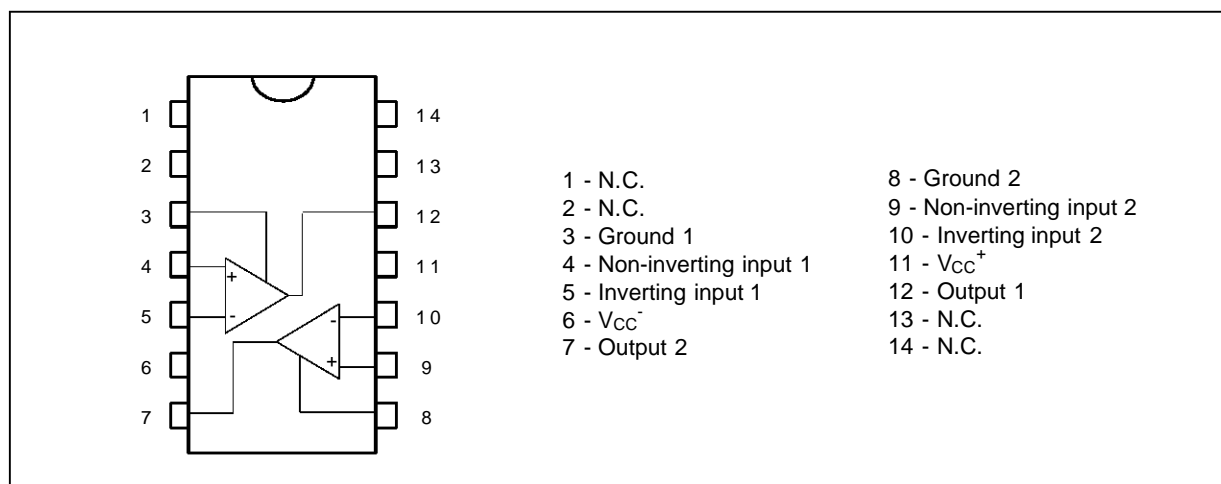

LM119 - LM219 - LM319

SCHEMATIC DIAGRAM

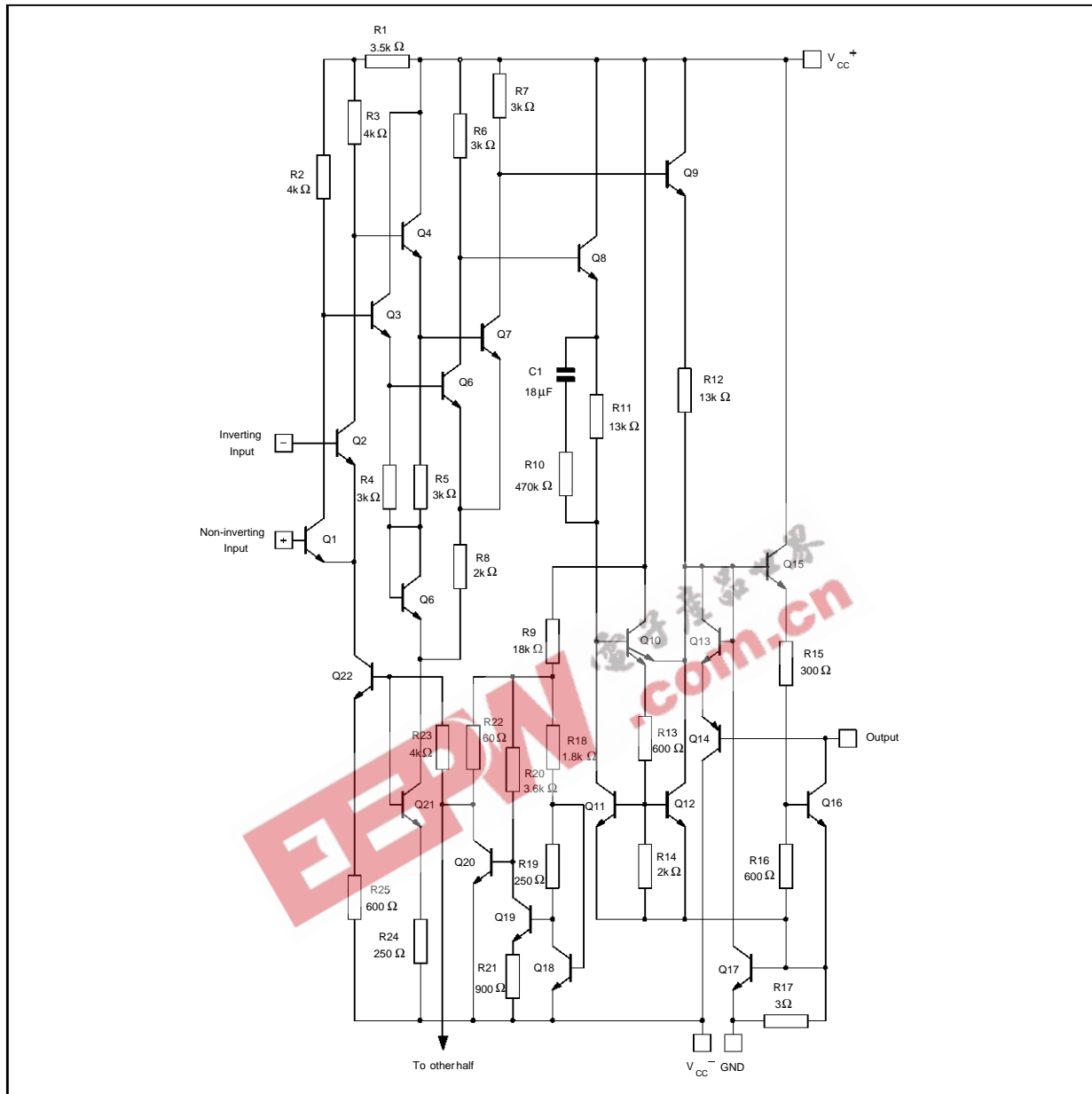

ABSOLUTE MAXIMUM RATINGS

Symbol	Parameter	LM119	LM219	LM319	Unit
$V_O - V_{CC}^-$	Output to Negative Supply Voltage	36	36	36	V
V_{CC}^-	Negative Supply Voltage	25	25	25	V
V_{CC}^+	Positive Supply Voltage	18	18	18	V
V_{id}	Differential Input Voltage	± 5	± 5	± 5	V
V_i	Input Voltage – (note 1)	± 15	± 15	± 15	V
P_{tot}	Power Dissipation	500	500	500	mW
T_{oper}	Operating Free-air Temperature Range	-55 to +125	-40 to +105	0 to +70	$^{\circ}C$
T_{stg}	Storage Temperature Range	-65 to +150	-65 to +150	-65 to +150	$^{\circ}C$

ELECTRICAL CHARACTERISTICS

V_{CC} = ±15V, T_{amb} = 25°C (unless otherwise specified)

Symbol	Parameter	LM119 - LM219			LM319			Unit
		Min.	Typ.	Max.	Min.	Typ.	Max.	
V _{io}	Input Offset Voltage (R _S ≤ 5kΩ) – (note 2) T _{amb} = +25°C T _{min.} ≤ T _{amb} ≤ T _{max.}		0.7	4 7		2	8 10	mV
I _{io}	Input Offset Current – (note 2) T _{amb} = +25°C T _{min.} ≤ T _{amb} ≤ T _{max.}		30	75 100		80	200 300	nA
I _{ib}	Input Bias Current – (note 2) T _{amb} = +25°C T _{min.} ≤ T _{amb} ≤ T _{max.}		150	500 1000		250	1000 1200	nA
A _{vd}	Large Signal Voltage Gain	10	40		8	40		V/mV
I _{CC} ⁺	Positive Supply Current V _{CC} = ±15V V _{CC} ⁺ = +5V, V _{CC} ⁻ = 0V		8 4.3	11.5		8 4.3	12.5	mA
I _{CC} ⁻	Negative Supply Current		3	4.5		3	5	mA
V _{icm}	Input Common Mode Voltage Range V _{CC} = ±15V V _{CC} ⁺ = +5V, V _{CC} ⁻ = 0V	±12 1	±13	3	±12 1	±13	3	V
V _{id}	Differential Input Voltage			±5			±5	V
V _{OL}	Low Level Output Voltage T _{amb} = +25°C, I _O = 25mA V _i ≤ -5mV V _i ≤ -10mV T _{min.} ≤ T _{amb} ≤ T _{max.} V _{CC} ⁺ ≥ +4.5V, V _{CC} ⁻ = 0V, I _{O(sink)} < 3.2mA V _i ≤ -6mV V _i ≤ -10mV		0.75 0.23	1.5 0.4		0.75 0.3	1.5 0.4	V
I _{OH}	High Level Output Current (V _O = +35V) T _{amb} = +25°C V _i ≥ 5mV V _i ≥ 10mV T _{min.} ≤ T _{amb} ≤ T _{max.} V _i ≥ 5mV		0.2 1	2 10		0.2	10	μA
t _{re}	Response Time – (note 3)		80			80		ns

- Notes :**
- For supply voltages less than ±15V the absolute maximum input voltage is equal to the supply voltage.
 - These specifications apply for V_{CC} = ±15V, unless otherwise stated. The offset voltage, offset current and bias current specifications apply for any supply voltage from a single +5V supply up to ±15V supplies. The offset voltages and offset current given are the maximum values required to drive the output down to 1V or up to +14V with a 1mA load current. Thus, these parameters define an error band and take into account the worst case effects of voltage gain and input impedance.
 - The response time specified is for a 100mV input step with 5mV overdrive.

LM119-LM219

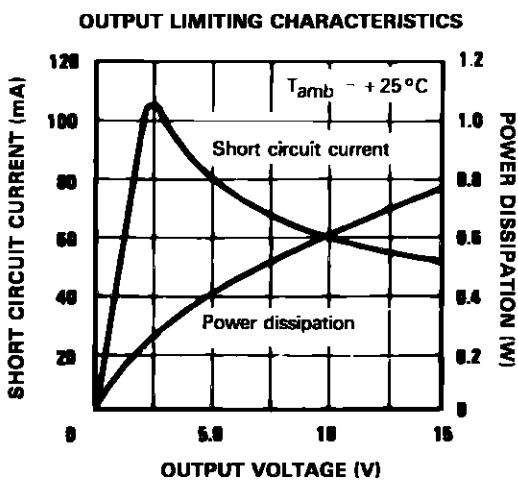
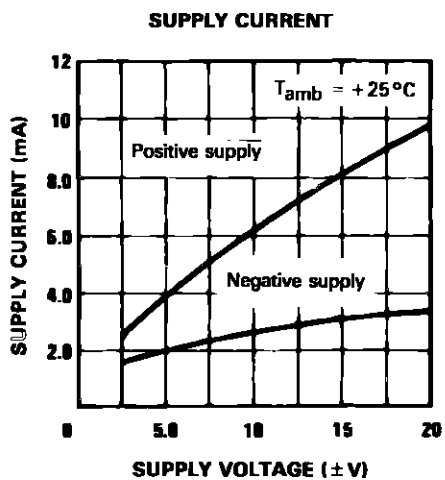
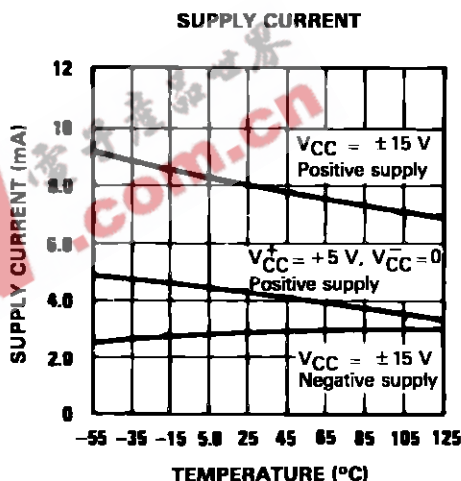
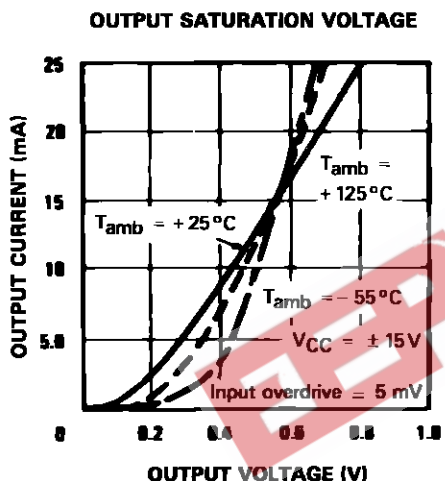
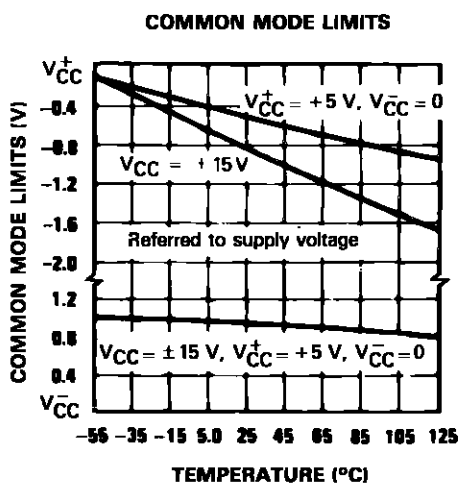
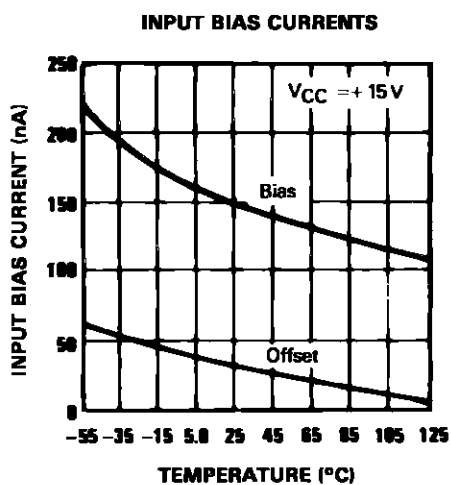

LM319

INPUT BIAS CURRENTS

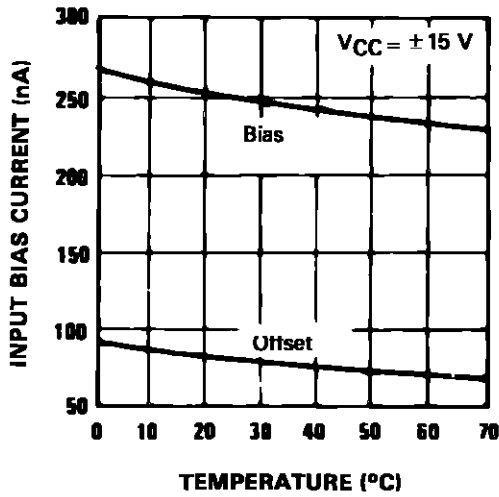

COMMON MODE LIMITS

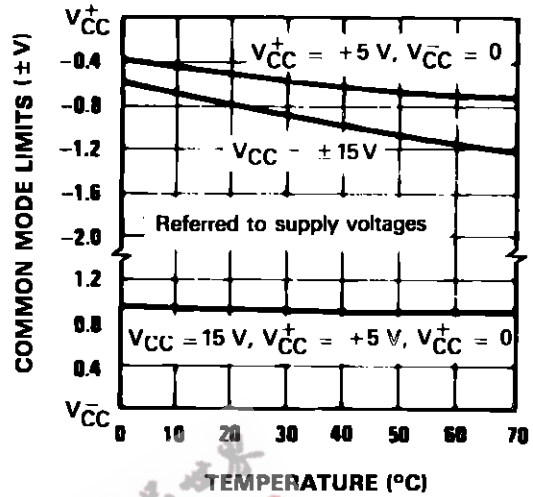

OUTPUT SATURATION VOLTAGE

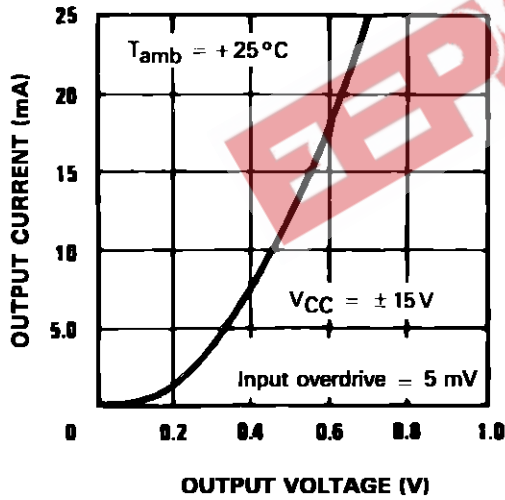

SUPPLY CURRENT

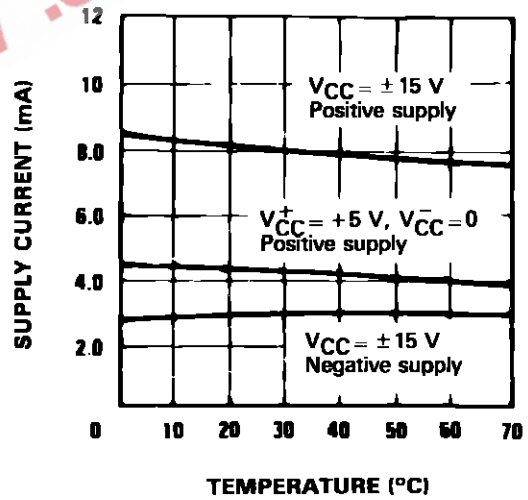

TRANSFER FUNCTION

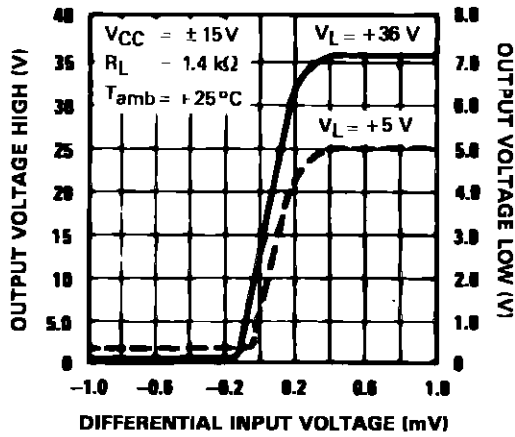

INPUT CHARACTERISTICS

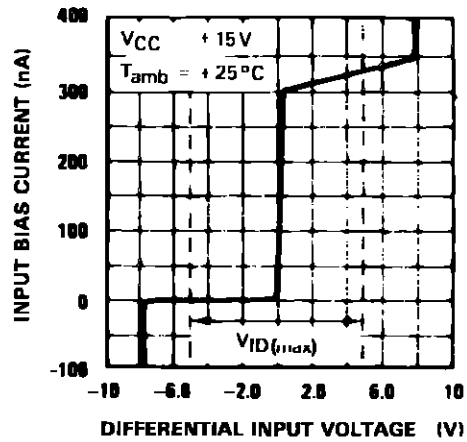

RESPONSE TIME FOR VARIOUS INPUT OVERDRIVES

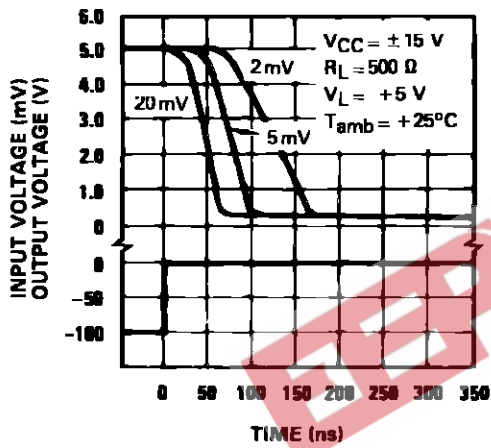

RESPONSE TIME FOR VARIOUS INPUT OVERDRIVES

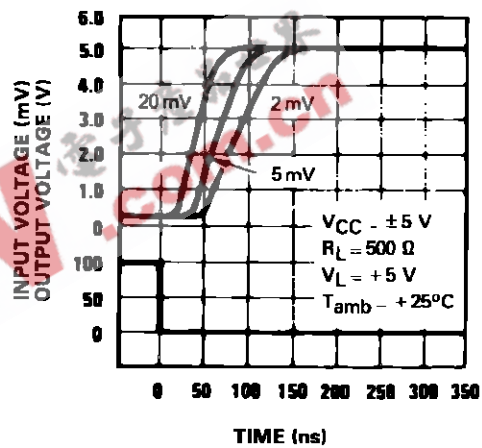

RESPONSE TIME FOR VARIOUS INPUT OVERDRIVES

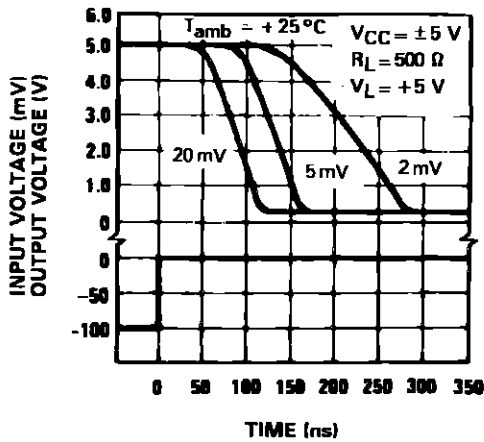

RESPONSE TIME FOR VARIOUS INPUT OVERDRIVES

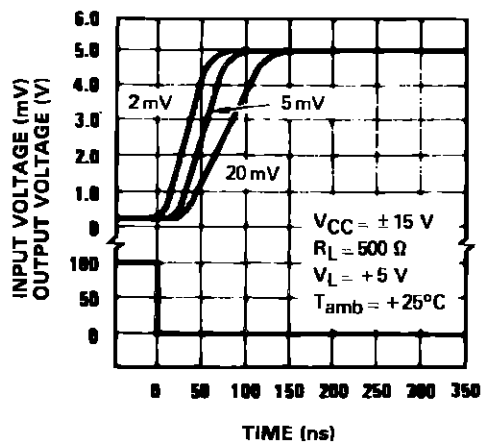

TYPICAL APPLICATION DIAGRAMS

RELAY DRIVER

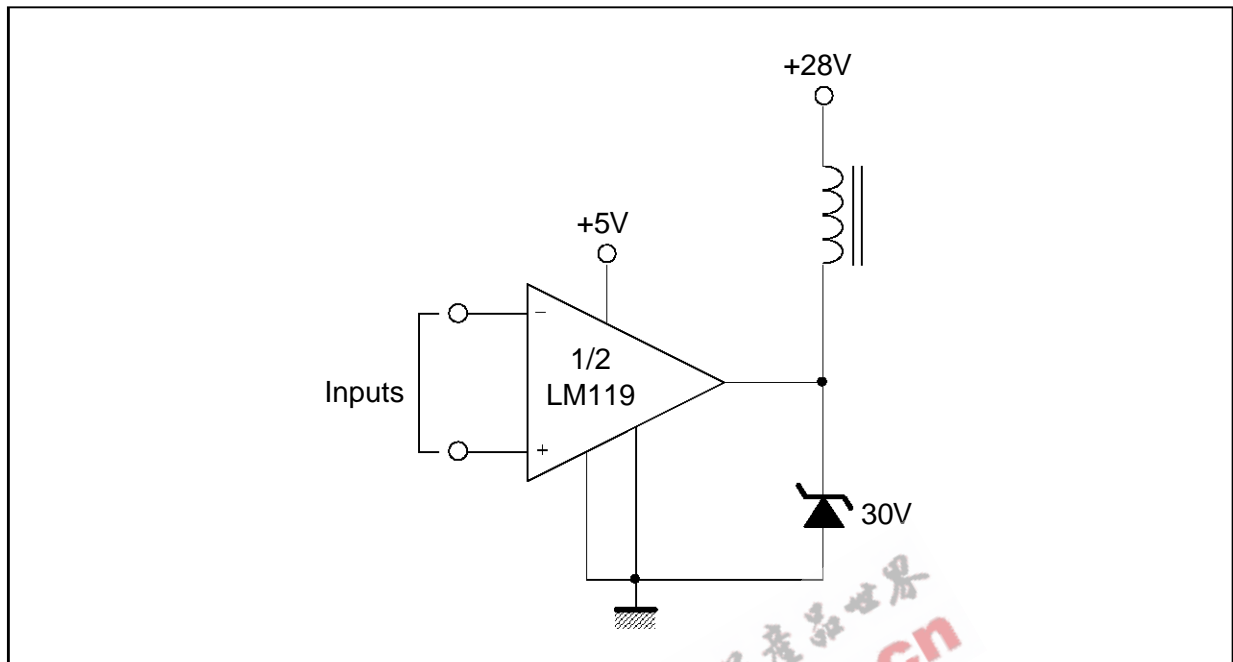

WINDOW DETECTOR

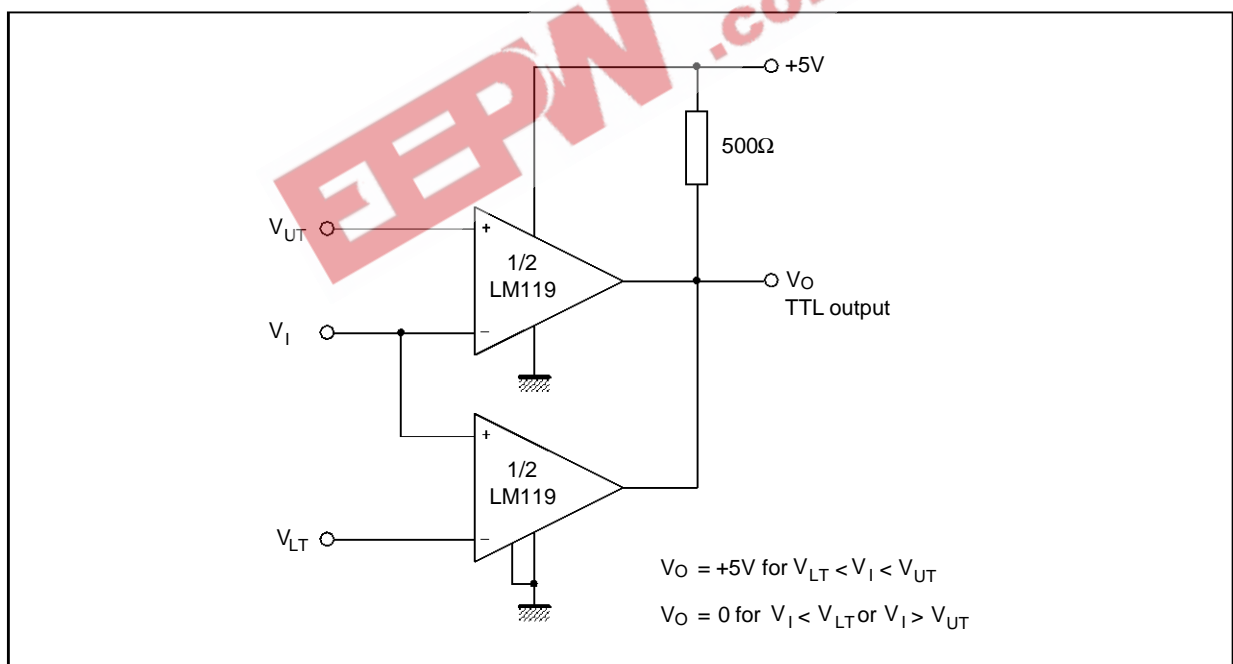

LM119 - LM219 - LM319

PACKAGE MECHANICAL DATA
14 PINS – PLASTIC DIP

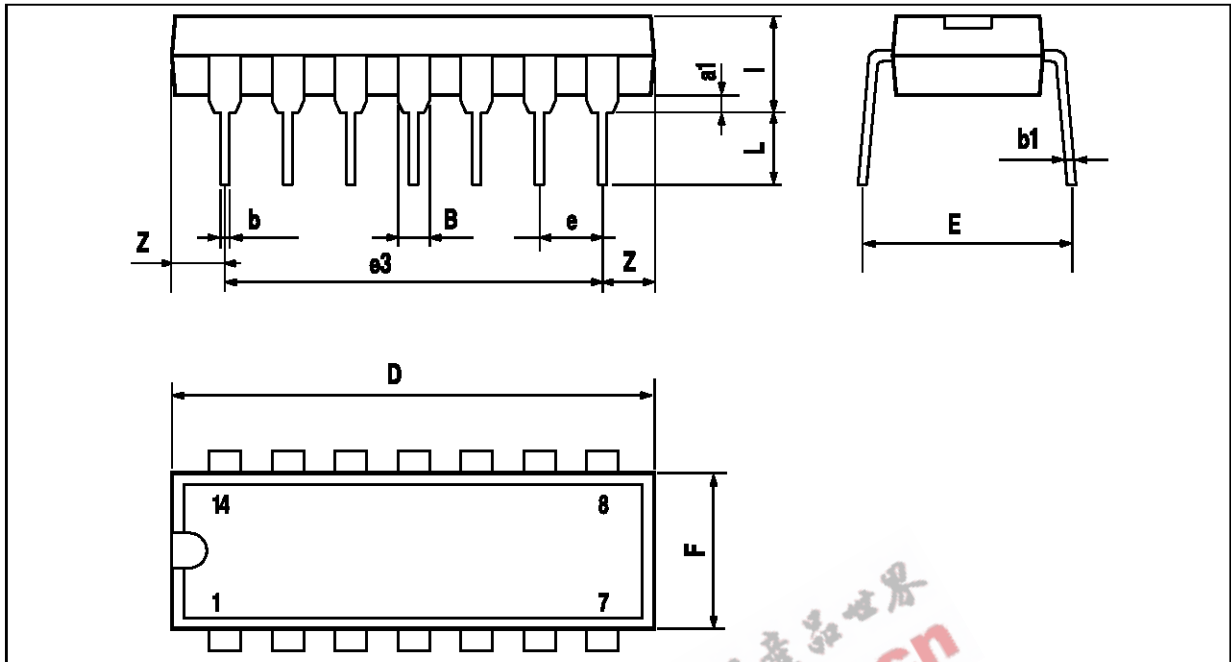

PM-DIP14.EPS

Dimensions	Millimeters			Inches		
	Min.	Typ.	Max.	Min.	Typ.	Max.
a1	0.51			0.020		
B	1.39		1.65	0.055		0.065
b		0.5			0.020	
b1		0.25			0.010	
D			20			0.787
E		8.5			0.335	
e		2.54			0.100	
e3		15.24			0.600	
F			7.1			0.280
i			5.1			0.201
L		3.3			0.130	
Z	1.27		2.54	0.050		0.100

DIP14.TBL

PACKAGE MECHANICAL DATA
 14 PINS – PLASTIC MICROPACKAGE (SO)

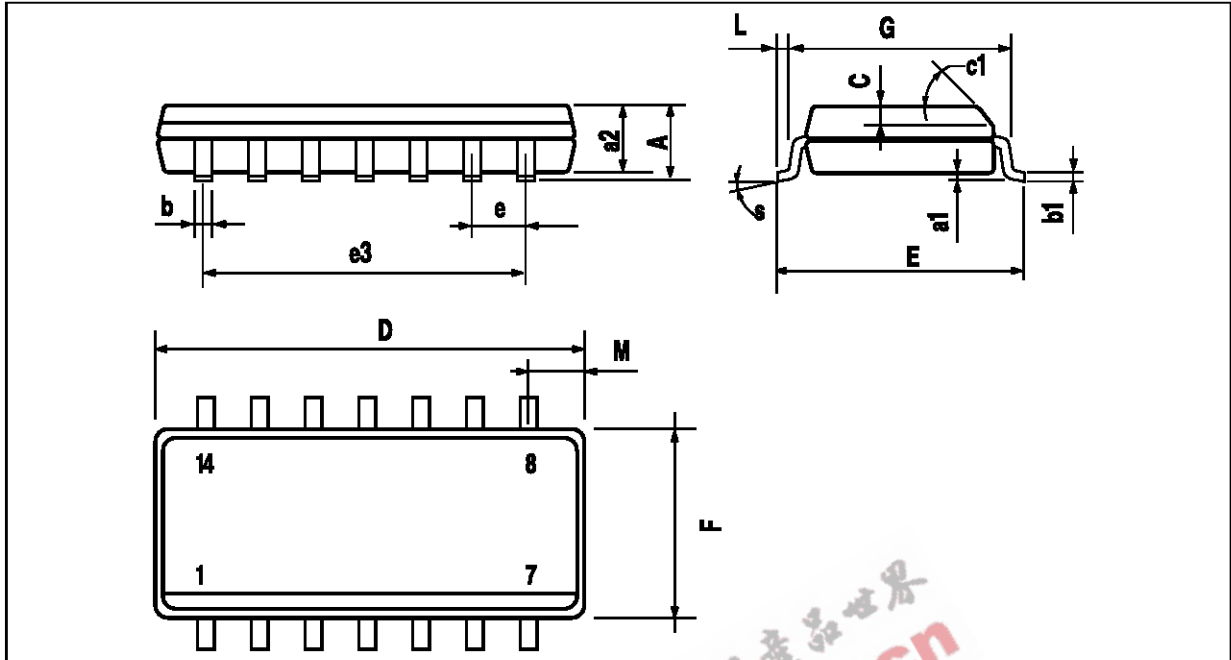

Dimensions	Millimeters			Inches		
	Min.	Typ.	Max.	Min.	Typ.	Max.
A			1.75			0.069
a1	0.1		0.2	0.004		0.008
a2			1.6			0.063
b	0.35		0.46	0.014		0.018
b1	0.19		0.25	0.007		0.010
C		0.5			0.020	
c1	45° (typ.)					
D	8.55		8.75	0.336		0.334
E	5.8		6.2	0.228		0.244
e		1.27			0.050	
e3		7.62			0.300	
F	3.8		4.0	0.150		0.157
G	4.6		5.3	0.181		0.208
L	0.5		1.27	0.020		0.050
M			0.68			0.027
S	8° (max.)					

Information furnished is believed to be accurate and reliable. However, SGS-THOMSON Microelectronics assumes no responsibility for the consequences of use of such information nor for any infringement of patents or other rights of third parties which may result from its use. No license is granted by implication or otherwise under any patent or patent rights of SGS-THOMSON Microelectronics. Specification mentioned in this publication are subject to change without notice. This publication supersedes and replaces all information previously supplied. SGS-THOMSON Microelectronics products are not authorized for use as critical components in life support devices or systems without express written approval of SGS-THOMSON Microelectronics.

© 1997 SGS-THOMSON Microelectronics – Printed in Italy – All Rights Reserved

SGS-THOMSON Microelectronics GROUP OF COMPANIES
 Australia - Brazil - Canada - China - France - Germany - Hong Kong - Italy - Japan - Korea - Malaysia - Malta - Morocco
 The Netherlands - Singapore - Spain - Sweden - Switzerland - Taiwan - Thailand - United Kingdom - U.S.A.