

# LM78 Microprocessor System Hardware Monitor

## General Description

The LM78 is a highly integrated Data Acquisition system for hardware monitoring of servers, Personal Computers, or virtually any microprocessor based system. In a PC, the LM78 can be used to monitor power supply voltages, temperatures, and fan speeds. Actual values for these inputs can be read at any time, and programmable WATCHDOG limits in the LM78 activate a fully programmable and maskable interrupt system with two outputs.

The LM78 has an on-chip temperature sensor, 5 positive analog inputs, two inverting inputs (for monitoring negative voltages), and an 8-bit ADC. An input is provided for the overtemperature outputs of additional temperature sensors and this is linked to the interrupt system. The LM78 provides inputs for three fan tachometer outputs. Additional inputs are provided for Chassis Intrusion detection circuits, VID monitor inputs, and chainable interrupt. The LM78 provides both ISA and Serial Bus interfaces. A 32-byte auto-increment RAM is provided for POST (Power On Self Test) code storage.

## Applications

- System Hardware Monitoring for Servers and PCs
- Office Electronics
- Electronic Test Equipment and Instrumentation

## Features

- Temperature sensing
- 5 positive voltage inputs
- 2 op amps for negative voltage monitoring
- 3 fan speed monitoring inputs
- Input for additional temperature sensors
- Chassis Intrusion Detector input
- WATCHDOG comparison of all monitored values
- POST code storage RAM
- ISA and I<sup>2</sup>C™ Serial Bus interfaces

## Key Specifications

■ Voltage monitoring accuracy	±1% (max)
■ Temperature Accuracy -10°C to +100°C	±3°C (max)
■ Supply Voltage	5V
■ Supply Current	Operating: 1 mA typ Shutdown: 10 µA typ
■ ADC Resolution	8 Bits

## Typical Application

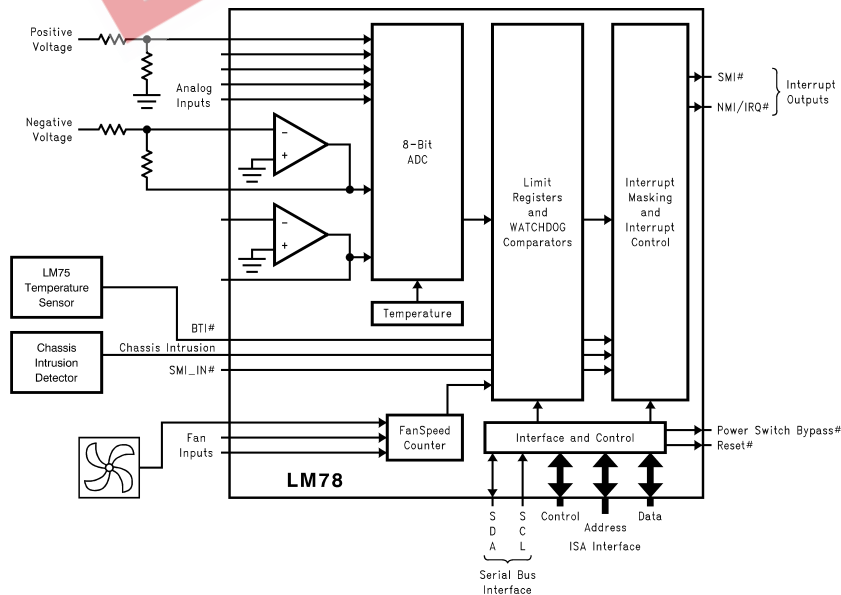

# indicates Active Low ("Not")

DS012873-1

I<sup>2</sup>C® is a registered trademark of the Phillips Corporation.

### Ordering Information

Temperature Range -10°C ≤ T <sub>A</sub> ≤ +100°C		Package VGZ44A
Order Number LM78CCVF	Device Marking LM78CCVF-J	

### Connection Diagram

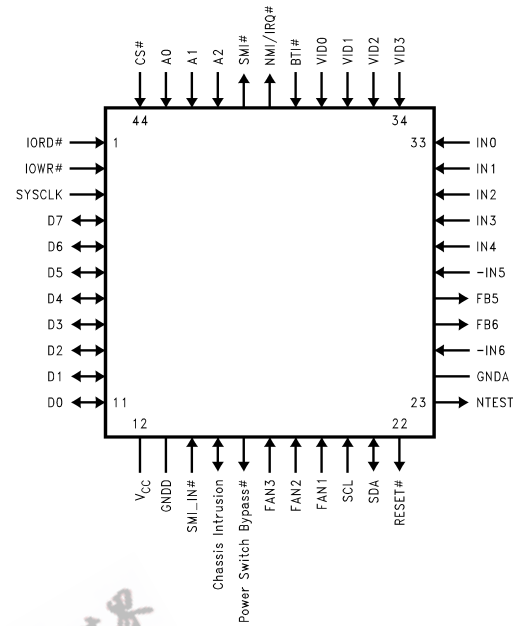

DS012873-2

### Block Diagram

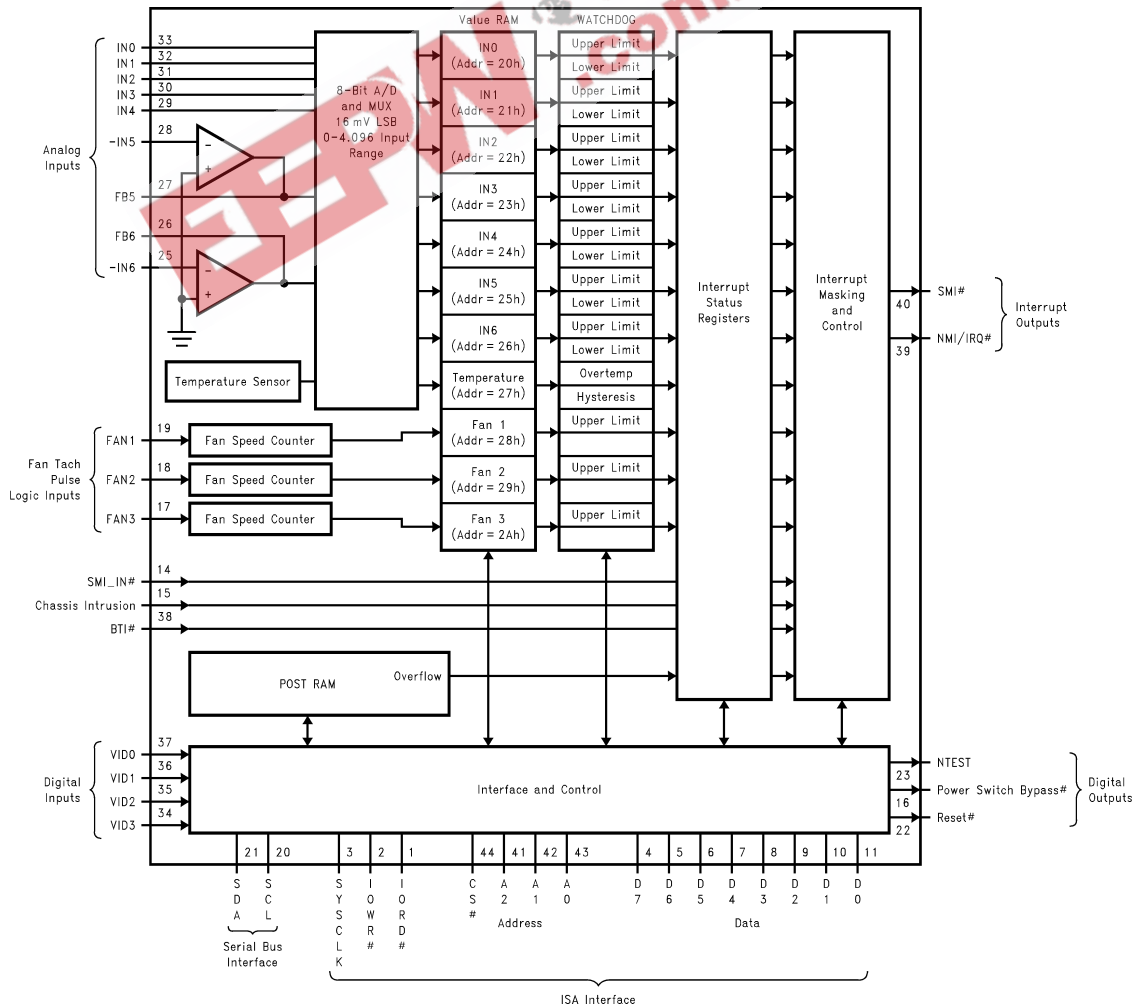

DS012873-3

## Pin Descriptions

Pin Name(s)	Pin Number	Number of Pins	Type	Description
$\overline{\text{IORD}}$	1	1	Digital Input	An active low standard ISA bus I/O Read Control.
$\overline{\text{IOWR}}$	2	1	Digital Input	An active low standard ISA bus I/O Write Control.
SYSCLK	3	1	Digital Input	The reference clock for the ISA bus. Typically ranges from 4.167 MHz to 8.33 MHz. The minimum clock frequency this input can handle is 1 Hz.
D7–D0	4–11	8	Digital I/O	Bi-directional ISA bus Data lines. D0 corresponds to the low order bit, with D7 the high order bit.
V <sub>CC</sub> (+5V)	12	1	POWER	+5V V <sub>CC</sub> power. Bypass with the parallel combination of 10 $\mu\text{F}$ (electrolytic or tantalum) and 0.1 $\mu\text{F}$ (ceramic) bypass capacitors.
GNDD	13	1	GROUND	Internally connected to all digital circuitry.
$\overline{\text{SMI\_IN}}$	14	1	Digital Input	Chainable $\overline{\text{SMI}}$ (System Management Interrupt) Input. This is an active low input that propagates the $\overline{\text{SMI}}$ signal to the $\overline{\text{SMI}}$ output of the LM78 via $\overline{\text{SMI}}$ Mask Register Bit 6 and $\overline{\text{SMI}}$ enable Bit 1 of the Configuration Register.
Chassis Intrusion	15	1	Digital I/O	An active high input from an external circuit which latches a Chassis Intrusion event. This line can go high without any clamping action regardless of the powered state of the LM78. The LM78 provides an internal open drain on this line, controlled by Bit 7 of NMI Mask Register 2, to provide a minimum 20 ms reset of this line.
Power Switch Bypass	16	1	Digital Output	An active low push-pull output intended to drive an external P-channel power MOSFET for software power control.
FAN3–FAN1	17–19	3	Digital Input	0V to +5V amplitude fan tachometer input.
SCL	20	1	Digital Input	Serial Bus Clock.
SDA	21	1	Digital I/O	Serial Bus bidirectional Data.
$\overline{\text{RESET}}$	22	1	Digital Output	Master Reset, 5 mA driver (open drain), active low output with a 20 ms minimum pulse width. Available when enabled via Bit 7 in $\overline{\text{SMI}}$ Mask Register 2.
NTEST	23	1	Test Output	NAND Tree totem-pole output that provides board-level connectivity testing. Refer to Section 11.0 on NAND Tree testing.
GNDA	24	1	GROUND	Internally connected to all analog circuitry. The ground reference for all analog inputs.
–IN6	25	1	Analog Input	Ground-referred inverting op amp input. Refer to Section 4.0, “ANALOG INPUTS”.
FB6	26	1	Analog Output	Output of inverting op amp for Input 6. Refer to section 4.0, “ANALOG INPUTS”.
FB5	27	1	Analog Output	Output of inverting op amp for Input 5. Refer to section 4.0, “ANALOG INPUTS”.
–IN5	28	1	Analog Input	Ground-referred inverting op amp input. Refer to Section 4.0, “ANALOG INPUTS”.
IN4–IN0	29–33	5	Analog Input	0V to 4.096V FSR Analog Inputs.
VID3–VID0	34–37	4	Digital Input	Voltage Supply readouts from P6. This value is read in the VID/Fan Divisor Register.
$\overline{\text{BTI}}$	38	1	Digital Input	Board Temperature Interrupt driven by O.S. outputs of additional temperature sensors such as LM75. Provides internal pull-up of 10 k $\Omega$ .
$\overline{\text{NMI/IRQ}}$	39	1	Digital Output	Non-Maskable Interrupt (open source)/Interrupt Request (open drain). The mode is selected with Bit 5 of the Configuration Register and the output is enabled when Bit 2 of the Configuration Register is set to 1. The default state is disabled and $\overline{\text{IRQ}}$ mode.
$\overline{\text{SMI}}$	40	1	Digital Output	System Management Interrupt (open drain). This output is enabled when Bit 1 in the Configuration Register is set to 1. The default state is disabled.

## Pin Descriptions (Continued)

Pin Name(s)	Pin Number	Number of Pins	Type	Description
A2–A0	41–43	3	Digital Input	The three lowest order bits of the 16-bit ISA Address Bus. A0 corresponds to the lowest order bit.
$\overline{\text{CS}}$	44	1	Digital Input	Chip Select input from an external decoder which decodes high order address bits on the ISA Address Bus. This is an active low input.
<b>TOTAL PINS</b>		<b>44</b>		

EEPW 电子产品世界  
www.eepw.com.cn

**Absolute Maximum Ratings** (Notes 1, 2)

If Military/Aerospace specified devices are required, please contact the National Semiconductor Sales Office/Distributors for availability and specifications.

Positive Supply Voltage ( $V_{CC}$ )	6.5V
Voltage on Any Input or Output Pin	-0.3V to ( $V_{CC}+0.3V$ )
Ground Difference (GNDD–GNDA)	±300 mV
Input Current at any Pin (Note 3)	±5 mA
Package Input Current (Note 3)	±20 mA
Maximum Junction Temperature ( $T_J$ max)	150°C
ESD Susceptibility(Notes 5)	
Human Body Model	2000V
Machine Model	175V
Soldering Information	
PQFP Package (Note 6) :	

Vapor Phase (60 seconds)	215°C
Infrared (15 seconds)	220°C
Storage Temperature	-65°C to +150°C

**Operating Ratings**(Notes 1, 2)

Operating Temperature Range	$T_{MIN} \leq T_A \leq T_{MAX}$
LM78	-55°C ≤ $T_A$ ≤ +125°C
Specified Temperature Range	$T_{MIN} \leq T_A \leq T_{MAX}$
LM78	-10°C ≤ $T_A$ ≤ +100°C
Junction to Ambient Thermal Resistance ( $\theta_{JA}$ (Note 4) )	
NS Package ID: VGZ44A	62°C/W
Supply Voltage ( $V_{CC}$ )	+4.25V to +5.75V
Ground Difference (IGNDD–GNDAI)	≤100 mV
$V_{IN}$ Voltage Range	-0.05V to $V_{CC} + 0.05V$

**DC Electrical Characteristics**(Note 7)

The following specifications apply for +4.25  $V_{DC} \leq V_{CC} \leq +5.75 V_{DC}$ ,  $f_{SYSCLK} = 8.33$  MHz,  $R_S = 25\Omega$ , unless otherwise specified. **Boldface limits apply for  $T_A = T_J = T_{MIN}$  to  $T_{MAX}$** ; all other limits  $T_A = T_J = 25^\circ\text{C}$ .

Symbol	Parameter	Conditions	Typical (Note 8)	Limits (Note 9)	Units (Limits)
<b>POWER SUPPLY CHARACTERISTICS</b>					
$I_{CC}$	Supply Current	Interface Inactive	1.0	<b>2</b>	mA (max)
		Shutdown Mode	10		μA
<b>TEMPERATURE-TO-DIGITAL CONVERTER CHARACTERISTICS</b>					
	Accuracy	-10°C ≤ $T_A$ ≤ +100°C		<b>±3</b>	°C (max)
	Resolution			<b>1</b>	°C (min)
<b>ANALOG-TO-DIGITAL CONVERTER CHARACTERISTICS</b>					
	Resolution (8 bits with full-scale at 4.096V)		16		mV
TUE	Total Unadjusted Error	(Note 10)		<b>±1</b>	% (max)
DNL	Differential Non-Linearity			<b>±1</b>	LSB
PSS	Power Supply Sensitivity		±1		%/V
$t_C$	Total Monitoring Cycle Time	(Note 11)	1.0	<b>1.5</b>	sec (max)
<b>OP AMP CHARACTERISTICS</b>					
	Output Current (Sourcing)		50		μA
	Input Offset Voltage	$I_{OUT} = 50 \mu\text{A}$	±1		mV
	Input Bias Current		±0.1		nA
	PSRR		60		dB
	DC Open Loop Gain		70		dB
	Gain Bandwidth Product		500		kHz
<b>MULTIPLEXER/ADC INPUT CHARACTERISTICS</b>					
	On Resistance		400	<b>2000</b>	Ω (max)
	Off Channel Leakage Current		±0.1		nA
	Input Current (On Channel Leakage Current)		±0.1		nA
<b>FAN RPM-TO-DIGITAL CONVERTER</b>					
	Accuracy	+25°C ≤ $T_A$ ≤ +75°C		<b>±10</b>	% (max)
		-10°C ≤ $T_A$ ≤ +100°C		<b>±15</b>	% (max)
	Full-scale Count			<b>255</b>	(max)

## DC Electrical Characteristics (Note 7) (Continued)

The following specifications apply for  $+4.25 V_{DC} \leq V_{CC} \leq +5.75 V_{DC}$ ,  $f_{SYSCLK} = 8.33 \text{ MHz}$ ,  $R_S = 25\Omega$ , unless otherwise specified. **Boldface limits apply for  $T_A = T_J = T_{MIN}$  to  $T_{MAX}$** ; all other limits  $T_A = T_J = 25^\circ\text{C}$ .

Symbol	Parameter	Conditions	Typical (Note 8)	Limits (Note 9)	Units (Limits)
<b>FAN RPM-TO-DIGITAL CONVERTER</b>					
	FAN1 and FAN2 Nominal Input RPM (See Section 6.0)	Divisor = 1, Fan Count = 153 (Note 12)	8800		RPM
		Divisor = 2, Fan Count = 153 (Note 12)	4400		RPM
		Divisor = 3, Fan Count = 153 (Note 12)	2200		RPM
		Divisor = 4, Fan Count = 153 (Note 12)	1100		RPM
	FAN3 Design Nominal Input RPM	Fan Count = 153 (Note 12)	4400		RPM
	Internal Clock Frequency	$+25^\circ\text{C} \leq T_A \leq +75^\circ\text{C}$	22.5	<b>20.2</b> <b>24.8</b>	kHz (min) kHz (max)
		$-10^\circ\text{C} \leq T_A \leq +100^\circ\text{C}$	22.5	<b>19.1</b> <b>25.9</b>	kHz (min) kHz (max)
<b>DIGITAL OUTPUTS (Power Switch Bypass, NTEST, NMI/IRQ)</b>					
$V_{OUT(1)}$	Logical "1" Output Voltage	$I_{OUT} = \pm 5.0 \text{ mA}$		<b>2.4</b>	V (min)
$V_{OUT(0)}$	Logical "0" Output Voltage	$I_{OUT} = \pm 5.0 \text{ mA}$		<b>0.4</b>	V (max)
<b>ISA D0–D7 DIGITAL OUTPUTS</b>					
$V_{OUT(1)}$	Logical "1" Output Voltage	$I_{OUT} = \pm 12.0 \text{ mA}$		<b>2.4</b>	V (min)
$V_{OUT(0)}$	Logical "0" Output Voltage	$I_{OUT} = \pm 12.0 \text{ mA}$		<b>0.4</b>	V (max)
$I_{OUT}$	TRI-STATE® Output Current	$V_{OUT} = 0 V_{DC}$ $V_{OUT} = V_{CC}$	0.005 –0.005	<b>1</b> <b>–1</b>	$\mu\text{A}$ (max) $\mu\text{A}$ (min)
<b>OPEN DRAIN DIGITAL OUTPUTS (SDA, RESET, SMI, Chassis Intrusion)</b>					
$V_{OUT(0)}$	Logical "0" Output Voltage	$I_{OUT} = -5.0 \text{ mA}$		<b>0.4</b>	V (min)
$I_{OH}$	High Level Output Current	$V_{OUT} = V_{CC}$	0.1	<b>100</b>	$\mu\text{A}$ (max)
	RESET and Chassis Intrusion Pulse Width		45	<b>20</b>	ms (min)
<b>DIGITAL INPUTS: SMI_IN, VID0–VID3, BTI, CS, A0, A1, A2, Mode Control and Interface Inputs (IORD, IOWR, SYSCLK), Data Lines (D0–D7), Chassis Intrusion, and Tach Pulse Logic Inputs (FAN1, FAN2, FAN3)</b>					
$V_{IN(1)}$	Logical "1" Input Voltage			<b>2.0</b>	V (min)
$V_{IN(0)}$	Logical "0" Input Voltage			<b>0.8</b>	V (max)
<b>SERIAL BUS DIGITAL INPUTS (SCL, SDA)</b>					
$V_{IN(1)}$	Logical "1" Input Voltage			<b><math>0.7 \times V_{CC}</math></b>	V (min)
$V_{IN(0)}$	Logical "0" Input Voltage			<b><math>0.3 \times V_{CC}</math></b>	V (max)
<b>ALL DIGITAL INPUTS EXCEPT FOR BTI</b>					
$I_{IN(1)}$	Logical "1" Input Current	$V_{IN} = V_{CC}$	–0.005	<b>–1</b>	$\mu\text{A}$ (min)
$I_{IN(0)}$	Logical "0" Input Current	$V_{IN} = 0 V_{DC}$	0.005	<b>1</b>	$\mu\text{A}$ (max)
$C_{IN}$	Digital Input Capacitance		20		pF
<b>BIT DIGITAL INPUT</b>					
$I_{IN(1)}$	Logical "1" Input Current	$V_{IN} = V_{CC}$	1	<b>10</b>	$\mu\text{A}$ (max)
$I_{IN(0)}$	Logical "0" Input Current	$V_{IN} = 0 V_{DC}$	–500	<b>–2000</b>	$\mu\text{A}$ (max)
$C_{IN}$	Digital Input Capacitance		20		pF

**AC Electrical Characteristics** (Note 13) The following specifications apply for  $+4.25 V_{DC} \leq V_{CC} \leq +5.75 V_{DC}$  unless otherwise specified. **Boldface limits apply for  $T_A = T_J = T_{MIN}$  to  $T_{MAX}$** ; all other limits  $T_A = T_J = 25^\circ\text{C}$ .

Symbol	Parameter	Conditions	Typical (Note 8)	Limits (Note 9)	Units (Limits)
<b>ISA TIMING CHARACTERISTICS</b>					
$f_{\text{SYSCLK}}$	System Clock (SYSCLK) Input Frequency		8.33		MHz
$t_{\text{CS}}(\text{setup})$	$\overline{\text{CS}}$ Active to $\overline{\text{IORD}}/\overline{\text{IOWR}}$ Active			<b>10</b>	ns (min)
$t_{\text{CS}}(\text{hold})$	$\overline{\text{IORD}}/\overline{\text{IOWR}}$ Inactive to $\overline{\text{CS}}$ Inactive			<b>10</b>	ns (min)
$t_{\text{SA}}(\text{setup})$	Address Valid to $\overline{\text{IORD}}/\overline{\text{IOWR}}$ Active			<b>30</b>	ns (min)
$t_{\text{SA}}(\text{hold})$	$\overline{\text{IORD}}/\overline{\text{IOWR}}$ Inactive to Address Invalid			<b>10</b>	ns (min)
<b>ISA WRITE TIMING</b>					
$t_{\text{SDWR}}(\text{setup})$	Data Valid to $\overline{\text{IOWR}}$ Active			<b>5</b>	ns (min)
$t_{\text{SDWR}}(\text{hold})$	$\overline{\text{IOWR}}$ Inactive to Data Invalid			<b>5</b>	ns (min)
$t_{\text{WR}}(\text{setup})$	$\overline{\text{IOWR}}$ Active to Rising Edge of SYSCLK			<b>20</b>	ns (min)

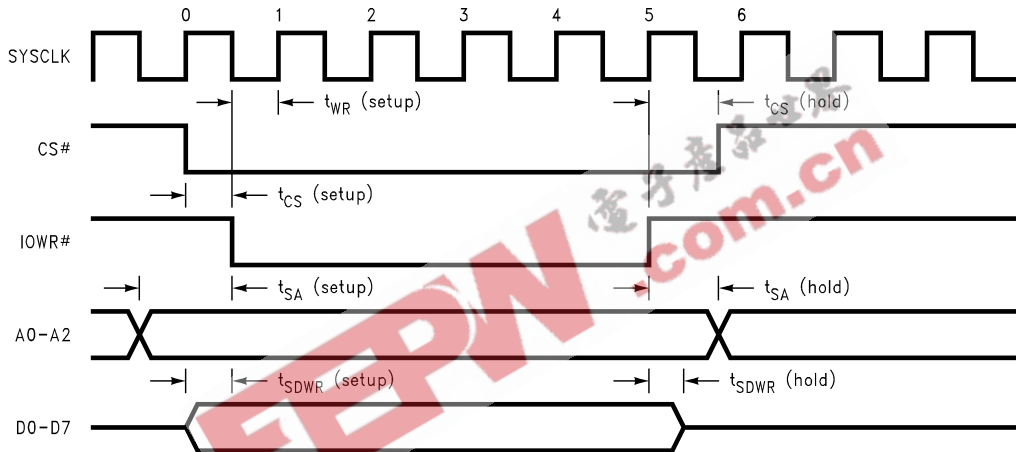

DS012873-4

The delay between consecutive  $\overline{\text{IORD}}$  and  $\overline{\text{IOWR}}$  pulses should be greater than 50 ns to ensure that an Power-on reset does not occur unintentionally. (See **Section 3.2** 'Resets')

**FIGURE 1. ISA Bus Write Timing Diagram**

**AC Electrical Characteristics** (Note 13) The following specifications apply for  $+4.25 V_{DC} \leq V_{CC} \leq +5.75 V_{DC}$  unless otherwise specified. **Boldface limits apply for  $T_A = T_J = T_{MIN}$  to  $T_{MAX}$** ; all other limits  $T_A = T_J = 25^\circ C$ . (Continued)

Symbol	Parameter	Conditions	Typical (Note 8)	Limits (Note 9)	Units (Limits)
<b>ISA READ TIMING</b>					
$t_{SDRD}$ (setup)	Data Valid to $\overline{IORD}$ Inactive			<b>120</b>	ns (min)
$t_{SDRD}$ (hold)	$\overline{IORD}$ Inactive to Data Invalid			<b>5</b>	ns (min)
$t_{RD}$ (setup)	$\overline{IORD}$ Active to Rising Edge of SYSCLK			<b>20</b>	ns (min)
$t_{RS}$ (delay)	Rising Edge of SYSCLK number 1 to Data Valid	With 8.33 MHz SYSCLK		<b>360</b>	ns (max)

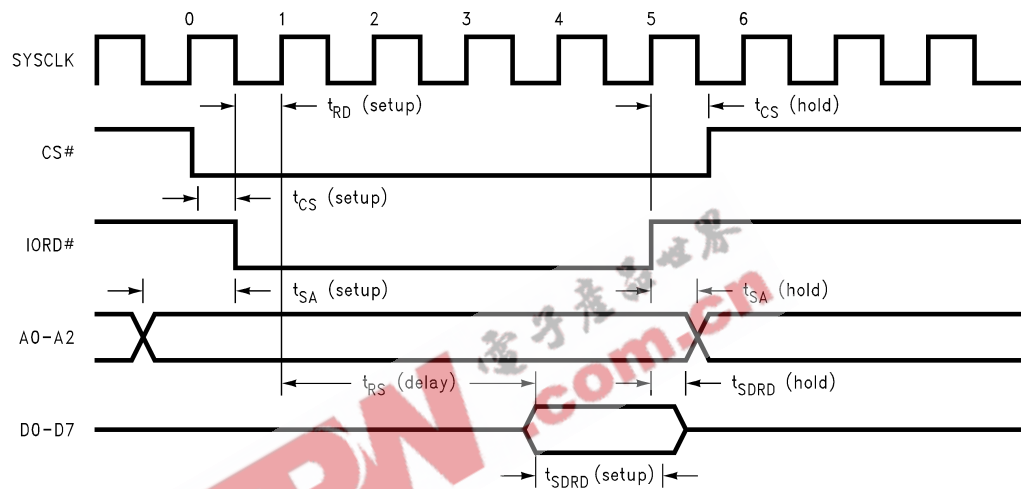

DS012873-5

The delay between consecutive  $\overline{IORD}$  and  $\overline{IOWR}$  pulses should be greater than 50 ns to ensure that an Power-on reset does not occur unintentionally. (See Section 3.2 'Resets' )

**FIGURE 2. ISA Bus Read Timing Diagram**



**AC Electrical Characteristics** (Note 13) The following specifications apply for  $+4.25 V_{DC} \leq V_{CC} \leq +5.75 V_{DC}$  unless otherwise specified. **Boldface limits apply for  $T_A = T_J = T_{MIN}$  to  $T_{MAX}$** ; all other limits  $T_A = T_J = 25^\circ C$ . (Continued)

Symbol	Parameter	Conditions	Typical (Note 8)	Limits (Note 9)	Units (Limits)
<b>SERIAL BUS TIMING CHARACTERISTICS</b>					
$t_1$	SCL (Clock) Period			<b>2.5</b>	$\mu s$ (min)
$t_2$	Data In Setup Time to SCL High			<b>100</b>	ns (min)
$t_3$	Data Out Stable After SCL Low			<b>0</b>	ns (min)
$t_4$	SDA Low Setup Time to SCL Low (start)			<b>100</b>	ns (min)
$t_5$	SDA High Hold Time After SCL High (stop)			<b>100</b>	ns (min)

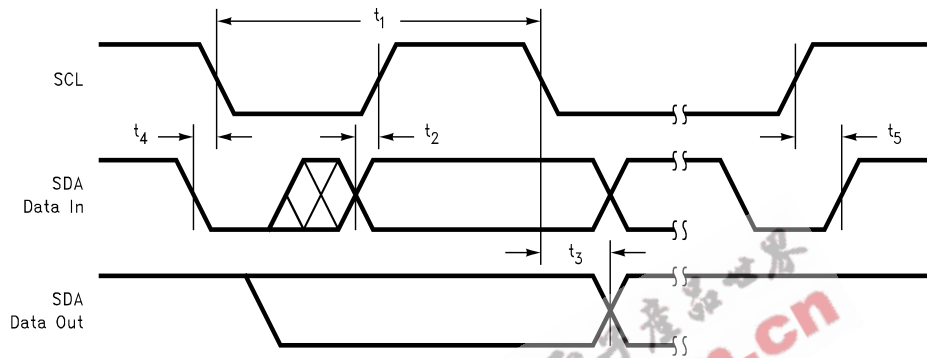

FIGURE 3. Serial Bus Timing Diagram

### Electrical Characteristics (Continued)

**Note 1:** Absolute Maximum Ratings indicate limits beyond which damage to the device may occur. Operating Ratings indicate conditions for which the device is functional, but do not guarantee specific performance limits. For guaranteed specifications and test conditions, see the Electrical Characteristics. The guaranteed specifications apply only for the test conditions listed. Some performance characteristics may degrade when the device is not operated under the listed test conditions.

**Note 2:** All voltages are measured with respect to GND, unless otherwise specified

**Note 3:** When the input voltage ( $V_{IN}$ ) at any pin exceeds the power supplies ( $V_{IN} < (GNDD \text{ or } GNDA)$  or  $V_{IN} > V_{CC}$ ), the current at that pin should be limited to 5 mA. The 20 mA maximum package input current rating limits the number of pins that can safely exceed the power supplies with an input current of 5 mA to four.

**Note 4:** The maximum power dissipation must be derated at elevated temperatures and is dictated by  $T_{Jmax}$ ,  $\theta_{JA}$  and the ambient temperature,  $T_A$ . The maximum allowable power dissipation at any temperature is  $P_D = (T_{Jmax} - T_A) / \theta_{JA}$ .

**Note 5:** The human body model is a 100 pF capacitor discharged through a 1.5 k $\Omega$  resistor into each pin. The machine model is a 200 pF capacitor discharged directly into each pin.

**Note 6:** See the section titled "Surface Mount" found in any post 1986 National Semiconductor Linear Data Book for other methods of soldering surface mount devices.

**Note 7:** Each input and output is protected by a nominal 6.5V breakdown voltage zener diode to GND; as shown below, input voltage magnitude up to 0.3V above  $V_{CC}$  or 0.3V below GND will not damage the LM78. There are parasitic diodes that exist between the inputs and the power supply rails. Errors in the ADC conversion can occur if these diodes are forward biased by more than 50 mV. As an example, if  $V_{CC}$  is 4.50  $V_{DC}$ , input voltage must be  $\leq 4.55 V_{DC}$ , to ensure accurate conversions.

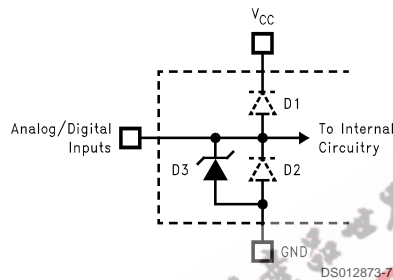

An x indicates that the diode exists.

Pin Name	D1	D2	D3
IORD			x
IOWR			x
SYSCLK			x
D0–D7	x	x	x
SMI_IN			x
Chassis Intrusion		x	x
Power Switch Bypass	x	x	x

Pin Name	D1	D2	D3
FAN1–FAN3			x
SCL			x
SDA		x	x
RESET		x	x
NTEST	x	x	x

Pin Name	D1	D2	D3
–IN6		x	x
FB6	x	x	x
FB5	x	x	x
–IN5		x	x
IN4–IN0	x	x	x
VID3–VID0	x	x	x

Pin Name	D1	D2	D3
BTI	x		x
NMI/IRQ	x	x	x
SMI		x	x
A0–A2			x
CS			x

FIGURE 4. ESD Protection Input Structure

**Note 8:** Typicals are at  $T_J = T_A = 25^\circ\text{C}$  and represent most likely parametric norm.

**Note 9:** Limits are guaranteed to National's AOQL (Average Outgoing Quality Level).

**Note 10:** TUE (Total Unadjusted Error) includes Offset, Gain and Linearity errors of the ADC and any error introduced by the amplifiers as shown in the circuit of Figure 13.

**Note 11:** Total Monitoring Cycle Time includes temperature conversion, 7 analog input voltage conversions and 3 tachometer readings. Each temperature and input voltage conversion takes 100 ms typical and 112 ms maximum. Fan tachometer readings take 20 ms typical, at 4400 rpm, and 200 ms max.

**Note 12:** The total fan count is based on 2 pulses per revolution of the fan tachometer output.

**Note 13:** Timing specifications are tested at the TTL logic levels,  $V_{IL} = 0.4\text{V}$  for a falling edge and  $V_{IH} = 2.4\text{V}$  for a rising edge. TRI-STATE output voltage is forced to 1.4V.

## Test Circuit

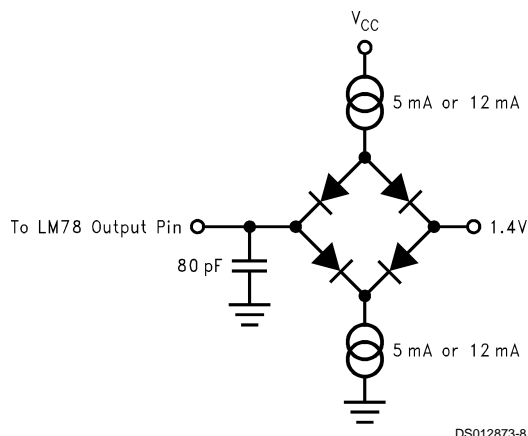

FIGURE 5. Digital Output Load Circuitry

## Functional Description

### 1.0 GENERAL DESCRIPTION

The LM78 provides 7 analog inputs, a temperature sensor, a Delta-Sigma ADC (Analog-to-Digital Converter), 3 fan speed counters, WATCHDOG registers, and a variety of inputs and outputs on a single chip. Interfaces are provided for both the ISA parallel bus or Serial Bus. The LM78 performs power supply, temperature, and fan monitoring for personal computers.

The LM78 continuously converts analog inputs to 8-bit digital words with a 16 mV LSB (Least Significant Bit) weighting, yielding input ranges of from 0V to 4.096V. The two negative analog inputs provide inverting op amps, with their non-inverting input referred to ground. With additional external feedback components, these inputs provide measurements of negative voltages (such as -5V and -12V power supplies). The analog inputs are useful for monitoring several power supplies present in a typical computer. Temperature is converted to an 8-bit two's-complement digital word with a 1°C LSB.

Fan inputs measure the period of tachometer pulses from the fans, providing a higher count for lower fan speeds. The fan inputs are digital inputs with an acceptable range of 0V to 5V and a transition level of approximately 1.4V. Full scale fan counts are 255 (8-bit counter) and this represents a stopped or very slow fan. Nominal speeds, based on a count of 153, are programmable from 1100 to 8800 RPM on FAN1 and FAN2, with FAN3 fixed at 4400 RPM. Signal conditioning circuitry is included to accommodate slow rise and fall times.

The LM78 provides a number of internal registers, as detailed in Figure 6. These include:

- **Configuration Register:** Provides control and configuration.
- **Interrupt Status Registers:** Two registers to provide status of each WATCHDOG limit or Interrupt event.
- **Interrupt Mask Registers:** Allows masking of individual Interrupt sources, as well as separate masking for each of both hardware Interrupt outputs.
- **VID/Fan Divisor Registers:** A register to read the status of the VID input lines. The high bits of this register contain the divisor bits for FAN1 and FAN2 inputs.

- **Serial Bus Address Register:** Contains the Serial Bus address. At power on it assumes the default value of 0101101 binary, and can be altered via the ISA or Serial Bus interface.
- **Chip Reset/ID Register:** Allows resetting of all the registers to the default power-on reset value. Provides a bit for identification between the current version of this device and an older version which does not have this reset capability.
- **POST RAM:** FIFO RAM to store up to 32 bytes of 8-bit POST codes. Overflow of the POST RAM will set an Interrupt. The POST RAM, located at base address x0h and x4h, allows for easy decoding to address 80h and 84h, the normal addresses for outputting of POST codes. Interrupt will only be set when writing to port x0h or x4h. The POST RAM can be read via ports 85h and 86h.
- **Value RAM:** The monitoring results: temperature, voltages, fan counts, and WATCHDOG limits are all contained in the Value RAM. The Value RAM consists of a total of 64 bytes. The first 11 bytes are all of the results, the next 19 bytes are the WATCHDOG limits, and are located at 20h-3Fh, including two unused bytes in the upper locations. The next 32 bytes, located at 60h-7Fh, mirror the first 32 bytes with identical contents. The only difference in the upper bytes are that they auto-increment the LM78 Internal Address Register when read from or written to via the ISA bus (auto-increment is not available for Serial Bus communications).

When the LM78 is started, it cycles through each measurement in sequence, and it continuously loops through the sequence approximately once every second. Each measured value is compared to values stored in WATCHDOG, or Limit registers. When the measured value violates the programmed limit the LM78 will set a corresponding Interrupt in the Interrupt Status Registers. Two hardware Interrupt lines,  $\overline{\text{SMI}}$  and  $\text{NMI}/\text{IRQ}$ , are fully programmable with separate masking of each Interrupt source, and masking of each output. In addition, the Configuration Register has control bits to enable or disable the hardware Interrupts.

Additional digital inputs are provided for chaining of  $\overline{\text{SMI}}$  (System Management Interrupt), outputs of multiple external LM75 temperature sensors via the  $\overline{\text{BTI}}$  (Board Temperature Interrupt) input, and a Chassis Intrusion input. The Chassis Intrusion input is designed to accept an active high signal from an external circuit that latches when the case is removed from the computer.

## Functional Description (Continued)

### 2.0 INTERFACE

The LM78 only decodes the three lowest address bits on the ISA bus. Referring to the ISA bus timing diagrams in *Figure 1* and *Figure 2*, the Chip Select Input,  $\overline{CS}$ , should be taken low by external address decoder circuitry to access the LM78. The LM78 decodes the following base addresses:

- Port x0h: Power On Self Test codes from ISA bus.
- Port x4h: Power On Self Test codes from ISA bus.
- Port x5h: The LM78s Internal Address Register
- Port x6h: Data Register

$\overline{IORD}$  is the standard ISA bus signal that indicates to the LM78 that it may drive data on to the ISA data bus.

$\overline{IOWR}$  is the standard ISA command to the LM78 that it may latch data from the ISA bus.

SYSCLK is the standard ISA SYSCLK, typically 8.33 MHz. This clock is used only for timing of the ISA interface of the LM78. All other clock functions within LM78 such as the ADC and fan counters are done with a separate asynchronous internal clock.

A typical application designed to utilize the POST RAM would decode the LM78 to the address space starting at 80h, which is where POST codes are output to. Otherwise, the LM78 can be decoded into a different desired address space.

To communicate with an LM78 Register, first write the address of that Register to Port x5h. Read or write data from or to that register via Port x6h. A write will take  $\overline{IOWR}$  low, while a read will take  $\overline{IORD}$  low.

If the Serial Bus Interface and ISA bus interface are used simultaneously there is the possibility of collision. To prevent this from occurring in applications where both interfaces are used, read port x5h and if the Most Significant Bit, D7, is high, ISA communication is limited to reading port x5h only until this bit is low. A Serial Bus communication occurring while ISA is active will not be a problem, since even a single bit of Serial Bus communication requires 10 microseconds, in comparison to less than a microsecond for an entire ISA communication.

EEPW.com.cn 电子产品世界

Functional Description (Continued)

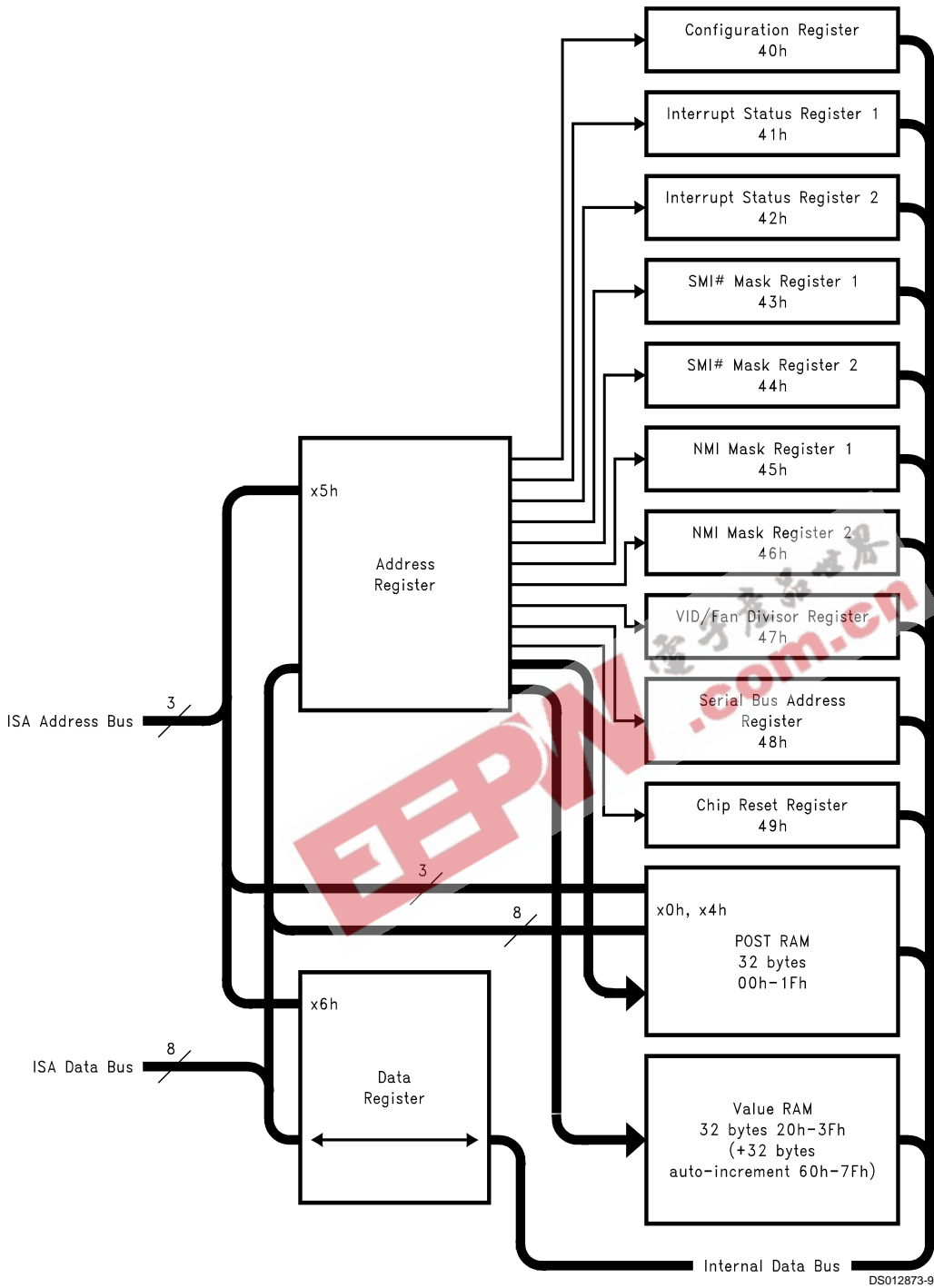

FIGURE 6. LM78 Register Structure

DS012873-9

## Functional Description (Continued)

### 2.1 Internal Registers of the LM78

TABLE 1. The internal registers and their corresponding internal LM78 address is as follows:

Register	LM78 Internal Hex Address (This is the data to be written to Port x5h)	Power on Value	Notes
Configuration Register	40h	0000 1000	
Interrupt Status Register 1	41h	0000 0000	Auto-increment to the address of Interrupt Status Register 2 after a read or write to Port x6h.
Interrupt Status Register 2	42h	0000 0000	
$\overline{\text{SMI}}$ Mask Register 1	43h	0000 0000	Auto-increment to the address of $\overline{\text{SMI}}$ Mask Register 2 after a read or write to Port x6h.
$\overline{\text{SMI}}$ Mask Register 2	44h	0000 0000	
NMI Mask Register 1	45h	0000 0000	Auto-increment to the address of NMI Mask Register 2 after a read or write to Port x6h.
NMI Mask Register 2	46h	0100 0000	
VID/Fan Divisor Register	47h	0101 XXXX	The first four bits set the divisor for Fan Counters 1 and 2. The lower four bits reflect the state of the VID inputs.
Serial Bus Address Register	48h	0010 1101	
Chip Reset/ID Register	49h	0100 0000	
POST RAM	00h-1Fh		Auto-increment when written to from Port x0h or x4h. Auto-increment after a read or write to Port x6h, with a separate pointer. Auto-incrementing stops when address 1Fh is reached.
Value RAM	20h-3Fh		
Value RAM	60h-7Fh		Auto-increment after a read or write to Port x6h. Auto-incrementing stops when address 7Fh is reached.

A typical communication with the LM78 would consist of:

1. Write to Port x5h the LM78 Internal Address (from column 2 above) of the desired register. Alternatively, when both ISA and Serial Bus interfaces are used, the first step in a communication may be to read Port x5h to ascertain the state of the Busy bit to avoid contention with an Serial Bus communication.
2. Read or write the corresponding registers data with reads/writes from Port x6h.

The LM78 Internal Address latches, and does not have to be written if it is already pointing at the desired register. The LM78 Internal Address Register is read/write (Bit 7 is read only).

## Functional Description (Continued)

### 2.2 Serial Bus Interface

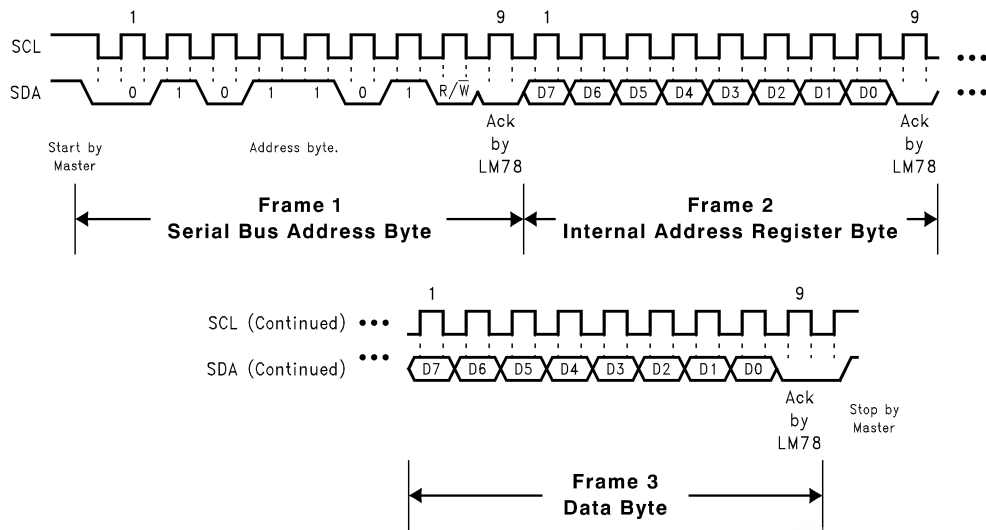

(a) Serial Bus Write to the Internal Address Register followed by the Data Byte

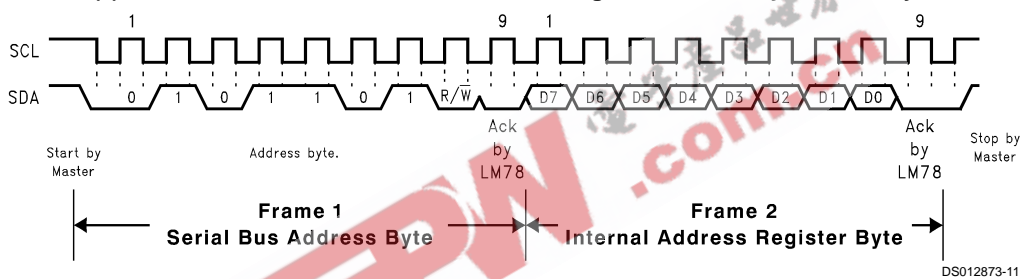

(b) Serial Bus Write to the Internal Address Register Only

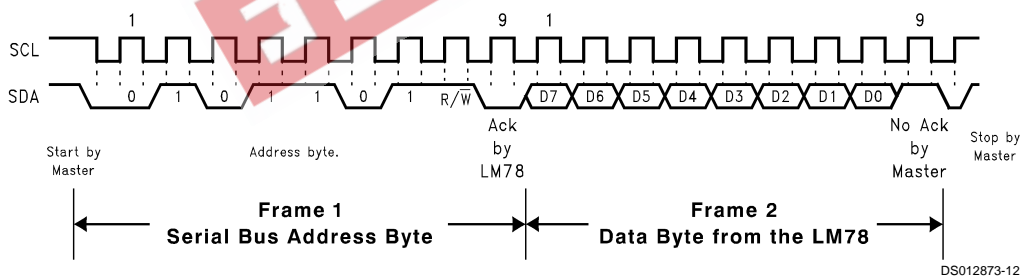

(c) Serial Bus Read from a Register with the Internal Address Register Preset to Desired Location

FIGURE 7. Serial Bus Timing

When using the Serial Bus Interface a write will always consist of the LM78 Serial Bus Interface Address byte, followed by the Internal Address Register byte, then the data byte. There are two cases for a read:

1. If the Internal Address Register is known to be at the desired Address, simply read the LM78 with the Serial Bus Interface Address byte, followed by the data byte read from the LM78.
2. If the Internal Address Register value is unknown, write to the LM78 with the Serial Bus Interface Address byte, followed by the Internal Address Register byte. Then restart the Serial Communication with a Read consisting of the Serial Bus Interface Address byte, followed by the data byte read from the LM78.

In all other respects the LM78 functions identically for Serial Bus communications as it does for ISA communications.

Auto-Increment does not operate. When writing to or reading from a Register which Auto-Increments with ISA communications, the Register must be manually incremented for Serial Bus communications.

The default power on Serial Bus address for the LM78 is: 0101101 binary. This address can be changed by writing any desired value to the Serial Bus address register, which can be done either via the ISA or Serial Bus. During and Serial Bus communication on the BUSY bit (bit 7) in the address register at x5h will be high, and any ISA activity in that situation should be limited to reading port x5h only.

All of these communications are depicted in the Serial Bus Interface Timing Diagrams as shown in Figure 7.

## Functional Description (Continued)

### 3.0 USING THE LM78

#### 3.1 Power On

When power is first applied, the LM78 performs a “power on reset” on several of its registers. The power on condition of registers is shown in Table I. Registers whose power on values are not shown have power on conditions that are indeterminate (this includes the value RAM and WATCHDOG limits). The ADC is inactive. In most applications, usually the first action after power on would be to write WATCHDOG limits into the Value RAM.

#### 3.2 Resets

Configuration Register INITIALIZATION accomplishes the same function as power on reset on most registers. The POST RAM, Value RAM conversion results, and Value RAM WATCHDOG limits are not Reset and will be indeterminate immediately after power on. If the Value RAM contains valid conversion results and/or Value RAM WATCHDOG limits have been previously set, they will not be affected by a Configuration Register INITIALIZATION. Power on reset, or Configuration Register INITIALIZATION, clear or initialize the following registers (the initialized values are shown on Table I):

- Configuration Register
- Interrupt Status Register 1
- Interrupt Status Register 2
- $\overline{\text{SMI}}$  Mask Register 1
- $\overline{\text{SMI}}$  Mask Register 2
- NMI Mask Register 1
- NMI Mask Register 2
- VID/Fan Divisor Register
- Serial Bus Address Register (Power on reset only, not reset by Configuration Register INITIALIZATION)

Configuration Register INITIALIZATION is accomplished by setting Bit 7 of the Configuration Register high. This bit automatically clears after being set.

The LM78-J allows the user to perform an unconditional complete Power-on reset by writing a one to Bit 5 of the Chip Reset/ID Register. The LM78-J can be differentiated from the LM78 without the J suffix by reading Chip Reset/ID Register Bit 6. A high would indicate that the LM78-J is being used. The LM78-J allows an unconditional complete Power-on reset to be initiated by taking the  $\overline{\text{IOWR}}$  and  $\overline{\text{IORD}}$  signal lines low simultaneously, for at least 50 ns, while  $\overline{\text{CS}}$  is high. The delay between consecutive  $\overline{\text{IORD}}$  and  $\overline{\text{IOWR}}$  pulses should be greater than 50 ns to ensure that an Power-on reset does not occur unintentionally.

In systems where the serial bus is only being used it may be advantageous to take both  $\overline{\text{IOWR}}$  and  $\overline{\text{IORD}}$  to the system reset pulse. In this way whenever the system is reset the LM78-J will also be reset to a known state.

#### 3.3 Using the Configuration Register

The Configuration Register provides all control over the LM78. At power on, the ADC is stopped and INT\_\_Clear is asserted, clearing the  $\overline{\text{SMI}}$  and  $\overline{\text{NMI/IRQ}}$  hardware outputs. The Configuration Register starts and stops the LM78, enables and disables interrupt outputs and modes, and provides the Reset function described in Section 3.2.

Bit 0 of the Configuration Register controls the monitoring loop of the LM78. Setting Bit 0 low stops the LM78 monitor-

ing loop and puts the LM78 in shutdown mode, reducing power consumption. ISA and Serial Bus communication is possible with any register in the LM78 although activity on these lines will increase shutdown current, up to as much as maximum rated supply current, while the activity takes place. Taking Bit 0 high starts the monitoring loop, described in more detail subsequently.

Bit 1 of the Configuration Register enables the  $\overline{\text{SMI}}$  Interrupt hardware output when this bit is taken high. Similarly, Bit 2 of the Configuration Register enables the  $\overline{\text{NMI/IRQ}}$  Interrupt hardware output when taken high. The  $\overline{\text{NMI/IRQ}}$  mode is determined by Bit 5 in the Configuration Register. When Bit 5 is low the output is an active low  $\overline{\text{IRQ}}$  output. Taking Bit 5 high inverts this output to provide an active high NMI output.

The Power Switch Bypass provides an active low at the Power Switch Bypass output when set high. This is intended for use in software power control by activating an external power control MOSFET.

#### 3.4 Starting Conversion

The monitoring function (Analog inputs, temperature, and fan speeds) in the LM78 is started by writing to the Configuration Register and setting INT\_\_Clear (Bit 3), low, and Start (bit 0), high. The LM78 then performs a “round-robin” monitoring of all analog inputs, temperature, and fan speed inputs approximately once a second. The sequence of items being monitored corresponds to locations in the Value RAM and is:

1. Temperature
2. IN0
3. IN1
4. IN2
5. IN3
6. IN4
7. -IN5
8. -IN6
9. Fan 1
10. Fan 2
11. Fan 3

#### 3.5 Reading Conversion Results

The conversion results are available in the Value RAM. Conversions can be read at any time and will provide the result of the last conversion. Because the ADC stops, and starts a new conversion whenever it is read, reads of any single value should not be done more often than once every 120 ms. When reading all values, allow at least 1.5 seconds between reading groups of values. Reading more frequently than once every 1.5 seconds can also prevent complete updates of Interrupt Status Registers and Interrupt Output's.

A typical sequence of events upon power on of the LM78 would consist of:

1. Set WATCHDOG Limits
2. Set Interrupt Masks
3. Start the LM78 monitoring process

#### 4.0 ANALOG INPUTS

The 8-bit ADC has a 16 mV LSB, yielding a 0V to 4.08V (4.096–1LSB) input range. This is true for all analog inputs. In PC monitoring applications these inputs would most often be connected to power supplies. The 2.5V and 3.3V supplies can be directly connected to the inputs. The 5V and 12V inputs should be attenuated with external resistors to any desired value within the input range.



## Functional Description (Continued)

A typical application, such as is shown in *Figure 8*, might select the input voltage divider to provide 3V at the analog inputs of the LM78. This is sufficiently high for good resolution of the voltage, yet leaves headroom for upward excursions from the supply of about 25%. To simplify the process of resistor selection, set the value of R2 first. Select a value for R2 between 10 kΩ and 100 kΩ. This is low enough to avoid errors due to input leakage currents yet high enough to both protect the inputs under overdrive conditions as well as minimize loading of the source. Then select R1 to provide a 3V input according to:

$$R1 = R2 \left( \frac{V_S}{V_{IN}} - 1 \right)$$

The negative inputs provide inverting op amps with non-inverting inputs connected to ground. The output of these op amps are designed to only drive the input of the LM78 and their associated feedback loops. Avoid heavy loading, long lines, and capacitive loading with these op amps. Additional loading may cause oscillations and thus erroneous readings. The optimum feedback resistor (resistor from Feedback to -IN pin) value is approximately 60 kΩ, based on the op amp nominal output current rating of 50 μA at an output voltage of 3V. Locate the feedback resistors as close as possible to the LM78. The recommended range for R<sub>IN</sub> is from 30 kΩ to 300 kΩ.

Select R<sub>IN</sub> according to:

$$R_{IN} = \frac{V_S \times R_F}{V_{FEEDBACK}}$$

The analog inputs have internal diodes that clamp inputs exceeding the power supply and ground. Exceeding any analog input has no detrimental effect on other channels. The input diodes will also clamp voltages appearing at the inputs of an un-powered LM78. External resistors should be included to limit input currents to the values given in the ABSOLUTE MAXIMUM RATINGS for Input Current At Any Pin. Inputs with the attenuator networks will usually meet these requirements. If it is possible for inputs without attenuators (such as the 2.5V or 3.3V supplies) to be turned on while LM78 is powered off, additional resistors of about 10 kΩ should be added in series with the inputs to limit the input current.

### 5.0 LAYOUT AND GROUNDING

Analog inputs will provide best accuracy when referred to the AGND pin. A separate, low-impedance ground plane for analog ground, which provides a ground point for the voltage dividers and analog components, will provide best performance but is not mandatory. Analog components such as voltage dividers and feedback resistors should be located physically as close as possible to the LM78.

The power supply bypass, the parallel combination of 10 μF (electrolytic or tantalum) and 0.1 μF (ceramic) bypass capacitors connected between pin 12 and ground, should also be located as close as possible to the LM78.

### 6.0 FAN INPUTS

Inputs are provided for signals from fans equipped with tachometer outputs. These are logic-level inputs with an approximate threshold of 1.4V. Signal conditioning in the LM78 accommodates the slow rise and fall times typical of fan tachometer outputs. The maximum input signal range is

0 to V<sub>CC</sub>. In the event these inputs are supplied from fan outputs which exceed 0 to V<sub>CC</sub>, either resistive division or diode clamping must be included to keep inputs within an acceptable range, as shown in *Figure 9*. R2 is selected so that it does not develop excessive voltage due to input leakage. R1 is selected based on R2 to provide a minimum input of 2V and a maximum of V<sub>CC</sub>. R1 should be as low as possible to provide the maximum possible input up to V<sub>CC</sub> for best noise immunity. Alternatively, use a shunt reference or zener diode to clamp the input level.

If fans can be powered while the power to the LM78 is off, the LM78 inputs will provide diode clamping. Limit input current to the Input Current at Any Pin specification shown in the ABSOLUTE MAXIMUM RATINGS section. In most cases, open collector outputs with pull-up resistors inherently limit this current. If this maximum current could be exceeded, either a larger pull up resistor should be used or resistors connected in series with the fan inputs.

The Fan Inputs gate an internal 22.5 kHz oscillator for one period of the Fan signal into an 8-bit counter (maximum count = 255). The default divisor, located in the VID/Fan Divisor Register, is set to 2 (choices are 1, 2, 4, and 8) providing a nominal count of 153 for a 4400 rpm fan with two pulses per revolution. Typical practice is to consider 70% of normal RPM a fan failure, at which point the count will be 219.

Determine the fan count according to:

$$\text{Count} = \frac{1.35 \times 10^6}{\text{RPM} \times \text{Divisor}}$$

Note that Fan 1 and Fan 2 Divisors are programmable via the VID/Fan Divisor Register. Fan 3 is not adjustable, and its Divisor is always set to 2.

Fans that provide only one pulse per revolution would require a divisor set twice as high as fans that provide two pulses, thus maintaining a nominal fan count of 153. Therefore, the divisor should be set to 4 for a fan that provides 1 pulse per revolution with a nominal RPM of 4400.

## Functional Description (Continued)

Voltage Measurements ( $V_S$ )	R1 or $R_{IN}$	R2 or $R_F$	Voltage at Analog Inputs
+2.50V	0	NONE	+2.50V
+3.30V	0	NONE	+3.30V
+5V	6.8 k $\Omega$	10 k $\Omega$	+2.98V
+12V	30 k $\Omega$	10 k $\Omega$	+3.00V
-12V	240 k $\Omega$	60 k $\Omega$	+3.00V
-5V	100 k $\Omega$	60 k $\Omega$	+3.00V

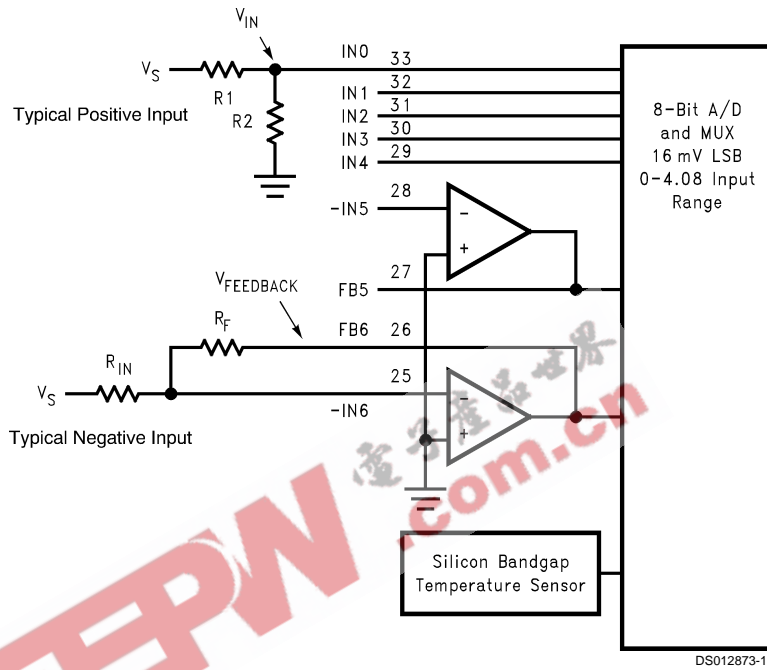
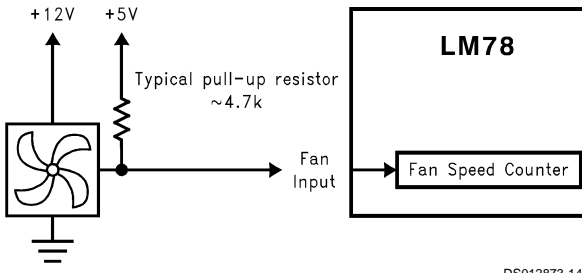

FIGURE 8. Input Examples. Resistor Values Shown Provide Approximately 3V at the Analog Inputs

Functional Description (Continued)



(a) Fan with Tach Pull-Up to +5V

DS012873-14

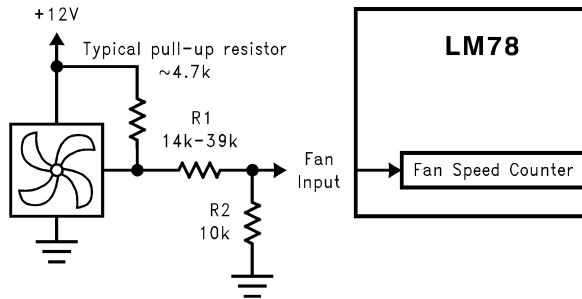

(b) Fan with Tach Pull-Up to +12V, or Totem-Pole Output and Resistor Attenuator

DS012873-15

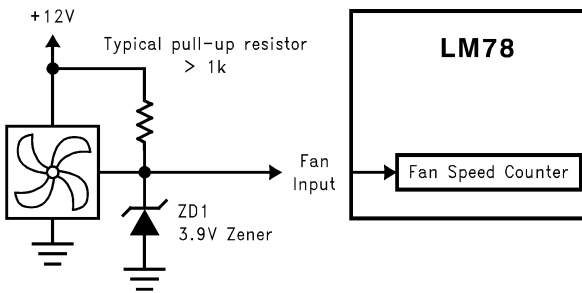

(c) Fan with Tach Pull-Up to +12V and Diode Clamp

DS012873-16

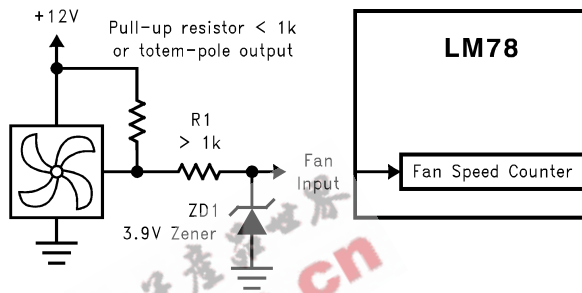

(d) Fan with Strong Tach Pull-Up or Totem Pole Output and Diode Clamp

DS012873-17

FIGURE 9. Alternatives for Fan Inputs

Counts are based on 2 pulses per revolution tachometer outputs.

RPM	Time per Revolution	Counts for "Divide by 2" (Default) in Decimal	Comments
4400	13.64 ms	153 counts	Typical RPM
3080	19.48 ms	219 counts	70% RPM
2640	22.73 ms	255 counts (maximum counts)	60% RPM

Mode Select	Nominal RPM	Time per Revolution	Counts for the Given Speed in Decimal	70% RPM	Time per Revolution for 70% RPM
Divide by 1	8800	6.82 ms	153	6160	9.74 ms
Divide by 2	4400	13.64 ms	153	3080	19.48 ms
Divide by 4	2200	27.27 ms	153	1540	38.96 ms
Divide by 8	1100	54.54 ms	153	770	77.92 ms

$$\text{Count} = \frac{1.35 \times 10^6}{\text{RPM} \times \text{Divisor}}$$

## Functional Description (Continued)

### 7.0 TEMPERATURE MEASUREMENT SYSTEM

The LM78 bandgap type temperature sensor and ADC perform 8-bit two's-complement conversions of the temperature. A digital comparator is also incorporated that compares the readings to the user-programmable Overtemperature setpoint and Hysteresis values.

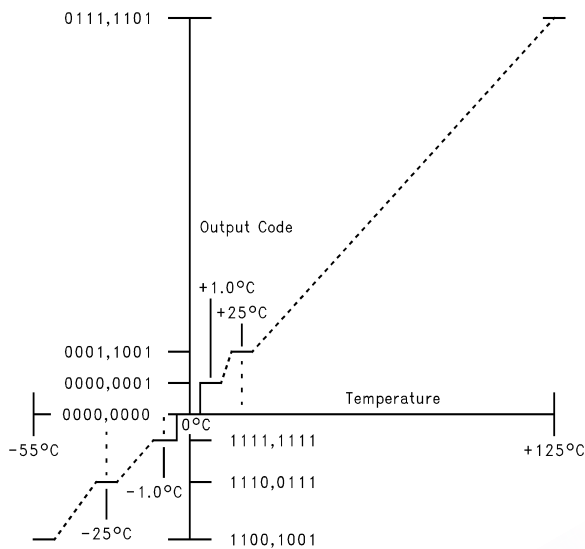

**FIGURE 10. Temperature-to-Digital Transfer Function (Non-Linear Scale for Clarity)**

### 7.1 Temperature Data Format

Temperature data can be read from the Temperature,  $T_{OI}$  Set Point, and  $T_{HYST}$  Set Point registers; and written to the  $T_{OI}$  Set Point, and  $T_{HYST}$  Set Point registers. Temperature data is represented by an 8-bit, two's complement word with an LSB (Least Significant Bit) equal to  $1.0^{\circ}\text{C}$ :

Temperature	Digital Output	
	Binary	Hex
+125°C	0111 1101	7Dh
+25°C	0001 1001	19h
+1.0°C	0000 0001	01h
+0°C	0000 0000	00h
-1.0°C	1111 1111	FFh
-25°C	1110 0111	E7h
-55°C	1100 1001	C9h

### 7.2 Temperature Interrupts

The normal mode for temperature interrupts in the LM78 is an "Interrupt" mode operating in the following way: Exceeding  $T_{OI}$  causes an interrupt that will remain active indefinitely until reset by reading Interrupt Status Register 1. Once an interrupt event has occurred by crossing  $T_{OI}$ , then reset, an interrupt will only occur again by the temperature going below  $T_{HYST}$ . Again, it will remain active indefinitely until being reset by reading Interrupt Status Register 1.

A "Comparator" mode for temperature interrupts can be made available by setting the  $T_{HYST}$  limit to  $127^{\circ}\text{C}$ . This results in a simple "thermostat" type of function where an interrupt will be set whenever the temperature exceeds the  $T_{OI}$  limit. Reading Interrupt Status Register 1 will clear the interrupt as usual, but the interrupt will set again after the completion of another measurement cycle. It will remain set until the temperature goes below the  $T_{OI}$  limit (allow up to two measurement cycles for clearing after descending below  $T_{OI}$  while in Comparator mode).

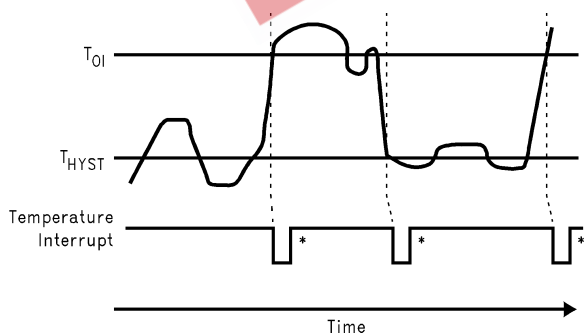

\*Note: Interrupt resets occur only when interrupt Status Register 1 is read.

**(a) Interrupt Mode**

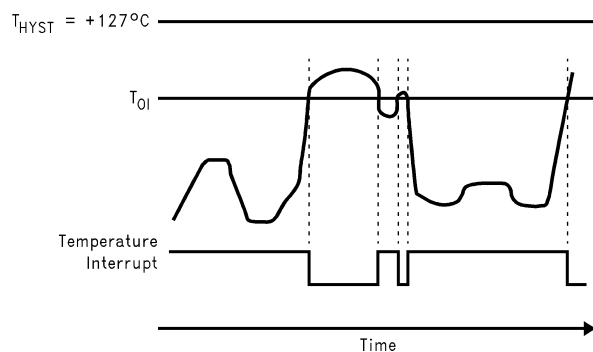

Interrupt resets occur when Interrupt Status Register 1 is read but will set again when monitoring cycle continues (as long as temperature exceeds  $T_{OI}$ ). When temperature descends below  $T_{OI}$  allow up to two monitoring loops before the Temperature Interrupt resets.

**(b) Comparator Mode**

**FIGURE 11. Temperature Interrupt Response Diagram**

## Functional Description (Continued)

### 8.0 THE LM78 INTERRUPT STRUCTURE

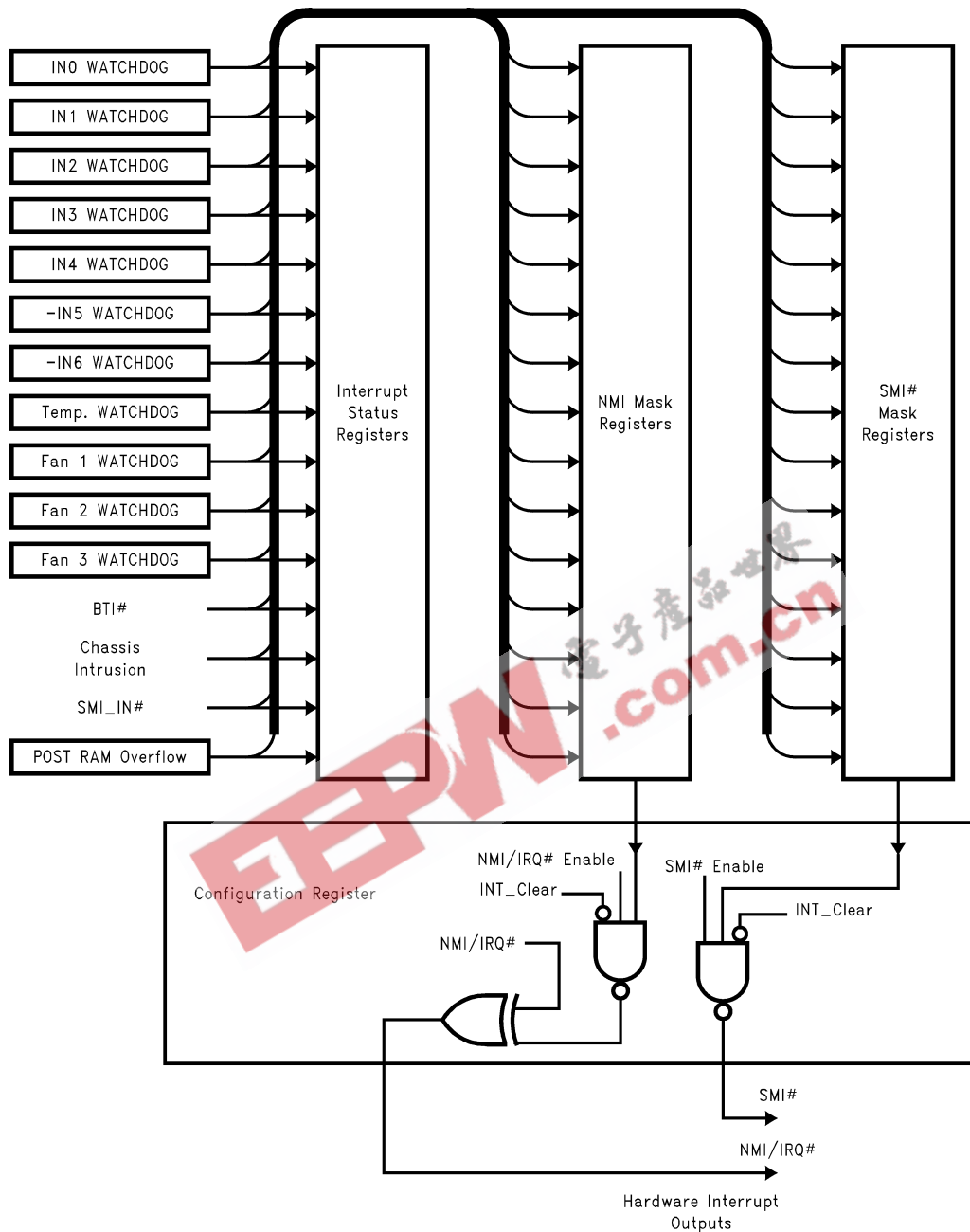

DS012873-21

**FIGURE 12. Interrupt Structure**

Figure 12 depicts the Interrupt Structure of the LM78. The LM78 can generate Interrupts as a result of each of its internal WATCHDOG registers on the analog, temperature, and fan inputs. Overflow of the POST RAM (greater than 32 bytes written to POST RAM) will also cause an Interrupt.

External Interrupts can come from the following three sources. While the labels suggest a specific type or source of Interrupt, these labels are not restrictions of their usage, and they could come from any desired source:

- **BTI:** This is an active low Interrupt intended to come from the O.S. output of LM75 temperature sensors. The LM75 O.S. output goes active when its temperature ex-

ceeds a programmed threshold. Up to 8 LM75's can be connected to a single Serial Bus bus with their O.S. output's wire or'd to the BTI input of the LM78. If the temperature of any LM75 exceeds its programmed limit, it drives  $\overline{\text{BTI}}$  low. This generates an Interrupt to notify the host of a possible overtemperature condition. Provides an internal pull-up of 10 k $\Omega$ .

## Functional Description (Continued)

- **Chassis Intrusion:** This is an active high interrupt from any type of device that detects and captures chassis intrusion violations. This could be accomplished mechanically, optically, or electrically, and circuitry external to the LM78 is expected to latch the event. The design of the LM78 allows this input to go high even with no power applied to the LM78, and no clamping or other interference with the line will occur. This line can also be pulled low for at least 20 ms by the LM78 to reset a typical Chassis Intrusion circuit. Accomplish this reset by setting Bit 7 of NMI Mask Register 2 high. The bit in the Register is self-clearing.
- **SMI $\overline$ IN:** This active low Interrupt merely provides a way to chain the SMI Interrupt from other devices through the LM78 to the processor.

All Interrupts are indicated in the two Interrupt Status Registers. The NMI/IRQ and SMI outputs have individual mask registers, and individual masks for each Interrupt. As described in Section 3.3, these two hardware Interrupt lines can also be enabled/disabled in the Configuration Register. The Configuration Register is also used to set the mode of the NMI/IRQ Interrupt line.

### 8.1 Interrupt Clearing

Reading the Interrupt Status Register will output the contents of the Register, and reset the Register. A subsequent read done before the analog "round-robin" monitoring loop is complete will indicate a cleared Register. Allow at least 1.5 seconds to allow all Registers to be updated between reads. In summary, the Interrupt Status Register clears upon being read, and requires at least 1.5 seconds to be updated. When the Interrupt Status Register clears, the hardware interrupt line will also clear until the Registers are updated by the monitoring loop.

The hardware Interrupt lines are cleared with the INT $\overline$ Clear bit, which is Bit 3 of the Configuration Register. When this bit is high, the LM78 monitoring loop will stop. It will resume when the bit is low.

### 9.0 RESET AND Power Switch Bypass OUTPUTS

In PC applications the Power Switch Bypass provides a gate drive signal to an external P-channel MOSFET power switch. This external MOSFET then would keep power turned on regardless of the state of front panel power switches when software power control is used. In any given application this signal is not limited to the function described by its label. For example, since the LM78 incorporates temperature sensing, the Power Switch Bypass output could also be utilized to control power to a cooling fan. Take Power Switch Bypass active low by setting Bit 6 in the Configuration Register high.

RESET is intended to provide a master reset to devices connected to this line. SMI Mask Register 2, Bit 7, must be set high to enable this function. Setting Bit 4 in the Configuration Register high outputs a least 20 ms low on this line, at the end of which Bit 4 in the Configuration Register automatically clears. Again, the label for this pin is only its suggested use. In applications where the RESET capability is not needed it can be used for any type of digital control that requires a 20 ms active low open drain output.

### 10.0 POST RAM

The POST RAM is located at address x0h and x4h, which typical address decoders will decode to 80h or 84h, where the BIOS will output Power On Self Test codes. A write to the

POST RAM auto-increments the internal pointer of the LM78. Up to 32 bytes may be stored. An excess of 32 bytes will generate an Interrupt and stop incrementing.

The POST RAM is read as like any other register at Ports x5h and x6h, with the POST RAM located at the LM78 Internal Address from 00h to 1Fh. Reading the POST RAM via x6h will also auto-increment, but this is a separate pointer than the one used for ports 80h and 84h.

### 11.0 NAND TREE TESTS

A NAND tree is provided in the LM78 for Automated Test Equipment (ATE) board level connectivity testing. NAND tree tests are accomplished in either power on reset or Configuration Register reset state, with the Start Bit, Bit 0 of the Configuration Register low, and the INT $\overline$ Clear (Bit 3) high. In this mode, forcing the SMI output low takes all pins except Power Switch Bypass, RESET, -IN5, -IN6, V $_{CC}$ , GNDA, and GNDD to a high impedance (either TRI-STATE or open drain) state. All high impedance pins can be taken to 0 and V $_{CC}$  to accomplish NAND tree tests.

To perform a NAND tree test all pins included in the NAND tree should be driven to 1. Each individual pin (excluding the aforementioned exceptions) can be toggled and the resulting toggle observed on the NTEST pin. Allow for a typical propagation delay of 200 ns.

## Functional Description (Continued)

### 12.0 FAN MANUFACTURERS

Manufacturers of cooling fans with tachometer outputs are listed below:

#### NMB Tech

9730 Independence Ave.  
Chatsworth, California 91311  
818 341-3355  
818 341-8207

Model Number	Frame Size	Airflow CFM
<b>2408NL</b>	2.36 in sq. X 0.79 in (60 mm sq. X 20 mm)	9-16
<b>2410ML</b>	2.36 in sq. X 0.98 in (60 mm sq. X 25 mm)	14-25
<b>3108NL</b>	3.15 in sq. X 0.79 in (80 mm sq. X 20 mm)	25-42
<b>3110KL</b>	3.15 in sq. X 0.98 in (80 mm sq. X 25 mm)	25-40

#### Mechatronics Inc.

P.O. Box 20  
Mercer Island, WA 98040  
800 453-4569

Various sizes available with tach output option.

#### Sanyo Denki America, Inc.

468 Amapola Ave.  
Torrance, CA 90501  
310 783-5400

Model Number	Frame Size	Airflow CFM
<b>109P06XXY601</b>	2.36 in sq. X 0.79 in (60 mm sq. X 20 mm)	11-15
<b>109R06XXY401</b>	2.36 in sq. X 0.98 in (60 mm sq. X 25 mm)	13-28
<b>109P08XXY601</b>	3.15 in sq. X 0.79 in (80 mm sq. X 20 mm)	23-30
<b>109R08XXY401</b>	3.15 in sq. X 0.98 in (80 mm sq. X 25 mm)	21-42

## Functional Description (Continued)

### REGISTERS AND RAM

#### 13.1 Address Register (Port x5h)

The main register is the ADDRESS Register located at Port x5h. The bit designations are as follows:

Bit	Name	Read/Write	Description
6-0	Address Pointer	Read/Write	Address of RAM and Registers. See the tables below for detail.
7	Busy	Read Only	<p>A one indicates the device is busy because of a Serial Bus transaction or another ISA bus transaction. With checking this bit, multiple ISA drivers can use LM78 without interfering with each other or a Serial Bus driver.</p> <p>It is the user's responsibility not to have a Serial Bus and ISA bus operations at the same time.</p> <p>This bit is:</p> <p><b>Set:</b> with a write to Port x5h or when a Serial Bus transaction is in progress.</p> <p><b>Reset:</b> with a write or read from Port x6h if it is set by a write to Port x5h, or when the Serial Bus transaction is finished.</p>

Bit 7	Bit 6	Bit 5	Bit 4	Bit 3	Bit 2	Bit 1	Bit 0
Busy (Power On default 0)	Address Pointer (Power On default 00h)						
	A6	A5	A4	A3	A2	A1	A0

#### Address Pointer Index (A6–A0)

Registers and RAM	A6–A0 in Hex	Power On Value of Registers: <7:0> in Binary	Notes
Configuration Register	40h	0000 1000	
Interrupt Status Register 1	41h	0000 0000	Auto-increment to the address of Interrupt Status Register 2 after a read or write to Port x6h.
Interrupt Status Register 2	42h	0000 0000	
S $\bar{M}$ I Mask Register 1	43h	0000 0000	Auto-increment to the address of S $\bar{M}$ I Mask Register 2 after a read or write to Port x6h.
S $\bar{M}$ I Mask Register 2	44h	0000 0000	
NMI Mask Register 1	45h	0000 0000	Auto-increment to the address of NMI Mask Register 2 after a read or write to Port x6h.
NMI Mask Register 2	46h	0100 0000	
VID/Fan Divisor Register	47h	<7:4> = 0101; <3:0> = VID3–VID0	
Serial Bus Address Register	48h	0010 1101	
Chip Reset/ID Register	49h	0100 0000	
POST RAM	00–1Fh		Auto-increment to the next location after a read or write to Port x6h and stop at 1Fh.
Value RAM	20–3Fh		
Value RAM	60–7Fh		Auto-increment to the next location after a read or write to Port x6h and stop at 7Fh.



## Functional Description (Continued)

### 13.2 Data Register (Port x6h)

Power on default <7:0> = 00h

Bit	Name	Read/ Write	Description
7–0	Data	Read/Write	Data to be read from or to be written to RAM and Register.

### 13.3 Configuration Register — Address 40h

Power on default <7:0> = 00001000 binary

Bit	Name	Read/ Write	Description
0	Start	Read/Write	A one enables startup of monitoring operations, a zero puts the part in standby mode. <b>Note:</b> The outputs of Interrupt pins will not be cleared if the user writes a zero to this location after an interrupt has occurred unlike "INT__Clear" bit.
1	$\overline{\text{SMI}}$ Enable	Read/Write	A one enables the $\overline{\text{SMI}}$ Interrupt output.
2	$\overline{\text{NMI/IRQ}}$ Enable	Read/Write	A one enables the $\overline{\text{NMI/IRQ}}$ Interrupt output.
3	INT__Clear	Read/Write	A one disables the $\overline{\text{SMI}}$ and $\overline{\text{NMI/IRQ}}$ outputs without affecting the contents of Interrupt Status Registers. The device will stop monitoring. It will resume upon clearing of this bit.
4	$\overline{\text{RESET}}$	Read/Write	A one outputs at least a 20 ms active low reset signal at $\overline{\text{RESET}}$ if <7> = 1 in $\overline{\text{SMI}}$ Mask Register 2. This bit is cleared once the pulse has gone inactive.
5	$\overline{\text{NMI/IRQ}}$ Select	Read/Write	A one selects NMI, and a zero selects $\overline{\text{IRQ}}$ .
6	$\overline{\text{Power Switch Bypass}}$	Read/Write	A one in this bit drives a zero on $\overline{\text{Power Switch Bypass}}$ pin.
7	INITIALIZATION	Read/Write	A one restores power on default value to all registers <b>except</b> the Serial Bus Address register. This bit clears itself since the power on default is zero.

## Functional Description (Continued)

### 13.4 Interrupt Status Register 1—Address 41h

Power on default <7:0> = 00h

Bit	Name	Read/Write	Description
0	IN0	Read Only	A one indicates a High or Low limit has been exceeded.
1	IN1	Read Only	A one indicates a High or Low limit has been exceeded.
2	IN2	Read Only	A one indicates a High or Low limit has been exceeded.
3	IN3	Read Only	A one indicates a High or Low limit has been exceeded.
4	Temperature	Read Only	A one indicates a High or Low limit has been exceeded.
5	$\overline{\text{BTI}}$	Read Only	A one indicates an interrupt has occurred from the Board Temperature Interrupt ( $\overline{\text{BTI}}$ ) input (O.S. output of multiple LM75 chips).
6	FAN1	Read Only	A one indicates the fan count limit has been exceeded.
7	FAN2	Read Only	A one indicates the fan count limit has been exceeded.

### 13.5 Interrupt Status Register 2—Address 42h

Power on default <7:0> = 00h

Bit	Name	Read/Write	Description
0	IN4	Read Only	A one indicates a High or Low limit has been exceeded.
1	-IN5	Read Only	A one indicates a High or Low limit has been exceeded.
2	-IN6	Read Only	A one indicates a High or Low limit has been exceeded.
3	FAN3	Read Only	A one indicates the fan count limit has been exceeded.
4	Chassis Intrusion	Read Only	A one indicates Chassis Intrusion has gone high.
5	FIFO Overflow	Read Only	A one indicates an overflow in FIFO (POST RAM) i.e. 32nd location in FIFO has been written via Port x0h or x4h.
6	$\overline{\text{SMI\_IN}}$	Read Only	A one indicates $\overline{\text{SMI\_IN}}$ has gone low.
7	Reserved	Read Only	

### 13.6 $\overline{\text{SMI}}$ Mask Register 1—Address 43h

Power on default <7:0> = 00h

Bit	Name	Read/Write	Description
0	IN0	Read/Write	A one disables the corresponding interrupt status bit for $\overline{\text{SMI}}$ interrupt.
1	IN1	Read/Write	A one disables the corresponding interrupt status bit for $\overline{\text{SMI}}$ interrupt.
2	IN2	Read/Write	A one disables the corresponding interrupt status bit for $\overline{\text{SMI}}$ interrupt.
3	IN3	Read/Write	A one disables the corresponding interrupt status bit for $\overline{\text{SMI}}$ interrupt.
4	Temperature	Read/Write	A one disables the corresponding interrupt status bit for $\overline{\text{SMI}}$ interrupt.
5	$\overline{\text{BTI}}$	Read/Write	A one disables the corresponding interrupt status bit for $\overline{\text{SMI}}$ interrupt.
6	FAN1	Read/Write	A one disables the corresponding interrupt status bit for $\overline{\text{SMI}}$ interrupt.
7	FAN2	Read/Write	A one disables the corresponding interrupt status bit for $\overline{\text{SMI}}$ interrupt.

## Functional Description (Continued)

### 13.7 $\overline{\text{SMI}}$ Mask Register 2— Address 44h

Power on default <7:0> = 00h

Bit	Name	Read/Write	Description
0	IN4	Read/Write	A one disables the corresponding interrupt status bit for $\overline{\text{SMI}}$ interrupt.
1	-IN5	Read/Write	A one disables the corresponding interrupt status bit for $\overline{\text{SMI}}$ interrupt.
2	-IN6	Read/Write	A one disables the corresponding interrupt status bit for $\overline{\text{SMI}}$ interrupt.
3	FAN3	Read/Write	A one disables the corresponding interrupt status bit for $\overline{\text{SMI}}$ interrupt.
4	Chassis Intrusion	Read/Write	A one disables the corresponding interrupt status bit for $\overline{\text{SMI}}$ interrupt.
5	FIFO Overflow	Read/Write	A one disables the corresponding interrupt status bit for $\overline{\text{SMI}}$ interrupt.
6	$\overline{\text{SMI}}\_IN$	Read/Write	A one disables the corresponding interrupt status bit for $\overline{\text{SMI}}$ interrupt.
7	RESET Enable	Read/Write	<7> = 1 in $\overline{\text{SMI}}$ Mask Register 2 enables the RESET in the Configuration Register.

### 13.8 NMI Mask Register 1— Address 45h

Power on default <7:0> = 00h

Bit	Name	Read/Write	Description
0	IN0	Read/Write	A one disables the corresponding interrupt status bit for $\overline{\text{NMI}}/\overline{\text{IRQ}}$ interrupt.
1	IN1	Read/Write	A one disables the corresponding interrupt status bit for $\overline{\text{NMI}}/\overline{\text{IRQ}}$ interrupt.
2	IN2	Read/Write	A one disables the corresponding interrupt status bit for $\overline{\text{NMI}}/\overline{\text{IRQ}}$ interrupt.
3	IN3	Read/Write	A one disables the corresponding interrupt status bit for $\overline{\text{NMI}}/\overline{\text{IRQ}}$ interrupt.
4	Temperature	Read/Write	A one disables the corresponding interrupt status bit for $\overline{\text{NMI}}/\overline{\text{IRQ}}$ interrupt.
5	$\overline{\text{BTI}}$	Read/Write	A one disables the corresponding interrupt status bit for $\overline{\text{NMI}}/\overline{\text{IRQ}}$ interrupt.
6	FAN1	Read/Write	A one disables the corresponding interrupt status bit for $\overline{\text{NMI}}/\overline{\text{IRQ}}$ interrupt.
7	FAN2	Read/Write	A one disables the corresponding interrupt status bit for $\overline{\text{NMI}}/\overline{\text{IRQ}}$ interrupt.

### 13.9 NMI Mask Register 2— Address 46h

Power on <7:0> = 01000000 binary

Bit	Name	Read/Write	Description
0	IN4	Read/Write	A one disables the corresponding interrupt status bit for $\overline{\text{NMI}}/\overline{\text{IRQ}}$ interrupt.
1	-IN5	Read/Write	A one disables the corresponding interrupt status bit for $\overline{\text{NMI}}/\overline{\text{IRQ}}$ interrupt.
2	-IN6	Read/Write	A one disables the corresponding interrupt status bit for $\overline{\text{NMI}}/\overline{\text{IRQ}}$ interrupt.
3	FAN3	Read/Write	A one disables the corresponding interrupt status bit for $\overline{\text{NMI}}/\overline{\text{IRQ}}$ interrupt.
4	Chassis Intrusion	Read/Write	A one disables the corresponding interrupt status bit for $\overline{\text{NMI}}/\overline{\text{IRQ}}$ interrupt.
5	FIFO Overflow	Read/Write	A one disables the corresponding interrupt status bit for $\overline{\text{NMI}}/\overline{\text{IRQ}}$ interrupt.
6	$\overline{\text{SMI}}\_IN$	Read/Write	A one disables the corresponding interrupt status bit for $\overline{\text{NMI}}/\overline{\text{IRQ}}$ interrupt. <b>Note:</b> The Power on default is 1 for this bit.
7	Chassis Clear	Read/Write	A one outputs a minimum 20 ms active low pulse on the Chassis Intrusion pin. The register bit self clears after the pulse has been output.

## Functional Description (Continued)

### 13.10 VID/Fan Divisor Register— Address 47h

Power on – <7:4> is 0101, and <3:0> is mapped to VID <3:0>

Bit	Name	Read/Write	Description
3-0	VID <3:0>	Read Only	The VID <3:0> inputs
5-4	FAN1 RPM Control	Read/Write	FAN1 Speed Control.  <5:4> = 00 - divide by 1; <5:4> = 01 - divide by 2; <5:4> = 10 - divide by 4; <5:4> = 11 - divide by 8.
7-6	FAN2 RPM Control	Read/Write	FAN2 Speed Control.  <7:6> = 00 - divide by 1; <7:6> = 01 - divide by 2; <7:6> = 10 - divide by 4; <7:6> = 11 - divide by 8.

### 13.11 Serial Bus Address Register— Address 48h

Power on default Serial Bus address <6:0> = 0101101 and <7> = 0 binary

Bit	Name	Read/Write	Description
6-0	Serial Bus Address	Read/Write	Serial Bus address <6:0>
7	Reserved	Read Only	

### 13.12 Chip Reset/ID Register Address 49h

Power on default for the LM78-J <7:0> = 0100 0000; Power on default for LM78 <7:0> = 0000 0000.

Bit	Name	Read/Write	Description
0-4	Reserved	Read Only	
5	Chip Reset	Read/Write	A one will reset all the registers of the LM78 to the power on default state.
6	Device ID	Read Only	When set the latest version of the LM78 the LM78-J is being used. When cleared designates the old version of LM78.
7	Reserved	Read Only	

### 13.13 POST RAM— Address 00h–1Fh

The address pointer for the POST RAM auto-increments when written to at Port x0h or x4h. Once the address pointer reaches 1Fh, a FIFO overflow interrupt will be generated and the FIFO will stop incrementing. Normal reads via Port x5h and x6h auto-increment a separate pointer, and will not cause a FIFO overflow interrupt.

### 13.14 Value RAM— Address 20h–3Fh or 60h–7Fh (auto-increment)

Address A6–A0	Address A6–A0 with Auto-Increment	Description
20h	60h	IN0 reading
21h	61h	IN1 reading
22h	62h	IN2 reading
23h	63h	IN3 reading
24h	64h	IN4 reading
25h	65h	-IN5 reading
26h	66h	-IN6 reading
27h	67h	Temperature reading
28h	68h	FAN1 reading

## Functional Description (Continued)

Address A6–A0	Address A6–A0 with Auto-Increment	Description
		<b>Note:</b> This location stores the number of counts of the internal clock per revolution.
29h	69h	FAN2 reading <b>Note:</b> This location stores the number of counts of the internal clock per revolution.
2Ah	6Ah	FAN3 reading <b>Note:</b> This location stores the number of counts of the internal clock per revolution.
2Bh	6Bh	IN0 High Limit
2Ch	6Ch	IN0 Low Limit
2Dh	6Dh	IN1 High Limit
2Eh	6Eh	IN1 Low Limit
2Fh	6Fh	IN2 High Limit
30h	70h	IN2 Low Limit
31h	71h	IN3 High Limit
32h	72h	IN3 Low Limit
33h	73h	IN4 High Limit
34h	74h	IN4 Low Limit
35h	75h	-IN5 High Limit
36h	76h	-IN5 Low Limit
37h	77h	-IN6 High Limit
38h	78h	-IN6 Low Limit
39h	79h	Over Temperature Limit (High)
3Ah	7Ah	Temperature Hysteresis Limit (Low)
3Bh	7Bh	FAN1 Fan Count Limit <b>Note:</b> It is the number of counts of the internal clock for the Low Limit of the fan speed.
3Ch	7Ch	FAN2 Fan Count Limit <b>Note:</b> It is the number of counts of the internal clock for the Low Limit of the fan speed.
3Dh	7Dh	FAN3 Fan Count Limit <b>Note:</b> It is the number of counts of the internal clock for the Low Limit of the fan speed.
3E–3Fh	7E–7Fh	Reserved

**Note:** Setting all ones to the high limits for voltages and fans (0111 1111 binary for temperature) means interrupts will **never** be generated except the case when voltages go below the low limits.

For voltage input high limits, the device is doing > comparison. For low limits, however, it is doing ≤ comparison.

# Typical Application

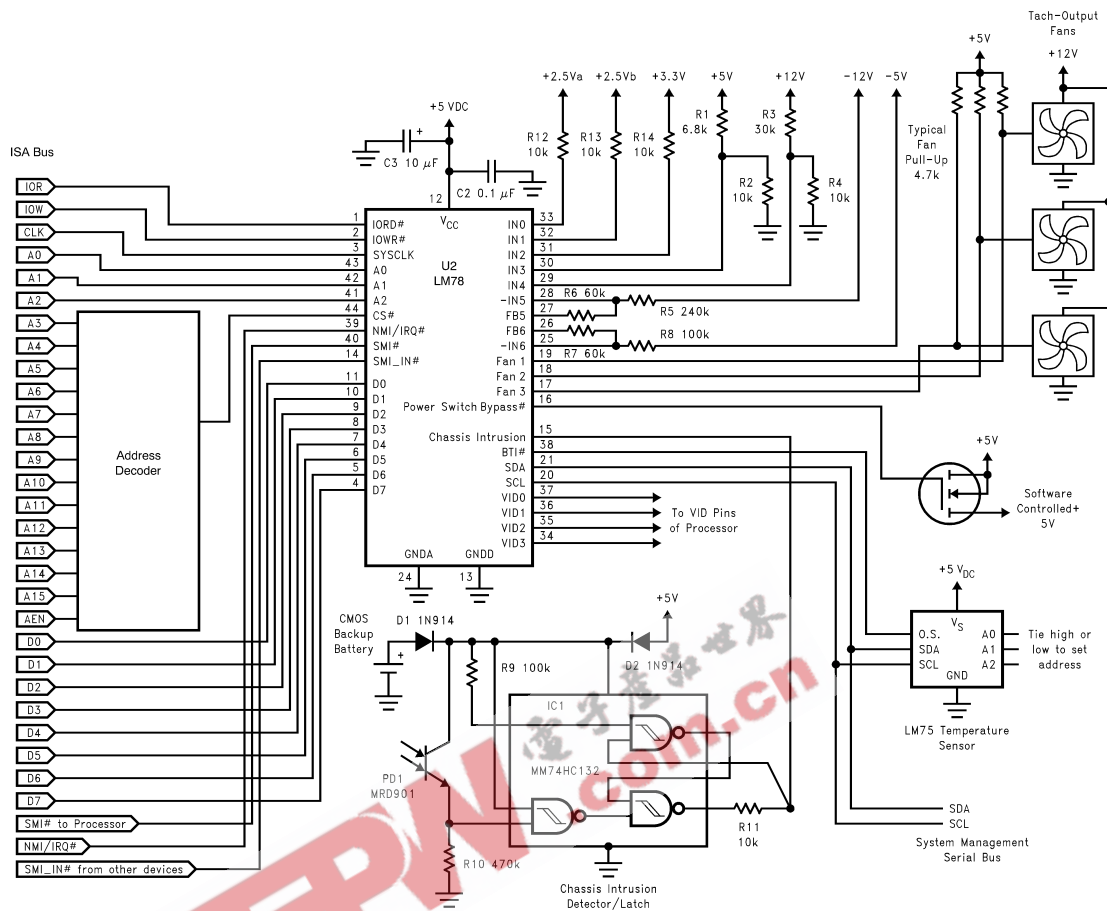

DS012873-22

**FIGURE 13.** In this PC application the LM78 monitors temperature, fan speed for 3 fans, and 7 power supply voltages. It also monitors the O.S. Output of up to 8 LM75 digital temperature sensors as well as an optical chasis intrusion detector.

**Physical Dimensions** inches (millimeters) unless otherwise noted

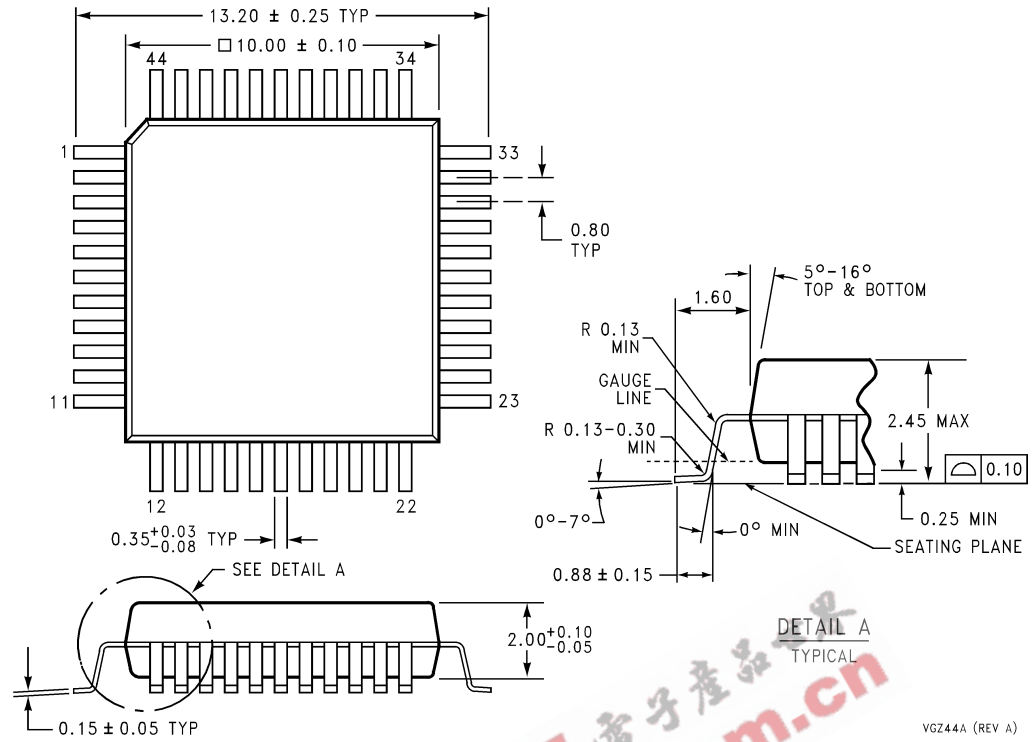

**44-Lead (10 mm x 10 mm) Molded Plastic Quad Flatpak**  
**Order Number LM78CCVF-J**  
**NS Package Number VGZ44A**

**LIFE SUPPORT POLICY**

NATIONAL'S PRODUCTS ARE NOT AUTHORIZED FOR USE AS CRITICAL COMPONENTS IN LIFE SUPPORT DEVICES OR SYSTEMS WITHOUT THE EXPRESS WRITTEN APPROVAL OF THE PRESIDENT AND GENERAL COUNSEL OF NATIONAL SEMICONDUCTOR CORPORATION. As used herein:

1. Life support devices or systems are devices or systems which, (a) are intended for surgical implant into the body, or (b) support or sustain life, and whose failure to perform when properly used in accordance with instructions for use provided in the labeling, can be reasonably expected to result in a significant injury to the user.
2. A critical component is any component of a life support device or system whose failure to perform can be reasonably expected to cause the failure of the life support device or system, or to affect its safety or effectiveness.

**National Semiconductor Corporation**  
 Americas  
 Tel: 1-800-272-9959  
 Fax: 1-800-737-7018  
 Email: support@nsc.com  
 www.national.com

**National Semiconductor Europe**  
 Fax: +49 (0) 180-530 85 86  
 Email: europe.support@nsc.com  
 Deutsch Tel: +49 (0) 69 9508 6208  
 English Tel: +44 (0) 870 24 0 2171  
 Français Tel: +33 (0) 1 41 91 8790

**National Semiconductor Asia Pacific Customer Response Group**  
 Tel: 65-2544466  
 Fax: 65-2504466  
 Email: ap.support@nsc.com

**National Semiconductor Japan Ltd.**  
 Tel: 81-3-5639-7560  
 Fax: 81-3-5639-7507