

LM4991 Boomer[®] Audio Power Amplifier Series

3W Audio Power Amplifier with Shutdown Mode

General Description

The LM4991 is a mono bridged audio power amplifier capable of delivering 3W of continuous average power into a 3Ω load with less than 10% THD when powered by a 5V power supply (Note 1). To conserve power in portable applications, the LM4991's micropower shutdown mode ($I_{SD} = 0.1\mu A$, typ) is activated when V_{DD} is applied to the SHUTDOWN pin.

Boomer audio power amplifiers are designed specifically to provide high power, high fidelity audio output. They require few external components and operate on low supply voltages from 2.2V to 5.5V. Since the LM4991 does not require output coupling capacitors, bootstrap capacitors, or snubber networks, it is ideally suited for low-power portable systems that require minimum volume and weight.

Additional LM4991 features include thermal shutdown protection, unity-gain stability, and external gain set.

Note 1: An LM4991LD that has been properly mounted to a circuit board will deliver 3W into 3Ω (at 10% THD). The other package options for the LM4991 will deliver 1.5W into 8Ω (at 10% THD). See the **Application Information** sections for further information concerning the LM4991LD and LM4991M.

Key Specifications

- Improved PSRR at 217kHz and 1kHz 64dB (typ)
- P_O at $V_{DD} = 5.0V$, 10% THD, 1kHz
- LM4991LD (only), 3Ω, 4Ω 3W (typ), 2.5W (typ)
- All packages, 8Ω load 1.5W (typ)
- Shutdown current 0.1μA (typ)

Features

- Available in space-saving LLP and MA packages
- Ultra low current shutdown mode
- Can drive capacitive loads up to 500pF
- Improved pop & click circuitry reduces noises during turn-on and turn-off transitions
- 2.2 - 5.5V operation
- No output coupling capacitors, snubber networks, bootstrap capacitors or gain-setting resistors required
- Unity-gain stable

Applications

- Wireless and cellular handsets
- PDA's
- Portable computers
- Desktop computers

Connection Diagrams

Small Outline Package

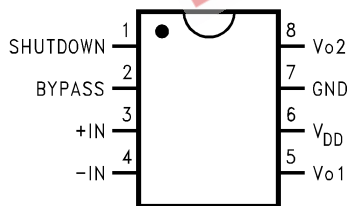

20074002

Top View
Order Number LM4991MA
See NS Package Number M08A

LLP Package

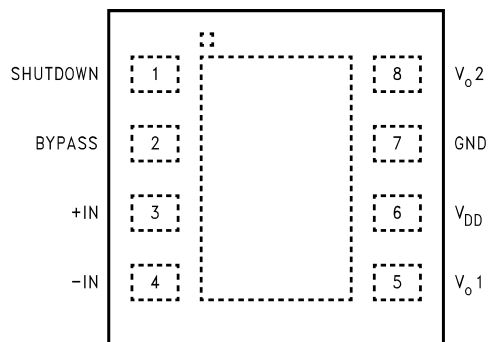

20074039

Top View
Order Number LM4991LD
See NS Package Number LDC08A

Typical Application

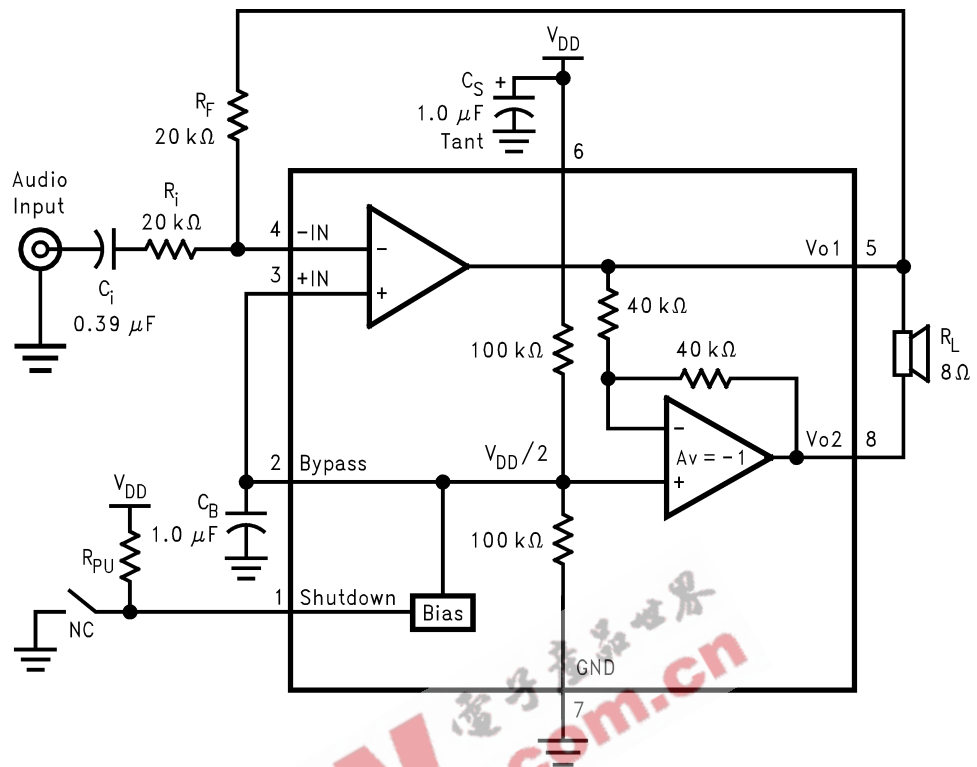

20074001

FIGURE 1. Typical Audio Amplifier Application Circuit

Absolute Maximum Ratings (Note 2)

If Military/Aerospace specified devices are required, please contact the National Semiconductor Sales Office/Distributors for availability and specifications.

Supply Voltage	6.0V
Supply Temperature	-65°C to +150°C
Input Voltage	-0.3V to V_{DD} to +0.3V
Power Dissipation (Note 4)	Internally Limited
ESD Susceptibility (Note 5)	2000V
ESD Susceptibility (Note 6)	200V
Junction Temperature	150°C

Thermal Resistance

θ_{JC} (LD) (Note 9)	4.3°C/W
θ_{JA} (LD)	56°C/W
θ_{JC} (MA)	35°C/W
θ_{JA} (MA)	140°C/W

Operating Ratings

Temperature Range

$T_{MIN} \leq T_A \leq T_{MAX}$	-40°C $\leq T_A \leq$ +85°C
Supply Voltage	2.2V $\leq V_{DD} \leq$ 5.5V

Electrical Characteristics $V_{DD} = 5V$ (Notes 2, 3)

The following specifications apply for $V_{DD} = 5V$ and $R_L = 8\Omega$ unless otherwise specified. Limits apply for $T_A = 25^\circ\text{C}$.

Symbol	Parameter	Conditions	LM4991		Units (Limits)
			Typical (Note 7)	Limit (Note 8)	
I_{DD}	Quiescent Power Supply Current	$V_{IN} = 0V$, no Load	3	7	mA (max)
		$V_{IN} = 0V$, $R_L = 8\Omega$	4	10	
I_{SD}	Shutdown Current	$V_{SHUTDOWN} = V_{DD}$	0.1	2.0	μA (max)
V_{SDIH}	Shutdown Voltage		1.5		V
V_{SDIL}			1.3		V
V_{OS}	Output Offset Voltage		5	35	mV (max)
P_O	Output Power	THD = 1% (max), $f = 1\text{kHz}$ LM4991LD, $R_L = 3\Omega$ (Note 10)	2.38	0.9	W (min)
		LM4991LD, $R_L = 4\Omega$ (Note 10)	2.1		
		LM4991, $R_L = 8\Omega$	1.3		
		THD+N = 10%, $f = 1\text{kHz}$ LM4991LD, $R_L = 3\Omega$ (Note 10)	3		
LM4991LD, $R_L = 4\Omega$ (Note 10)	2.5				
LM4991, $R_L = 8\Omega$	1.5				
THD+N	Total Harmonic Distortion+Noise	$P_O = 0.5W$, $f = 1\text{kHz}$	0.2		%
PSRR	Power Supply Rejection Ratio	$V_{RIPPLE} = 200\text{mV}$ sine p-p, Input terminated with 10Ω , $f = 1\text{kHz}$	64	55	dB (min)

Electrical Characteristics $V_{DD} = 3V$ (Notes 2, 3)

The following specifications apply for $V_{DD} = 3V$ and $R_L = 8\Omega$ unless otherwise specified. Limits apply for $T_A = 25^\circ\text{C}$.

Symbol	Parameter	Conditions	LM4991		Units (Limits)
			Typical (Note 7)	Limit (Note 8)	
I_{DD}	Quiescent Power Supply Current	$V_{IN} = 0V$, no Load	3	7	mA (max)
		$V_{IN} = 0V$, $R_L = 8\Omega$	4	7	
I_{SD}	Shutdown Current	$V_{SHUTDOWN} = V_{DD}$	0.1	2.0	μA (max)
V_{SDIH}	Shutdown Voltage Input High		1.1		V
V_{SDIL}	Shutdown Voltage Input Low		0.9		V
V_{OS}	Output Offset Voltage		5	35	mV (max)
P_O	Output Power	THD = 1% (max), $f = 1\text{kHz}$ $R_L = 4\Omega$	600		mW
		$R_L = 8\Omega$	425		
		THD+N = 0.1%, $f = 1\text{kHz}$	0.1		
THD+N	Total Harmonic Distortion+Noise	$P_O = 0.25W$, $f = 1\text{kHz}$	0.1		%

Electrical Characteristics $V_{DD} = 3V$ (Notes 2, 3)

The following specifications apply for $V_{DD} = 3V$ and $R_L = 8\Omega$ unless otherwise specified. Limits apply for $T_A = 25^\circ\text{C}$. (Continued)

Symbol	Parameter	Conditions	LM4991		Units (Limits)
			Typical (Note 7)	Limit (Note 8)	
PSRR	Power Supply Rejection Ratio	$V_{RIPPLE} = 200\text{mV}$ sine p-p, Input terminated with 10Ω , $f = 1\text{kHz}$	68		dB

Electrical Characteristics $V_{DD} = 2.6V$ (Notes 2, 3)

The following specifications apply for $V_{DD} = 2.6V$ and $R_L = 8\Omega$ unless otherwise specified. Limits apply for $T_A = 25^\circ\text{C}$.

Symbol	Parameter	Conditions	LM4991		Units (Limits)
			Typical (Note 7)	Limit (Note 8)	
I_{DD}	Quiescent Power Supply Current	$V_{IN} = 0V$, no Load	2		mA (max)
		$V_{IN} = 0V$, $R_L = 8\Omega$	3		
I_{SD}	Shutdown Current	$V_{SHUTDOWN} = V_{DD}$	0.1		μA (max)
V_{SDIH}	Shutdown Voltage Input High		1		V
V_{SDIL}	Shutdown Voltage Input Low		0.9		V
V_{OS}	Output Offset Voltage		5	35	mV (max)
P_o	Output Power	THD = 1% (max), $f = 1\text{kHz}$ $R_L = 4\Omega$	400		mW
		$R_L = 8\Omega$	300		
THD+N	Total Harmonic Distortion+Noise	$P_o = 0.15W$, $f = 1\text{kHz}$	0.1		%
PSRR	Power Supply Rejection Ratio	$V_{RIPPLE} = 200\text{mV}$ sine p-p, Input terminated with 10Ω , $f = 1\text{kHz}$	51		dB

Note 2: *Absolute Maximum Ratings* indicate limits beyond which damage to the device may occur. *Operating Ratings* indicate conditions for which the device is functional, but do not guarantee specific performance limits. *Electrical Characteristics* state DC and AC electrical specifications under particular test conditions which guarantee specific performance limits. This assumes that the device is within the Operating Ratings. Specifications are not guaranteed for parameters where no limit is given, however, the typical value is a good indication of device performance.

Note 3: All voltages are measured with respect to the ground pin, unless otherwise specified.

Note 4: The maximum power dissipation must be derated at elevated temperatures and is dictated by T_{JMAX} , θ_{JA} , and the ambient temperature T_A . The maximum allowable power dissipation is $P_{DMAX} = (T_{JMAX} - T_A) / \theta_{JA}$ or the number given in Absolute Maximum Ratings, whichever is lower. For the LM4991, $T_{JMAX} = 150^\circ\text{C}$. For the θ_{JA} 's for different packages, please see the **Application Information** section or the **Absolute Maximum Ratings** section.

Note 5: Human body model, 100pF discharged through a 1.5k Ω resistor.

Note 6: Machine Model, 220pF–240pF discharged through all pins.

Note 7: Typical values are specified at 25°C and represent the parametric norm.

Note 8: Limits are guaranteed to National's AOQL (Average Outgoing Quality Level).

Note 9: The given θ_{JA} is for an LM4991 packaged in an LDC08A with the Exposed–DAP soldered to an exposed 1in² area of 1oz printed circuit board copper.

Note 10: When driving 3 Ω or 4 Ω loads from a 5V supply, the LM4991LD must be mounted to a circuit board.

External Components Description

(Figure 1)

Components		Functional Description
1.	R_i	Inverting input resistance that sets the closed-loop gain in conjunction with R_f . This resistor also forms a high pass filter with C_i at $f_c = 1/(2\pi R_i C_i)$.
2.	C_i	Input coupling capacitor that blocks the DC voltage at the amplifiers input terminals. Also creates a highpass filter with R_i at $f_c = 1/(2\pi R_i C_i)$. Refer to the section, Proper Selection of External Components , for an explanation of how to determine the value of C_i .
3.	R_f	Feedback resistance that sets the closed-loop gain in conjunction with R_i .
4.	C_S	Supply bypass capacitor that provides power supply filtering. Refer to the Power Supply Bypassing section for information concerning proper placement and selection of the supply bypass capacitor.
5.	C_B	Bypass pin capacitor that provides half-supply filtering. Refer to the section, Proper Selection of External Components , for information concerning proper placement and selection of C_B .

Typical Performance Characteristics LD and MH Specific Characteristics

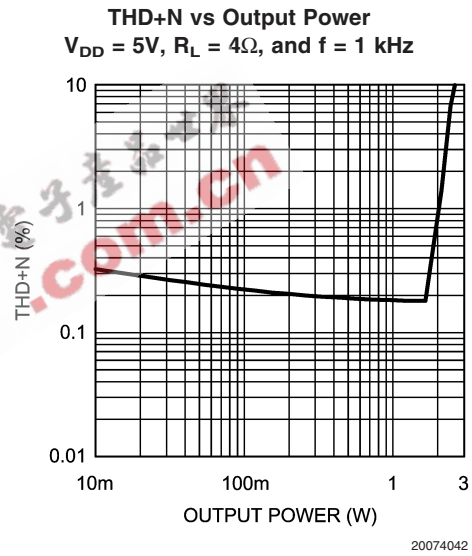
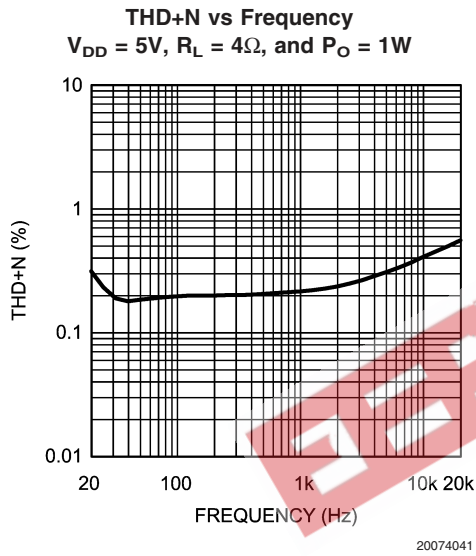

Typical Performance Characteristics

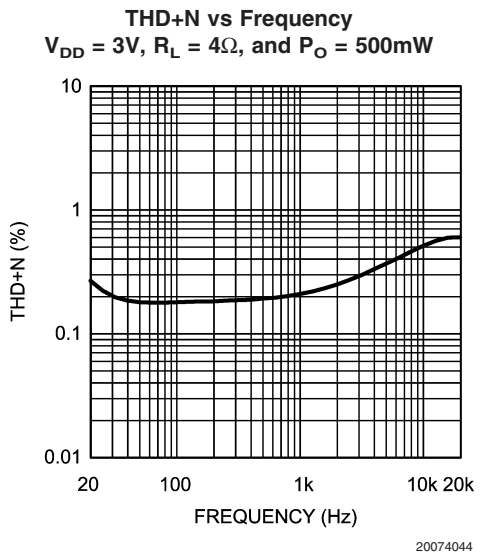
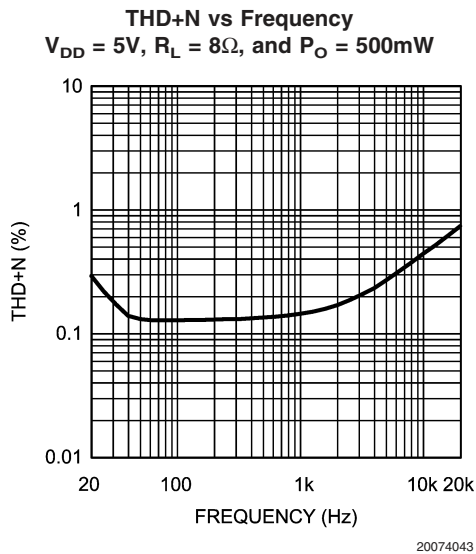

Typical Performance Characteristics (Continued)

THD+N vs Frequency
 $V_{DD} = 3V$, $R_L = 8\Omega$, and $P_O = 250mW$

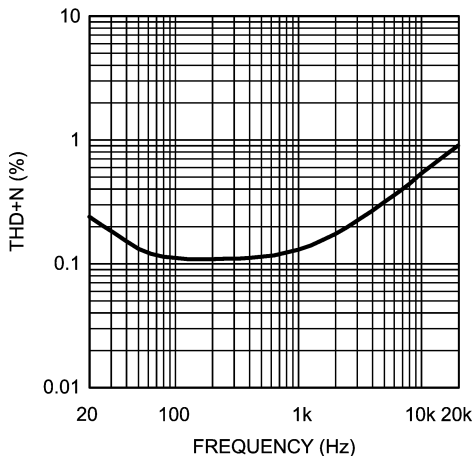

20074045

THD+N vs Frequency
 $V_{DD} = 2.6V$, $R_L = 4\Omega$, and $P_O = 150mW$

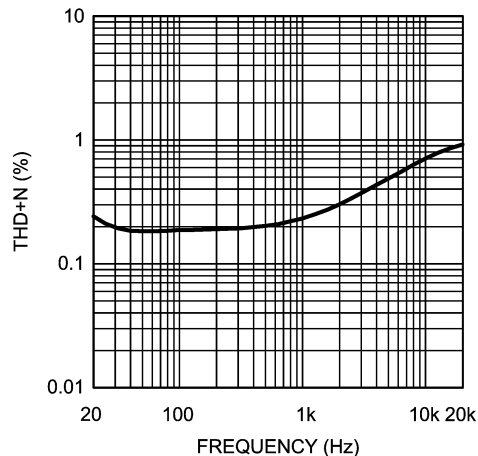

20074046

THD+N vs Frequency
 $V_{DD} = 2.6V$, $R_L = 8\Omega$, and $P_O = 150mW$

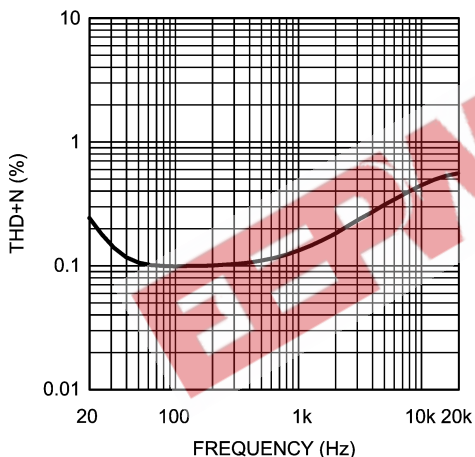

20074047

THD+N vs Output Power
 $V_{DD} = 5V$, $R_L = 8\Omega$, and $f = 1kHz$

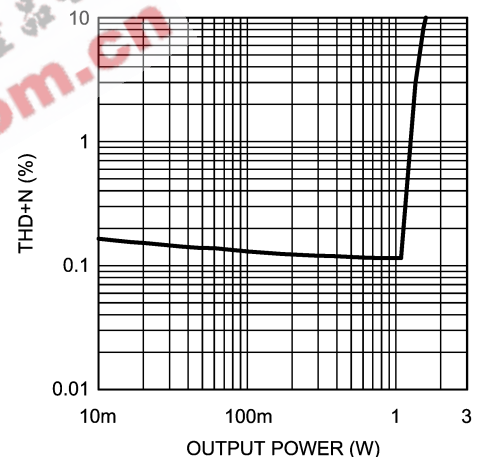

20074048

THD+N vs Output Power
 $V_{DD} = 3V$, $R_L = 4\Omega$, and $f = 1kHz$

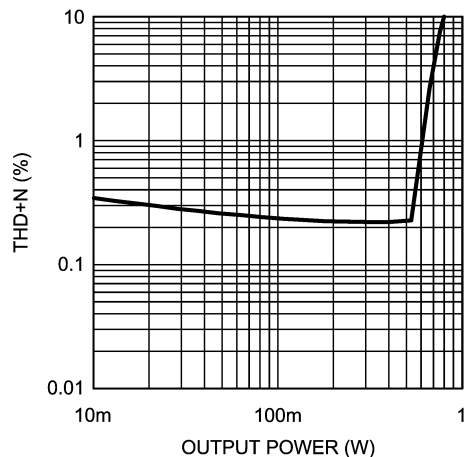

20074049

THD+N vs Output Power
 $V_{DD} = 3V$, $R_L = 8\Omega$, and $f = 1kHz$

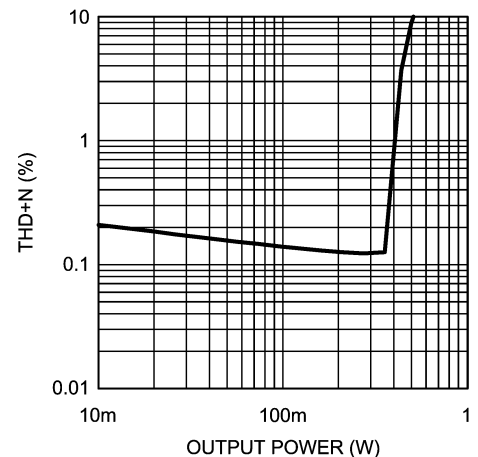

20074050

Typical Performance Characteristics (Continued)

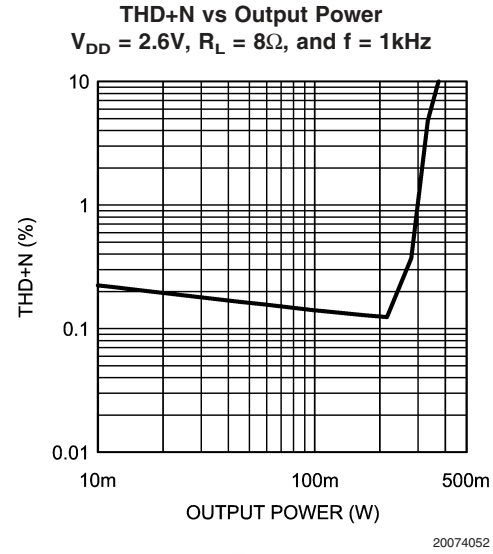
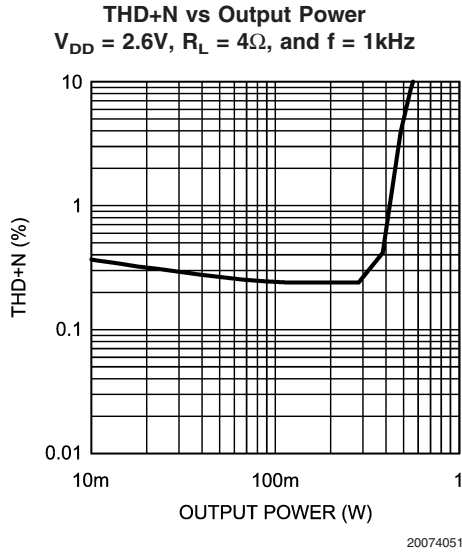

Power Supply Rejection Ratio (PSRR) vs Frequency
 $V_{DD} = 5V, R_L = 8\Omega, \text{ input } 10\Omega \text{ terminated}$

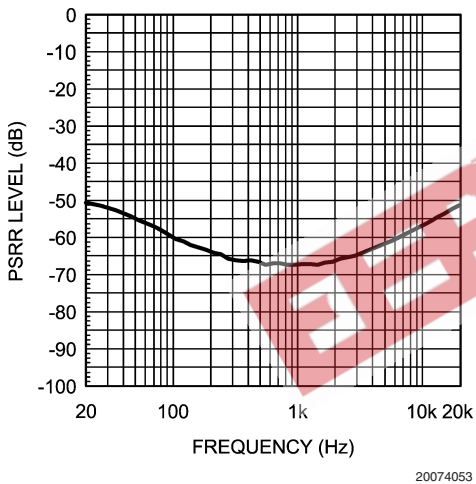

Power Supply Rejection Ratio (PSRR) vs Frequency
 $V_{DD} = 5V, R_L = 8\Omega, \text{ input floating}$

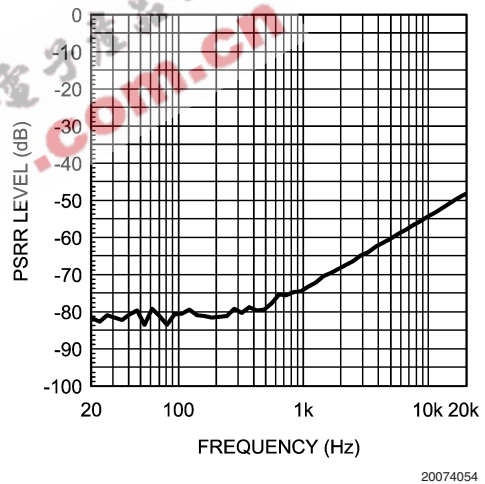

Power Supply Rejection Ratio (PSRR) vs Frequency
 $V_{DD} = 3V, R_L = 8\Omega, \text{ input } 10\Omega \text{ terminated}$

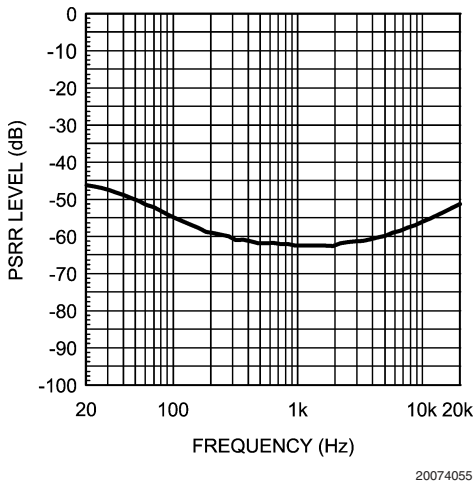

Power Supply Rejection Ratio (PSRR) vs Frequency
 $V_{DD} = 3V, R_L = 8\Omega, \text{ input floating}$

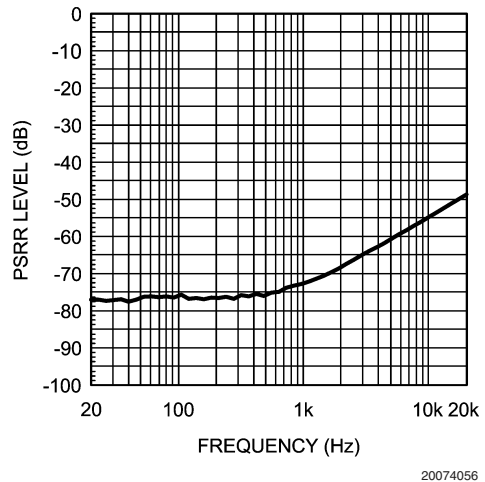

Typical Performance Characteristics (Continued)

Power Supply Rejection Ratio (PSRR) vs Frequency
 $V_{DD} = 2.6V$, $R_L = 8\Omega$, input 10Ω terminated

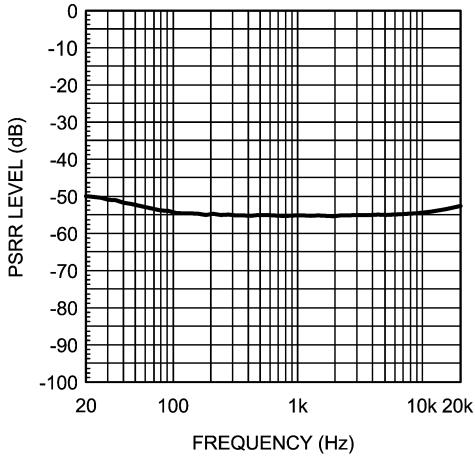

20074057

Power Supply Rejection Ratio (PSRR) vs Frequency
 $V_{DD} = 2.6V$, $R_L = 8\Omega$, Input Floating

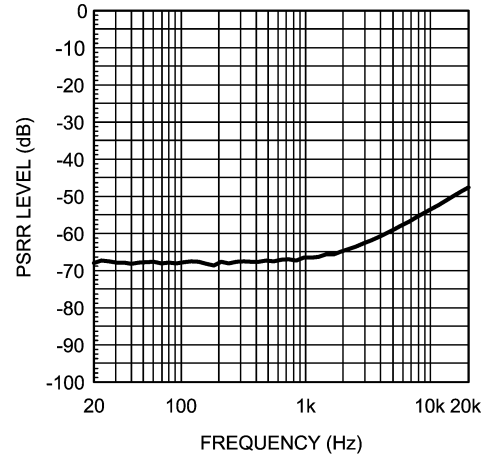

20074058

Open Loop Frequency Response, 5V

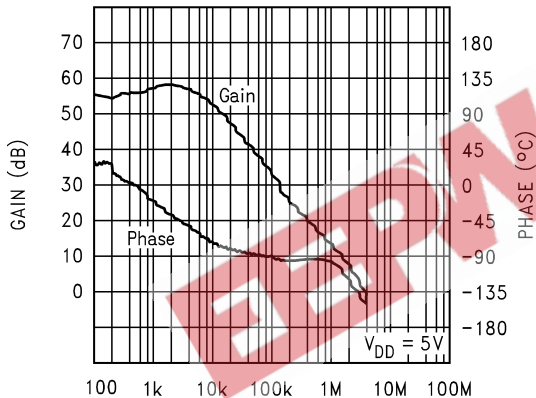

20074059

Noise Floor, 5V, 8Ω
 80kHz Bandwidth, Input to GND

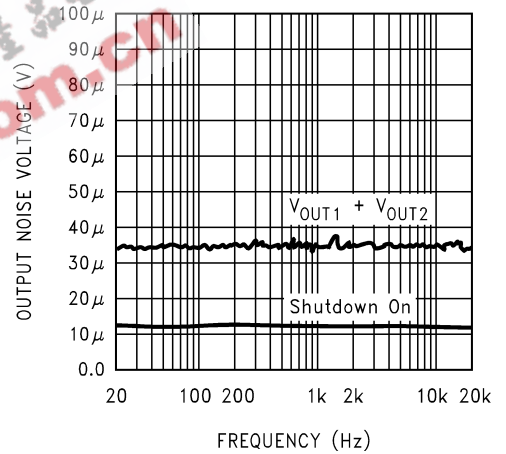

20074060

Power Dissipation vs Output Power, $V_{DD} = 5V$

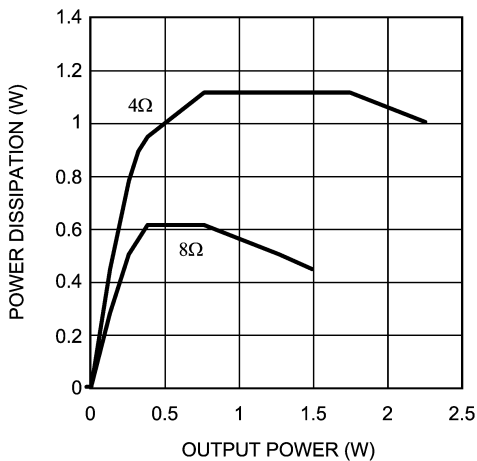

20074061

Power Dissipation vs Output Power, $V_{DD} = 3V$

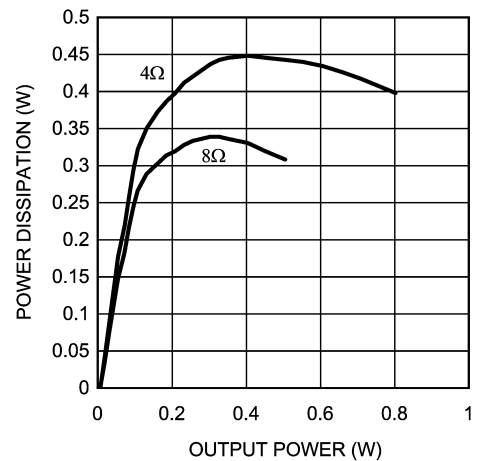

20074062

Typical Performance Characteristics (Continued)

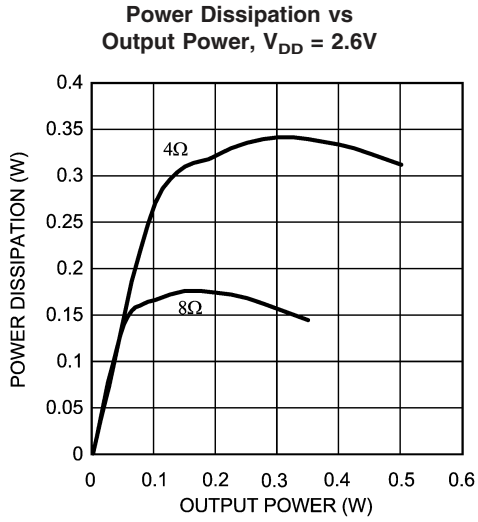

20074063

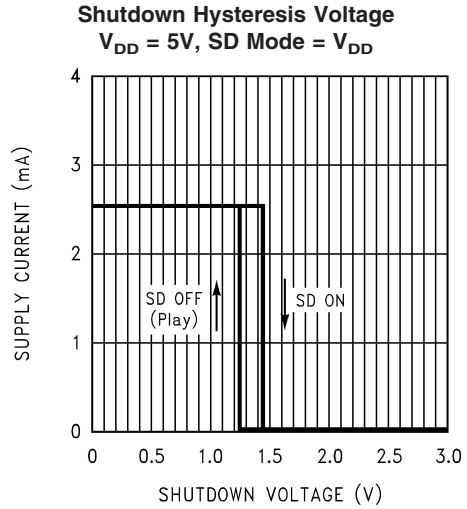

20074072

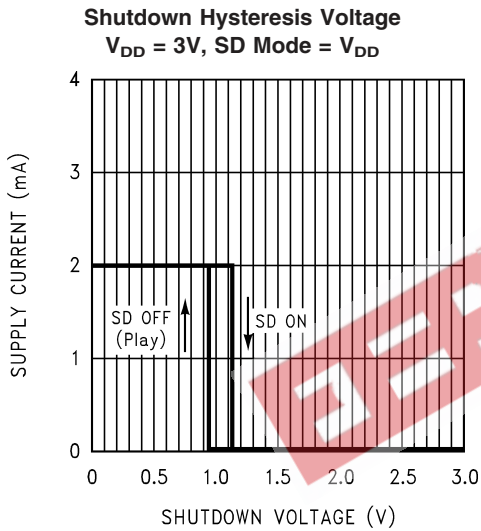

20074073

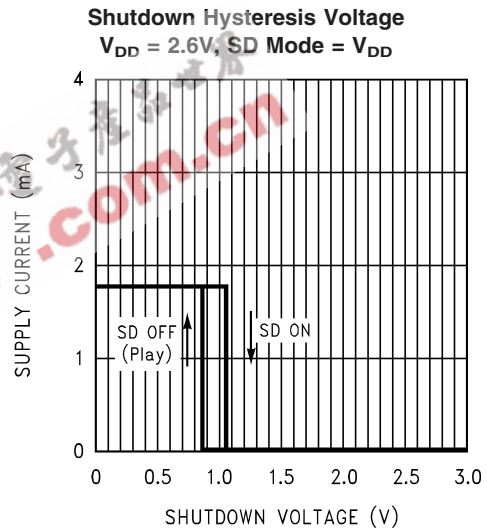

20074074

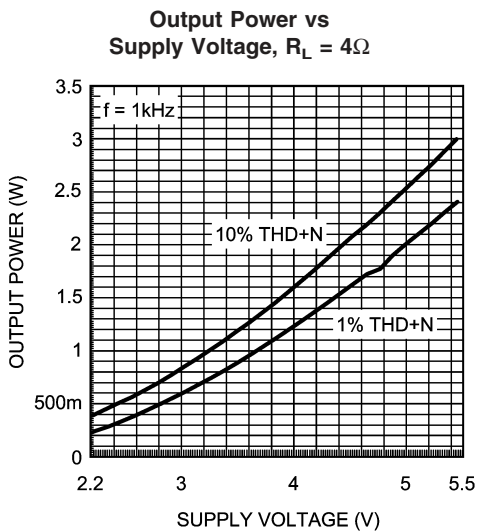

20074067

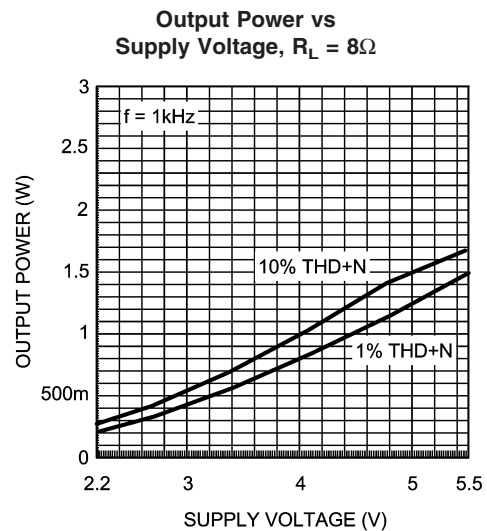

20074068

Typical Performance Characteristics (Continued)

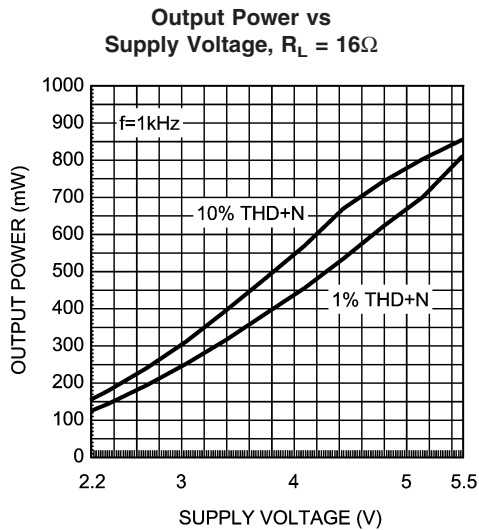

20074069

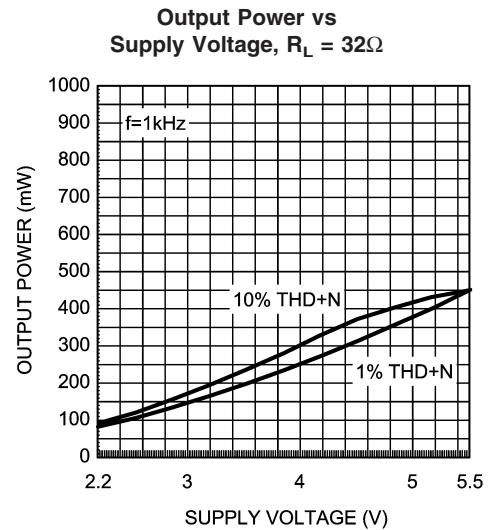

20074070

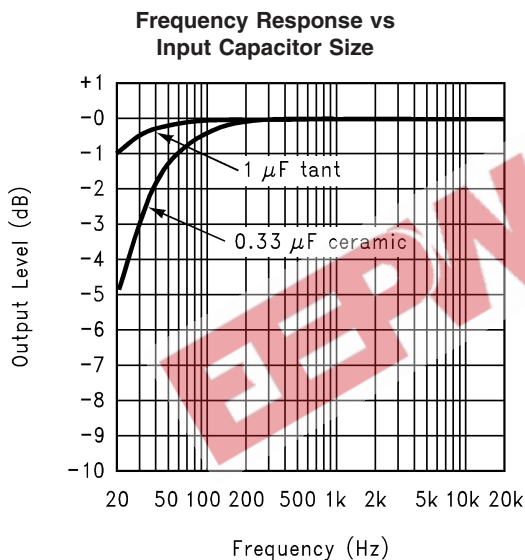

20074071

Application Information

EXPOSED-DAP PACKAGE PCB MOUNTING CONSIDERATION

The LM4991's exposed-DAP (die attach paddle) package (LD) provides a low thermal resistance between the die and the PCB to which the part is mounted and soldered. This allows rapid heat transfer from the die to the surrounding PCB copper traces, ground plane, and surrounding air. The result is a low voltage audio power amplifier that produces 2W at $\leq 1\%$ THD with a 4Ω load. This high power is achieved through careful consideration of necessary thermal design. Failing to optimize thermal design may compromise the LM4991's high power performance and activate unwanted, though necessary, thermal shutdown protection.

The LD package must have its DAP soldered to a copper pad on the PCB. The DAP's PCB copper pad is connected to a large plane of continuous unbroken copper. This plane forms a thermal mass, heat sink, and radiation area. Place the heat sink area on either outside plane in the case of a

two-sided PCB, or on an inner layer of a board with more than two layers. Connect the DAP copper pad to the inner layer or backside copper heat sink area with $4(2 \times 2)$ vias. The via diameter should be 0.012in-0.013in with a 1.27mm pitch. Ensure efficient thermal conductivity by plating through the vias.

Best thermal performance is achieved with the largest practical heat sink area. If the heatsink and amplifier share the same PCB layer, a nominal 2.5in^2 area is necessary for 5V operation with a 4Ω load. Heatsink areas not placed on the same PCB layer as the LM4991 should be 5in^2 (min) for the same supply voltage and load resistance. The last two area recommendations apply for 25°C ambient temperature. Increase the area to compensate for ambient temperatures above 25°C . The LM4991's power de-rating curve in the **Typical Performance Characteristics** shows the maximum power dissipation versus temperature. An example PCB layout for the LD package is shown in the **Demonstration Board Layout** section. Further detailed and specific information concerning PCB layout, fabrication, and mounting an

Application Information (Continued)

LD (LLP) package is available from National Semiconductor's Package Engineering Group under application note AN1187.

PCB LAYOUT AND SUPPLY REGULATION CONSIDERATIONS FOR DRIVING 3Ω AND 4Ω LOADS

Power dissipated by a load is a function of the voltage swing across the load and the load's impedance. As load impedance decreases, load dissipation becomes increasingly dependant on the interconnect (PCB trace and wire) resistance between the amplifier output pins and the load's connections. Residual trace resistance causes a voltage drop, which results in power dissipated in the trace and not in the load as desired. For example, 0.1Ω trace resistance reduces the output power dissipated by a 4Ω load from 2.0W to 1.95W. This problem of decreased load dissipation is exacerbated as load impedance decreases. Therefore, to maintain the highest load dissipation and widest output voltage swing, PCB traces that connect the output pins to a load must be as wide as possible.

Poor power supply regulation adversely affects maximum output power. A poorly regulated supply's output voltage decreases with increasing load current. Reduced supply voltage causes decreased headroom, output signal clipping, and reduced output power. Even with tightly regulated supplies, trace resistance creates the same effects as poor supply regulation. Therefore, making the power supply traces as wide as possible helps maintain full output voltage swing.

BRIDGE CONFIGURATION EXPLANATION

As shown in *Figure 1*, the LM4991 has two operational amplifiers internally, allowing for a few different amplifier configurations. The first amplifier's gain is externally configurable; the second amplifier is internally fixed in a unity-gain, inverting configuration. The closed-loop gain of the first amplifier is set by selecting the ratio of R_f to R_i , while the second amplifier's gain is fixed. *Figure 1* shows that the output of amplifier one serves as the input to amplifier two, which results in both amplifiers producing signals identical in magnitude, but 180° out of phase. Consequently, the differential gain for the IC is

$$A_{VD} = 2 * (R_f/R_i)$$

By driving the load differentially through outputs Vo1 and Vo2, an amplifier configuration commonly referred to as "bridged mode" is established. Bridged mode operation is different from the classical single-ended amplifier configuration where one side of its load is connected to ground.

A bridge amplifier design has a few distinct advantages over the single-ended configuration, as it provides differential drive to the load, thus doubling output swing for a specified supply voltage. Four times the output power is possible as compared to a single-ended amplifier under the same conditions. This increase in attainable output power assumes that the amplifier is not current limited or clipped. In order to choose an amplifier's closed-loop gain without causing excessive clipping, please refer to the **Audio Power Amplifier Design** section.

Another advantage of the differential bridge output is no net DC voltage across load. This results from biasing V_{O1} and V_{O2} at the same DC voltage, in this case $V_{DD}/2$. This eliminates the coupling capacitor that single supply, single-ended amplifiers require. Eliminating an output coupling capacitor in a single-ended configuration forces a single supply

amplifier's half-supply bias voltage across the load. The current flow created by the half-supply bias voltage increases internal IC power dissipation and may permanently damage loads such as speakers.

POWER DISSIPATION

Power dissipation is a major concern when designing a successful amplifier, whether the amplifier is bridged or single-ended. A direct consequence of the increased power delivered to the load by a bridge amplifier is an increase in internal power dissipation. Equation 1 states the maximum power dissipation point for a bridge amplifier operating at a given supply voltage and driving a specified output load.

$$P_{DMAX} = 4 * (V_{DD})^2 / (2\pi^2 R_L) \quad (1)$$

Since the LM4991 has two operational amplifiers in one package, the maximum internal power dissipation is 4 times that of a single-ended amplifier. Even with this substantial increase in power dissipation, the LM4991 does not require heatsinking under most operating conditions and output loading. From Equation 1, assuming a 5V power supply and an 8Ω load, the maximum power dissipation point is 625 mW. The maximum power dissipation point obtained from Equation 1 must not be greater than the power dissipation that results from Equation 2:

$$P_{DMAX} = (T_{JMAX} - T_A) / \theta_{JA} \quad (2)$$

For the SO package, $\theta_{JA} = 140^\circ\text{C}/\text{W}$. For the LD package soldered to a DAP pad that expands to a copper area of 1.0in² on a PCB, the LM4991's θ_{JA} is 56°C/W. $T_{JMAX} = 150^\circ\text{C}$ for the LM4991. The θ_{JA} can be decreased by using some form of heat sinking. The resultant θ_{JA} will be the summation of the θ_{JC} , θ_{CS} , and θ_{SA} . θ_{JC} is the junction to case of the package (or to the exposed DAP, as is the case with the LD package), θ_{CS} is the case to heat sink thermal resistance and θ_{SA} is the heat sink to ambient thermal resistance. By adding additional copper area around the LM4991, the θ_{JA} can be reduced from its free air value for the SO package. Increasing the copper area around the LD package from 1.0in² to 2.0in² area results in a θ_{JA} decrease to 46°C/W. Depending on the ambient temperature, T_A , and the θ_{JA} , Equation 2 can be used to find the maximum internal power dissipation supported by the IC packaging. If the result of Equation 1 is greater than that of Equation 2, then either the supply voltage must be decreased, the load impedance increased, the θ_{JA} decreased, or the ambient temperature reduced. For the typical application of a 5V power supply, with an 8Ω load, and no additional heatsinking, the maximum ambient temperature possible without violating the maximum junction temperature is approximately 61°C provided that device operation is around the maximum power dissipation point and assuming surface mount packaging. For the LD package in a typical application of a 5V power supply, with a 4Ω load, and 1.0in² copper area soldered to the exposed DAP pad, the maximum ambient temperature is approximately 77°C providing device operation is around the maximum power dissipation point. Internal power dissipation is a function of output power. If typical operation is not around the maximum power dissipation point, the ambient temperature can be increased. Refer to the **Typical Performance Characteristics** curves for power dissipation information for different output powers and output loading.

POWER SUPPLY BYPASSING

As with any amplifier, proper supply bypassing is critical for low noise performance and high power supply rejection. The capacitor location on both the bypass and power supply pins should be as close to the LM4991 as possible. The capacitor

Application Information (Continued)

connected between the bypass pin and ground improves the internal bias voltage's stability, producing improved PSRR. The improvements to PSRR increase as the bypass pin capacitor increases. Typical applications employ a 5V regulator with 10 μ F and a 0.1 μ F bypass capacitors which aid in supply stability. This does not eliminate the need for bypassing the supply nodes of the LM4991 with a 1 μ F tantalum capacitor. The selection of bypass capacitors, especially C_B , is dependent upon PSRR requirements, click and pop performance as explained in the section, **Proper Selection of External Components**, system cost, and size constraints.

SHUTDOWN FUNCTION

In order to reduce power consumption while not in use, the LM4991 contains a shutdown pin to externally turn off the amplifier's bias circuitry. This shutdown feature turns the amplifier off when a logic high is placed on the shutdown pin. The trigger point between a logic low and logic high level is typically half-supply. It is best to switch between ground and supply to provide maximum device performance. By switching the shutdown pin to V_{DD} , the LM4991 supply current draw will be minimized in idle mode. While the device will be disabled with shutdown pin voltages less than V_{DD} , the idle current may be greater than the typical value of 0.1 μ A. In either case, the shutdown pin should be tied to a definite voltage to avoid unwanted state changes.

In many applications, a microcontroller or microprocessor output is used to control the shutdown circuitry which provides a quick, smooth transition into shutdown. Another solution is to use a single-pole, single-throw switch in conjunction with an external pull-up resistor. When the switch is closed, the shutdown pin is connected to ground and enables the amplifier. If the switch is open, then the external pull-up resistor will disable the LM4991. This scheme guarantees that the shutdown pin will not float thus preventing unwanted state changes.

PROPER SELECTION OF EXTERNAL COMPONENTS

Proper selection of external components in applications using integrated power amplifiers is critical to optimize device and system performance. While the LM4991 is tolerant of external component combinations, consideration to component values must be used to maximize overall system quality.

The LM4991 is unity-gain stable which gives a designer maximum system flexibility. The LM4991 should be used in low gain configurations to minimize THD+N values, and maximize the signal to noise ratio. Low gain configurations require large input signals to obtain a given output power. Input signals equal to or greater than 1 Vrms are available from sources such as audio codecs. Please refer to the section, **Audio Power Amplifier Design**, for a more complete explanation of proper gain selection.

Besides gain, one of the major considerations is the closed-loop bandwidth of the amplifier. To a large extent, the bandwidth is dictated by the choice of external components shown in *Figure 1*. The input coupling capacitor, C_i , forms a first order high pass filter which limits low frequency response. This value should be chosen based on needed frequency response for a few distinct reasons.

Selection Of Input Capacitor Size

Large input capacitors are both expensive and space hungry for portable designs. Clearly, a certain sized capacitor is needed to couple in low frequencies without severe attenuation. But in many cases the speakers used in portable systems, whether internal or external, have little ability to reproduce signals below 100Hz to 150Hz. Thus, using a large input capacitor may not increase actual system performance.

In addition to system cost and size, click and pop performance is effected by the size of the input coupling capacitor, C_i . A larger input coupling capacitor requires more charge to reach its quiescent DC voltage (nominally 1/2 V_{DD}). This charge comes from the output via the feedback and is apt to create pops upon device enable. Thus, by minimizing the capacitor size based on necessary low frequency response, turn-on pops can be minimized.

Besides minimizing the input capacitor size, careful consideration should be paid to the bypass capacitor value. Bypass capacitor, C_B , is the most critical component to minimize turn-on pops since it determines how fast the LM4991 turns on. The slower the LM4991's outputs ramp to their quiescent DC voltage (nominally 1/2 V_{DD}), the smaller the turn-on pop. Choosing C_B equal to 1.0 μ F along with a small value of C_i (in the range of 0.1 μ F to 0.39 μ F), should produce a virtually clickless and popless shutdown function. While the device will function properly, (no oscillations or motorboating), with C_B equal to 0.1 μ F, the device will be much more susceptible to turn-on clicks and pops. Thus, a value of C_B equal to 1.0 μ F is recommended in all but the most cost sensitive designs.

AUDIO POWER AMPLIFIER DESIGN

Design a 1W/8 Ω Audio Amplifier

Given:

Power Output	1 Wrms
Load Impedance	8 Ω
Input Level	1 Vrms
Input Impedance	20 k Ω
Bandwidth	100 Hz–20 kHz \pm 0.25 dB

A designer must first determine the minimum supply rail to obtain the specified output power. By extrapolating from the Output Power vs Supply Voltage graphs in the **Typical Performance Characteristics** section, the supply rail can be easily found. A second way to determine the minimum supply rail is to calculate the required V_{opeak} using Equation 3 and add the output voltage. Using this method, the minimum supply voltage would be ($V_{\text{opeak}} + (V_{\text{ODTOP}} + V_{\text{ODBOT}})$), where V_{ODBOT} and V_{ODTOP} are extrapolated from the Dropout Voltage vs Supply Voltage curve in the **Typical Performance Characteristics** section.

$$V_{\text{opeak}} = \sqrt{(2R_L P_O)} \quad (3)$$

Using the Output Power vs Supply Voltage graph for an 8 Ω load, the minimum supply rail is 4.6V. But since 5V is a standard voltage in most applications, it is chosen for the supply rail. Extra supply voltage creates headroom that allows the LM4991 to reproduce peaks in excess of 1W without producing audible distortion. At this time, the designer

Application Information (Continued)

must make sure that the power supply choice along with the output impedance does not violate the conditions explained in the **Power Dissipation** section.

Once the power dissipation equations have been addressed, the required differential gain can be determined from Equation 4.

$$A_{VD} \geq \sqrt{(P_{O}R_L)/(V_{IN})} = V_{or\text{rms}}/V_{in\text{rms}} \quad (4)$$

$$R_f/R_i = A_{VD}/2 \quad (5)$$

From Equation 4, the minimum A_{VD} is 2.83; use $A_{VD} = 3$.

Since the desired input impedance was $20\text{k}\Omega$, and with a A_{VD} impedance of 2, a ratio of 1.5:1 of R_f to R_i results in an allocation of $R_i = 20\text{k}\Omega$ and $R_f = 30\text{k}\Omega$. The final design step is to address the bandwidth requirements which must be

stated as a pair of -3dB frequency points. Five times away from a -3dB point is 0.17dB down from passband response which is better than the required $\pm 0.25\text{dB}$ specified.

$$f_L = 100\text{Hz}/5 = 20\text{Hz}$$

$$f_H = 20\text{kHz} * 5 = 100\text{kHz}$$

As stated in the **External Components** section, R_i in conjunction with C_i create a highpass filter.

$$C_i \geq 1/(2\pi * 20\text{k}\Omega * 20\text{Hz}) = 0.397\mu\text{F}; \text{ use } 0.39\mu\text{F}$$

The high frequency pole is determined by the product of the desired frequency pole, f_H , and the differential gain, A_{VD} . With a $A_{VD} = 3$ and $f_H = 100\text{kHz}$, the resulting $\text{GBWP} = 150\text{kHz}$ which is much smaller than the LM4991 GBWP of 4MHz . This figure displays that if a designer has a need to design an amplifier with a higher differential gain, the LM4991 can still be used without running into bandwidth limitations.

EEPW 电子产品世界
.com.cn

Physical Dimensions inches (millimeters) unless otherwise noted

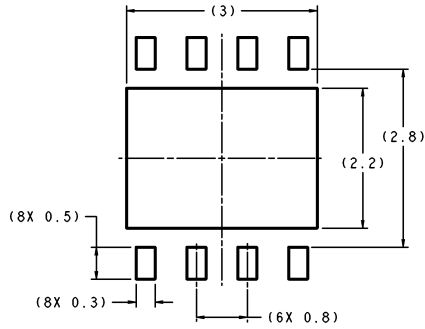

DIMENSIONS ARE IN MILLIMETERS

RECOMMENDED LAND PATTERN
1:1 RATION WITH PKG SOLDER PADS

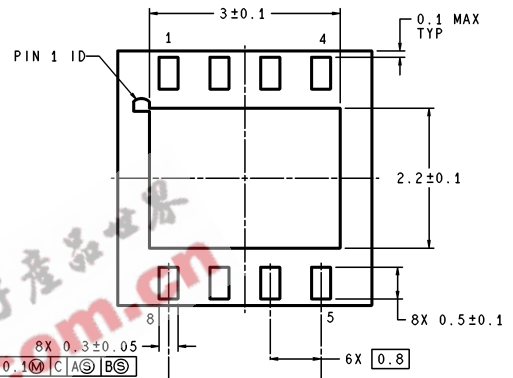
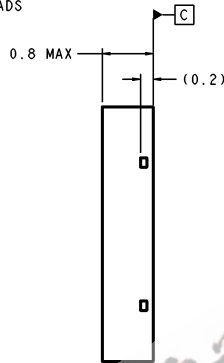
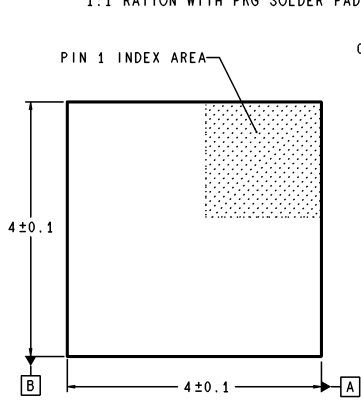

LDC08A (Rev A)

Order Number LM4991LD
See NS Package Number LDC08A

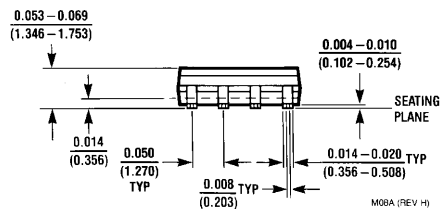
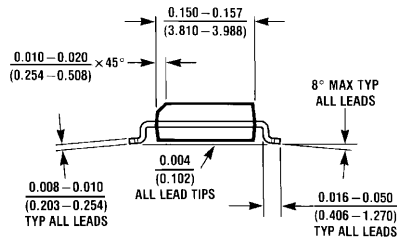
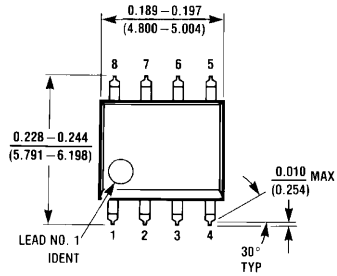

M08A (REV H)

Order Number LM4991MA
NS Package Number M08A

Notes

EEPW 电子產品世界
.com.cn

LIFE SUPPORT POLICY

NATIONAL'S PRODUCTS ARE NOT AUTHORIZED FOR USE AS CRITICAL COMPONENTS IN LIFE SUPPORT DEVICES OR SYSTEMS WITHOUT THE EXPRESS WRITTEN APPROVAL OF THE PRESIDENT AND GENERAL COUNSEL OF NATIONAL SEMICONDUCTOR CORPORATION. As used herein:

1. Life support devices or systems are devices or systems which, (a) are intended for surgical implant into the body, or (b) support or sustain life, and whose failure to perform when properly used in accordance with instructions for use provided in the labeling, can be reasonably expected to result in a significant injury to the user.
2. A critical component is any component of a life support device or system whose failure to perform can be reasonably expected to cause the failure of the life support device or system, or to affect its safety or effectiveness.



National Semiconductor
Americas Customer
Support Center
Email: new.feedback@nsc.com
Tel: 1-800-272-9959

www.national.com

National Semiconductor
Europe Customer Support Center
Fax: +49 (0) 180-530 85 86
Email: europe.support@nsc.com
Deutsch Tel: +49 (0) 69 9508 6208
English Tel: +44 (0) 870 24 0 2171
Français Tel: +33 (0) 1 41 91 8790

National Semiconductor
Asia Pacific Customer
Support Center
Email: ap.support@nsc.com

National Semiconductor
Japan Customer Support Center
Fax: 81-3-5639-7507
Email: jpn.feedback@nsc.com
Tel: 81-3-5639-7560