

LM2901, LM339/LM339A, LM3302 LM239/LM239A Quad Comparator

Features

- Single or Dual Supply Operation
- Wide Range of Supply Voltage
LM2901, LM339/LM339A, LM239/LM239A: 2 ~ 36V
(or $\pm 1 \sim \pm 18V$)
LM3302: 2 ~ 28V (or $\pm 1 \sim \pm 14V$)
- Low Supply Current Drain 800 μA Typ.
- Open Collector Outputs for Wired and Connectors
- Low Input Bias Current 25nA Typ.
- Low Input Offset Current $\pm 2.3nA$ Typ.
- Low Input Offset Voltage $\pm 1.4mV$ Typ.
- Input Common Mode Voltage Range Includes Ground.
- Low Output Saturation Voltage
- Output Compatible With TTL, DTL and MOS Logic System

Description

The LM2901, LM339/LM339A, LM239/LM239A, LM3302 consist of four independent voltage comparators designed to operate from single power supply over a wide voltage range.



Internal Block Diagram

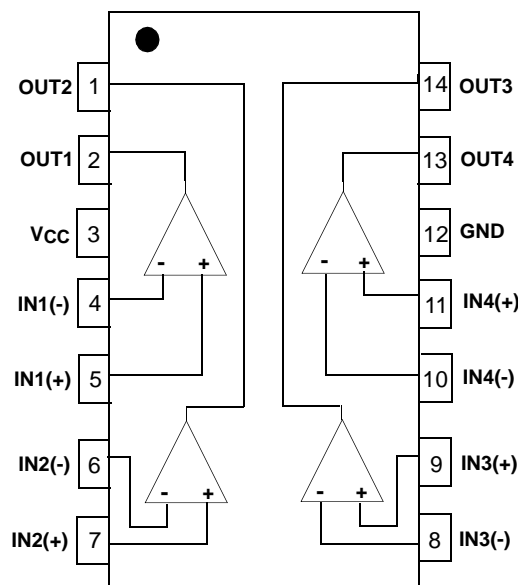

Schematic Diagram

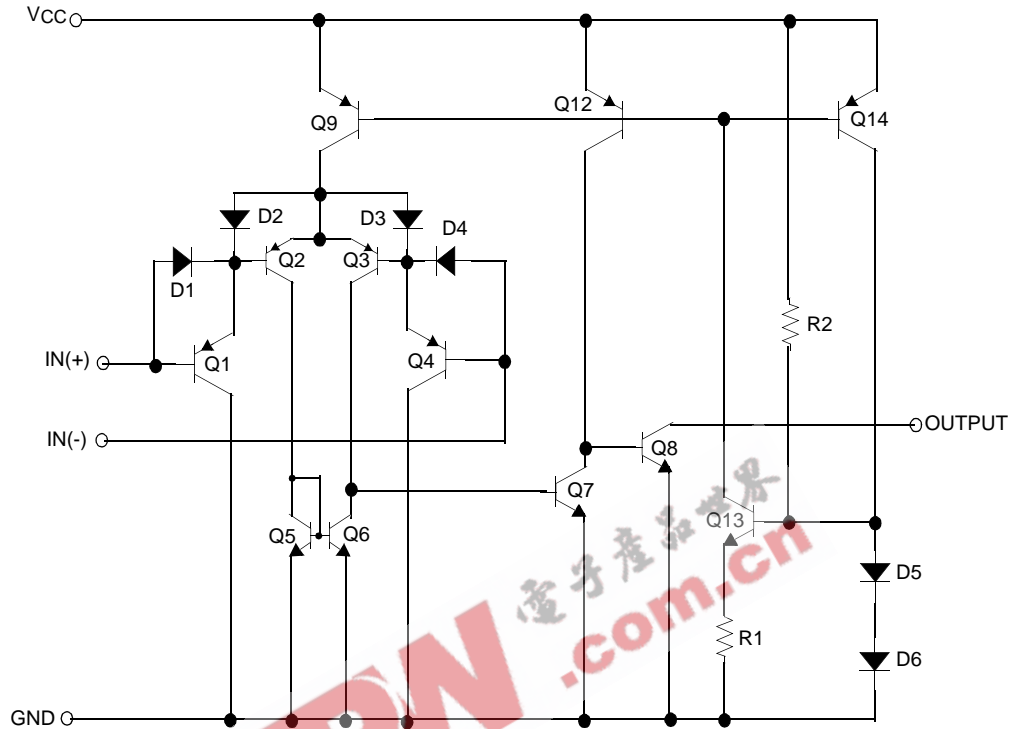

Absolute Maximum Ratings

Parameter	Symbol	Value	Unit
Supply Voltage	VCC	±18 or 36	V
Supply Voltage only LM3302	VCC	±14 or 28	V
Differential Input Voltage	V _{I(DIFF)}	36	V
Differential Input Voltage Only LM3302	V _{I(DIFF)}	28	V
Input Voltage	V _I	-0.3 to +36	V
Input Voltage Only LM3302	V _I	-0.3 to +28	V
Output Short Circuit to GND	-	Continuous	-
Power Dissipation	P _D	570	mW
Operating Temperature LM339/LM339A LM2901/LM3302 LM239/LM239A	T _{OPR}	0 ~ +70 -40 ~ +85 -25 ~ +85	°C
Storage Temperature	T _{STG}	-65 ~ +150	°C

Electrical Characteristics

($V_{CC} = 5V$, $T_A = 25^\circ C$, unless otherwise specified)

Parameter	Symbol	Conditions	LM239A/LM339A			LM239/LM339			Unit
			Min.	Typ.	Max.	Min.	Typ.	Max.	
Input Offset Voltage	V_{IO}	$V_{O(P)} = 1.4V$, $R_S = 0\Omega$	-	1	2	-	1.4	5	mV
		Note1	-	-	4.0	-	-	9.0	
Input Offset Current	I_{IO}	$I_{IN(+)} - I_{IN(-)}$, $V_{CM} = 0V$	-	2.3	50	-	2.3	50	nA
		Note1	-	-	150	-	-	150	
Input Bias Current	I_{BIAS}	$V_{CM} = 0V$	-	57	250	-	57	250	nA
		Note1	-	-	400	-	-	400	
Input Common Mode Voltage Range	$V_{I(R)}$	$V_{CC} = 30V$	0	-	$V_{CC}-1.5$	0	-	$V_{CC}-1.5$	V
		Note1	0	-	$V_{CC}-2$	0	-	$V_{CC}-2$	
Supply Current	I_{CC}	$V_{CC} = 5V$, $R_L = \infty$	-	1.1	2.0	-	1.1	2.0	mA
Voltage Gain	G_V	$V_{CC} = 15V$, $R_L \geq 15k\Omega$ (for large swing)	50	200	-	50	200	-	V/mV
Large Signal Response Time	T_{LRES}	$V_I = \text{TTL Logic Swing}$ $V_{REF} = 1.4V$, $V_{RL} = 5V$, $R_L = 5.1k\Omega$ (Note2)	-	300	-	-	300	-	ns
Response Time	T_{RES}	$V_{RL} = 5V$, $R_L = 5.1k\Omega$ (Note2)	-	1.3	-	-	1.3	-	μs
Output Sink Current	I_{SINK}	$V_{I(-)} \geq 1V$, $V_{I(+)} = 0V$, $V_{O(P)} \leq 1.5V$	6	18	-	6	18	-	mA
Output Saturation Voltage	V_{SAT}	$V_{I(-)} \geq 1V$, $V_{I(+)} = 0V$ $I_{SINK} = 4mA$	-	140	400	-	140	400	mV
		Note1	-	-	700	-	-	700	
Output Leakage Current	$I_{O(LKG)}$	$V_{I(-)} = 0V$	-	0.1	-	-	0.1	-	nA
		$V_{I(+)} = 1V$	-	-	1.0	-	-	1.0	μA
Differential Voltage	$V_{I(DIFF)}$	Note1	-	-	36	-	-	36	V

Note:

- LM339/LM339A : $0 \leq T_A \leq +70^\circ C$
LM2901/LM3302 : $-40 \leq T_A \leq +85^\circ C$
LM239/LM239A : $-25 \leq T_A \leq +85^\circ C$
- These parameters, although guaranteed, are not 100% tested in production.

Electrical Characteristics (Continued)(V_{CC} = 5V, T_A = 25°C, unless otherwise specified)

Parameter	Symbol	Conditions	LM2901			LM3302			Unit
			Min.	Typ.	Max.	Min.	Typ.	Max.	
Input Offset Voltage	V _{IO}	V _{O(P)} = 1.4V, R _S = 0Ω	-	2	7	-	2	20	mV
		Note1	-	9	15	-	-	40	
Input Offset Current	I _{IO}		-	2.3	50	-	3	100	nA
		Note1	-	50	200	-	-	300	
Input Bias Current	I _{BIAS}		-	57	250	-	57	250	nA
		Note1	-	200	500	-	-	1000	
Input Common Mode Voltage Range	V _{I(R)}	LM2901, V _{CC} = 30V LM3302, V _{CC} = 28V	0	-	V _{CC} - 1.5	0	-	V _{CC} - 1.5	V
		Note1	0	-	V _{CC} - 2	0	-	V _{CC} - 2	
Supply Current	I _{CC}	R _L = ∞, V _{CC} = 5V	-	1.1	2.0	-	1.1	2.0	mA
		R _L = ∞, V _{CC} = 30V (LM3302, V _{CC} = 28V)	-	1.6	2.5	-	1.6	2.5	
Voltage Gain	G _V	V _{CC} = 15V, R _L ≥ 15kΩ (for large swing)	25	100	-	2	30	-	V/ mV
Large Signal Response Time	T _{LRES}	V _I = TTL Logic Swing V _{REF} = 1.4V, V _{RL} = 5V, R _L = 5.1kΩ (Note2)	-	300	-	-	300	-	ns
Response Time	T _{RES}	V _{RL} = 5V, R _L = 5.1kΩ (Note2)	-	1.3	-	-	1.3	-	μs
Output Sink Current	I _{SINK}	V _{I(-)} ≥ 1V, V _{I(+)} = 0V, V _{O(P)} ≤ 1.5V	6	18	-	6	18	-	mA
Output Saturation Voltage	V _{SAT}	V _{I(-)} ≥ 1V, V _{I(+)} = 0V	-	140	400	-	140	400	mV
		I _{SINK} = 4mA	-	-	700	-	-	700	
Output Leakage Current	I _{O(LKG)}	V _{I(-)} = 0V	-	0.1	-	-	0.1	-	nA
		V _{I(+)} = 1V	-	-	1.0	-	-	1.0	μA
Differential Voltage	V _{I(DIFF)}	Note1	-	-	36	-	-	28	V

Note:

- LM339/LM339A : 0 ≤ T_A ≤ +70°C
LM2901/LM3302 : -40 ≤ T_A ≤ +85°C
LM239/LM239A : -25 ≤ T_A ≤ +85°C
- These parameters, although guaranteed, are not 100% tested in production.

Typical Performance Characteristics

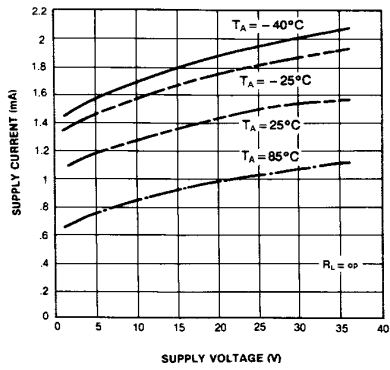

Figure 1. Supply Current vs Supply Voltage

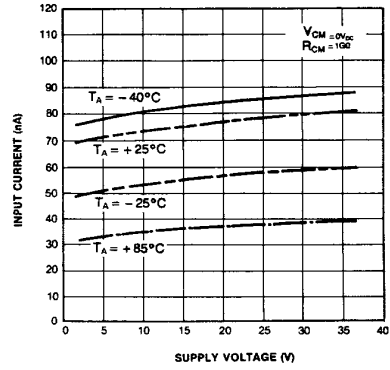

Figure 2. Input Current vs Supply Voltage

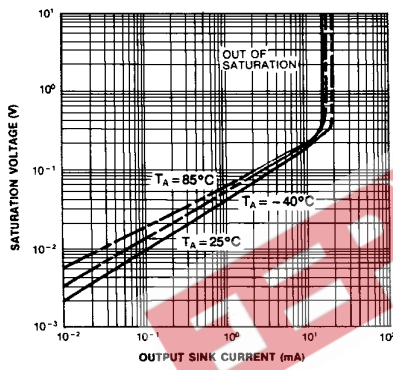

Figure 3. Output Saturation Voltage vs Sink Current

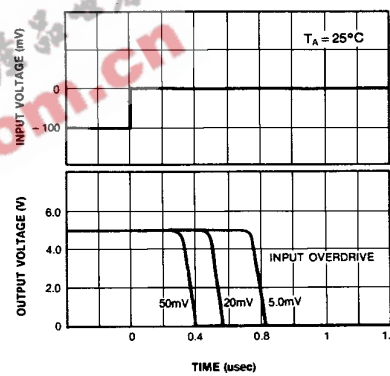

Figure 4. Response Time for Various Input Overdrive-Negative Transition

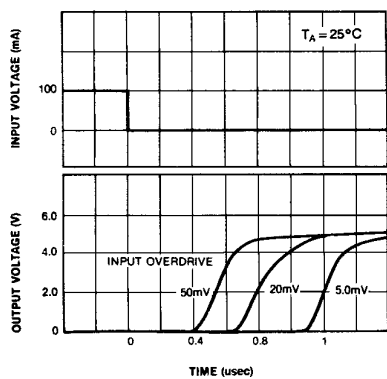

Figure 5. Response Time for Various Input Overdrive-Positive Transition

Mechanical Dimensions

Package

Dimensions in millimeters

14-DIP

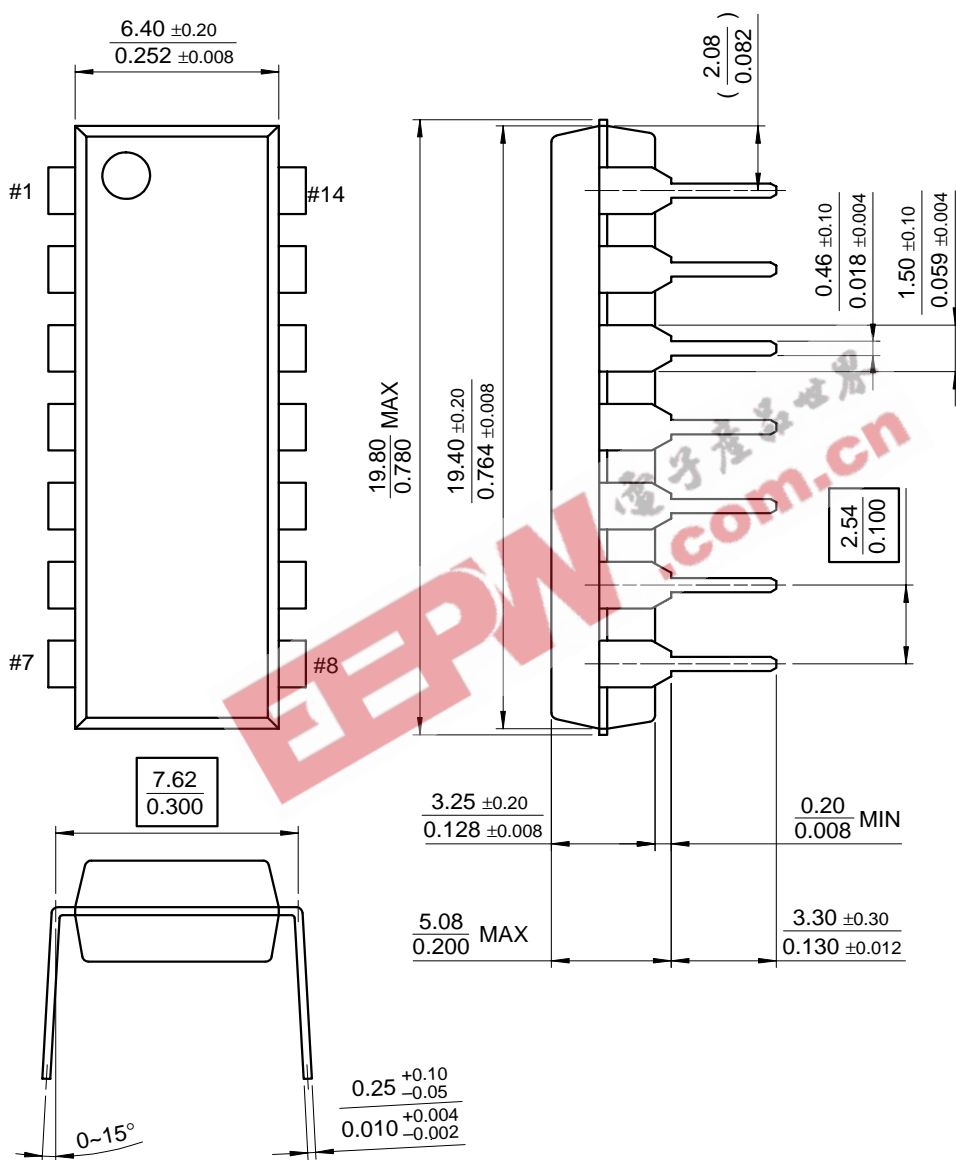

Mechanical Dimensions (Continued)

Package

Dimensions in millimeters

14-SOP

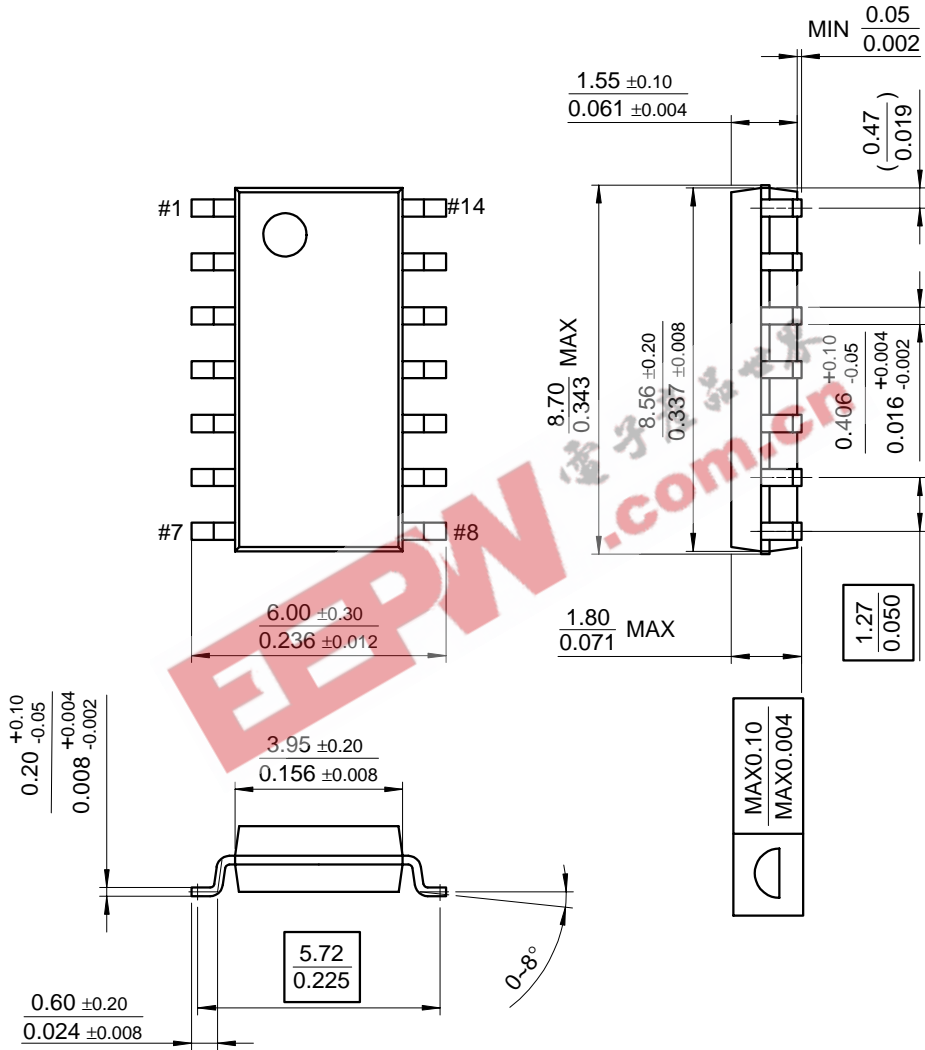

Ordering Information

Product Number	Package	Operating Temperature
LM339N	14-DIP	0 ~ +70°C
LM339AN		
LM339M	14-SOP	
LM339AM		
LM2901N	14-DIP	-40 ~ +85°C
LM2901M	14-SOP	
LM3302N	14-DIP	
LM3302M	14-SOP	
LM239N	14-DIP	-25 ~ +85°C
LM239AN		
LM239M	14-SOP	
LM239AM		



 EEPW.com.cn 电子產品世界

DISCLAIMER

FAIRCHILD SEMICONDUCTOR RESERVES THE RIGHT TO MAKE CHANGES WITHOUT FURTHER NOTICE TO ANY PRODUCTS HEREIN TO IMPROVE RELIABILITY, FUNCTION OR DESIGN. FAIRCHILD DOES NOT ASSUME ANY LIABILITY ARISING OUT OF THE APPLICATION OR USE OF ANY PRODUCT OR CIRCUIT DESCRIBED HEREIN; NEITHER DOES IT CONVEY ANY LICENSE UNDER ITS PATENT RIGHTS, NOR THE RIGHTS OF OTHERS.

LIFE SUPPORT POLICY

FAIRCHILD'S PRODUCTS ARE NOT AUTHORIZED FOR USE AS CRITICAL COMPONENTS IN LIFE SUPPORT DEVICES OR SYSTEMS WITHOUT THE EXPRESS WRITTEN APPROVAL OF THE PRESIDENT OF FAIRCHILD SEMICONDUCTOR CORPORATION. As used herein:

1. Life support devices or systems are devices or systems which, (a) are intended for surgical implant into the body, or (b) support or sustain life, and (c) whose failure to perform when properly used in accordance with instructions for use provided in the labeling, can be reasonably expected to result in a significant injury of the user.
2. A critical component in any component of a life support device or system whose failure to perform can be reasonably expected to cause the failure of the life support device or system, or to affect its safety or effectiveness.