

## FEATURES

- Fixed Output Voltages of 2.048 V, 2.5 V, 3 V, 4.096 V, 5 V, 8.192 V, and 10 V
- Tight Output Tolerances and Low Temperature Coefficient
  - Max 0.1%, 100 ppm/°C – A Grade
  - Max 0.2%, 100 ppm/°C – B Grade
  - Max 0.5%, 100 ppm/°C – C Grade
  - Max 1.0%, 150 ppm/°C – D Grade
- Low Output Noise...35  $\mu\text{V}_{\text{RMS}}$  Typ
- Wide Operating Current Range...45  $\mu\text{A}$  Typ to 15 mA
- Stable With All Capacitive Loads; No Output Capacitor Required
- Available in Extended Temperature Range...–40°C to 125°C

## APPLICATIONS

- Data-Acquisition Systems
- Power Supplies and Power-Supply Monitors
- Instrumentation and Test Equipment
- Process Controls
- Precision Audio
- Automotive Electronics
- Energy Management
- Battery-Powered Equipment

## DESCRIPTION/ORDERING INFORMATION

The LM4040 series of shunt voltage references are versatile, easy-to-use references that cater to a vast array of applications. The 2-pin fixed-output device requires no external capacitors for operation and is stable with all capacitive loads. Additionally, the reference offers low dynamic impedance, low noise, and low temperature coefficient to ensure a stable output voltage over a wide range of operating currents and temperatures. The LM4040 uses fuse and Zener-zap reverse breakdown voltage trim during wafer sort to offer four output voltage tolerances, ranging from 0.1% (max) for the A grade to 1% (max) for the D grade. Thus, a great deal of flexibility is offered to designers in choosing the best cost-to-performance ratio for their applications.

Packaged in space-saving SC-70 and SOT-23-3 packages and requiring a minimum current of 45  $\mu\text{A}$  (typ), the LM4040 also is ideal for portable applications. The LM4040xl is characterized for operation over an ambient temperature range of –40°C to 85°C. The LM4040xQ is characterized for operation over an ambient temperature range of –40°C to 125°C.

DBZ (SOT-23) PACKAGE  
(TOP VIEW)

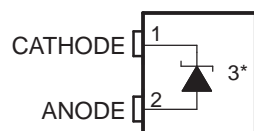

\* Pin 3 is attached to substrate and must be connected to ANODE or left open.

DCK (SC-70) PACKAGE  
(TOP VIEW)

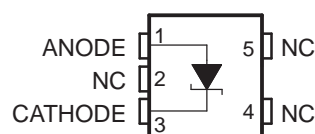

NC – No internal connection

LP (TO-92/TO-226) PACKAGE  
(TOP VIEW)



NC – No internal connection



Please be aware that an important notice concerning availability, standard warranty, and use in critical applications of Texas Instruments semiconductor products and disclaimers thereto appears at the end of this data sheet.

# LM4040 PRECISION MICROPOWER SHUNT VOLTAGE REFERENCE



SLOS456J – JANUARY 2005 – REVISED SEPTEMBER 2006

## ORDERING INFORMATION

$T_A$	DEVICE GRADE	$V_{KA}$	PACKAGE <sup>(1)</sup>		ORDERABLE PART NUMBER	TOP-SIDE MARKING <sup>(2)</sup>
-40°C to 85°C	A grade: 0.1% initial accuracy and 100 ppm/°C temperature coefficient	2.048 V	SC-70 (DCK)	Reel of 3000	LM4040A20IDCKR	MS_
				Reel of 3000	LM4040A20IDBZR	4MC_
			SOT-23-3 (DBZ)	Reel of 250	LM4040A20IDBZT	
				TO-92/TO-226 (LP)	Bulk of 1000	LM4040A20ILP
			Reel of 2000		LM4040A20ILPR	
			2.5 V	SC-70 (DCK)	Reel of 3000	LM4040A25IDCKR
		Reel of 3000			LM4040A25IDBZR	4NG_
		SOT-23-3 (DBZ)		Reel of 250	LM4040A25IDBZT	
				TO-92/TO-226 (LP)	Bulk of 1000	LM4040A25ILP
		Reel of 2000			LM4040A25ILPR	
		3 V		SC-70 (DCK)	Reel of 3000	LM4040A30IDCKR
			Reel of 3000		LM4040A30IDBZR	4M6_
			SOT-23-3 (DBZ)	Reel of 250	LM4040A30IDBZT	
				TO-92/TO-226 (LP)	Bulk of 1000	LM4040A30ILP
			Reel of 2000		LM4040A30ILPR	
			4.096 V	SC-70 (DCK)	Reel of 3000	LM4040A41IDCKR
		Reel of 3000			LM4040A41IDBZR	4M2_
		SOT-23-3 (DBZ)		Reel of 250	LM4040A41IDBZT	
				TO-92/TO-226 (LP)	Bulk of 1000	LM4040A41ILP
		Reel of 2000			LM4040A41ILPR	
		5 V		SC-70 (DCK)	Reel of 3000	LM4040A50IDCKR
			Reel of 3000		LM4040A50IDBZR	4NA_
			SOT-23-3 (DBZ)	Reel of 250	LM4040A50IDBZT	
				TO-92/TO-226 (LP)	Bulk of 1000	LM4040A50ILP
Reel of 2000	LM4040A50ILPR					
8.192 V	SC-70 (DCK)		Reel of 3000	LM4040A82IDCKR	PD_	
		Reel of 3000	LM4040A82IDBZR	4NL_		
	SOT-23-3 (DBZ)	Reel of 250	LM4040A82IDBZT			
		TO-92/TO-226 (LP)	Bulk of 1000	LM4040A82ILP	PREVIEW	
	Reel of 2000		LM4040A82ILPR			
	10 V	SC-70 (DCK)	Reel of 3000	LM4040A10IDCKR	PH_	
Reel of 3000			LM4040A10IDBZR	4NQ_		
SOT-23-3 (DBZ)		Reel of 250	LM4040A10IDBZT			
		TO-92/TO-226 (LP)	Bulk of 1000	LM4040A10ILP	PREVIEW	
Reel of 2000			LM4040A10ILPR			

(1) Package drawings, standard packing quantities, thermal data, symbolization, and PCB design guidelines are available at [www.ti.com/sc/package](http://www.ti.com/sc/package).

(2) DBZ/DCK: The actual top-side marking has one additional character that designates the assembly/test site.

**ORDERING INFORMATION (continued)**

$T_A$	DEVICE GRADE	$V_{KA}$	PACKAGE <sup>(1)</sup>		ORDERABLE PART NUMBER	TOP-SIDE MARKING <sup>(2)</sup>
-40°C to 85°C	B grade: 0.2% initial accuracy and 100 ppm/°C temperature coefficient	2.048 V	SC-70 (DCK)	Reel of 3000	LM4040B20IDCKR	MT_
			SOT-23-3 (DBZ)	Reel of 3000	LM4040B20IDBZR	4MD_
				Reel of 250	LM4040B20IDBZT	
			TO-92/TO-226 (LP)	Bulk of 1000	LM4040B20ILP	PREVIEW
				Reel of 2000	LM4040B20ILPR	
			2.5 V	SC-70 (DCK)	Reel of 3000	LM4040B25IDCKR
		SOT-23-3 (DBZ)		Reel of 3000	LM4040B25IDBZR	4NH_
				Reel of 250	LM4040B25IDBZT	
		TO-92/TO-226 (LP)		Bulk of 1000	LM4040B25ILP	PREVIEW
				Reel of 2000	LM4040B25ILPR	
		3 V		SC-70 (DCK)	Reel of 3000	LM4040B30IDCKR
			SOT-23-3 (DBZ)	Reel of 3000	LM4040B30IDBZR	4M7_
				Reel of 250	LM4040B30IDBZT	
			TO-92/TO-226 (LP)	Bulk of 1000	LM4040B30ILP	PREVIEW
				Reel of 2000	LM4040B30ILPR	
			4.096 V	SC-70 (DCK)	Reel of 3000	LM4040B41IDCKR
		SOT-23-3 (DBZ)		Reel of 3000	LM4040B41IDBZR	4M3_
				Reel of 250	LM4040B41IDBZT	
		TO-92/TO-226 (LP)		Bulk of 1000	LM4040B41ILP	PREVIEW
				Reel of 2000	LM4040B41ILPR	
		5 V		SC-70 (DCK)	Reel of 3000	LM4040B50IDCKR
			SOT-23-3 (DBZ)	Reel of 3000	LM4040B50IDBZR	4NB_
				Reel of 250	LM4040B50IDBZT	
			TO-92/TO-226 (LP)	Bulk of 1000	LM4040B50ILP	PREVIEW
Reel of 2000	LM4040B50ILPR					
8.192 V	SC-70 (DCK)		Reel of 3000	LM4040B82IDCKR	PE_	
	SOT-23-3 (DBZ)	Reel of 3000	LM4040B82IDBZR	4NM_		
		Reel of 250	LM4040B82IDBZT			
	TO-92/TO-226 (LP)	Bulk of 1000	LM4040B82ILP	PREVIEW		
		Reel of 2000	LM4040B82ILPR			
	10 V	SC-70 (DCK)	Reel of 3000	LM4040B10IDCKR	PJ_	
SOT-23-3 (DBZ)		Reel of 3000	LM4040B10IDBZR	4NR_		
		Reel of 250	LM4040B10IDBZT			
TO-92/TO-226 (LP)		Bulk of 1000	LM4040B10ILP	PREVIEW		
		Reel of 2000	LM4040B10ILPR			

# LM4040 PRECISION MICROPOWER SHUNT VOLTAGE REFERENCE

SLOS456J – JANUARY 2005 – REVISED SEPTEMBER 2006

## ORDERING INFORMATION (continued)

T <sub>A</sub>	DEVICE GRADE	V <sub>KA</sub>	PACKAGE <sup>(1)</sup>		ORDERABLE PART NUMBER	TOP-SIDE MARKING <sup>(2)</sup>
-40°C to 85°C	C grade: 0.5% initial accuracy and 100 ppm/°C temperature coefficient	2.048 V	SC-70 (DCK)	Reel of 3000	LM4040C20IDCKR	MV_
			SOT-23-3 (DBZ)	Reel of 3000	LM4040C20IDBZR	4MQ_
				Reel of 250	LM4040C20IDBZT	
			TO-92/TO-226 (LP)	Bulk of 1000	LM4040C20ILP	PREVIEW
		Reel of 2000		LM4040C20ILPR		
		2.5 V	SC-70 (DCK)	Reel of 3000	LM4040C25IDCKR	M4_
			SOT-23-3 (DBZ)	Reel of 3000	LM4040C25IDBZR	4MU_
				Reel of 250	LM4040C25IDBZT	
			TO-92/TO-226 (LP)	Bulk of 1000	LM4040C25ILP	NCF25I
		Reel of 2000		LM4040C25ILPR		
		3 V	SC-70 (DCK)	Reel of 3000	LM4040C30IDCKR	PB_
			SOT-23-3 (DBZ)	Reel of 3000	LM4040C30IDBZR	4M8_
				Reel of 250	LM4040C30IDBZT	
			TO-92/TO-226 (LP)	Bulk of 1000	LM4040C30ILP	PREVIEW
		Reel of 2000		LM4040C30ILPR		
		4.096 V	SC-70 (DCK)	Reel of 3000	LM4040C41IDCKR	P6_
			SOT-23-3 (DBZ)	Reel of 3000	LM4040C41IDBZR	4M4_
				Reel of 250	LM4040C41IDBZT	
			TO-92/TO-226 (LP)	Bulk of 1000	LM4040C41ILP	PREVIEW
		Reel of 2000		LM4040C41ILPR		
		5 V	SC-70 (DCK)	Reel of 3000	LM4040C50IDCKR	MZ_
			SOT-23-3 (DBZ)	Reel of 3000	LM4040C50IDBZR	4NC_
				Reel of 250	LM4040C50IDBZT	
			TO-92/TO-226 (LP)	Bulk of 1000	LM4040C50ILP	PREVIEW
Reel of 2000	LM4040C50ILPR					
8.192 V	SC-70 (DCK)	Reel of 3000	LM4040C82IDCKR	PF_		
	SOT-23-3 (DBZ)	Reel of 3000	LM4040C82IDBZR	4NN_		
		Reel of 250	LM4040C82IDBZT			
	TO-92/TO-226 (LP)	Bulk of 1000	LM4040C82ILP	PREVIEW		
Reel of 2000		LM4040C82ILPR				
10 V	SC-70 (DCK)	Reel of 3000	LM4040C10IDCKR	PK_		
	SOT-23-3 (DBZ)	Reel of 3000	LM4040C10IDBZR	4NS_		
		Reel of 250	LM4040C10IDBZT			
	TO-92/TO-226 (LP)	Bulk of 1000	LM4040C10ILP	NFC10I		
Reel of 2000		LM4040C10ILPR				

**ORDERING INFORMATION (continued)**

$T_A$	DEVICE GRADE	$V_{KA}$	PACKAGE <sup>(1)</sup>		ORDERABLE PART NUMBER	TOP-SIDE MARKING <sup>(2)</sup>
-40°C to 85°C	D grade: 1.0% initial accuracy and 150 ppm/°C temperature coefficient	2.048 V	SC-70 (DCK)	Reel of 3000	LM4040D20IDCKR	MW_
				SOT-23-3 (DBZ)	Reel of 3000	LM4040D20IDBZR
			Reel of 250		LM4040D20IDBZT	
			TO-92/TO-226 (LP)	Bulk of 1000	LM4040D20ILP	PREVIEW
				Reel of 2000	LM4040D20ILPR	
			2.5 V	SC-70 (DCK)	Reel of 3000	LM4040D25IDCKR
		SOT-23-3 (DBZ)			Reel of 3000	LM4040D25IDBZR
				Reel of 250	LM4040D25IDBZT	
		TO-92/TO-226 (LP)		Bulk of 1000	LM4040D25ILP	NFD25I
				Reel of 2000	LM4040D25ILPR	
		3 V		SC-70 (DCK)	Reel of 3000	LM4040D30IDCKR
			SOT-23-3 (DBZ)		Reel of 3000	LM4040D30IDBZR
				Reel of 250	LM4040D30IDBZT	
			TO-92/TO-226 (LP)	Bulk of 1000	LM4040D30ILP	PREVIEW
				Reel of 2000	LM4040D30ILPR	
			4.096 V	SC-70 (DCK)	Reel of 3000	LM4040D41IDCKR
		SOT-23-3 (DBZ)			Reel of 3000	LM4040D41IDBZR
				Reel of 250	LM4040D41IDBZT	
		TO-92/TO-226 (LP)		Bulk of 1000	LM4040D41ILP	PREVIEW
				Reel of 2000	LM4040D41ILPR	
		5 V		SC-70 (DCK)	Reel of 3000	LM4040D50IDCKR
			SOT-23-3 (DBZ)		Reel of 3000	LM4040D50IDBZR
				Reel of 250	LM4040D50IDBZT	
			TO-92/TO-226 (LP)	Bulk of 1000	LM4040D50ILP	PREVIEW
Reel of 2000	LM4040D50ILPR					
8.192 V	SC-70 (DCK)		Reel of 3000	LM4040D82IDCKR	PG_	
		SOT-23-3 (DBZ)	Reel of 3000	LM4040D82IDBZR	4NP_	
	Reel of 250		LM4040D82IDBZT			
	TO-92/TO-226 (LP)	Bulk of 1000	LM4040D82ILP	PREVIEW		
		Reel of 2000	LM4040D82ILPR			
	10 V	SC-70 (DCK)	Reel of 3000	LM4040D10IDCKR	PL_	
SOT-23-3 (DBZ)			Reel of 3000	LM4040D10IDBZR	4NT_	
		Reel of 250	LM4040D10IDBZT			
TO-92/TO-226 (LP)		Bulk of 1000	LM4040D10ILP	NFD10I		
		Reel of 2000	LM4040D10ILPR			

# LM4040 PRECISION MICROPOWER SHUNT VOLTAGE REFERENCE

SLOS456J – JANUARY 2005 – REVISED SEPTEMBER 2006

## ORDERING INFORMATION (continued)

T <sub>A</sub>	DEVICE GRADE	V <sub>KA</sub>	PACKAGE <sup>(1)</sup>	ORDERABLE PART NUMBER	TOP-SIDE MARKING <sup>(2)</sup>	
-40°C to 125°C	C grade: 0.5% initial accuracy and 100 ppm/°C temperature coefficient	2.048 V	SOT-23-3 (DBZ)	Reel of 3000	LM4040C20QDBZR	4MW_
				Reel of 250	LM4040C20QDBZT	
		2.5 V		Reel of 3000	LM4040C25QDBZR	4MA_
				Reel of 250	LM4040C25QDBZT	
		3 V		Reel of 3000	LM4040C30QDBZR	4NJ_
				Reel of 250	LM4040C30QDBZT	
		5 V		Reel of 3000	LM4040C50QDBZR	4NE_
				Reel of 250	LM4040C50QDBZT	
	D grade: 1.0% initial accuracy and 150 ppm/°C temperature coefficient	2.048 V	SOT-23-3 (DBZ)	Reel of 3000	LM4040D20QDBZR	4MY_
				Reel of 250	LM4040D20QDBZT	
		2.5 V		Reel of 3000	LM4040D25QDBZR	4MB_
				Reel of 250	LM4040D25QDBZT	
		3 V		Reel of 3000	LM4040D30QDBZR	4NK_
				Reel of 250	LM4040D30QDBZT	
5 V		Reel of 3000		LM4040D50QDBZR	4NF_	
		Reel of 250		LM4040D50QDBZT		

EEPW.com.cn

FUNCTIONAL BLOCK DIAGRAM

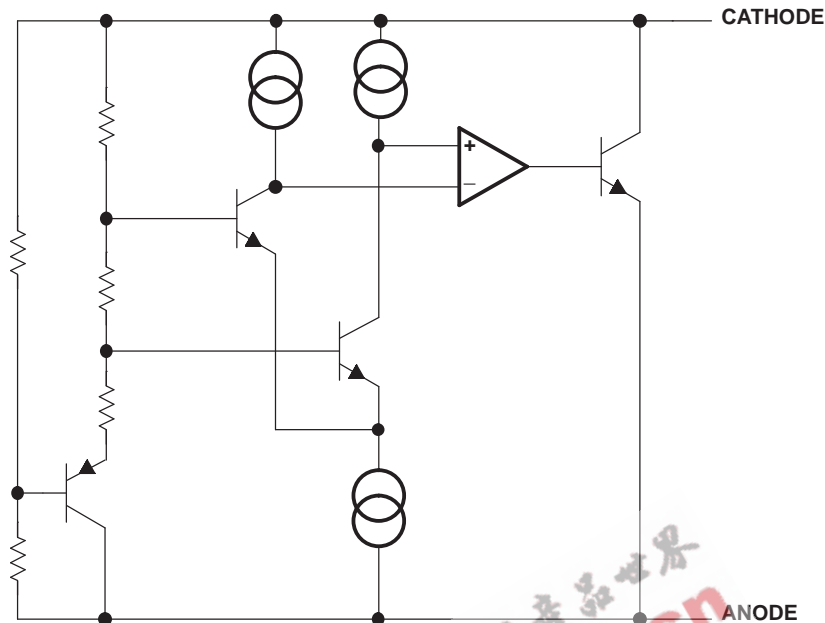

**Absolute Maximum Ratings<sup>(1)</sup>**

over free-air temperature range (unless otherwise noted)

		MIN	MAX	UNIT
$I_Z$	Continuous cathode current	-10	25	mA
$\theta_{JA}$	Package thermal impedance <sup>(2) (3)</sup>		DBZ package	206
			DCK package	252
			LP package	156
$T_J$	Operating virtual junction temperature		150	°C
$T_{stg}$	Storage temperature range	-65	150	°C

- (1) Stresses beyond those listed under "absolute maximum ratings" may cause permanent damage to the device. These are stress ratings only, and functional operation of the device at these or any other conditions beyond those indicated under "recommended operating conditions" is not implied. Exposure to absolute-maximum-rated conditions for extended periods may affect device reliability.
- (2) Maximum power dissipation is a function of  $T_J(\text{max})$ ,  $\theta_{JA}$ , and  $T_A$ . The maximum allowable power dissipation at any allowable ambient temperature is  $P_D = (T_J(\text{max}) - T_A) / \theta_{JA}$ . Operating at the absolute maximum  $T_J$  of 150°C can affect reliability.
- (3) The package thermal impedance is calculated in accordance with JESD 51-7.

**Recommended Operating Conditions<sup>(1)</sup>**

		MIN	MAX	UNIT
$I_Z$	Cathode current	(1)	12	mA
$T_A$	Free-air temperature		LM4040xxxI	-40 85
			LM4040xxxQ	-40 125

- (1) See parametric tables

# LM4040 PRECISION MICROPOWER SHUNT VOLTAGE REFERENCE



SLOS456J – JANUARY 2005 – REVISED SEPTEMBER 2006

## LM4040x20I Electrical Characteristics

at industrial temperature range, full-range  $T_A = -40^{\circ}\text{C}$  to  $85^{\circ}\text{C}$  (unless otherwise noted)

PARAMETER	TEST CONDITIONS	$T_A$	LM4040A20I			LM4040B20I			UNIT
			MIN	TYP	MAX	MIN	TYP	MAX	
$V_Z$	Reverse breakdown voltage	$I_Z = 100\ \mu\text{A}$	25 $^{\circ}\text{C}$			2.048			V
$\Delta V_Z$	Reverse breakdown voltage tolerance	$I_Z = 100\ \mu\text{A}$	25 $^{\circ}\text{C}$			-4.1			mV
			Full range			-15			
$I_{Z,\text{min}}$	Minimum cathode current		25 $^{\circ}\text{C}$			45			$\mu\text{A}$
			Full range			80			
$\alpha_{VZ}$	Average temperature coefficient of reverse breakdown voltage	$I_Z = 10\ \text{mA}$	25 $^{\circ}\text{C}$			$\pm 20$			ppm/ $^{\circ}\text{C}$
		$I_Z = 1\ \text{mA}$	25 $^{\circ}\text{C}$			$\pm 15$			
			Full range			$\pm 100$			
$\frac{\Delta V_Z}{\Delta I_Z}$	Reverse breakdown voltage change with cathode current change	$I_{Z,\text{min}} < I_Z < 1\ \text{mA}$	25 $^{\circ}\text{C}$			0.3			mV
			Full range			1			
		$1\ \text{mA} < I_Z < 15\ \text{mA}$	25 $^{\circ}\text{C}$			2.5			
			Full range			8			
$Z_Z$	Reverse dynamic impedance	$I_Z = 1\ \text{mA}$ , $f = 120\ \text{Hz}$ , $I_{\text{AC}} = 0.1 I_Z$	25 $^{\circ}\text{C}$			0.3			$\Omega$
$e_N$	Wideband noise	$I_Z = 100\ \mu\text{A}$ , $10\ \text{Hz} \leq f \leq 10\ \text{kHz}$	25 $^{\circ}\text{C}$			35			$\mu\text{V}_{\text{RMS}}$
	Long-term stability of reverse breakdown voltage	$t = 1000\ \text{h}$ , $T_A = 25^{\circ}\text{C} \pm 0.1^{\circ}\text{C}$ , $I_Z = 100\ \mu\text{A}$				120			ppm
$V_{\text{HYST}}$	Thermal hysteresis <sup>(1)</sup>	$\Delta T_A = -40^{\circ}\text{C}$ to $125^{\circ}\text{C}$				0.08			%

(1) Thermal hysteresis is defined as  $V_{Z,25^{\circ}\text{C}}$  (after cycling to  $-40^{\circ}\text{C}$ )  $- V_{Z,25^{\circ}\text{C}}$  (after cycling to  $125^{\circ}\text{C}$ ).



### LM4040x20I Electrical Characteristics

at industrial temperature range, full-range  $T_A = -40^{\circ}\text{C}$  to  $85^{\circ}\text{C}$  (unless otherwise noted)

PARAMETER	TEST CONDITIONS	$T_A$	LM4040C20I			LM4040D20I			UNIT
			MIN	TYP	MAX	MIN	TYP	MAX	
$V_Z$	Reverse breakdown voltage	$I_Z = 100\ \mu\text{A}$	25 $^{\circ}\text{C}$			2.048			V
$\Delta V_Z$	Reverse breakdown voltage tolerance	$I_Z = 100\ \mu\text{A}$	25 $^{\circ}\text{C}$			-10      10			mV
			Full range			-23      23			
$I_{Z,\text{min}}$	Minimum cathode current		25 $^{\circ}\text{C}$			45      75			$\mu\text{A}$
			Full range			80			
$\alpha_{VZ}$	Average temperature coefficient of reverse breakdown voltage	$I_Z = 10\ \text{mA}$	25 $^{\circ}\text{C}$			$\pm 20$			ppm/ $^{\circ}\text{C}$
		$I_Z = 1\ \text{mA}$	25 $^{\circ}\text{C}$			$\pm 15$			
			Full range			$\pm 100$			
$\frac{\Delta V_Z}{\Delta I_Z}$	Reverse breakdown voltage change with cathode current change	$I_{Z,\text{min}} < I_Z < 1\ \text{mA}$	25 $^{\circ}\text{C}$			0.3      0.8			mV
			Full range			1      1.2			
		$1\ \text{mA} < I_Z < 15\ \text{mA}$	25 $^{\circ}\text{C}$			2.5      6			
			Full range			8      10			
$Z_Z$	Reverse dynamic impedance	$I_Z = 1\ \text{mA}$ , $f = 120\ \text{Hz}$ , $I_{\text{AC}} = 0.1 I_Z$	25 $^{\circ}\text{C}$			0.3      0.9			$\Omega$
$e_N$	Wideband noise	$I_Z = 100\ \mu\text{A}$ , $10\ \text{Hz} \leq f \leq 10\ \text{kHz}$	25 $^{\circ}\text{C}$			35			$\mu\text{V}_{\text{RMS}}$
	Long-term stability of reverse breakdown voltage	$t = 1000\ \text{h}$ , $T_A = 25^{\circ}\text{C} \pm 0.1^{\circ}\text{C}$ , $I_Z = 100\ \mu\text{A}$				120			ppm
$V_{\text{HYST}}$	Thermal hysteresis <sup>(1)</sup>	$\Delta T_A = -40^{\circ}\text{C}$ to $125^{\circ}\text{C}$				0.08			%

(1) Thermal hysteresis is defined as  $V_{Z,25^{\circ}\text{C}}$  (after cycling to  $-40^{\circ}\text{C}$ )  $- V_{Z,25^{\circ}\text{C}}$  (after cycling to  $125^{\circ}\text{C}$ ).

# LM4040 PRECISION MICROPOWER SHUNT VOLTAGE REFERENCE

SLOS456J – JANUARY 2005 – REVISED SEPTEMBER 2006

## LM4040x20Q Electrical Characteristics

at extended temperature range, full-range  $T_A = -40^\circ\text{C}$  to  $125^\circ\text{C}$  (unless otherwise noted)

PARAMETER	TEST CONDITIONS	$T_A$	LM4040C20Q			LM4040D20Q			UNIT
			MIN	TYP	MAX	MIN	TYP	MAX	
$V_Z$	Reverse breakdown voltage	$I_Z = 100\ \mu\text{A}$	25°C			2.048			V
$\Delta V_Z$	Reverse breakdown voltage tolerance	$I_Z = 100\ \mu\text{A}$	25°C			-10      10			mV
			Full range			-30      30			
$I_{Z,\text{min}}$	Minimum cathode current		25°C			45      75			$\mu\text{A}$
			Full range			80			
$\alpha_{VZ}$	Average temperature coefficient of reverse breakdown voltage	$I_Z = 10\ \text{mA}$	25°C			$\pm 20$			ppm/°C
		$I_Z = 1\ \text{mA}$	25°C			$\pm 15$			
			Full range			$\pm 100$			
		$I_Z = 100\ \mu\text{A}$	25°C			$\pm 15$			
$\frac{\Delta V_Z}{\Delta I_Z}$	Reverse breakdown voltage change with cathode current change	$I_{Z,\text{min}} < I_Z < 1\ \text{mA}$	25°C			0.3      0.8			mV
			Full range			1      1.2			
		$1\ \text{mA} < I_Z < 15\ \text{mA}$	25°C			2.5      6			
			Full range			8      10			
$Z_Z$	Reverse dynamic impedance	$I_Z = 1\ \text{mA}$ , $f = 120\ \text{Hz}$ , $I_{\text{AC}} = 0.1 I_Z$	25°C			0.3      0.9			$\Omega$
$e_N$	Wideband noise	$I_Z = 100\ \mu\text{A}$ , $10\ \text{Hz} \leq f \leq 10\ \text{kHz}$	25°C			35			$\mu\text{V}_{\text{RMS}}$
	Long-term stability of reverse breakdown voltage	$t = 1000\ \text{h}$ , $T_A = 25^\circ\text{C} \pm 0.1^\circ\text{C}$ , $I_Z = 100\ \mu\text{A}$				120			ppm
$V_{\text{HYST}}$	Thermal hysteresis <sup>(1)</sup>	$\Delta T_A = -40^\circ\text{C}$ to $125^\circ\text{C}$				0.08			%

(1) Thermal hysteresis is defined as  $V_{Z,25^\circ\text{C}}$  (after cycling to  $-40^\circ\text{C}$ )  $- V_{Z,25^\circ\text{C}}$  (after cycling to  $125^\circ\text{C}$ ).

### LM4040x25I Electrical Characteristics

at industrial temperature range, full-range  $T_A = -40^{\circ}\text{C}$  to  $85^{\circ}\text{C}$  (unless otherwise noted)

PARAMETER	TEST CONDITIONS	$T_A$	LM4040A25I			LM4040B25I			UNIT
			MIN	TYP	MAX	MIN	TYP	MAX	
$V_Z$	Reverse breakdown voltage	$I_Z = 100\ \mu\text{A}$	25 $^{\circ}\text{C}$			2.5			V
$\Delta V_Z$	Reverse breakdown voltage tolerance	$I_Z = 100\ \mu\text{A}$	25 $^{\circ}\text{C}$			-2.5      2.5			mV
			Full range			-19      19			
$I_{Z,\text{min}}$	Minimum cathode current		25 $^{\circ}\text{C}$			45      75			$\mu\text{A}$
			Full range			80			
$\alpha_{VZ}$	Average temperature coefficient of reverse breakdown voltage	$I_Z = 10\ \text{mA}$	25 $^{\circ}\text{C}$			$\pm 20$			ppm/ $^{\circ}\text{C}$
		$I_Z = 1\ \text{mA}$	25 $^{\circ}\text{C}$			$\pm 15$			
			Full range			$\pm 100$			
$\frac{\Delta V_Z}{\Delta I_Z}$	Reverse breakdown voltage change with cathode current change	$I_{Z,\text{min}} < I_Z < 1\ \text{mA}$	25 $^{\circ}\text{C}$			0.3      0.8			mV
			Full range			1			
		$1\ \text{mA} < I_Z < 15\ \text{mA}$	25 $^{\circ}\text{C}$			2.5      6			
			Full range			8			
$Z_Z$	Reverse dynamic impedance	$I_Z = 1\ \text{mA}$ , $f = 120\ \text{Hz}$ , $I_{\text{AC}} = 0.1 I_Z$	25 $^{\circ}\text{C}$			0.3      0.8			$\Omega$
$e_N$	Wideband noise	$I_Z = 100\ \mu\text{A}$ , $10\ \text{Hz} \leq f \leq 10\ \text{kHz}$	25 $^{\circ}\text{C}$			35			$\mu\text{V}_{\text{RMS}}$
	Long-term stability of reverse breakdown voltage	$t = 1000\ \text{h}$ , $T_A = 25^{\circ}\text{C} \pm 0.1^{\circ}\text{C}$ , $I_Z = 100\ \mu\text{A}$				120			ppm
$V_{\text{HYST}}$	Thermal hysteresis <sup>(1)</sup>	$\Delta T_A = -40^{\circ}\text{C}$ to $125^{\circ}\text{C}$				0.08			%

(1) Thermal hysteresis is defined as  $V_{Z,25^{\circ}\text{C}}$  (after cycling to  $-40^{\circ}\text{C}$ )  $- V_{Z,25^{\circ}\text{C}}$  (after cycling to  $125^{\circ}\text{C}$ ).

# LM4040 PRECISION MICROPOWER SHUNT VOLTAGE REFERENCE



SLOS456J – JANUARY 2005 – REVISED SEPTEMBER 2006

## LM4040x25I Electrical Characteristics

at industrial temperature range, full-range  $T_A = -40^{\circ}\text{C}$  to  $85^{\circ}\text{C}$  (unless otherwise noted)

PARAMETER	TEST CONDITIONS	$T_A$	LM4040C25I			LM4040D25I			UNIT
			MIN	TYP	MAX	MIN	TYP	MAX	
$V_Z$	Reverse breakdown voltage	$I_Z = 100\ \mu\text{A}$	25 $^{\circ}\text{C}$			2.5			V
$\Delta V_Z$	Reverse breakdown voltage tolerance	$I_Z = 100\ \mu\text{A}$	25 $^{\circ}\text{C}$			-12      12			mV
			Full range			-29      29			
$I_{Z,\text{min}}$	Minimum cathode current		25 $^{\circ}\text{C}$			45      75			$\mu\text{A}$
			Full range			80			
$\alpha_{VZ}$	Average temperature coefficient of reverse breakdown voltage	$I_Z = 10\ \text{mA}$	25 $^{\circ}\text{C}$			$\pm 20$			ppm/ $^{\circ}\text{C}$
		$I_Z = 1\ \text{mA}$	25 $^{\circ}\text{C}$			$\pm 15$			
			Full range			$\pm 100$			
$\frac{\Delta V_Z}{\Delta I_Z}$	Reverse breakdown voltage change with cathode current change	$I_{Z,\text{min}} < I_Z < 1\ \text{mA}$	25 $^{\circ}\text{C}$			0.3      0.8			mV
			Full range			1      1.2			
		$1\ \text{mA} < I_Z < 15\ \text{mA}$	25 $^{\circ}\text{C}$			2.5      6			
			Full range			8      10			
$Z_Z$	Reverse dynamic impedance	$I_Z = 1\ \text{mA}$ , $f = 120\ \text{Hz}$ , $I_{\text{AC}} = 0.1 I_Z$	25 $^{\circ}\text{C}$			0.3      0.9			$\Omega$
$e_N$	Wideband noise	$I_Z = 100\ \mu\text{A}$ , $10\ \text{Hz} \leq f \leq 10\ \text{kHz}$	25 $^{\circ}\text{C}$			35			$\mu\text{V}_{\text{RMS}}$
	Long-term stability of reverse breakdown voltage	$t = 1000\ \text{h}$ , $T_A = 25^{\circ}\text{C} \pm 0.1^{\circ}\text{C}$ , $I_Z = 100\ \mu\text{A}$				120			ppm
$V_{\text{HYST}}$	Thermal hysteresis <sup>(1)</sup>	$\Delta T_A = -40^{\circ}\text{C}$ to $125^{\circ}\text{C}$				0.08			%

(1) Thermal hysteresis is defined as  $V_{Z,25^{\circ}\text{C}}$  (after cycling to  $-40^{\circ}\text{C}$ ) –  $V_{Z,25^{\circ}\text{C}}$  (after cycling to  $125^{\circ}\text{C}$ ).

### LM4040x25Q Electrical Characteristics

at extended temperature range, full-range  $T_A = -40^{\circ}\text{C}$  to  $125^{\circ}\text{C}$  (unless otherwise noted)

PARAMETER	TEST CONDITIONS	$T_A$	LM4040C25Q			LM4040D25Q			UNIT
			MIN	TYP	MAX	MIN	TYP	MAX	
$V_Z$	Reverse breakdown voltage	$I_Z = 100\ \mu\text{A}$	25 $^{\circ}\text{C}$			2.5			V
$\Delta V_Z$	Reverse breakdown voltage tolerance	$I_Z = 100\ \mu\text{A}$	25 $^{\circ}\text{C}$			-12      12			mV
			Full range			-38      38			
$I_{Z,\text{min}}$	Minimum cathode current		25 $^{\circ}\text{C}$			45      75			$\mu\text{A}$
			Full range			80			
$\alpha_{VZ}$	Average temperature coefficient of reverse breakdown voltage	$I_Z = 10\ \text{mA}$	25 $^{\circ}\text{C}$			$\pm 20$			ppm/ $^{\circ}\text{C}$
		$I_Z = 1\ \text{mA}$	25 $^{\circ}\text{C}$			$\pm 15$			
			Full range			$\pm 100$			
$\frac{\Delta V_Z}{\Delta I_Z}$	Reverse breakdown voltage change with cathode current change	$I_{Z,\text{min}} < I_Z < 1\ \text{mA}$	25 $^{\circ}\text{C}$			0.3      0.8			mV
			Full range			1      1.2			
		$1\ \text{mA} < I_Z < 15\ \text{mA}$	25 $^{\circ}\text{C}$			2.5      6			
			Full range			8      10			
$Z_Z$	Reverse dynamic impedance	$I_Z = 1\ \text{mA}$ , $f = 120\ \text{Hz}$ , $I_{\text{AC}} = 0.1 I_Z$	25 $^{\circ}\text{C}$			0.3      0.9			$\Omega$
$e_N$	Wideband noise	$I_Z = 100\ \mu\text{A}$ , $10\ \text{Hz} \leq f \leq 10\ \text{kHz}$	25 $^{\circ}\text{C}$			35			$\mu\text{V}_{\text{RMS}}$
	Long-term stability of reverse breakdown voltage	$t = 1000\ \text{h}$ , $T_A = 25^{\circ}\text{C} \pm 0.1^{\circ}\text{C}$ , $I_Z = 100\ \mu\text{A}$				120			ppm
$V_{\text{HYST}}$	Thermal hysteresis <sup>(1)</sup>	$\Delta T_A = -40^{\circ}\text{C}$ to $125^{\circ}\text{C}$				0.08			%

(1) Thermal hysteresis is defined as  $V_{Z,25^{\circ}\text{C}}$  (after cycling to  $-40^{\circ}\text{C}$ )  $- V_{Z,25^{\circ}\text{C}}$  (after cycling to  $125^{\circ}\text{C}$ ).

# LM4040 PRECISION MICROPOWER SHUNT VOLTAGE REFERENCE

SLOS456J – JANUARY 2005 – REVISED SEPTEMBER 2006

## LM4040x30I Electrical Characteristics

at industrial temperature range, full-range  $T_A = -40^{\circ}\text{C}$  to  $85^{\circ}\text{C}$  (unless otherwise noted)

PARAMETER	TEST CONDITIONS	$T_A$	LM4040A30I			LM4040B30I			UNIT	
			MIN	TYP	MAX	MIN	TYP	MAX		
$V_Z$	Reverse breakdown voltage	$I_Z = 100\ \mu\text{A}$	25°C			3			V	
$\Delta V_Z$	Reverse breakdown voltage tolerance	$I_Z = 100\ \mu\text{A}$	25°C			-3			mV	
			Full range			-22				
$I_{Z,\text{min}}$	Minimum cathode current		25°C			47			$\mu\text{A}$	
			Full range			82				
$\alpha_{VZ}$	Average temperature coefficient of reverse breakdown voltage	$I_Z = 10\ \text{mA}$	25°C			$\pm 20$			ppm/°C	
		$I_Z = 1\ \text{mA}$	25°C			$\pm 15$				
			Full range			$\pm 100$				
$\frac{\Delta V_Z}{\Delta I_Z}$	Reverse breakdown voltage change with cathode current change	$I_{Z,\text{min}} < I_Z < 1\ \text{mA}$	25°C			0.6		0.8		mV
			Full range			1.1		1.1		
		$1\ \text{mA} < I_Z < 15\ \text{mA}$	25°C			2.7		6		
			Full range			9		9		
$Z_Z$	Reverse dynamic impedance	$I_Z = 1\ \text{mA}$ , $f = 120\ \text{Hz}$ , $I_{\text{AC}} = 0.1 I_Z$	25°C			0.4		0.9		$\Omega$
$e_N$	Wideband noise	$I_Z = 100\ \mu\text{A}$ , $10\ \text{Hz} \leq f \leq 10\ \text{kHz}$	25°C			35		35		$\mu\text{V}_{\text{RMS}}$
	Long-term stability of reverse breakdown voltage	$t = 1000\ \text{h}$ , $T_A = 25^{\circ}\text{C} \pm 0.1^{\circ}\text{C}$ , $I_Z = 100\ \mu\text{A}$				120		120		ppm
$V_{\text{HYST}}$	Thermal hysteresis <sup>(1)</sup>	$\Delta T_A = -40^{\circ}\text{C}$ to $125^{\circ}\text{C}$				0.08		0.08		%

(1) Thermal hysteresis is defined as  $V_{Z,25^{\circ}\text{C}}$  (after cycling to  $-40^{\circ}\text{C}$ ) –  $V_{Z,25^{\circ}\text{C}}$  (after cycling to  $125^{\circ}\text{C}$ ).

### LM4040x30I Electrical Characteristics

at industrial temperature range, full-range  $T_A = -40^{\circ}\text{C}$  to  $85^{\circ}\text{C}$  (unless otherwise noted)

PARAMETER	TEST CONDITIONS	$T_A$	LM4040C30I			LM4040D30I			UNIT
			MIN	TYP	MAX	MIN	TYP	MAX	
$V_Z$	Reverse breakdown voltage	$I_Z = 100\ \mu\text{A}$	25°C			3			V
$\Delta V_Z$	Reverse breakdown voltage tolerance	$I_Z = 100\ \mu\text{A}$	25°C			-15      15			mV
			Full range			-34      34			
$I_{Z,\text{min}}$	Minimum cathode current		25°C			45      77			$\mu\text{A}$
			Full range			82			
$\alpha_{VZ}$	Average temperature coefficient of reverse breakdown voltage	$I_Z = 10\ \text{mA}$	25°C			$\pm 20$			ppm/°C
		$I_Z = 1\ \text{mA}$	25°C			$\pm 15$			
			Full range			$\pm 100$			
$\frac{\Delta V_Z}{\Delta I_Z}$	Reverse breakdown voltage change with cathode current change	$I_{Z,\text{min}} < I_Z < 1\ \text{mA}$	25°C			0.4      0.8      1.4      1			mV
			Full range			1.1      1.3			
		$1\ \text{mA} < I_Z < 15\ \text{mA}$	25°C			2.7      6      2.7      8			
			Full range			9      11			
$Z_Z$	Reverse dynamic impedance	$I_Z = 1\ \text{mA}$ , $f = 120\ \text{Hz}$ , $I_{\text{AC}} = 0.1 I_Z$	25°C			0.4      0.9      0.4      1.2			$\Omega$
$e_N$	Wideband noise	$I_Z = 100\ \mu\text{A}$ , $10\ \text{Hz} \leq f \leq 10\ \text{kHz}$	25°C			35      35			$\mu\text{V}_{\text{RMS}}$
	Long-term stability of reverse breakdown voltage	$t = 1000\ \text{h}$ , $T_A = 25^{\circ}\text{C} \pm 0.1^{\circ}\text{C}$ , $I_Z = 100\ \mu\text{A}$				120      120			ppm
$V_{\text{HYST}}$	Thermal hysteresis <sup>(1)</sup>	$\Delta T_A = -40^{\circ}\text{C}$ to $125^{\circ}\text{C}$				0.08      0.08			%

(1) Thermal hysteresis is defined as  $V_{Z,25^{\circ}\text{C}}$  (after cycling to  $-40^{\circ}\text{C}$ ) –  $V_{Z,25^{\circ}\text{C}}$  (after cycling to  $125^{\circ}\text{C}$ ).

# LM4040 PRECISION MICROPOWER SHUNT VOLTAGE REFERENCE

SLOS456J – JANUARY 2005 – REVISED SEPTEMBER 2006

## LM4040x30Q Electrical Characteristics

at extended temperature range, full-range  $T_A = -40^\circ\text{C}$  to  $125^\circ\text{C}$  (unless otherwise noted)

PARAMETER	TEST CONDITIONS	$T_A$	LM4040C30Q			LM4040D30Q			UNIT
			MIN	TYP	MAX	MIN	TYP	MAX	
$V_Z$	Reverse breakdown voltage	$I_Z = 100\ \mu\text{A}$	25°C			3			V
$\Delta V_Z$	Reverse breakdown voltage tolerance	$I_Z = 100\ \mu\text{A}$	25°C			-15      15			mV
			Full range			-45      45			
$I_{Z,\text{min}}$	Minimum cathode current		25°C			47      77			$\mu\text{A}$
			Full range			82			
$\alpha_{VZ}$	Average temperature coefficient of reverse breakdown voltage	$I_Z = 10\ \text{mA}$	25°C			$\pm 20$			ppm/°C
		$I_Z = 1\ \text{mA}$	25°C			$\pm 15$			
			Full range			$\pm 100$			
$\frac{\Delta V_Z}{\Delta I_Z}$	Reverse breakdown voltage change with cathode current change	$I_{Z,\text{min}} < I_Z < 1\ \text{mA}$	25°C			0.4      0.8			mV
			Full range			1.1			
		$1\ \text{mA} < I_Z < 15\ \text{mA}$	25°C			2.7      6			
			Full range			9			
$Z_Z$	Reverse dynamic impedance	$I_Z = 1\ \text{mA}$ , $f = 120\ \text{Hz}$ , $I_{\text{AC}} = 0.1 I_Z$	25°C			0.4      0.9			$\Omega$
$e_N$	Wideband noise	$I_Z = 100\ \mu\text{A}$ , $10\ \text{Hz} \leq f \leq 10\ \text{kHz}$	25°C			35			$\mu\text{V}_{\text{RMS}}$
	Long-term stability of reverse breakdown voltage	$t = 1000\ \text{h}$ , $T_A = 25^\circ\text{C} \pm 0.1^\circ\text{C}$ , $I_Z = 100\ \mu\text{A}$				120			ppm
$V_{\text{HYST}}$	Thermal hysteresis <sup>(1)</sup>	$\Delta T_A = -40^\circ\text{C}$ to $125^\circ\text{C}$				0.08			%

(1) Thermal hysteresis is defined as  $V_{Z,25^\circ\text{C}}$  (after cycling to  $-40^\circ\text{C}$ ) –  $V_{Z,25^\circ\text{C}}$  (after cycling to  $125^\circ\text{C}$ ).



### LM4040x41I Electrical Characteristics

at industrial temperature range, full-range  $T_A = -40^\circ\text{C}$  to  $85^\circ\text{C}$  (unless otherwise noted)

PARAMETER	TEST CONDITIONS	$T_A$	LM4040A41I			LM4040B41I			UNIT
			MIN	TYP	MAX	MIN	TYP	MAX	
$V_Z$	Reverse breakdown voltage	$I_Z = 100\ \mu\text{A}$	25°C			4.096			V
$\Delta V_Z$	Reverse breakdown voltage tolerance	$I_Z = 100\ \mu\text{A}$	25°C			-4.1      4.1			mV
			Full range			-31      31			
$I_{Z,\text{min}}$	Minimum cathode current		25°C			50      83			$\mu\text{A}$
			Full range			88			
$\alpha_{VZ}$	Average temperature coefficient of reverse breakdown voltage	$I_Z = 10\ \text{mA}$	25°C			$\pm 30$			ppm/°C
		$I_Z = 1\ \text{mA}$	25°C			$\pm 20$			
			Full range			$\pm 100$			
$\frac{\Delta V_Z}{\Delta I_Z}$	Reverse breakdown voltage change with cathode current change	$I_{Z,\text{min}} < I_Z < 1\ \text{mA}$	25°C			0.5      0.9			mV
			Full range			1.2			
		$1\ \text{mA} < I_Z < 15\ \text{mA}$	25°C			3      7			
			Full range			10			
$Z_Z$	Reverse dynamic impedance	$I_Z = 1\ \text{mA}$ , $f = 120\ \text{Hz}$ , $I_{\text{AC}} = 0.1\ I_Z$	25°C			0.5      1			$\Omega$
$e_N$	Wideband noise	$I_Z = 100\ \mu\text{A}$ , $10\ \text{Hz} \leq f \leq 10\ \text{kHz}$	25°C			80			$\mu\text{V}_{\text{RMS}}$
	Long-term stability of reverse breakdown voltage	$t = 1000\ \text{h}$ , $T_A = 25^\circ\text{C} \pm 0.1^\circ\text{C}$ , $I_Z = 100\ \mu\text{A}$				120			ppm
$V_{\text{HYST}}$	Thermal hysteresis <sup>(1)</sup>	$\Delta T_A = -40^\circ\text{C}$ to $125^\circ\text{C}$				0.08			%

(1) Thermal hysteresis is defined as  $V_{Z,25^\circ\text{C}}$  (after cycling to  $-40^\circ\text{C}$ ) –  $V_{Z,25^\circ\text{C}}$  (after cycling to  $125^\circ\text{C}$ ).

# LM4040 PRECISION MICROPOWER SHUNT VOLTAGE REFERENCE

SLOS456J – JANUARY 2005 – REVISED SEPTEMBER 2006

## LM4040x41I Electrical Characteristics

at industrial temperature range, full-range  $T_A = -40^{\circ}\text{C}$  to  $85^{\circ}\text{C}$  (unless otherwise noted)

PARAMETER	TEST CONDITIONS	$T_A$	LM4040C41I			LM4040D41I			UNIT
			MIN	TYP	MAX	MIN	TYP	MAX	
$V_Z$	Reverse breakdown voltage	$I_Z = 100\ \mu\text{A}$	25°C			4.096			V
$\Delta V_Z$	Reverse breakdown voltage tolerance	$I_Z = 100\ \mu\text{A}$	25°C			-20      20			mV
			Full range			-47      47			
$I_{Z,\text{min}}$	Minimum cathode current		25°C			50      83			$\mu\text{A}$
			Full range			88			
$\alpha_{VZ}$	Average temperature coefficient of reverse breakdown voltage	$I_Z = 10\ \text{mA}$	25°C			$\pm 30$			ppm/°C
		$I_Z = 1\ \text{mA}$	25°C			$\pm 20$			
			Full range			$\pm 100$			
$\frac{\Delta V_Z}{\Delta I_Z}$	Reverse breakdown voltage change with cathode current change	$I_{Z,\text{min}} < I_Z < 1\ \text{mA}$	25°C			0.5      0.9      0.5      1.2			mV
			Full range			1.2      1.5			
		$1\ \text{mA} < I_Z < 15\ \text{mA}$	25°C			3      7      3      9			
			Full range			10      13			
$Z_Z$	Reverse dynamic impedance	$I_Z = 1\ \text{mA}$ , $f = 120\ \text{Hz}$ , $I_{\text{AC}} = 0.1 I_Z$	25°C			0.5      1      0.5      1.3			$\Omega$
$e_N$	Wideband noise	$I_Z = 100\ \mu\text{A}$ , $10\ \text{Hz} \leq f \leq 10\ \text{kHz}$	25°C			80      80			$\mu\text{V}_{\text{RMS}}$
	Long-term stability of reverse breakdown voltage	$t = 1000\ \text{h}$ , $T_A = 25^{\circ}\text{C} \pm 0.1^{\circ}\text{C}$ , $I_Z = 100\ \mu\text{A}$				120      120			ppm
$V_{\text{HYST}}$	Thermal hysteresis <sup>(1)</sup>	$\Delta T_A = -40^{\circ}\text{C}$ to $125^{\circ}\text{C}$				0.08      0.08			%

(1) Thermal hysteresis is defined as  $V_{Z,25^{\circ}\text{C}}$  (after cycling to  $-40^{\circ}\text{C}$ )  $- V_{Z,25^{\circ}\text{C}}$  (after cycling to  $125^{\circ}\text{C}$ ).

### LM4040x50I Electrical Characteristics

at industrial temperature range, full-range  $T_A = -40^{\circ}\text{C}$  to  $85^{\circ}\text{C}$  (unless otherwise noted)

PARAMETER	TEST CONDITIONS	$T_A$	LM4040A50I			LM4040B50I			UNIT
			MIN	TYP	MAX	MIN	TYP	MAX	
$V_Z$	Reverse breakdown voltage	$I_Z = 100\ \mu\text{A}$	25°C			5			V
$\Delta V_Z$	Reverse breakdown voltage tolerance	$I_Z = 100\ \mu\text{A}$	25°C			-5      5			mV
			Full range			-38      38			
$I_{Z,\text{min}}$	Minimum cathode current		25°C			65      89			$\mu\text{A}$
			Full range			95			
$\alpha_{VZ}$	Average temperature coefficient of reverse breakdown voltage	$I_Z = 10\ \text{mA}$	25°C			$\pm 30$			ppm/°C
		$I_Z = 1\ \text{mA}$	25°C			$\pm 20$			
			Full range			$\pm 100$			
$\frac{\Delta V_Z}{\Delta I_Z}$	Reverse breakdown voltage change with cathode current change	$I_{Z,\text{min}} < I_Z < 1\ \text{mA}$	25°C			0.5      1			mV
			Full range			1.4			
		$1\ \text{mA} < I_Z < 15\ \text{mA}$	25°C			3.5      8			
			Full range			12			
$Z_Z$	Reverse dynamic impedance	$I_Z = 1\ \text{mA}$ , $f = 120\ \text{Hz}$ , $I_{AC} = 0.1 I_Z$	25°C			0.5      1.1			$\Omega$
$e_N$	Wideband noise	$I_Z = 100\ \mu\text{A}$ , $10\ \text{Hz} \leq f \leq 10\ \text{kHz}$	25°C			80			$\mu\text{V}_{\text{RMS}}$
	Long-term stability of reverse breakdown voltage	$t = 1000\ \text{h}$ , $T_A = 25^{\circ}\text{C} \pm 0.1^{\circ}\text{C}$ , $I_Z = 100\ \mu\text{A}$				120			ppm
$V_{\text{HYST}}$	Thermal hysteresis <sup>(1)</sup>	$\Delta T_A = -40^{\circ}\text{C}$ to $125^{\circ}\text{C}$				0.08			%

(1) Thermal hysteresis is defined as  $V_{Z,25^{\circ}\text{C}}$  (after cycling to  $-40^{\circ}\text{C}$ ) –  $V_{Z,25^{\circ}\text{C}}$  (after cycling to  $125^{\circ}\text{C}$ ).

# LM4040 PRECISION MICROPOWER SHUNT VOLTAGE REFERENCE

SLOS456J – JANUARY 2005 – REVISED SEPTEMBER 2006

## LM4040x50I Electrical Characteristics

at industrial temperature range, full-range  $T_A = -40^\circ\text{C}$  to  $85^\circ\text{C}$  (unless otherwise noted)

PARAMETER	TEST CONDITIONS	$T_A$	LM4040C50I			LM4040D50I			UNIT
			MIN	TYP	MAX	MIN	TYP	MAX	
$V_Z$	Reverse breakdown voltage	$I_Z = 100\ \mu\text{A}$	25°C			5			V
$\Delta V_Z$	Reverse breakdown voltage tolerance	$I_Z = 100\ \mu\text{A}$	25°C			-25      25			mV
			Full range			-58      58			
$I_{Z,\text{min}}$	Minimum cathode current		25°C			65      89			$\mu\text{A}$
			Full range			95			
$\alpha_{VZ}$	Average temperature coefficient of reverse breakdown voltage	$I_Z = 10\ \text{mA}$	25°C			$\pm 30$			ppm/°C
		$I_Z = 1\ \text{mA}$	25°C			$\pm 20$			
			Full range			$\pm 100$			
$\frac{\Delta V_Z}{\Delta I_Z}$	Reverse breakdown voltage change with cathode current change	$I_{Z,\text{min}} < I_Z < 1\ \text{mA}$	25°C			0.5      1      0.5      1.3			mV
			Full range			1.4      1.8			
		$1\ \text{mA} < I_Z < 15\ \text{mA}$	25°C			3.5      8      3.5      10			
			Full range			12      15			
$Z_Z$	Reverse dynamic impedance	$I_Z = 1\ \text{mA}$ , $f = 120\ \text{Hz}$ , $I_{\text{AC}} = 0.1 I_Z$	25°C			0.5      1.1      0.5      1.5			$\Omega$
$e_N$	Wideband noise	$I_Z = 100\ \mu\text{A}$ , $10\ \text{Hz} \leq f \leq 10\ \text{kHz}$	25°C			80      80			$\mu\text{V}_{\text{RMS}}$
	Long-term stability of reverse breakdown voltage	$t = 1000\ \text{h}$ , $T_A = 25^\circ\text{C} \pm 0.1^\circ\text{C}$ , $I_Z = 100\ \mu\text{A}$				120      120			ppm
$V_{\text{HYST}}$	Thermal hysteresis <sup>(1)</sup>	$\Delta T_A = -40^\circ\text{C}$ to $125^\circ\text{C}$				0.08      0.08			%

(1) Thermal hysteresis is defined as  $V_{Z,25^\circ\text{C}}$  (after cycling to  $-40^\circ\text{C}$ ) –  $V_{Z,25^\circ\text{C}}$  (after cycling to  $125^\circ\text{C}$ ).

### LM4040x50Q Electrical Characteristics

at extended temperature range, full-range  $T_A = -40^{\circ}\text{C}$  to  $125^{\circ}\text{C}$  (unless otherwise noted)

PARAMETER	TEST CONDITIONS	$T_A$	LM4040C50Q			LM4040D50Q			UNIT
			MIN	TYP	MAX	MIN	TYP	MAX	
$V_Z$	Reverse breakdown voltage	$I_Z = 100\ \mu\text{A}$	25°C			5			V
$\Delta V_Z$	Reverse breakdown voltage tolerance	$I_Z = 100\ \mu\text{A}$	25°C			-25      25			mV
			Full range			-75      75			
$I_{Z,\text{min}}$	Minimum cathode current		25°C			65      89			$\mu\text{A}$
			Full range			95			
$\alpha_{VZ}$	Average temperature coefficient of reverse breakdown voltage	$I_Z = 10\ \text{mA}$	25°C			$\pm 30$			ppm/°C
		$I_Z = 1\ \text{mA}$	25°C			$\pm 20$			
			Full range			$\pm 100$			
$\frac{\Delta V_Z}{\Delta I_Z}$	Reverse breakdown voltage change with cathode current change	$I_{Z,\text{min}} < I_Z < 1\ \text{mA}$	25°C			0.5      1			mV
			Full range			1.4      1.8			
		$1\ \text{mA} < I_Z < 15\ \text{mA}$	25°C			3.5      8			
			Full range			12      12			
$Z_Z$	Reverse dynamic impedance	$I_Z = 1\ \text{mA}$ , $f = 120\ \text{Hz}$ , $I_{\text{AC}} = 0.1\ I_Z$	25°C			0.5      1.1			$\Omega$
$e_N$	Wideband noise	$I_Z = 100\ \mu\text{A}$ , $10\ \text{Hz} \leq f \leq 10\ \text{kHz}$	25°C			80			$\mu\text{V}_{\text{RMS}}$
	Long-term stability of reverse breakdown voltage	$t = 1000\ \text{h}$ , $T_A = 25^{\circ}\text{C} \pm 0.1^{\circ}\text{C}$ , $I_Z = 100\ \mu\text{A}$				120			ppm
$V_{\text{HYST}}$	Thermal hysteresis <sup>(1)</sup>	$\Delta T_A = -40^{\circ}\text{C}$ to $125^{\circ}\text{C}$				0.08			%

(1) Thermal hysteresis is defined as  $V_{Z,25^{\circ}\text{C}}$  (after cycling to  $-40^{\circ}\text{C}$ )  $- V_{Z,25^{\circ}\text{C}}$  (after cycling to  $125^{\circ}\text{C}$ ).

# LM4040 PRECISION MICROPOWER SHUNT VOLTAGE REFERENCE

SLOS456J – JANUARY 2005 – REVISED SEPTEMBER 2006

## LM4040x82I Electrical Characteristics

at industrial temperature range, full-range  $T_A = -40^{\circ}\text{C}$  to  $85^{\circ}\text{C}$  (unless otherwise noted)

PARAMETER	TEST CONDITIONS	$T_A$	LM4040A82I			LM4040B82I			UNIT
			MIN	TYP	MAX	MIN	TYP	MAX	
$V_Z$	Reverse breakdown voltage	$I_Z = 150\ \mu\text{A}$	25°C			8.192			V
$\Delta V_Z$	Reverse breakdown voltage tolerance	$I_Z = 150\ \mu\text{A}$	25°C			-8.2      8.2			mV
			Full range			-61      61			
$I_{Z,\text{min}}$	Minimum cathode current		25°C			67      106			$\mu\text{A}$
			Full range			110			
$\alpha_{VZ}$	Average temperature coefficient of reverse breakdown voltage	$I_Z = 10\ \text{mA}$	25°C			$\pm 40$			ppm/°C
		$I_Z = 1\ \text{mA}$	25°C			$\pm 20$			
			Full range			$\pm 100$			
$\frac{\Delta V_Z}{\Delta I_Z}$	Reverse breakdown voltage change with cathode current change	$I_{Z,\text{min}} < I_Z < 1\ \text{mA}$	25°C			0.6      1.3			mV
			Full range			2.5			
		$1\ \text{mA} < I_Z < 15\ \text{mA}$	25°C			7      10			
			Full range			18			
$Z_Z$	Reverse dynamic impedance	$I_Z = 1\ \text{mA}$ , $f = 120\ \text{Hz}$ , $I_{\text{AC}} = 0.1 I_Z$	25°C			0.6      1.5			$\Omega$
$e_N$	Wideband noise	$I_Z = 150\ \mu\text{A}$ , $10\ \text{Hz} \leq f \leq 10\ \text{kHz}$	25°C			130			$\mu\text{V}_{\text{RMS}}$
	Long-term stability of reverse breakdown voltage	$t = 1000\ \text{h}$ , $T_A = 25^{\circ}\text{C} \pm 0.1^{\circ}\text{C}$ , $I_Z = 150\ \mu\text{A}$				120			ppm
$V_{\text{HYST}}$	Thermal hysteresis <sup>(1)</sup>	$\Delta T_A = -40^{\circ}\text{C}$ to $125^{\circ}\text{C}$				0.08			%

(1) Thermal hysteresis is defined as  $V_{Z,25^{\circ}\text{C}}$  (after cycling to  $-40^{\circ}\text{C}$ )  $- V_{Z,25^{\circ}\text{C}}$  (after cycling to  $125^{\circ}\text{C}$ ).

### LM4040x82I Electrical Characteristics

at industrial temperature range, full-range  $T_A = -40^{\circ}\text{C}$  to  $85^{\circ}\text{C}$  (unless otherwise noted)

PARAMETER	TEST CONDITIONS	$T_A$	LM4040C82I			LM4040D82I			UNIT
			MIN	TYP	MAX	MIN	TYP	MAX	
$V_Z$	Reverse breakdown voltage	$I_Z = 150\ \mu\text{A}$	25°C			8.192			V
$\Delta V_Z$	Reverse breakdown voltage tolerance	$I_Z = 150\ \mu\text{A}$	25°C			-41      41			mV
			Full range			-94      94			
$I_{Z,\text{min}}$	Minimum cathode current		25°C			67      106			$\mu\text{A}$
			Full range			110			
$\alpha_{VZ}$	Average temperature coefficient of reverse breakdown voltage	$I_Z = 10\ \text{mA}$	25°C			$\pm 40$			ppm/°C
		$I_Z = 1\ \text{mA}$	25°C			$\pm 20$			
			Full range			$\pm 100$			
$\frac{\Delta V_Z}{\Delta I_Z}$	Reverse breakdown voltage change with cathode current change	$I_{Z,\text{min}} < I_Z < 1\ \text{mA}$	25°C			0.6      1.3			mV
			Full range			2.5			
		$1\ \text{mA} < I_Z < 15\ \text{mA}$	25°C			7      10			
			Full range			18			
$Z_Z$	Reverse dynamic impedance	$I_Z = 1\ \text{mA}$ , $f = 120\ \text{Hz}$ , $I_{\text{AC}} = 0.1 I_Z$	25°C			0.6      1.5			$\Omega$
$e_N$	Wideband noise	$I_Z = 150\ \mu\text{A}$ , $10\ \text{Hz} \leq f \leq 10\ \text{kHz}$	25°C			130			$\mu\text{V}_{\text{RMS}}$
	Long-term stability of reverse breakdown voltage	$t = 1000\ \text{h}$ , $T_A = 25^{\circ}\text{C} \pm 0.1^{\circ}\text{C}$ , $I_Z = 150\ \mu\text{A}$				120			ppm
$V_{\text{HYST}}$	Thermal hysteresis <sup>(1)</sup>	$\Delta T_A = -40^{\circ}\text{C}$ to $125^{\circ}\text{C}$				0.08			%

(1) Thermal hysteresis is defined as  $V_{Z,25^{\circ}\text{C}}$  (after cycling to  $-40^{\circ}\text{C}$ ) –  $V_{Z,25^{\circ}\text{C}}$  (after cycling to  $125^{\circ}\text{C}$ ).

# LM4040 PRECISION MICROPOWER SHUNT VOLTAGE REFERENCE

SLOS456J – JANUARY 2005 – REVISED SEPTEMBER 2006

## LM4040x10I Electrical Characteristics

at industrial temperature range, full-range  $T_A = -40^{\circ}\text{C}$  to  $85^{\circ}\text{C}$  (unless otherwise noted)

PARAMETER	TEST CONDITIONS	$T_A$	LM4040A10I			LM4040B10I			UNIT
			MIN	TYP	MAX	MIN	TYP	MAX	
$V_Z$	Reverse breakdown voltage	$I_Z = 150\ \mu\text{A}$	25°C			10			V
$\Delta V_Z$	Reverse breakdown voltage tolerance	$I_Z = 150\ \mu\text{A}$	25°C			-10      10			mV
			Full range			-75      75			
$I_{Z,\text{min}}$	Minimum cathode current		25°C			75      120			$\mu\text{A}$
			Full range			125      125			
$\alpha_{VZ}$	Average temperature coefficient of reverse breakdown voltage	$I_Z = 10\ \text{mA}$	25°C			$\pm 40$			ppm/°C
		$I_Z = 1\ \text{mA}$	25°C			$\pm 20$			
			Full range			$\pm 100$			
$\frac{\Delta V_Z}{\Delta I_Z}$	Reverse breakdown voltage change with cathode current change	$I_{Z,\text{min}} < I_Z < 1\ \text{mA}$	25°C			0.8      1.5			mV
			Full range			3.5      3.5			
		$1\ \text{mA} < I_Z < 15\ \text{mA}$	25°C			8      14			
			Full range			24      24			
$Z_Z$	Reverse dynamic impedance	$I_Z = 1\ \text{mA}$ , $f = 120\ \text{Hz}$ , $I_{\text{AC}} = 0.1 I_Z$	25°C			0.7      1.7			$\Omega$
$e_N$	Wideband noise	$I_Z = 150\ \mu\text{A}$ , $10\ \text{Hz} \leq f \leq 10\ \text{kHz}$	25°C			180			$\mu\text{V}_{\text{RMS}}$
	Long-term stability of reverse breakdown voltage	$t = 1000\ \text{h}$ , $T_A = 25^{\circ}\text{C} \pm 0.1^{\circ}\text{C}$ , $I_Z = 150\ \mu\text{A}$				120			ppm
$V_{\text{HYST}}$	Thermal hysteresis <sup>(1)</sup>	$\Delta T_A = -40^{\circ}\text{C}$ to $125^{\circ}\text{C}$				0.08			%

(1) Thermal hysteresis is defined as  $V_{Z,25^{\circ}\text{C}}$  (after cycling to  $-40^{\circ}\text{C}$ ) –  $V_{Z,25^{\circ}\text{C}}$  (after cycling to  $125^{\circ}\text{C}$ ).



### LM4040x10I Electrical Characteristics

at industrial temperature range, full-range  $T_A = -40^\circ\text{C}$  to  $85^\circ\text{C}$  (unless otherwise noted)

PARAMETER	TEST CONDITIONS	$T_A$	LM4040C10I			LM4040D10I			UNIT
			MIN	TYP	MAX	MIN	TYP	MAX	
$V_Z$	Reverse breakdown voltage	$I_Z = 150\ \mu\text{A}$	25°C			10			V
$\Delta V_Z$	Reverse breakdown voltage tolerance	$I_Z = 150\ \mu\text{A}$	25°C			-50                      50			mV
			Full range			-115                      115			
$I_{Z,\text{min}}$	Minimum cathode current		25°C			75      120			$\mu\text{A}$
			Full range			125                      135			
$\alpha_{VZ}$	Average temperature coefficient of reverse breakdown voltage	$I_Z = 10\ \text{mA}$	25°C			$\pm 40$			ppm/°C
		$I_Z = 1\ \text{mA}$	25°C			$\pm 20$			
			Full range			$\pm 100$			
$\frac{\Delta V_Z}{\Delta I_Z}$	Reverse breakdown voltage change with cathode current change	$I_{Z,\text{min}} < I_Z < 1\ \text{mA}$	25°C			0.8      1.5                      0.8      2			mV
			Full range			3.5                      4			
		$1\ \text{mA} < I_Z < 15\ \text{mA}$	25°C			8      14                      8      18			
			Full range			24                      29			
$Z_Z$	Reverse dynamic impedance	$I_Z = 1\ \text{mA}$ , $f = 120\ \text{Hz}$ , $I_{\text{AC}} = 0.1 I_Z$	25°C			0.7      1.7                      0.7      2.3			$\Omega$
$e_N$	Wideband noise	$I_Z = 150\ \mu\text{A}$ , $10\ \text{Hz} \leq f \leq 10\ \text{kHz}$	25°C			180			$\mu\text{V}_{\text{RMS}}$
	Long-term stability of reverse breakdown voltage	$t = 1000\ \text{h}$ , $T_A = 25^\circ\text{C} \pm 0.1^\circ\text{C}$ , $I_Z = 150\ \mu\text{A}$				120			ppm
$V_{\text{HYST}}$	Thermal hysteresis <sup>(1)</sup>	$\Delta T_A = -40^\circ\text{C}$ to $125^\circ\text{C}$				0.08			%

(1) Thermal hysteresis is defined as  $V_{Z,25^\circ\text{C}}$  (after cycling to  $-40^\circ\text{C}$ ) –  $V_{Z,25^\circ\text{C}}$  (after cycling to  $125^\circ\text{C}$ ).

**TYPICAL CHARACTERISTICS**

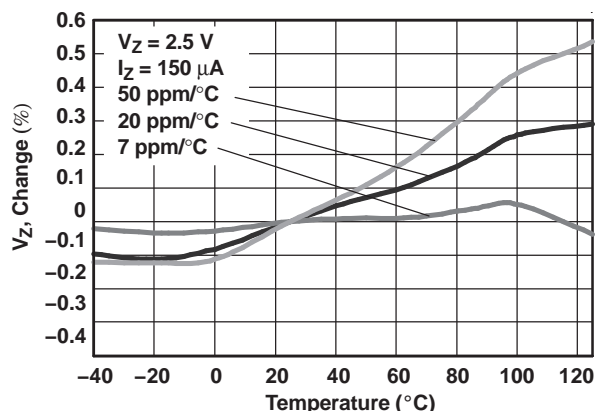

Figure 1. Temperature Drift for Different Average Temperature Coefficients

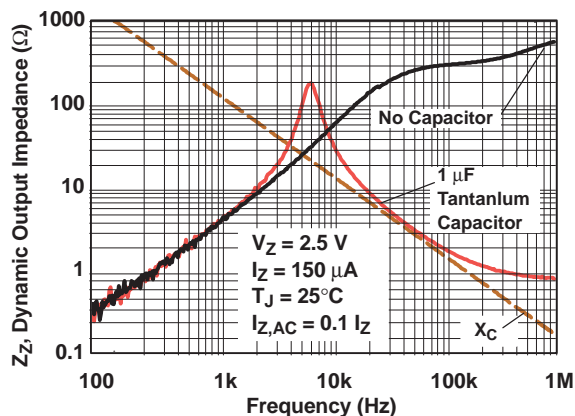

Figure 2. Output Impedance vs Frequency

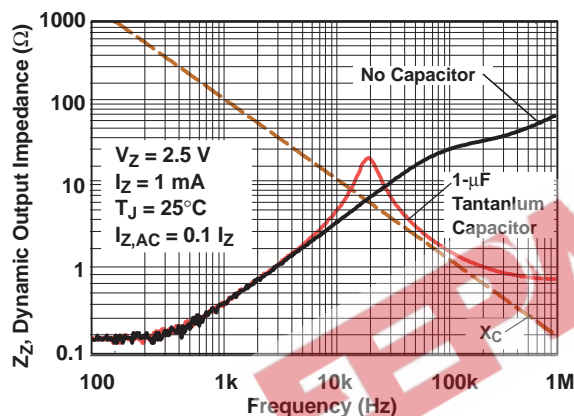

Figure 3. Output Impedance vs Frequency

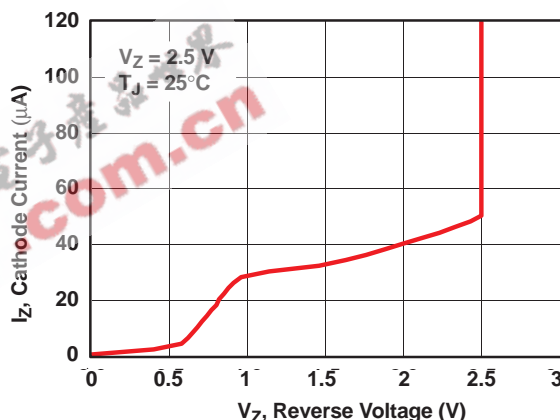

Figure 4. Temperature Drift for Different Average Temperature Coefficient

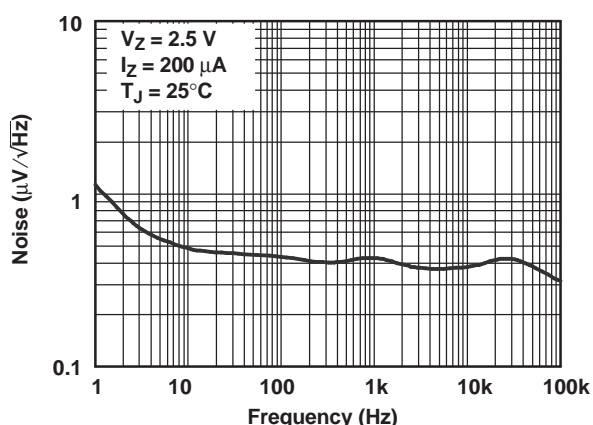

Figure 5. Noise Voltage vs Frequency

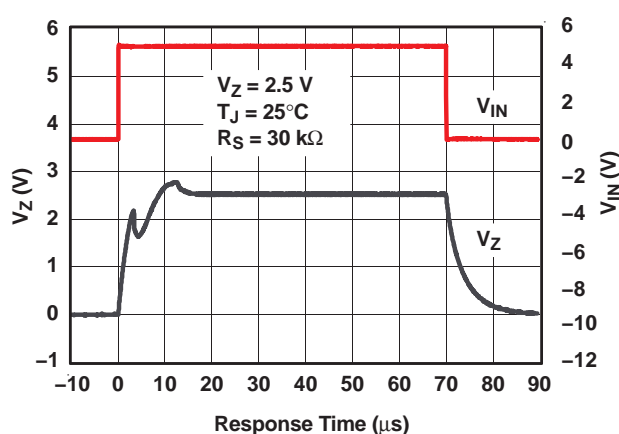
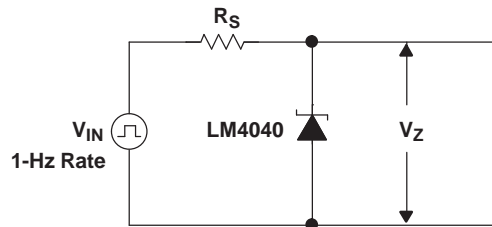

Figure 6. Start-Up Characteristics

## APPLICATION INFORMATION

### Start-Up Characteristics



**Figure 7. Test Circuit**

### Output Capacitor

The LM4040 does not require an output capacitor across cathode and anode for stability. However, if an output bypass capacitor is desired, the LM4040 is designed to be stable with all capacitive loads.

### SOT-23 Connections

There is a parasitic Schottky diode connected between pins 2 and 3 of the SOT-23 packaged device. Thus, pin 3 of the SOT-23 package must be left floating or connected to pin 2.

### Use With ADCs or DACs

The LM4040x-41 is designed to be a cost-effective voltage reference as required in 12-bit data-acquisition systems. For 12-bit systems operating from 5-V supplies such as the ADS7842 (see Figure 8), the LM4040x-41 (4.096 V) permits operation with an LSB of 1 mV.

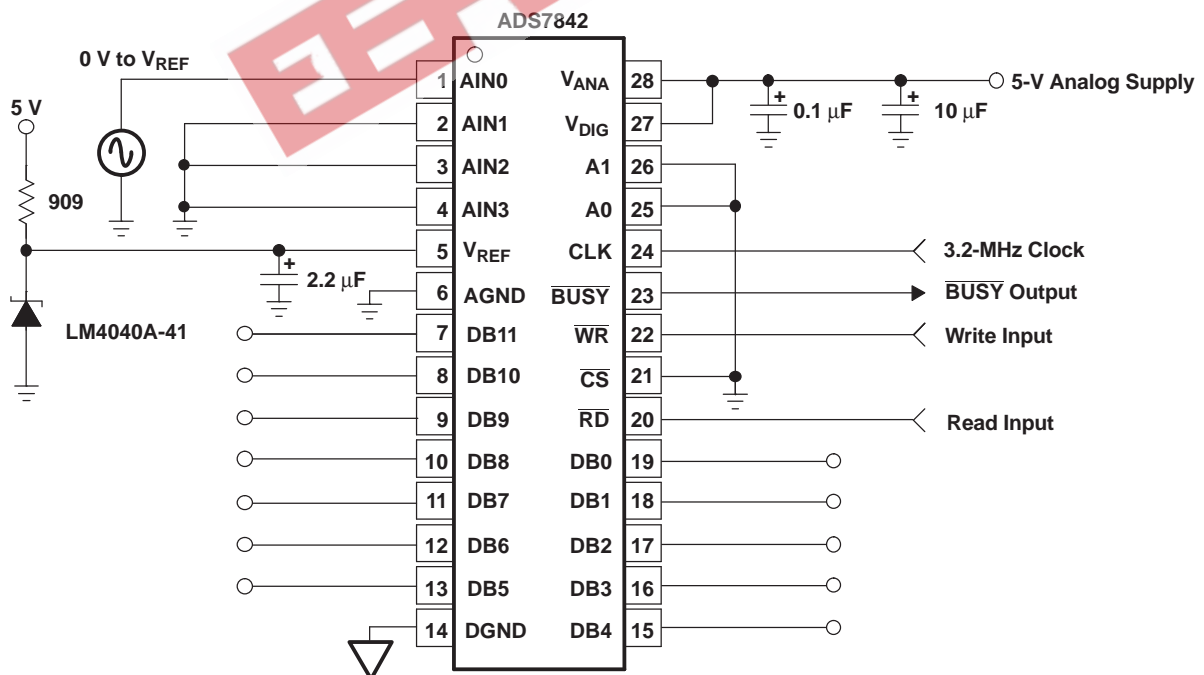

**Figure 8. Data-Acquisition Circuit With LM4040x-41**

APPLICATION INFORMATION (continued)

Cathode and Load Currents

In a typical shunt-regulator configuration (see Figure 9), an external resistor,  $R_S$ , is connected between the supply and the cathode of the LM4040.  $R_S$  must be set properly, as it sets the total current available to supply the load ( $I_L$ ) and bias the LM4040 ( $I_Z$ ). In all cases,  $I_Z$  must stay within a specified range for proper operation of the reference. Taking into consideration one extreme in the variation of the load and supply voltage (maximum  $I_L$  and minimum  $V_S$ ),  $R_S$  must be small enough to supply the minimum  $I_Z$  required for operation of the regulator, as given by data-sheet parameters. At the other extreme, maximum  $V_S$  and minimum  $I_L$ ,  $R_S$  must be large enough to limit  $I_Z$  to less than its maximum-rated value of 15 mA.

$R_S$  is calculated according to Equation 1:

$$R_S = \frac{(V_S - V_Z)}{(I_L + I_Z)} \quad (1)$$

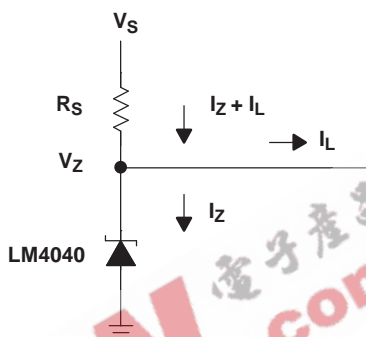

Figure 9. Shunt Regulator

**PACKAGING INFORMATION**

Orderable Device	Status <sup>(1)</sup>	Package Type	Package Drawing	Pins	Package Qty	Eco Plan <sup>(2)</sup>	Lead/Ball Finish	MSL Peak Temp <sup>(3)</sup>
LM4040A10IDBZR	ACTIVE	SOT-23	DBZ	3	3000	Green (RoHS & no Sb/Br)	CU NIPDAU	Level-1-260C-UNLIM
LM4040A10IDBZRG4	ACTIVE	SOT-23	DBZ	3	3000	Green (RoHS & no Sb/Br)	CU NIPDAU	Level-1-260C-UNLIM
LM4040A10IDBZT	ACTIVE	SOT-23	DBZ	3	250	Green (RoHS & no Sb/Br)	CU NIPDAU	Level-1-260C-UNLIM
LM4040A10IDBZTG4	ACTIVE	SOT-23	DBZ	3	250	Green (RoHS & no Sb/Br)	CU NIPDAU	Level-1-260C-UNLIM
LM4040A10IDCKR	ACTIVE	SC70	DCK	5	3000	Green (RoHS & no Sb/Br)	CU NIPDAU	Level-1-260C-UNLIM
LM4040A10IDCKRG4	ACTIVE	SC70	DCK	5	3000	Green (RoHS & no Sb/Br)	CU NIPDAU	Level-1-260C-UNLIM
LM4040A10ILP	PREVIEW	TO-92	LP	3	1000	TBD	Call TI	Call TI
LM4040A10ILPR	PREVIEW	TO-92	LP	3	2000	TBD	Call TI	Call TI
LM4040A20IDBZR	ACTIVE	SOT-23	DBZ	3	3000	Green (RoHS & no Sb/Br)	CU NIPDAU	Level-1-260C-UNLIM
LM4040A20IDBZRG4	ACTIVE	SOT-23	DBZ	3	3000	Green (RoHS & no Sb/Br)	CU NIPDAU	Level-1-260C-UNLIM
LM4040A20IDBZT	ACTIVE	SOT-23	DBZ	3	250	Green (RoHS & no Sb/Br)	CU NIPDAU	Level-1-260C-UNLIM
LM4040A20IDBZTG4	ACTIVE	SOT-23	DBZ	3	250	Green (RoHS & no Sb/Br)	CU NIPDAU	Level-1-260C-UNLIM
LM4040A20IDCKR	ACTIVE	SC70	DCK	5	3000	Green (RoHS & no Sb/Br)	CU NIPDAU	Level-1-260C-UNLIM
LM4040A20IDCKRE4	ACTIVE	SC70	DCK	5	3000	Green (RoHS & no Sb/Br)	CU NIPDAU	Level-1-260C-UNLIM
LM4040A20IDCKRG4	ACTIVE	SC70	DCK	5	3000	Green (RoHS & no Sb/Br)	CU NIPDAU	Level-1-260C-UNLIM
LM4040A25IDBZR	ACTIVE	SOT-23	DBZ	3	3000	Green (RoHS & no Sb/Br)	CU NIPDAU	Level-1-260C-UNLIM
LM4040A25IDBZRG4	ACTIVE	SOT-23	DBZ	3	3000	Green (RoHS & no Sb/Br)	CU NIPDAU	Level-1-260C-UNLIM
LM4040A25IDBZT	ACTIVE	SOT-23	DBZ	3	250	Green (RoHS & no Sb/Br)	CU NIPDAU	Level-1-260C-UNLIM
LM4040A25IDBZTG4	ACTIVE	SOT-23	DBZ	3	250	Green (RoHS & no Sb/Br)	CU NIPDAU	Level-1-260C-UNLIM
LM4040A25IDCKR	ACTIVE	SC70	DCK	5	3000	Green (RoHS & no Sb/Br)	CU NIPDAU	Level-1-260C-UNLIM
LM4040A25IDCKRE4	ACTIVE	SC70	DCK	5	3000	Green (RoHS & no Sb/Br)	CU NIPDAU	Level-1-260C-UNLIM
LM4040A25IDCKRG4	ACTIVE	SC70	DCK	5	3000	Green (RoHS & no Sb/Br)	CU NIPDAU	Level-1-260C-UNLIM
LM4040A25ILP	PREVIEW	TO-92	LP	3	1000	TBD	Call TI	Call TI
LM4040A25ILPR	PREVIEW	TO-92	LP	3	2000	TBD	Call TI	Call TI
LM4040A30IDBZR	ACTIVE	SOT-23	DBZ	3	3000	Green (RoHS & no Sb/Br)	CU NIPDAU	Level-1-260C-UNLIM
LM4040A30IDBZRG4	ACTIVE	SOT-23	DBZ	3	3000	Green (RoHS & no Sb/Br)	CU NIPDAU	Level-1-260C-UNLIM
LM4040A30IDBZT	ACTIVE	SOT-23	DBZ	3	250	Green (RoHS & no Sb/Br)	CU NIPDAU	Level-1-260C-UNLIM

Orderable Device	Status <sup>(1)</sup>	Package Type	Package Drawing	Pins	Package Qty	Eco Plan <sup>(2)</sup>	Lead/Ball Finish	MSL Peak Temp <sup>(3)</sup>
						no Sb/Br)		
LM4040A30IDBZTG4	ACTIVE	SOT-23	DBZ	3	250	Green (RoHS & no Sb/Br)	CU NIPDAU	Level-1-260C-UNLIM
LM4040A30IDCKR	ACTIVE	SC70	DCK	5	3000	Green (RoHS & no Sb/Br)	CU NIPDAU	Level-1-260C-UNLIM
LM4040A30IDCKRE4	ACTIVE	SC70	DCK	5	3000	Green (RoHS & no Sb/Br)	CU NIPDAU	Level-1-260C-UNLIM
LM4040A30IDCKRG4	ACTIVE	SC70	DCK	5	3000	Green (RoHS & no Sb/Br)	CU NIPDAU	Level-1-260C-UNLIM
LM4040A30IDCKT	PREVIEW	SC70	DCK	5	250	TBD	Call TI	Call TI
LM4040A30ILP	PREVIEW	TO-92	LP	3	1000	TBD	Call TI	Call TI
LM4040A30ILPM	PREVIEW	TO-92	LP	3	2000	TBD	Call TI	Call TI
LM4040A30ILPR	PREVIEW	TO-92	LP	3	2000	TBD	Call TI	Call TI
LM4040A41IDBZR	ACTIVE	SOT-23	DBZ	3	3000	Green (RoHS & no Sb/Br)	CU NIPDAU	Level-1-260C-UNLIM
LM4040A41IDBZRG4	ACTIVE	SOT-23	DBZ	3	3000	Green (RoHS & no Sb/Br)	CU NIPDAU	Level-1-260C-UNLIM
LM4040A41IDBZT	ACTIVE	SOT-23	DBZ	3	250	Green (RoHS & no Sb/Br)	CU NIPDAU	Level-1-260C-UNLIM
LM4040A41IDBZTG4	ACTIVE	SOT-23	DBZ	3	250	Green (RoHS & no Sb/Br)	CU NIPDAU	Level-1-260C-UNLIM
LM4040A41IDCKR	ACTIVE	SC70	DCK	5	3000	Green (RoHS & no Sb/Br)	CU NIPDAU	Level-1-260C-UNLIM
LM4040A41IDCKRE4	ACTIVE	SC70	DCK	5	3000	Green (RoHS & no Sb/Br)	CU NIPDAU	Level-1-260C-UNLIM
LM4040A41IDCKRG4	ACTIVE	SC70	DCK	5	3000	Green (RoHS & no Sb/Br)	CU NIPDAU	Level-1-260C-UNLIM
LM4040A41ILP	PREVIEW	TO-92	LP	3	1000	TBD	Call TI	Call TI
LM4040A41ILPR	PREVIEW	TO-92	LP	3	2000	TBD	Call TI	Call TI
LM4040A50IDBZR	ACTIVE	SOT-23	DBZ	3	3000	Green (RoHS & no Sb/Br)	CU NIPDAU	Level-1-260C-UNLIM
LM4040A50IDBZRG4	ACTIVE	SOT-23	DBZ	3	3000	Green (RoHS & no Sb/Br)	CU NIPDAU	Level-1-260C-UNLIM
LM4040A50IDBZT	ACTIVE	SOT-23	DBZ	3	250	Green (RoHS & no Sb/Br)	CU NIPDAU	Level-1-260C-UNLIM
LM4040A50IDBZTG4	ACTIVE	SOT-23	DBZ	3	250	Green (RoHS & no Sb/Br)	CU NIPDAU	Level-1-260C-UNLIM
LM4040A50IDCKR	ACTIVE	SC70	DCK	5	3000	Green (RoHS & no Sb/Br)	CU NIPDAU	Level-1-260C-UNLIM
LM4040A50IDCKRE4	ACTIVE	SC70	DCK	5	3000	Green (RoHS & no Sb/Br)	CU NIPDAU	Level-1-260C-UNLIM
LM4040A50IDCKRG4	ACTIVE	SC70	DCK	5	3000	Green (RoHS & no Sb/Br)	CU NIPDAU	Level-1-260C-UNLIM
LM4040A50ILP	PREVIEW	TO-92	LP	3	1000	TBD	Call TI	Call TI
LM4040A82IDBZR	ACTIVE	SOT-23	DBZ	3	3000	Green (RoHS & no Sb/Br)	CU NIPDAU	Level-1-260C-UNLIM
LM4040A82IDBZRG4	ACTIVE	SOT-23	DBZ	3	3000	Green (RoHS & no Sb/Br)	CU NIPDAU	Level-1-260C-UNLIM
LM4040A82IDBZT	ACTIVE	SOT-23	DBZ	3	250	Green (RoHS & no Sb/Br)	CU NIPDAU	Level-1-260C-UNLIM

Orderable Device	Status <sup>(1)</sup>	Package Type	Package Drawing	Pins	Package Qty	Eco Plan <sup>(2)</sup>	Lead/Ball Finish	MSL Peak Temp <sup>(3)</sup>
LM4040A82IDBZTG4	ACTIVE	SOT-23	DBZ	3	250	Green (RoHS & no Sb/Br)	CU NIPDAU	Level-1-260C-UNLIM
LM4040A82IDCKR	ACTIVE	SC70	DCK	5	3000	Green (RoHS & no Sb/Br)	CU NIPDAU	Level-1-260C-UNLIM
LM4040A82IDCKRG4	ACTIVE	SC70	DCK	5	3000	Green (RoHS & no Sb/Br)	CU NIPDAU	Level-1-260C-UNLIM
LM4040B10IDBZR	ACTIVE	SOT-23	DBZ	3	3000	Green (RoHS & no Sb/Br)	CU NIPDAU	Level-1-260C-UNLIM
LM4040B10IDBZRG4	ACTIVE	SOT-23	DBZ	3	3000	Green (RoHS & no Sb/Br)	CU NIPDAU	Level-1-260C-UNLIM
LM4040B10IDBZT	ACTIVE	SOT-23	DBZ	3	250	Green (RoHS & no Sb/Br)	CU NIPDAU	Level-1-260C-UNLIM
LM4040B10IDBZTG4	ACTIVE	SOT-23	DBZ	3	250	Green (RoHS & no Sb/Br)	CU NIPDAU	Level-1-260C-UNLIM
LM4040B10IDCKR	ACTIVE	SC70	DCK	5	3000	Green (RoHS & no Sb/Br)	CU NIPDAU	Level-1-260C-UNLIM
LM4040B10IDCKRG4	ACTIVE	SC70	DCK	5	3000	Green (RoHS & no Sb/Br)	CU NIPDAU	Level-1-260C-UNLIM
LM4040B10ILP	PREVIEW	TO-92	LP	3	1000	TBD	Call TI	Call TI
LM4040B10ILPR	PREVIEW	TO-92	LP	3	2000	TBD	Call TI	Call TI
LM4040B20IDBZR	ACTIVE	SOT-23	DBZ	3	3000	Green (RoHS & no Sb/Br)	CU NIPDAU	Level-1-260C-UNLIM
LM4040B20IDBZRG4	ACTIVE	SOT-23	DBZ	3	3000	Green (RoHS & no Sb/Br)	CU NIPDAU	Level-1-260C-UNLIM
LM4040B20IDBZT	ACTIVE	SOT-23	DBZ	3	250	Green (RoHS & no Sb/Br)	CU NIPDAU	Level-1-260C-UNLIM
LM4040B20IDBZTG4	ACTIVE	SOT-23	DBZ	3	250	Green (RoHS & no Sb/Br)	CU NIPDAU	Level-1-260C-UNLIM
LM4040B20IDCKR	ACTIVE	SC70	DCK	5	3000	Green (RoHS & no Sb/Br)	CU NIPDAU	Level-1-260C-UNLIM
LM4040B20IDCKRE4	ACTIVE	SC70	DCK	5	3000	Green (RoHS & no Sb/Br)	CU NIPDAU	Level-1-260C-UNLIM
LM4040B20IDCKRG4	ACTIVE	SC70	DCK	5	3000	Green (RoHS & no Sb/Br)	CU NIPDAU	Level-1-260C-UNLIM
LM4040B25IDBZR	ACTIVE	SOT-23	DBZ	3	3000	Green (RoHS & no Sb/Br)	CU NIPDAU	Level-1-260C-UNLIM
LM4040B25IDBZRG4	ACTIVE	SOT-23	DBZ	3	3000	Green (RoHS & no Sb/Br)	CU NIPDAU	Level-1-260C-UNLIM
LM4040B25IDBZT	ACTIVE	SOT-23	DBZ	3	250	Green (RoHS & no Sb/Br)	CU NIPDAU	Level-1-260C-UNLIM
LM4040B25IDBZTG4	ACTIVE	SOT-23	DBZ	3	250	Green (RoHS & no Sb/Br)	CU NIPDAU	Level-1-260C-UNLIM
LM4040B25IDCKR	ACTIVE	SC70	DCK	5	3000	Green (RoHS & no Sb/Br)	CU NIPDAU	Level-1-260C-UNLIM
LM4040B25IDCKRE4	ACTIVE	SC70	DCK	5	3000	Green (RoHS & no Sb/Br)	CU NIPDAU	Level-1-260C-UNLIM
LM4040B25IDCKRG4	ACTIVE	SC70	DCK	5	3000	Green (RoHS & no Sb/Br)	CU NIPDAU	Level-1-260C-UNLIM
LM4040B25ILP	PREVIEW	TO-92	LP	3	1000	TBD	Call TI	Call TI
LM4040B25ILPR	PREVIEW	TO-92	LP	3	2000	TBD	Call TI	Call TI
LM4040B30IDBZR	ACTIVE	SOT-23	DBZ	3	3000	Green (RoHS & no Sb/Br)	CU NIPDAU	Level-1-260C-UNLIM

Orderable Device	Status <sup>(1)</sup>	Package Type	Package Drawing	Pins	Package Qty	Eco Plan <sup>(2)</sup>	Lead/Ball Finish	MSL Peak Temp <sup>(3)</sup>
						no Sb/Br)		
LM4040B30IDBZRG4	ACTIVE	SOT-23	DBZ	3	3000	Green (RoHS & no Sb/Br)	CU NIPDAU	Level-1-260C-UNLIM
LM4040B30IDBZT	ACTIVE	SOT-23	DBZ	3	250	Green (RoHS & no Sb/Br)	CU NIPDAU	Level-1-260C-UNLIM
LM4040B30IDBZTG4	ACTIVE	SOT-23	DBZ	3	250	Green (RoHS & no Sb/Br)	CU NIPDAU	Level-1-260C-UNLIM
LM4040B30IDCKR	ACTIVE	SC70	DCK	5	3000	Green (RoHS & no Sb/Br)	CU NIPDAU	Level-1-260C-UNLIM
LM4040B30IDCKRE4	ACTIVE	SC70	DCK	5	3000	Green (RoHS & no Sb/Br)	CU NIPDAU	Level-1-260C-UNLIM
LM4040B30IDCKRG4	ACTIVE	SC70	DCK	5	3000	Green (RoHS & no Sb/Br)	CU NIPDAU	Level-1-260C-UNLIM
LM4040B30IDCKT	PREVIEW	SC70	DCK	5	250	TBD	Call TI	Call TI
LM4040B30ILP	PREVIEW	TO-92	LP	3	1000	TBD	Call TI	Call TI
LM4040B30ILPM	PREVIEW	TO-92	LP	3	2000	TBD	Call TI	Call TI
LM4040B30ILPR	PREVIEW	TO-92	LP	3	2000	TBD	Call TI	Call TI
LM4040B41IDBZR	ACTIVE	SOT-23	DBZ	3	3000	Green (RoHS & no Sb/Br)	CU NIPDAU	Level-1-260C-UNLIM
LM4040B41IDBZRG4	ACTIVE	SOT-23	DBZ	3	3000	Green (RoHS & no Sb/Br)	CU NIPDAU	Level-1-260C-UNLIM
LM4040B41IDBZT	ACTIVE	SOT-23	DBZ	3	250	Green (RoHS & no Sb/Br)	CU NIPDAU	Level-1-260C-UNLIM
LM4040B41IDBZTG4	ACTIVE	SOT-23	DBZ	3	250	Green (RoHS & no Sb/Br)	CU NIPDAU	Level-1-260C-UNLIM
LM4040B41IDCKR	ACTIVE	SC70	DCK	5	3000	Green (RoHS & no Sb/Br)	CU NIPDAU	Level-1-260C-UNLIM
LM4040B41IDCKRE4	ACTIVE	SC70	DCK	5	3000	Green (RoHS & no Sb/Br)	CU NIPDAU	Level-1-260C-UNLIM
LM4040B41IDCKRG4	ACTIVE	SC70	DCK	5	3000	Green (RoHS & no Sb/Br)	CU NIPDAU	Level-1-260C-UNLIM
LM4040B41ILP	PREVIEW	TO-92	LP	3	1000	TBD	Call TI	Call TI
LM4040B41ILPR	PREVIEW	TO-92	LP	3	2000	TBD	Call TI	Call TI
LM4040B50IDBZR	ACTIVE	SOT-23	DBZ	3	3000	Green (RoHS & no Sb/Br)	CU NIPDAU	Level-1-260C-UNLIM
LM4040B50IDBZRG4	ACTIVE	SOT-23	DBZ	3	3000	Green (RoHS & no Sb/Br)	CU NIPDAU	Level-1-260C-UNLIM
LM4040B50IDBZT	ACTIVE	SOT-23	DBZ	3	250	Green (RoHS & no Sb/Br)	CU NIPDAU	Level-1-260C-UNLIM
LM4040B50IDBZTG4	ACTIVE	SOT-23	DBZ	3	250	Green (RoHS & no Sb/Br)	CU NIPDAU	Level-1-260C-UNLIM
LM4040B50IDCKR	ACTIVE	SC70	DCK	5	3000	Green (RoHS & no Sb/Br)	CU NIPDAU	Level-1-260C-UNLIM
LM4040B50IDCKRE4	ACTIVE	SC70	DCK	5	3000	Green (RoHS & no Sb/Br)	CU NIPDAU	Level-1-260C-UNLIM
LM4040B50IDCKRG4	ACTIVE	SC70	DCK	5	3000	Green (RoHS & no Sb/Br)	CU NIPDAU	Level-1-260C-UNLIM
LM4040B50ILP	PREVIEW	TO-92	LP	3	1000	TBD	Call TI	Call TI
LM4040B50ILPR	PREVIEW	TO-92	LP	3	2000	TBD	Call TI	Call TI
LM4040B82IDBZR	ACTIVE	SOT-23	DBZ	3	3000	Green (RoHS & no Sb/Br)	CU NIPDAU	Level-1-260C-UNLIM



Orderable Device	Status <sup>(1)</sup>	Package Type	Package Drawing	Pins	Package Qty	Eco Plan <sup>(2)</sup>	Lead/Ball Finish	MSL Peak Temp <sup>(3)</sup>
						no Sb/Br)		
LM4040B82IDBZRG4	ACTIVE	SOT-23	DBZ	3	3000	Green (RoHS & no Sb/Br)	CU NIPDAU	Level-1-260C-UNLIM
LM4040B82IDBZT	ACTIVE	SOT-23	DBZ	3	250	Green (RoHS & no Sb/Br)	CU NIPDAU	Level-1-260C-UNLIM
LM4040B82IDBZTG4	ACTIVE	SOT-23	DBZ	3	250	Green (RoHS & no Sb/Br)	CU NIPDAU	Level-1-260C-UNLIM
LM4040B82IDCKR	ACTIVE	SC70	DCK	5	3000	Green (RoHS & no Sb/Br)	CU NIPDAU	Level-1-260C-UNLIM
LM4040B82IDCKRG4	ACTIVE	SC70	DCK	5	3000	Green (RoHS & no Sb/Br)	CU NIPDAU	Level-1-260C-UNLIM
LM4040C10IDBZR	ACTIVE	SOT-23	DBZ	3	3000	Green (RoHS & no Sb/Br)	CU NIPDAU	Level-1-260C-UNLIM
LM4040C10IDBZRG4	ACTIVE	SOT-23	DBZ	3	3000	Green (RoHS & no Sb/Br)	CU NIPDAU	Level-1-260C-UNLIM
LM4040C10IDBZT	ACTIVE	SOT-23	DBZ	3	250	Green (RoHS & no Sb/Br)	CU NIPDAU	Level-1-260C-UNLIM
LM4040C10IDBZTG4	ACTIVE	SOT-23	DBZ	3	250	Green (RoHS & no Sb/Br)	CU NIPDAU	Level-1-260C-UNLIM
LM4040C10IDCKR	ACTIVE	SC70	DCK	5	3000	Green (RoHS & no Sb/Br)	CU NIPDAU	Level-1-260C-UNLIM
LM4040C10IDCKRG4	ACTIVE	SC70	DCK	5	3000	Green (RoHS & no Sb/Br)	CU NIPDAU	Level-1-260C-UNLIM
LM4040C10ILP	ACTIVE	TO-92	LP	3	1000	Pb-Free (RoHS)	CU SN	N / A for Pkg Type
LM4040C10ILPR	ACTIVE	TO-92	LP	3	2000	Pb-Free (RoHS)	CU SN	N / A for Pkg Type
LM4040C20IDBZR	ACTIVE	SOT-23	DBZ	3	3000	Green (RoHS & no Sb/Br)	CU NIPDAU	Level-1-260C-UNLIM
LM4040C20IDBZRG4	ACTIVE	SOT-23	DBZ	3	3000	Green (RoHS & no Sb/Br)	CU NIPDAU	Level-1-260C-UNLIM
LM4040C20IDBZT	ACTIVE	SOT-23	DBZ	3	250	Green (RoHS & no Sb/Br)	CU NIPDAU	Level-1-260C-UNLIM
LM4040C20IDBZTG4	ACTIVE	SOT-23	DBZ	3	250	Green (RoHS & no Sb/Br)	CU NIPDAU	Level-1-260C-UNLIM
LM4040C20IDCKR	ACTIVE	SC70	DCK	5	3000	Green (RoHS & no Sb/Br)	CU NIPDAU	Level-1-260C-UNLIM
LM4040C20IDCKRE4	ACTIVE	SC70	DCK	5	3000	Green (RoHS & no Sb/Br)	CU NIPDAU	Level-1-260C-UNLIM
LM4040C20IDCKRG4	ACTIVE	SC70	DCK	5	3000	Green (RoHS & no Sb/Br)	CU NIPDAU	Level-1-260C-UNLIM
LM4040C20ILP	ACTIVE	TO-92	LP	3	1000	Pb-Free (RoHS)	CU SN	N / A for Pkg Type
LM4040C20ILPR	ACTIVE	TO-92	LP	3	2000	Pb-Free (RoHS)	CU SN	N / A for Pkg Type
LM4040C20QDBZR	ACTIVE	SOT-23	DBZ	3	3000	Green (RoHS & no Sb/Br)	CU NIPDAU	Level-1-260C-UNLIM
LM4040C20QDBZRG4	ACTIVE	SOT-23	DBZ	3	3000	Green (RoHS & no Sb/Br)	CU NIPDAU	Level-1-260C-UNLIM
LM4040C20QDBZT	ACTIVE	SOT-23	DBZ	3	250	Green (RoHS & no Sb/Br)	CU NIPDAU	Level-1-260C-UNLIM

Orderable Device	Status <sup>(1)</sup>	Package Type	Package Drawing	Pins	Package Qty	Eco Plan <sup>(2)</sup>	Lead/Ball Finish	MSL Peak Temp <sup>(3)</sup>
LM4040C20QDBZTG4	ACTIVE	SOT-23	DBZ	3	250	Green (RoHS & no Sb/Br)	CU NIPDAU	Level-1-260C-UNLIM
LM4040C25IDBZR	ACTIVE	SOT-23	DBZ	3	3000	Green (RoHS & no Sb/Br)	CU NIPDAU	Level-1-260C-UNLIM
LM4040C25IDBZRG4	ACTIVE	SOT-23	DBZ	3	3000	Green (RoHS & no Sb/Br)	CU NIPDAU	Level-1-260C-UNLIM
LM4040C25IDBZT	ACTIVE	SOT-23	DBZ	3	250	Green (RoHS & no Sb/Br)	CU NIPDAU	Level-1-260C-UNLIM
LM4040C25IDBZTG4	ACTIVE	SOT-23	DBZ	3	250	Green (RoHS & no Sb/Br)	CU NIPDAU	Level-1-260C-UNLIM
LM4040C25IDCKR	ACTIVE	SC70	DCK	5	3000	Green (RoHS & no Sb/Br)	CU NIPDAU	Level-1-260C-UNLIM
LM4040C25IDCKRE4	ACTIVE	SC70	DCK	5	3000	Green (RoHS & no Sb/Br)	CU NIPDAU	Level-1-260C-UNLIM
LM4040C25IDCKRG4	ACTIVE	SC70	DCK	5	3000	Green (RoHS & no Sb/Br)	CU NIPDAU	Level-1-260C-UNLIM
LM4040C25IDCKT	ACTIVE	SC70	DCK	5	250	Green (RoHS & no Sb/Br)	CU NIPDAU	Level-1-260C-UNLIM
LM4040C25IDCKTE4	ACTIVE	SC70	DCK	5	250	Green (RoHS & no Sb/Br)	CU NIPDAU	Level-1-260C-UNLIM
LM4040C25IDCKTG4	ACTIVE	SC70	DCK	5	250	Green (RoHS & no Sb/Br)	CU NIPDAU	Level-1-260C-UNLIM
LM4040C25ILP	ACTIVE	TO-92	LP	3	1000	Pb-Free (RoHS)	CU SN	N / A for Pkg Type
LM4040C25ILPR	ACTIVE	TO-92	LP	3	2000	Pb-Free (RoHS)	CU SN	N / A for Pkg Type
LM4040C25QDBZR	ACTIVE	SOT-23	DBZ	3	3000	Green (RoHS & no Sb/Br)	CU NIPDAU	Level-1-260C-UNLIM
LM4040C25QDBZRG4	ACTIVE	SOT-23	DBZ	3	3000	Green (RoHS & no Sb/Br)	CU NIPDAU	Level-1-260C-UNLIM
LM4040C25QDBZT	ACTIVE	SOT-23	DBZ	3	250	Green (RoHS & no Sb/Br)	CU NIPDAU	Level-1-260C-UNLIM
LM4040C25QDBZTG4	ACTIVE	SOT-23	DBZ	3	250	Green (RoHS & no Sb/Br)	CU NIPDAU	Level-1-260C-UNLIM
LM4040C30IDBZR	ACTIVE	SOT-23	DBZ	3	3000	Green (RoHS & no Sb/Br)	CU NIPDAU	Level-1-260C-UNLIM
LM4040C30IDBZRG4	ACTIVE	SOT-23	DBZ	3	3000	Green (RoHS & no Sb/Br)	CU NIPDAU	Level-1-260C-UNLIM
LM4040C30IDBZT	ACTIVE	SOT-23	DBZ	3	250	Green (RoHS & no Sb/Br)	CU NIPDAU	Level-1-260C-UNLIM
LM4040C30IDBZTG4	ACTIVE	SOT-23	DBZ	3	250	Green (RoHS & no Sb/Br)	CU NIPDAU	Level-1-260C-UNLIM
LM4040C30IDCKR	ACTIVE	SC70	DCK	5	3000	Green (RoHS & no Sb/Br)	CU NIPDAU	Level-1-260C-UNLIM
LM4040C30IDCKRE4	ACTIVE	SC70	DCK	5	3000	Green (RoHS & no Sb/Br)	CU NIPDAU	Level-1-260C-UNLIM
LM4040C30IDCKRG4	ACTIVE	SC70	DCK	5	3000	Green (RoHS & no Sb/Br)	CU NIPDAU	Level-1-260C-UNLIM
LM4040C30IDCKT	PREVIEW	SC70	DCK	5	250	TBD	Call TI	Call TI
LM4040C30ILP	ACTIVE	TO-92	LP	3	1000	Pb-Free (RoHS)	CU SN	N / A for Pkg Type

Orderable Device	Status <sup>(1)</sup>	Package Type	Package Drawing	Pins	Package Qty	Eco Plan <sup>(2)</sup>	Lead/Ball Finish	MSL Peak Temp <sup>(3)</sup>
LM4040C30ILPM	PREVIEW	TO-92	LP	3	2000	TBD	Call TI	Call TI
LM4040C30ILPR	ACTIVE	TO-92	LP	3	2000	Pb-Free (RoHS)	CU SN	N / A for Pkg Type
LM4040C30QDBZR	ACTIVE	SOT-23	DBZ	3	3000	Green (RoHS & no Sb/Br)	CU NIPDAU	Level-1-260C-UNLIM
LM4040C30QDBZRG4	ACTIVE	SOT-23	DBZ	3	3000	Green (RoHS & no Sb/Br)	CU NIPDAU	Level-1-260C-UNLIM
LM4040C30QDBZT	ACTIVE	SOT-23	DBZ	3	250	Green (RoHS & no Sb/Br)	CU NIPDAU	Level-1-260C-UNLIM
LM4040C30QDBZTG4	ACTIVE	SOT-23	DBZ	3	250	Green (RoHS & no Sb/Br)	CU NIPDAU	Level-1-260C-UNLIM
LM4040C41IDBZR	ACTIVE	SOT-23	DBZ	3	3000	Green (RoHS & no Sb/Br)	CU NIPDAU	Level-1-260C-UNLIM
LM4040C41IDBZRG4	ACTIVE	SOT-23	DBZ	3	3000	Green (RoHS & no Sb/Br)	CU NIPDAU	Level-1-260C-UNLIM
LM4040C41IDBZT	ACTIVE	SOT-23	DBZ	3	250	Green (RoHS & no Sb/Br)	CU NIPDAU	Level-1-260C-UNLIM
LM4040C41IDBZTG4	ACTIVE	SOT-23	DBZ	3	250	Green (RoHS & no Sb/Br)	CU NIPDAU	Level-1-260C-UNLIM
LM4040C41IDCKR	ACTIVE	SC70	DCK	5	3000	Green (RoHS & no Sb/Br)	CU NIPDAU	Level-1-260C-UNLIM
LM4040C41IDCKRE4	ACTIVE	SC70	DCK	5	3000	Green (RoHS & no Sb/Br)	CU NIPDAU	Level-1-260C-UNLIM
LM4040C41IDCKRG4	ACTIVE	SC70	DCK	5	3000	Green (RoHS & no Sb/Br)	CU NIPDAU	Level-1-260C-UNLIM
LM4040C41ILP	ACTIVE	TO-92	LP	3	1000	Pb-Free (RoHS)	CU SN	N / A for Pkg Type
LM4040C41ILPR	ACTIVE	TO-92	LP	3	2000	Pb-Free (RoHS)	CU SN	N / A for Pkg Type
LM4040C50IDBZR	ACTIVE	SOT-23	DBZ	3	3000	Green (RoHS & no Sb/Br)	CU NIPDAU	Level-1-260C-UNLIM
LM4040C50IDBZRG4	ACTIVE	SOT-23	DBZ	3	3000	Green (RoHS & no Sb/Br)	CU NIPDAU	Level-1-260C-UNLIM
LM4040C50IDBZT	ACTIVE	SOT-23	DBZ	3	250	Green (RoHS & no Sb/Br)	CU NIPDAU	Level-1-260C-UNLIM
LM4040C50IDBZTG4	ACTIVE	SOT-23	DBZ	3	250	Green (RoHS & no Sb/Br)	CU NIPDAU	Level-1-260C-UNLIM
LM4040C50IDCKR	ACTIVE	SC70	DCK	5	3000	Green (RoHS & no Sb/Br)	CU NIPDAU	Level-1-260C-UNLIM
LM4040C50IDCKRE4	ACTIVE	SC70	DCK	5	3000	Green (RoHS & no Sb/Br)	CU NIPDAU	Level-1-260C-UNLIM
LM4040C50IDCKRG4	ACTIVE	SC70	DCK	5	3000	Green (RoHS & no Sb/Br)	CU NIPDAU	Level-1-260C-UNLIM
LM4040C50ILP	ACTIVE	TO-92	LP	3	1000	Pb-Free (RoHS)	CU SN	N / A for Pkg Type
LM4040C50ILPR	ACTIVE	TO-92	LP	3	2000	Pb-Free (RoHS)	CU SN	N / A for Pkg Type
LM4040C50QDBZR	ACTIVE	SOT-23	DBZ	3	3000	Green (RoHS & no Sb/Br)	CU NIPDAU	Level-1-260C-UNLIM
LM4040C50QDBZRG4	ACTIVE	SOT-23	DBZ	3	3000	Green (RoHS & no Sb/Br)	CU NIPDAU	Level-1-260C-UNLIM

Orderable Device	Status <sup>(1)</sup>	Package Type	Package Drawing	Pins	Package Qty	Eco Plan <sup>(2)</sup>	Lead/Ball Finish	MSL Peak Temp <sup>(3)</sup>
LM4040C50QDBZT	ACTIVE	SOT-23	DBZ	3	250	Green (RoHS & no Sb/Br)	CU NIPDAU	Level-1-260C-UNLIM
LM4040C50QDBZTG4	ACTIVE	SOT-23	DBZ	3	250	Green (RoHS & no Sb/Br)	CU NIPDAU	Level-1-260C-UNLIM
LM4040C82IDBZR	ACTIVE	SOT-23	DBZ	3	3000	Green (RoHS & no Sb/Br)	CU NIPDAU	Level-1-260C-UNLIM
LM4040C82IDBZRG4	ACTIVE	SOT-23	DBZ	3	3000	Green (RoHS & no Sb/Br)	CU NIPDAU	Level-1-260C-UNLIM
LM4040C82IDBZT	ACTIVE	SOT-23	DBZ	3	250	Green (RoHS & no Sb/Br)	CU NIPDAU	Level-1-260C-UNLIM
LM4040C82IDBZTG4	ACTIVE	SOT-23	DBZ	3	250	Green (RoHS & no Sb/Br)	CU NIPDAU	Level-1-260C-UNLIM
LM4040C82IDCKR	ACTIVE	SC70	DCK	5	3000	Green (RoHS & no Sb/Br)	CU NIPDAU	Level-1-260C-UNLIM
LM4040C82IDCKRG4	ACTIVE	SC70	DCK	5	3000	Green (RoHS & no Sb/Br)	CU NIPDAU	Level-1-260C-UNLIM
LM4040C82ILP	ACTIVE	TO-92	LP	3	1000	Pb-Free (RoHS)	CU SN	N / A for Pkg Type
LM4040C82ILPR	ACTIVE	TO-92	LP	3	2000	Pb-Free (RoHS)	CU SN	N / A for Pkg Type
LM4040D20IDBZR	ACTIVE	SOT-23	DBZ	3	3000	Green (RoHS & no Sb/Br)	CU NIPDAU	Level-1-260C-UNLIM
LM4040D20IDBZRG4	ACTIVE	SOT-23	DBZ	3	3000	Green (RoHS & no Sb/Br)	CU NIPDAU	Level-1-260C-UNLIM
LM4040D20IDBZT	ACTIVE	SOT-23	DBZ	3	250	Green (RoHS & no Sb/Br)	CU NIPDAU	Level-1-260C-UNLIM
LM4040D20IDBZTG4	ACTIVE	SOT-23	DBZ	3	250	Green (RoHS & no Sb/Br)	CU NIPDAU	Level-1-260C-UNLIM
LM4040D20IDCKR	ACTIVE	SC70	DCK	5	3000	Green (RoHS & no Sb/Br)	CU NIPDAU	Level-1-260C-UNLIM
LM4040D20IDCKRE4	ACTIVE	SC70	DCK	5	3000	Green (RoHS & no Sb/Br)	CU NIPDAU	Level-1-260C-UNLIM
LM4040D20IDCKRG4	ACTIVE	SC70	DCK	5	3000	Green (RoHS & no Sb/Br)	CU NIPDAU	Level-1-260C-UNLIM
LM4040D20ILP	ACTIVE	TO-92	LP	3	1000	Pb-Free (RoHS)	CU SN	N / A for Pkg Type
LM4040D20ILPR	ACTIVE	TO-92	LP	3	2000	Pb-Free (RoHS)	CU SN	N / A for Pkg Type
LM4040D20QDBZR	ACTIVE	SOT-23	DBZ	3	3000	Green (RoHS & no Sb/Br)	CU NIPDAU	Level-1-260C-UNLIM
LM4040D20QDBZRG4	ACTIVE	SOT-23	DBZ	3	3000	Green (RoHS & no Sb/Br)	CU NIPDAU	Level-1-260C-UNLIM
LM4040D20QDBZT	ACTIVE	SOT-23	DBZ	3	250	Green (RoHS & no Sb/Br)	CU NIPDAU	Level-1-260C-UNLIM
LM4040D20QDBZTG4	ACTIVE	SOT-23	DBZ	3	250	Green (RoHS & no Sb/Br)	CU NIPDAU	Level-1-260C-UNLIM
LM4040D25IDBZR	ACTIVE	SOT-23	DBZ	3	3000	Green (RoHS & no Sb/Br)	CU NIPDAU	Level-1-260C-UNLIM
LM4040D25IDBZRG4	ACTIVE	SOT-23	DBZ	3	3000	Green (RoHS & no Sb/Br)	CU NIPDAU	Level-1-260C-UNLIM
LM4040D25IDBZT	ACTIVE	SOT-23	DBZ	3	250	Green (RoHS & no Sb/Br)	CU NIPDAU	Level-1-260C-UNLIM

Orderable Device	Status <sup>(1)</sup>	Package Type	Package Drawing	Pins	Package Qty	Eco Plan <sup>(2)</sup>	Lead/Ball Finish	MSL Peak Temp <sup>(3)</sup>
LM4040D25IDBZTG4	ACTIVE	SOT-23	DBZ	3	250	Green (RoHS & no Sb/Br)	CU NIPDAU	Level-1-260C-UNLIM
LM4040D25IDCKR	ACTIVE	SC70	DCK	5	3000	Green (RoHS & no Sb/Br)	CU NIPDAU	Level-1-260C-UNLIM
LM4040D25IDCKRE4	ACTIVE	SC70	DCK	5	3000	Green (RoHS & no Sb/Br)	CU NIPDAU	Level-1-260C-UNLIM
LM4040D25IDCKRG4	ACTIVE	SC70	DCK	5	3000	Green (RoHS & no Sb/Br)	CU NIPDAU	Level-1-260C-UNLIM
LM4040D25IDCKT	ACTIVE	SC70	DCK	5	250	Green (RoHS & no Sb/Br)	CU NIPDAU	Level-1-260C-UNLIM
LM4040D25IDCKTE4	ACTIVE	SC70	DCK	5	250	Green (RoHS & no Sb/Br)	CU NIPDAU	Level-1-260C-UNLIM
LM4040D25IDCKTG4	ACTIVE	SC70	DCK	5	250	Green (RoHS & no Sb/Br)	CU NIPDAU	Level-1-260C-UNLIM
LM4040D25ILP	ACTIVE	TO-92	LP	3	1000	Pb-Free (RoHS)	CU SN	N / A for Pkg Type
LM4040D25ILPR	ACTIVE	TO-92	LP	3	2000	Pb-Free (RoHS)	CU SN	N / A for Pkg Type
LM4040D25QDBZR	ACTIVE	SOT-23	DBZ	3	3000	Green (RoHS & no Sb/Br)	CU NIPDAU	Level-1-260C-UNLIM
LM4040D25QDBZRG4	ACTIVE	SOT-23	DBZ	3	3000	Green (RoHS & no Sb/Br)	CU NIPDAU	Level-1-260C-UNLIM
LM4040D25QDBZT	ACTIVE	SOT-23	DBZ	3	250	Green (RoHS & no Sb/Br)	CU NIPDAU	Level-1-260C-UNLIM
LM4040D25QDBZTG4	ACTIVE	SOT-23	DBZ	3	250	Green (RoHS & no Sb/Br)	CU NIPDAU	Level-1-260C-UNLIM
LM4040D30IDBZR	ACTIVE	SOT-23	DBZ	3	3000	Green (RoHS & no Sb/Br)	CU NIPDAU	Level-1-260C-UNLIM
LM4040D30IDBZRG4	ACTIVE	SOT-23	DBZ	3	3000	Green (RoHS & no Sb/Br)	CU NIPDAU	Level-1-260C-UNLIM
LM4040D30IDBZT	ACTIVE	SOT-23	DBZ	3	250	Green (RoHS & no Sb/Br)	CU NIPDAU	Level-1-260C-UNLIM
LM4040D30IDBZTG4	ACTIVE	SOT-23	DBZ	3	250	Green (RoHS & no Sb/Br)	CU NIPDAU	Level-1-260C-UNLIM
LM4040D30IDCKR	ACTIVE	SC70	DCK	5	3000	Green (RoHS & no Sb/Br)	CU NIPDAU	Level-1-260C-UNLIM
LM4040D30IDCKRE4	ACTIVE	SC70	DCK	5	3000	Green (RoHS & no Sb/Br)	CU NIPDAU	Level-1-260C-UNLIM
LM4040D30IDCKRG4	ACTIVE	SC70	DCK	5	3000	Green (RoHS & no Sb/Br)	CU NIPDAU	Level-1-260C-UNLIM
LM4040D30IDCKT	PREVIEW	SC70	DCK	5	250	TBD	Call TI	Call TI
LM4040D30ILP	ACTIVE	TO-92	LP	3	1000	Pb-Free (RoHS)	CU SN	N / A for Pkg Type
LM4040D30ILPM	PREVIEW	TO-92	LP	3	2000	TBD	Call TI	Call TI
LM4040D30ILPR	ACTIVE	TO-92	LP	3	2000	Pb-Free (RoHS)	CU SN	N / A for Pkg Type
LM4040D30QDBZR	ACTIVE	SOT-23	DBZ	3	3000	Green (RoHS & no Sb/Br)	CU NIPDAU	Level-1-260C-UNLIM
LM4040D30QDBZRG4	ACTIVE	SOT-23	DBZ	3	3000	Green (RoHS & no Sb/Br)	CU NIPDAU	Level-1-260C-UNLIM
LM4040D30QDBZT	ACTIVE	SOT-23	DBZ	3	250	Green (RoHS & no Sb/Br)	CU NIPDAU	Level-1-260C-UNLIM

Orderable Device	Status <sup>(1)</sup>	Package Type	Package Drawing	Pins	Package Qty	Eco Plan <sup>(2)</sup>	Lead/Ball Finish	MSL Peak Temp <sup>(3)</sup>
						no Sb/Br)		
LM4040D30QDBZTG4	ACTIVE	SOT-23	DBZ	3	250	Green (RoHS & no Sb/Br)	CU NIPDAU	Level-1-260C-UNLIM
LM4040D41IDBZR	ACTIVE	SOT-23	DBZ	3	3000	Green (RoHS & no Sb/Br)	CU NIPDAU	Level-1-260C-UNLIM
LM4040D41IDBZRG4	ACTIVE	SOT-23	DBZ	3	3000	Green (RoHS & no Sb/Br)	CU NIPDAU	Level-1-260C-UNLIM
LM4040D41IDBZT	ACTIVE	SOT-23	DBZ	3	250	Green (RoHS & no Sb/Br)	CU NIPDAU	Level-1-260C-UNLIM
LM4040D41IDBZTG4	ACTIVE	SOT-23	DBZ	3	250	Green (RoHS & no Sb/Br)	CU NIPDAU	Level-1-260C-UNLIM
LM4040D41IDCKR	ACTIVE	SC70	DCK	5	3000	Green (RoHS & no Sb/Br)	CU NIPDAU	Level-1-260C-UNLIM
LM4040D41IDCKRE4	ACTIVE	SC70	DCK	5	3000	Green (RoHS & no Sb/Br)	CU NIPDAU	Level-1-260C-UNLIM
LM4040D41IDCKRG4	ACTIVE	SC70	DCK	5	3000	Green (RoHS & no Sb/Br)	CU NIPDAU	Level-1-260C-UNLIM
LM4040D41ILP	ACTIVE	TO-92	LP	3	1000	Pb-Free (RoHS)	CU SN	N / A for Pkg Type
LM4040D41ILPR	ACTIVE	TO-92	LP	3	2000	Pb-Free (RoHS)	CU SN	N / A for Pkg Type
LM4040D50IDBZR	ACTIVE	SOT-23	DBZ	3	3000	Green (RoHS & no Sb/Br)	CU NIPDAU	Level-1-260C-UNLIM
LM4040D50IDBZRG4	ACTIVE	SOT-23	DBZ	3	3000	Green (RoHS & no Sb/Br)	CU NIPDAU	Level-1-260C-UNLIM
LM4040D50IDBZT	ACTIVE	SOT-23	DBZ	3	250	Green (RoHS & no Sb/Br)	CU NIPDAU	Level-1-260C-UNLIM
LM4040D50IDBZTG4	ACTIVE	SOT-23	DBZ	3	250	Green (RoHS & no Sb/Br)	CU NIPDAU	Level-1-260C-UNLIM
LM4040D50IDCKR	ACTIVE	SC70	DCK	5	3000	Green (RoHS & no Sb/Br)	CU NIPDAU	Level-1-260C-UNLIM
LM4040D50IDCKRE4	ACTIVE	SC70	DCK	5	3000	Green (RoHS & no Sb/Br)	CU NIPDAU	Level-1-260C-UNLIM
LM4040D50IDCKRG4	ACTIVE	SC70	DCK	5	3000	Green (RoHS & no Sb/Br)	CU NIPDAU	Level-1-260C-UNLIM
LM4040D50ILP	ACTIVE	TO-92	LP	3	1000	Pb-Free (RoHS)	CU SN	N / A for Pkg Type
LM4040D50ILPR	ACTIVE	TO-92	LP	3	2000	Pb-Free (RoHS)	CU SN	N / A for Pkg Type
LM4040D50QDBZR	ACTIVE	SOT-23	DBZ	3	3000	Green (RoHS & no Sb/Br)	CU NIPDAU	Level-1-260C-UNLIM
LM4040D50QDBZRG4	ACTIVE	SOT-23	DBZ	3	3000	Green (RoHS & no Sb/Br)	CU NIPDAU	Level-1-260C-UNLIM
LM4040D50QDBZT	ACTIVE	SOT-23	DBZ	3	250	Green (RoHS & no Sb/Br)	CU NIPDAU	Level-1-260C-UNLIM
LM4040D50QDBZTG4	ACTIVE	SOT-23	DBZ	3	250	Green (RoHS & no Sb/Br)	CU NIPDAU	Level-1-260C-UNLIM
LM4040D82IDBZR	ACTIVE	SOT-23	DBZ	3	3000	Green (RoHS & no Sb/Br)	CU NIPDAU	Level-1-260C-UNLIM
LM4040D82IDBZRG4	ACTIVE	SOT-23	DBZ	3	3000	Green (RoHS & no Sb/Br)	CU NIPDAU	Level-1-260C-UNLIM

Orderable Device	Status <sup>(1)</sup>	Package Type	Package Drawing	Pins	Package Qty	Eco Plan <sup>(2)</sup>	Lead/Ball Finish	MSL Peak Temp <sup>(3)</sup>
LM4040D82IDBZT	ACTIVE	SOT-23	DBZ	3	250	Green (RoHS & no Sb/Br)	CU NIPDAU	Level-1-260C-UNLIM
LM4040D82IDBZTG4	ACTIVE	SOT-23	DBZ	3	250	Green (RoHS & no Sb/Br)	CU NIPDAU	Level-1-260C-UNLIM
LM4040D82IDCKR	ACTIVE	SC70	DCK	5	3000	Green (RoHS & no Sb/Br)	CU NIPDAU	Level-1-260C-UNLIM
LM4040D82IDCKRG4	ACTIVE	SC70	DCK	5	3000	Green (RoHS & no Sb/Br)	CU NIPDAU	Level-1-260C-UNLIM
LM4040D82ILP	ACTIVE	TO-92	LP	3	1000	Pb-Free (RoHS)	CU SN	N / A for Pkg Type
LM4040D82ILPR	ACTIVE	TO-92	LP	3	2000	Pb-Free (RoHS)	CU SN	N / A for Pkg Type

<sup>(1)</sup> The marketing status values are defined as follows:

**ACTIVE:** Product device recommended for new designs.

**LIFEBUY:** TI has announced that the device will be discontinued, and a lifetime-buy period is in effect.

**NRND:** Not recommended for new designs. Device is in production to support existing customers, but TI does not recommend using this part in a new design.

**PREVIEW:** Device has been announced but is not in production. Samples may or may not be available.

**OBSOLETE:** TI has discontinued the production of the device.

<sup>(2)</sup> Eco Plan - The planned eco-friendly classification: Pb-Free (RoHS), Pb-Free (RoHS Exempt), or Green (RoHS & no Sb/Br) - please check <http://www.ti.com/productcontent> for the latest availability information and additional product content details.

**TBD:** The Pb-Free/Green conversion plan has not been defined.

**Pb-Free (RoHS):** TI's terms "Lead-Free" or "Pb-Free" mean semiconductor products that are compatible with the current RoHS requirements for all 6 substances, including the requirement that lead not exceed 0.1% by weight in homogeneous materials. Where designed to be soldered at high temperatures, TI Pb-Free products are suitable for use in specified lead-free processes.

**Pb-Free (RoHS Exempt):** This component has a RoHS exemption for either 1) lead-based flip-chip solder bumps used between the die and package, or 2) lead-based die adhesive used between the die and leadframe. The component is otherwise considered Pb-Free (RoHS compatible) as defined above.

**Green (RoHS & no Sb/Br):** TI defines "Green" to mean Pb-Free (RoHS compatible), and free of Bromine (Br) and Antimony (Sb) based flame retardants (Br or Sb do not exceed 0.1% by weight in homogeneous material)

<sup>(3)</sup> MSL, Peak Temp. -- The Moisture Sensitivity Level rating according to the JEDEC industry standard classifications, and peak solder temperature.

**Important Information and Disclaimer:** The information provided on this page represents TI's knowledge and belief as of the date that it is provided. TI bases its knowledge and belief on information provided by third parties, and makes no representation or warranty as to the accuracy of such information. Efforts are underway to better integrate information from third parties. TI has taken and continues to take reasonable steps to provide representative and accurate information but may not have conducted destructive testing or chemical analysis on incoming materials and chemicals. TI and TI suppliers consider certain information to be proprietary, and thus CAS numbers and other limited information may not be available for release.

In no event shall TI's liability arising out of such information exceed the total purchase price of the TI part(s) at issue in this document sold by TI to Customer on an annual basis.

**TAPE AND REEL BOX INFORMATION**

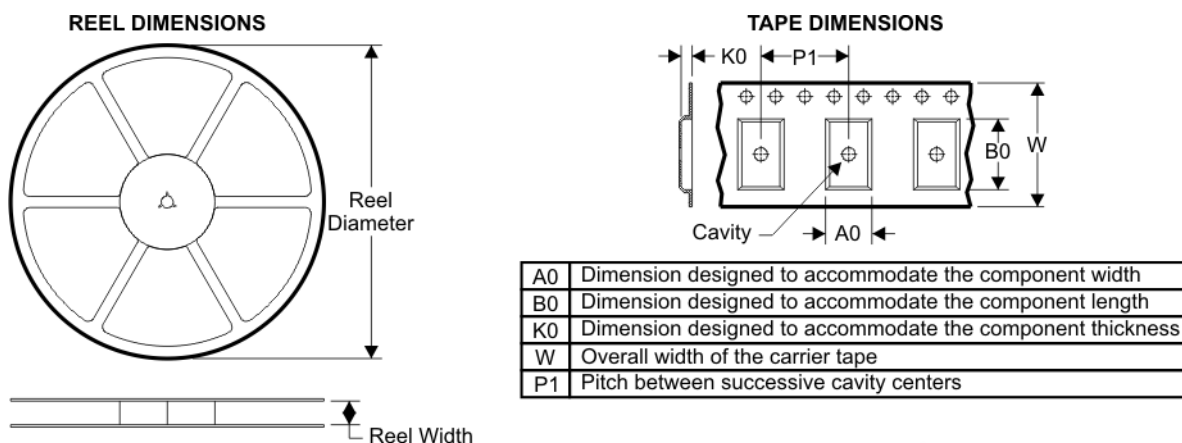

**QUADRANT ASSIGNMENTS FOR PIN 1 ORIENTATION IN TAPE**

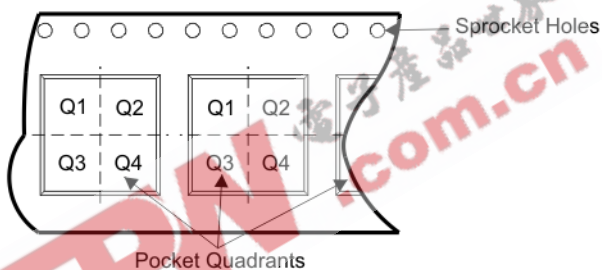

Device	Package	Pins	Site	Reel Diameter (mm)	Reel Width (mm)	A0 (mm)	B0 (mm)	K0 (mm)	P1 (mm)	W (mm)	Pin1 Quadrant
LM4040A10IDBZR	DBZ	3	SITE 48	179	8	3.15	2.95	1.22	4	8	Q3
LM4040A10IDBZT	DBZ	3	SITE 48	179	8	3.15	2.95	1.22	4	8	Q3
LM4040A10IDCKR	DCK	5	SITE 48	179	8	2.2	2.5	1.2	4	8	Q3
LM4040A20IDBZR	DBZ	3	SITE 48	179	8	3.15	2.95	1.22	4	8	Q3
LM4040A20IDBZT	DBZ	3	SITE 48	179	8	3.15	2.95	1.22	4	8	Q3
LM4040A20IDCKR	DCK	5	SITE 48	179	8	2.2	2.5	1.2	4	8	Q3
LM4040A25IDBZR	DBZ	3	SITE 48	179	8	3.15	2.95	1.22	4	8	Q3
LM4040A25IDBZT	DBZ	3	SITE 48	179	8	3.15	2.95	1.22	4	8	Q3
LM4040A25IDCKR	DCK	5	SITE 48	179	8	2.2	2.5	1.2	4	8	Q3
LM4040A30IDBZR	DBZ	3	SITE 48	179	8	3.15	2.95	1.22	4	8	Q3
LM4040A30IDBZT	DBZ	3	SITE 48	179	8	3.15	2.95	1.22	4	8	Q3
LM4040A30IDCKR	DCK	5	SITE 48	179	8	2.2	2.5	1.2	4	8	Q3
LM4040A41IDBZR	DBZ	3	SITE 48	179	8	3.15	2.95	1.22	4	8	Q3
LM4040A41IDBZT	DBZ	3	SITE 48	179	8	3.15	2.95	1.22	4	8	Q3
LM4040A41IDCKR	DCK	5	SITE 48	179	8	2.2	2.5	1.2	4	8	Q3
LM4040A50IDBZR	DBZ	3	SITE 48	179	8	3.15	2.95	1.22	4	8	Q3
LM4040A50IDBZT	DBZ	3	SITE 48	179	8	3.15	2.95	1.22	4	8	Q3
LM4040A50IDCKR	DCK	5	SITE 48	179	8	2.2	2.5	1.2	4	8	Q3
LM4040A82IDBZR	DBZ	3	SITE 48	179	8	3.15	2.95	1.22	4	8	Q3



Device	Package	Pins	Site	Reel Diameter (mm)	Reel Width (mm)	A0 (mm)	B0 (mm)	K0 (mm)	P1 (mm)	W (mm)	Pin1 Quadrant
LM4040A82IDBZT	DBZ	3	SITE 48	179	8	3.15	2.95	1.22	4	8	Q3
LM4040A82IDCKR	DCK	5	SITE 48	179	8	2.2	2.5	1.2	4	8	Q3
LM4040B10IDBZR	DBZ	3	SITE 48	179	8	3.15	2.95	1.22	4	8	Q3
LM4040B10IDBZT	DBZ	3	SITE 48	179	8	3.15	2.95	1.22	4	8	Q3
LM4040B10IDCKR	DCK	5	SITE 48	179	8	2.2	2.5	1.2	4	8	Q3
LM4040B20IDBZR	DBZ	3	SITE 48	179	8	3.15	2.95	1.22	4	8	Q3
LM4040B20IDBZT	DBZ	3	SITE 48	179	8	3.15	2.95	1.22	4	8	Q3
LM4040B20IDCKR	DCK	5	SITE 48	179	8	2.2	2.5	1.2	4	8	Q3
LM4040B25IDBZR	DBZ	3	SITE 48	179	8	3.15	2.95	1.22	4	8	Q3
LM4040B25IDBZT	DBZ	3	SITE 48	179	8	3.15	2.95	1.22	4	8	Q3
LM4040B25IDCKR	DCK	5	SITE 48	179	8	2.2	2.5	1.2	4	8	Q3
LM4040B30IDBZR	DBZ	3	SITE 48	179	8	3.15	2.95	1.22	4	8	Q3
LM4040B30IDBZT	DBZ	3	SITE 48	179	8	3.15	2.95	1.22	4	8	Q3
LM4040B30IDCKR	DCK	5	SITE 48	179	8	2.2	2.5	1.2	4	8	Q3
LM4040B41IDBZR	DBZ	3	SITE 48	179	8	3.15	2.95	1.22	4	8	Q3
LM4040B41IDBZT	DBZ	3	SITE 48	179	8	3.15	2.95	1.22	4	8	Q3
LM4040B41IDCKR	DCK	5	SITE 48	179	8	2.2	2.5	1.2	4	8	Q3
LM4040B50IDBZR	DBZ	3	SITE 48	179	8	3.15	2.95	1.22	4	8	Q3
LM4040B50IDBZT	DBZ	3	SITE 48	179	8	3.15	2.95	1.22	4	8	Q3
LM4040B50IDCKR	DCK	5	SITE 48	179	8	2.2	2.5	1.2	4	8	Q3
LM4040B82IDBZR	DBZ	3	SITE 48	179	8	3.15	2.95	1.22	4	8	Q3
LM4040B82IDBZT	DBZ	3	SITE 48	179	8	3.15	2.95	1.22	4	8	Q3
LM4040B82IDCKR	DCK	5	SITE 48	179	8	2.2	2.5	1.2	4	8	Q3
LM4040C10IDBZR	DBZ	3	SITE 48	179	8	3.15	2.95	1.22	4	8	Q3
LM4040C10IDBZT	DBZ	3	SITE 48	179	8	3.15	2.95	1.22	4	8	Q3
LM4040C10IDCKR	DCK	5	SITE 48	179	8	2.2	2.5	1.2	4	8	Q3
LM4040C20IDBZR	DBZ	3	SITE 48	179	8	3.15	2.95	1.22	4	8	Q3
LM4040C20IDBZT	DBZ	3	SITE 48	179	8	3.15	2.95	1.22	4	8	Q3
LM4040C20IDCKR	DCK	5	SITE 48	179	8	2.2	2.5	1.2	4	8	Q3
LM4040C20QDBZR	DBZ	3	SITE 48	179	8	3.15	2.95	1.22	4	8	Q3
LM4040C20QDBZT	DBZ	3	SITE 48	179	8	3.15	2.95	1.22	4	8	Q3
LM4040C25IDBZR	DBZ	3	SITE 48	179	8	3.15	2.95	1.22	4	8	Q3
LM4040C25IDBZT	DBZ	3	SITE 48	179	8	3.15	2.95	1.22	4	8	Q3
LM4040C25IDCKR	DCK	5	SITE 48	179	8	2.2	2.5	1.2	4	8	Q3
LM4040C25IDCKT	DCK	5	SITE 48	179	8	2.2	2.5	1.2	4	8	Q3
LM4040C25QDBZR	DBZ	3	SITE 48	179	8	3.15	2.95	1.22	4	8	Q3
LM4040C25QDBZT	DBZ	3	SITE 48	179	8	3.15	2.95	1.22	4	8	Q3
LM4040C30IDBZR	DBZ	3	SITE 48	179	8	3.15	2.95	1.22	4	8	Q3
LM4040C30IDBZT	DBZ	3	SITE 48	179	8	3.15	2.95	1.22	4	8	Q3
LM4040C30IDCKR	DCK	5	SITE 48	179	8	2.2	2.5	1.2	4	8	Q3
LM4040C30QDBZR	DBZ	3	SITE 48	179	8	3.15	2.95	1.22	4	8	Q3
LM4040C30QDBZT	DBZ	3	SITE 48	179	8	3.15	2.95	1.22	4	8	Q3
LM4040C41IDBZR	DBZ	3	SITE 48	179	8	3.15	2.95	1.22	4	8	Q3

Device	Package	Pins	Site	Reel Diameter (mm)	Reel Width (mm)	A0 (mm)	B0 (mm)	K0 (mm)	P1 (mm)	W (mm)	Pin1 Quadrant
LM4040C41IDBZT	DBZ	3	SITE 48	179	8	3.15	2.95	1.22	4	8	Q3
LM4040C41IDCKR	DCK	5	SITE 48	179	8	2.2	2.5	1.2	4	8	Q3
LM4040C50IDBZR	DBZ	3	SITE 48	179	8	3.15	2.95	1.22	4	8	Q3
LM4040C50IDBZT	DBZ	3	SITE 48	179	8	3.15	2.95	1.22	4	8	Q3
LM4040C50IDCKR	DCK	5	SITE 48	179	8	2.2	2.5	1.2	4	8	Q3
LM4040C50QDBZR	DBZ	3	SITE 48	179	8	3.15	2.95	1.22	4	8	Q3
LM4040C50QDBZT	DBZ	3	SITE 48	179	8	3.15	2.95	1.22	4	8	Q3
LM4040C82IDBZR	DBZ	3	SITE 48	179	8	3.15	2.95	1.22	4	8	Q3
LM4040C82IDBZT	DBZ	3	SITE 48	179	8	3.15	2.95	1.22	4	8	Q3
LM4040C82IDCKR	DCK	5	SITE 48	179	8	2.2	2.5	1.2	4	8	Q3
LM4040D20IDBZR	DBZ	3	SITE 48	179	8	3.15	2.95	1.22	4	8	Q3
LM4040D20IDBZT	DBZ	3	SITE 48	179	8	3.15	2.95	1.22	4	8	Q3
LM4040D20IDCKR	DCK	5	SITE 48	179	8	2.2	2.5	1.2	4	8	Q3
LM4040D20QDBZR	DBZ	3	SITE 48	179	8	3.15	2.95	1.22	4	8	Q3
LM4040D20QDBZT	DBZ	3	SITE 48	179	8	3.15	2.95	1.22	4	8	Q3
LM4040D25IDBZR	DBZ	3	SITE 48	179	8	3.15	2.95	1.22	4	8	Q3
LM4040D25IDBZT	DBZ	3	SITE 48	179	8	3.15	2.95	1.22	4	8	Q3
LM4040D25IDCKR	DCK	5	SITE 48	179	8	2.2	2.5	1.2	4	8	Q3
LM4040D25IDCKT	DCK	5	SITE 48	179	8	2.2	2.5	1.2	4	8	Q3
LM4040D25QDBZR	DBZ	3	SITE 48	179	8	3.15	2.95	1.22	4	8	Q3
LM4040D25QDBZT	DBZ	3	SITE 48	179	8	3.15	2.95	1.22	4	8	Q3
LM4040D30IDBZR	DBZ	3	SITE 48	179	8	3.15	2.95	1.22	4	8	Q3
LM4040D30IDBZT	DBZ	3	SITE 48	179	8	3.15	2.95	1.22	4	8	Q3
LM4040D30IDCKR	DCK	5	SITE 48	179	8	2.2	2.5	1.2	4	8	Q3
LM4040D30QDBZR	DBZ	3	SITE 48	179	8	3.15	2.95	1.22	4	8	Q3
LM4040D30QDBZT	DBZ	3	SITE 48	179	8	3.15	2.95	1.22	4	8	Q3
LM4040D41IDBZR	DBZ	3	SITE 48	179	8	3.15	2.95	1.22	4	8	Q3
LM4040D41IDBZT	DBZ	3	SITE 48	179	8	3.15	2.95	1.22	4	8	Q3
LM4040D41IDCKR	DCK	5	SITE 48	179	8	2.2	2.5	1.2	4	8	Q3
LM4040D50IDBZR	DBZ	3	SITE 48	179	8	3.15	2.95	1.22	4	8	Q3
LM4040D50IDBZT	DBZ	3	SITE 48	179	8	3.15	2.95	1.22	4	8	Q3
LM4040D50IDCKR	DCK	5	SITE 48	179	8	2.2	2.5	1.2	4	8	Q3
LM4040D50QDBZR	DBZ	3	SITE 48	179	8	3.15	2.95	1.22	4	8	Q3
LM4040D50QDBZT	DBZ	3	SITE 48	179	8	3.15	2.95	1.22	4	8	Q3
LM4040D82IDBZR	DBZ	3	SITE 48	179	8	3.15	2.95	1.22	4	8	Q3
LM4040D82IDBZT	DBZ	3	SITE 48	179	8	3.15	2.95	1.22	4	8	Q3
LM4040D82IDCKR	DCK	5	SITE 48	179	8	2.2	2.5	1.2	4	8	Q3

**TAPE AND REEL BOX DIMENSIONS**

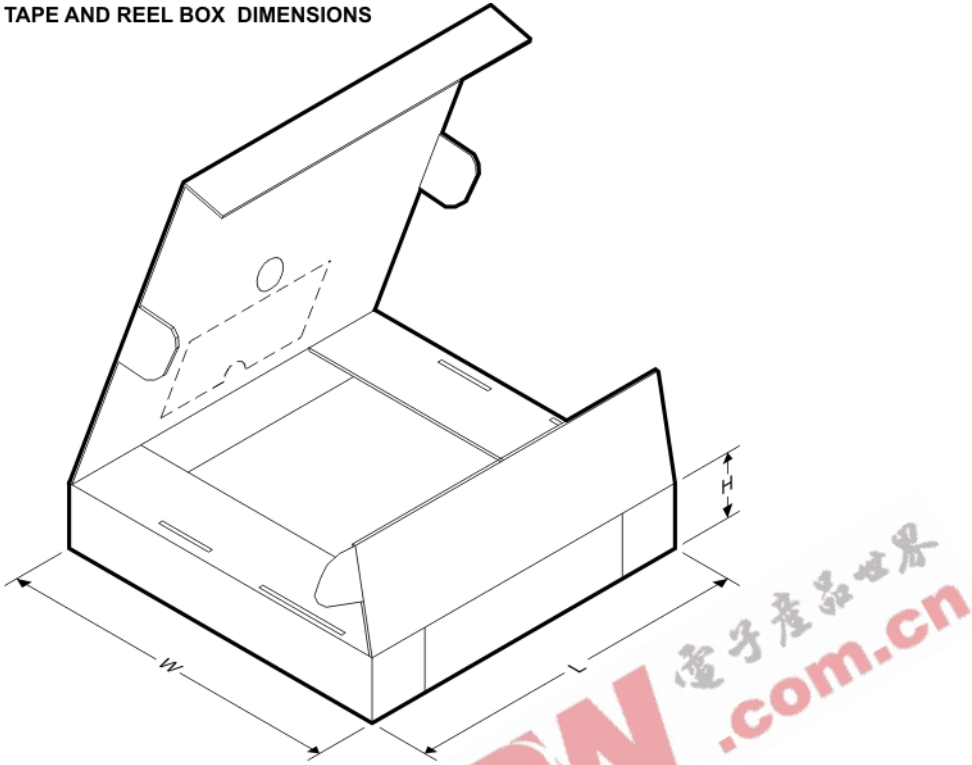

Device	Package	Pins	Site	Length (mm)	Width (mm)	Height (mm)
LM4040A10IDBZR	DBZ	3	SITE 48	220.0	205.0	50.0
LM4040A10IDBZT	DBZ	3	SITE 48	220.0	205.0	50.0
LM4040A10IDCKR	DCK	5	SITE 48	220.0	205.0	50.0
LM4040A20IDBZR	DBZ	3	SITE 48	220.0	205.0	50.0
LM4040A20IDBZT	DBZ	3	SITE 48	220.0	205.0	50.0
LM4040A20IDCKR	DCK	5	SITE 48	220.0	205.0	50.0
LM4040A25IDBZR	DBZ	3	SITE 48	220.0	205.0	50.0
LM4040A25IDBZT	DBZ	3	SITE 48	220.0	205.0	50.0
LM4040A25IDCKR	DCK	5	SITE 48	220.0	205.0	50.0
LM4040A30IDBZR	DBZ	3	SITE 48	220.0	205.0	50.0
LM4040A30IDBZT	DBZ	3	SITE 48	220.0	205.0	50.0
LM4040A30IDCKR	DCK	5	SITE 48	220.0	205.0	50.0
LM4040A41IDBZR	DBZ	3	SITE 48	220.0	205.0	50.0
LM4040A41IDBZT	DBZ	3	SITE 48	220.0	205.0	50.0
LM4040A41IDCKR	DCK	5	SITE 48	220.0	205.0	50.0
LM4040A50IDBZR	DBZ	3	SITE 48	220.0	205.0	50.0
LM4040A50IDBZT	DBZ	3	SITE 48	220.0	205.0	50.0
LM4040A50IDCKR	DCK	5	SITE 48	220.0	205.0	50.0
LM4040A82IDBZR	DBZ	3	SITE 48	220.0	205.0	50.0
LM4040A82IDBZT	DBZ	3	SITE 48	220.0	205.0	50.0
LM4040A82IDCKR	DCK	5	SITE 48	220.0	205.0	50.0

Device	Package	Pins	Site	Length (mm)	Width (mm)	Height (mm)
LM4040B10IDBZR	DBZ	3	SITE 48	220.0	205.0	50.0
LM4040B10IDBZT	DBZ	3	SITE 48	220.0	205.0	50.0
LM4040B10IDCKR	DCK	5	SITE 48	220.0	205.0	50.0
LM4040B20IDBZR	DBZ	3	SITE 48	220.0	205.0	50.0
LM4040B20IDBZT	DBZ	3	SITE 48	220.0	205.0	50.0
LM4040B20IDCKR	DCK	5	SITE 48	220.0	205.0	50.0
LM4040B25IDBZR	DBZ	3	SITE 48	220.0	205.0	50.0
LM4040B25IDBZT	DBZ	3	SITE 48	220.0	205.0	50.0
LM4040B25IDCKR	DCK	5	SITE 48	220.0	205.0	50.0
LM4040B30IDBZR	DBZ	3	SITE 48	220.0	205.0	50.0
LM4040B30IDBZT	DBZ	3	SITE 48	220.0	205.0	50.0
LM4040B30IDCKR	DCK	5	SITE 48	220.0	205.0	50.0
LM4040B41IDBZR	DBZ	3	SITE 48	220.0	205.0	50.0
LM4040B41IDBZT	DBZ	3	SITE 48	220.0	205.0	50.0
LM4040B41IDCKR	DCK	5	SITE 48	220.0	205.0	50.0
LM4040B50IDBZR	DBZ	3	SITE 48	220.0	205.0	50.0
LM4040B50IDBZT	DBZ	3	SITE 48	220.0	205.0	50.0
LM4040B50IDCKR	DCK	5	SITE 48	220.0	205.0	50.0
LM4040B82IDBZR	DBZ	3	SITE 48	220.0	205.0	50.0
LM4040B82IDBZT	DBZ	3	SITE 48	220.0	205.0	50.0
LM4040B82IDCKR	DCK	5	SITE 48	220.0	205.0	50.0
LM4040C10IDBZR	DBZ	3	SITE 48	220.0	205.0	50.0
LM4040C10IDBZT	DBZ	3	SITE 48	220.0	205.0	50.0
LM4040C10IDCKR	DCK	5	SITE 48	220.0	205.0	50.0
LM4040C20IDBZR	DBZ	3	SITE 48	220.0	205.0	50.0
LM4040C20IDBZT	DBZ	3	SITE 48	220.0	205.0	50.0
LM4040C20IDCKR	DCK	5	SITE 48	220.0	205.0	50.0
LM4040C20QDBZR	DBZ	3	SITE 48	220.0	205.0	50.0
LM4040C20QDBZT	DBZ	3	SITE 48	220.0	205.0	50.0
LM4040C25IDBZR	DBZ	3	SITE 48	220.0	205.0	50.0
LM4040C25IDBZT	DBZ	3	SITE 48	220.0	205.0	50.0
LM4040C25IDCKR	DCK	5	SITE 48	220.0	205.0	50.0
LM4040C25IDCKT	DCK	5	SITE 48	220.0	205.0	50.0
LM4040C25QDBZR	DBZ	3	SITE 48	220.0	205.0	50.0
LM4040C25QDBZT	DBZ	3	SITE 48	220.0	205.0	50.0
LM4040C30IDBZR	DBZ	3	SITE 48	220.0	205.0	50.0
LM4040C30IDBZT	DBZ	3	SITE 48	220.0	205.0	50.0
LM4040C30IDCKR	DCK	5	SITE 48	220.0	205.0	50.0
LM4040C30QDBZR	DBZ	3	SITE 48	220.0	205.0	50.0
LM4040C30QDBZT	DBZ	3	SITE 48	220.0	205.0	50.0
LM4040C41IDBZR	DBZ	3	SITE 48	220.0	205.0	50.0
LM4040C41IDBZT	DBZ	3	SITE 48	220.0	205.0	50.0
LM4040C41IDCKR	DCK	5	SITE 48	220.0	205.0	50.0
LM4040C50IDBZR	DBZ	3	SITE 48	220.0	205.0	50.0

Device	Package	Pins	Site	Length (mm)	Width (mm)	Height (mm)
LM4040C50IDBZT	DBZ	3	SITE 48	220.0	205.0	50.0
LM4040C50IDCKR	DCK	5	SITE 48	220.0	205.0	50.0
LM4040C50QDBZR	DBZ	3	SITE 48	220.0	205.0	50.0
LM4040C50QDBZT	DBZ	3	SITE 48	220.0	205.0	50.0
LM4040C82IDBZR	DBZ	3	SITE 48	220.0	205.0	50.0
LM4040C82IDBZT	DBZ	3	SITE 48	220.0	205.0	50.0
LM4040C82IDCKR	DCK	5	SITE 48	220.0	205.0	50.0
LM4040D20IDBZR	DBZ	3	SITE 48	220.0	205.0	50.0
LM4040D20IDBZT	DBZ	3	SITE 48	220.0	205.0	50.0
LM4040D20IDCKR	DCK	5	SITE 48	220.0	205.0	50.0
LM4040D20QDBZR	DBZ	3	SITE 48	220.0	205.0	50.0
LM4040D20QDBZT	DBZ	3	SITE 48	220.0	205.0	50.0
LM4040D25IDBZR	DBZ	3	SITE 48	220.0	205.0	50.0
LM4040D25IDBZT	DBZ	3	SITE 48	220.0	205.0	50.0
LM4040D25IDCKR	DCK	5	SITE 48	220.0	205.0	50.0
LM4040D25IDCKT	DCK	5	SITE 48	220.0	205.0	50.0
LM4040D25QDBZR	DBZ	3	SITE 48	220.0	205.0	50.0
LM4040D25QDBZT	DBZ	3	SITE 48	220.0	205.0	50.0
LM4040D30IDBZR	DBZ	3	SITE 48	220.0	205.0	50.0
LM4040D30IDBZT	DBZ	3	SITE 48	220.0	205.0	50.0
LM4040D30IDCKR	DCK	5	SITE 48	220.0	205.0	50.0
LM4040D30QDBZR	DBZ	3	SITE 48	220.0	205.0	50.0
LM4040D30QDBZT	DBZ	3	SITE 48	220.0	205.0	50.0
LM4040D41IDBZR	DBZ	3	SITE 48	220.0	205.0	50.0
LM4040D41IDBZT	DBZ	3	SITE 48	220.0	205.0	50.0
LM4040D41IDCKR	DCK	5	SITE 48	220.0	205.0	50.0
LM4040D50IDBZR	DBZ	3	SITE 48	220.0	205.0	50.0
LM4040D50IDBZT	DBZ	3	SITE 48	220.0	205.0	50.0
LM4040D50IDCKR	DCK	5	SITE 48	220.0	205.0	50.0
LM4040D50QDBZR	DBZ	3	SITE 48	220.0	205.0	50.0
LM4040D50QDBZT	DBZ	3	SITE 48	220.0	205.0	50.0
LM4040D82IDBZR	DBZ	3	SITE 48	220.0	205.0	50.0
LM4040D82IDBZT	DBZ	3	SITE 48	220.0	205.0	50.0
LM4040D82IDCKR	DCK	5	SITE 48	220.0	205.0	50.0

MECHANICAL DATA

DCK (R-PDSO-G5)

PLASTIC SMALL-OUTLINE PACKAGE

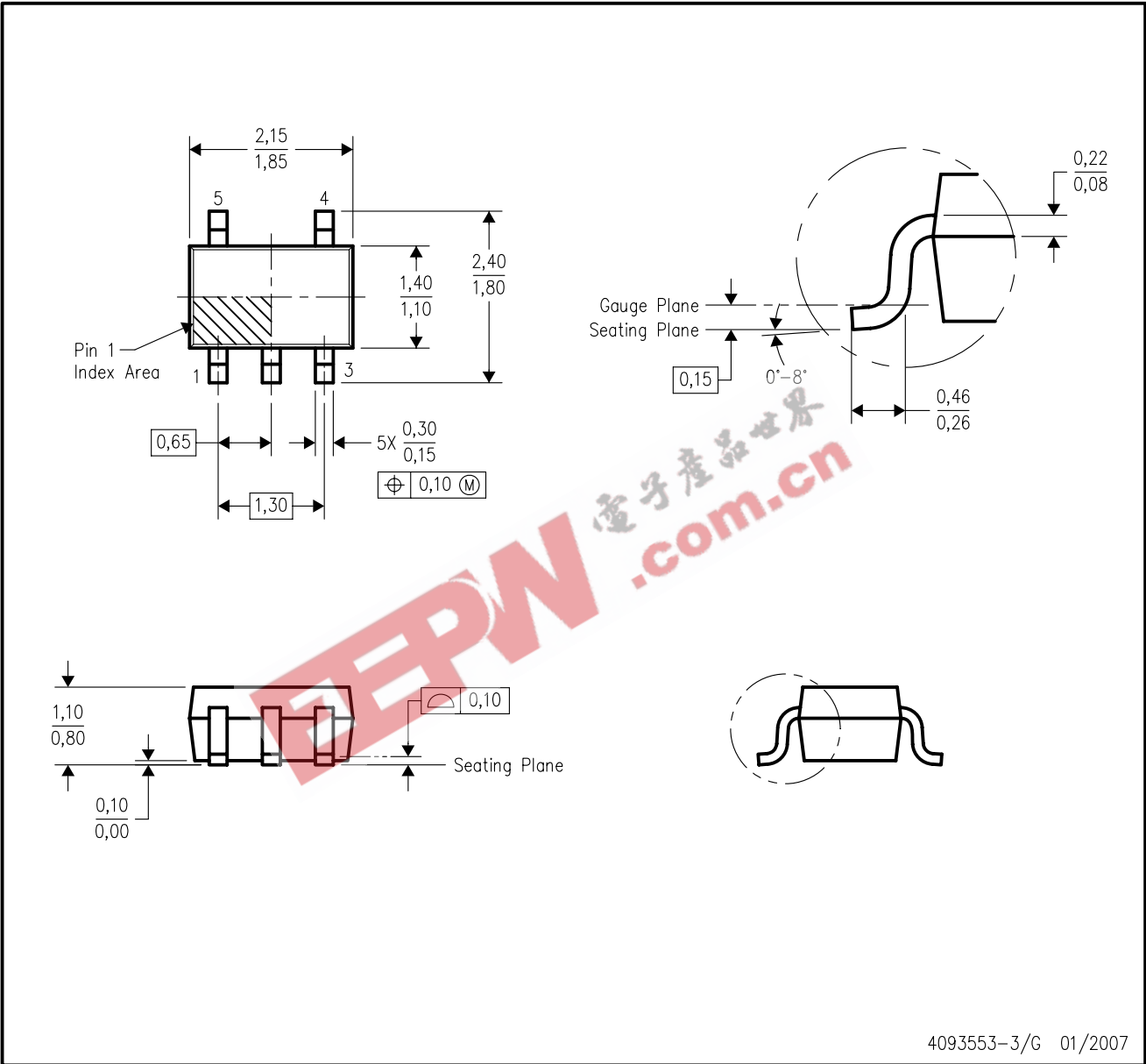

4093553-3/G 01/2007

- NOTES:
- A. All linear dimensions are in millimeters.
  - B. This drawing is subject to change without notice.
  - C. Body dimensions do not include mold flash or protrusion. Mold flash and protrusion shall not exceed 0.15 per side.
  - D. Falls within JEDEC MO-203 variation AA.

DBZ (R-PDSO-G3)

PLASTIC SMALL-OUTLINE

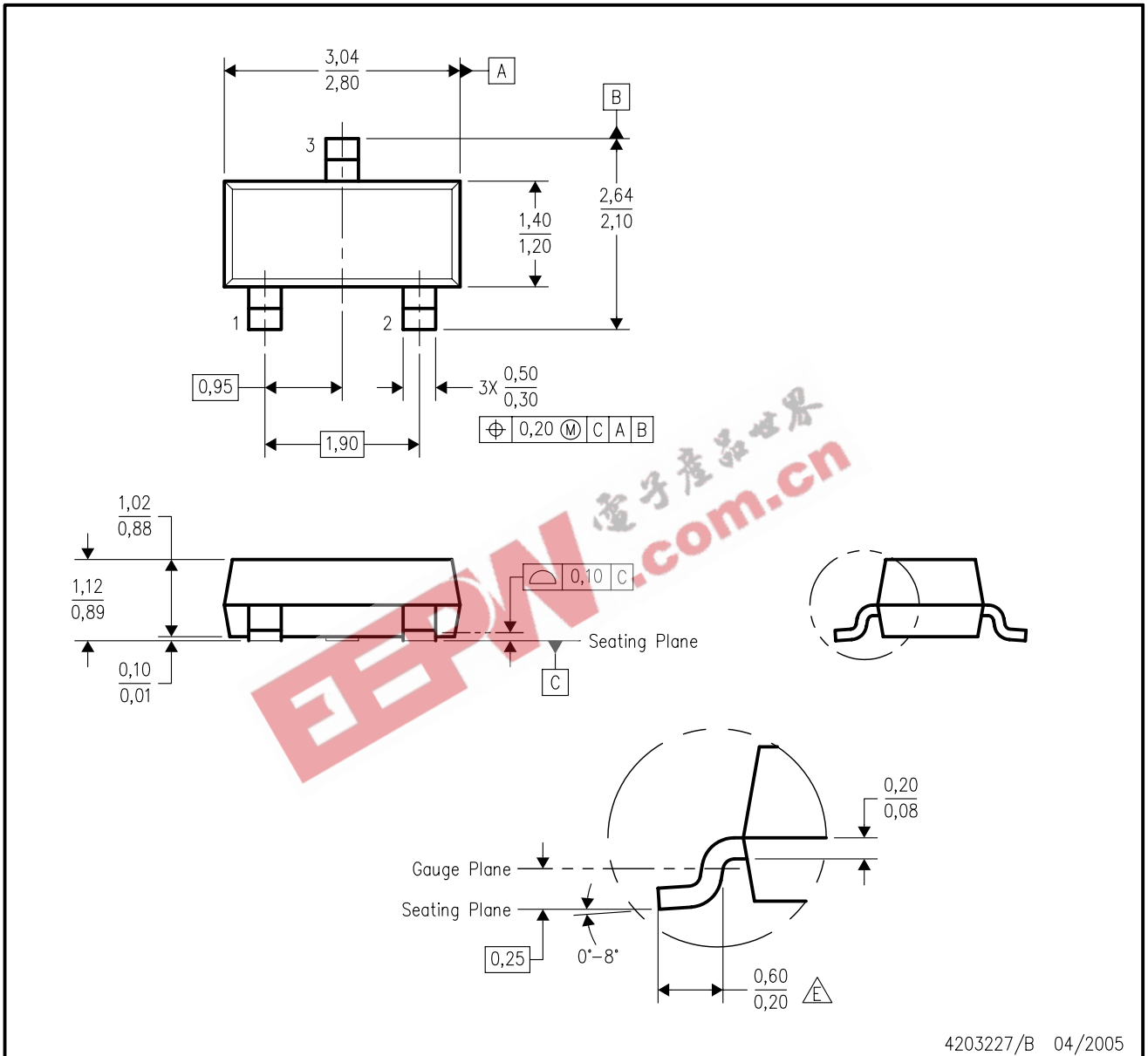

- NOTES:
- A. All linear dimensions are in millimeters. Dimensioning and tolerancing per ASME Y14.5M-1994.
  - B. This drawing is subject to change without notice.
  - C. Lead dimensions are inclusive of plating.
  - D. Body dimensions are exclusive of mold flash and protrusion. Mold flash and protrusion not to exceed 0.25 per side.
  - $\triangle E$  Falls within JEDEC TO-236 variation AB, except minimum foot length.

# MECHANICAL DATA



MSOT002A – OCTOBER 1994 – REVISED NOVEMBER 2001

## LP (O-PBCY-W3)

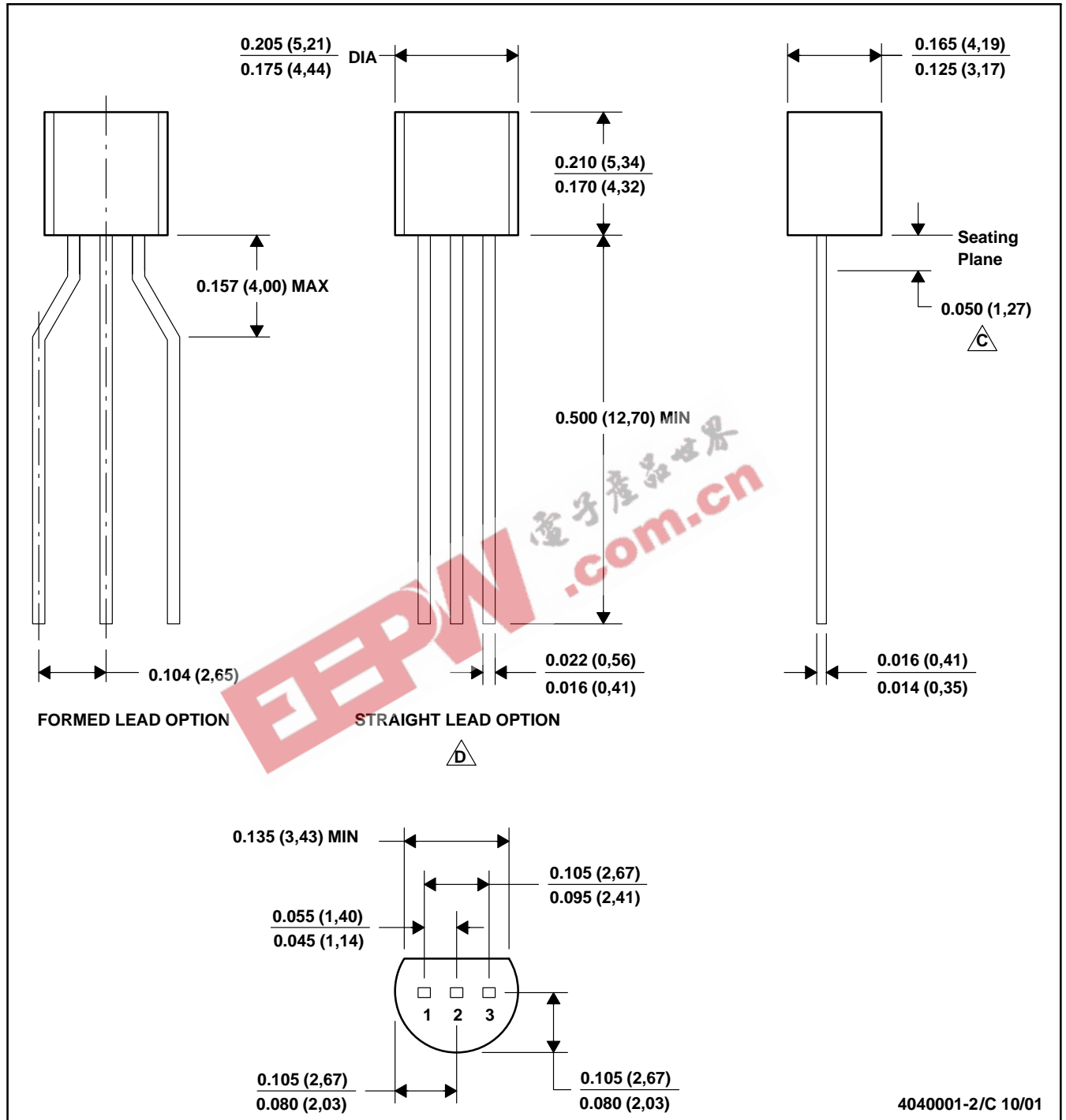
## PLASTIC CYLINDRICAL PACKAGE



4040001-2/C 10/01

- NOTES:
- A. All linear dimensions are in inches (millimeters).
  - B. This drawing is subject to change without notice.
  -  Lead dimensions are not controlled within this area
  -  Falls within JEDEC TO-226 Variation AA (TO-226 replaces TO-92)
  - E. Shipping Method:
    - Straight lead option available in bulk pack only.
    - Formed lead option available in tape & reel or ammo pack.



# MECHANICAL DATA

MSOT002A – OCTOBER 1994 – REVISED NOVEMBER 2001

LP (O-PBCY-W3)

PLASTIC CYLINDRICAL PACKAGE

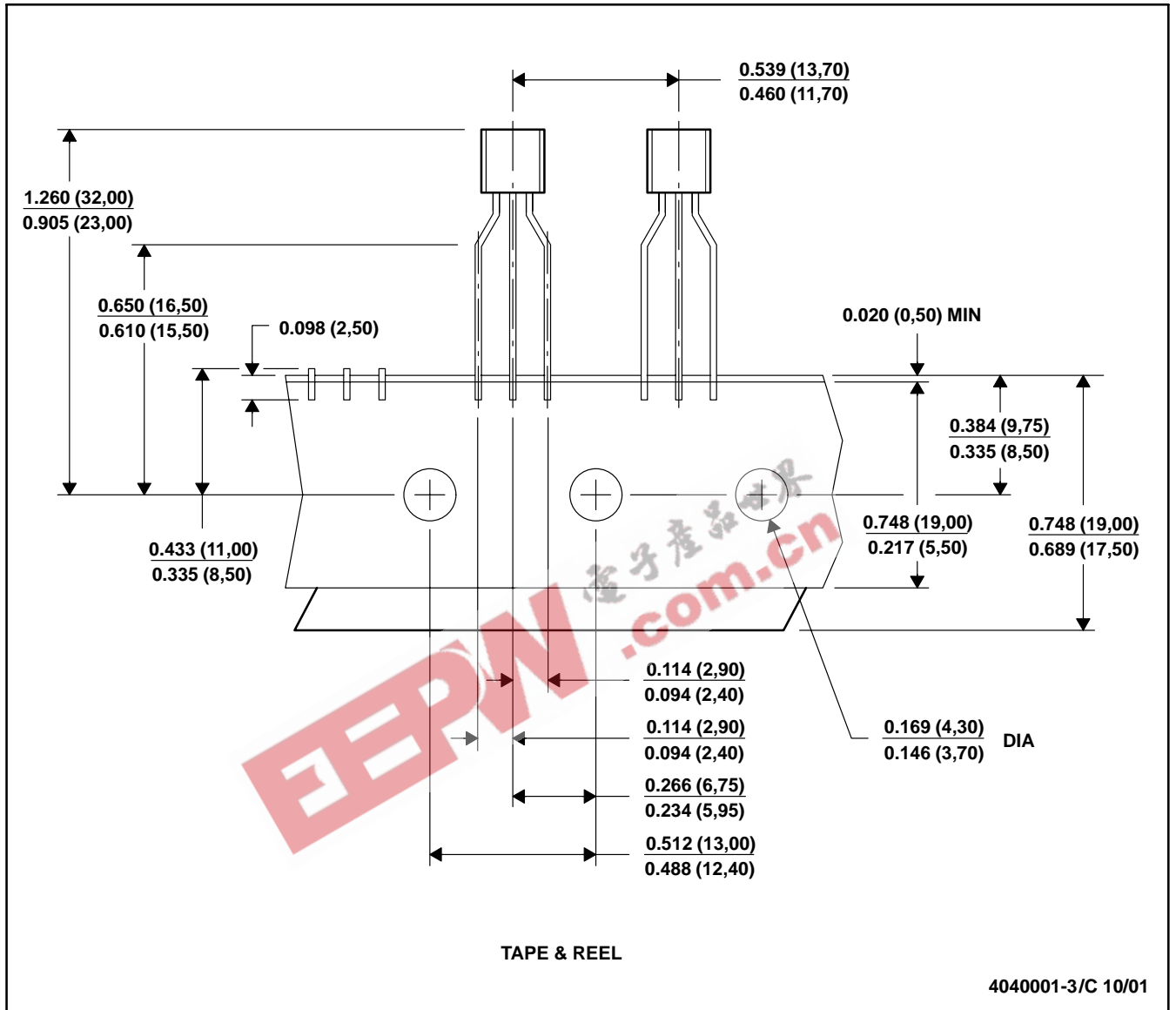

- NOTES:
- All linear dimensions are in inches (millimeters).
  - This drawing is subject to change without notice.
  - Tape and Reel information for the Format Lead Option package.

## IMPORTANT NOTICE

Texas Instruments Incorporated and its subsidiaries (TI) reserve the right to make corrections, modifications, enhancements, improvements, and other changes to its products and services at any time and to discontinue any product or service without notice. Customers should obtain the latest relevant information before placing orders and should verify that such information is current and complete. All products are sold subject to TI's terms and conditions of sale supplied at the time of order acknowledgment.

TI warrants performance of its hardware products to the specifications applicable at the time of sale in accordance with TI's standard warranty. Testing and other quality control techniques are used to the extent TI deems necessary to support this warranty. Except where mandated by government requirements, testing of all parameters of each product is not necessarily performed.

TI assumes no liability for applications assistance or customer product design. Customers are responsible for their products and applications using TI components. To minimize the risks associated with customer products and applications, customers should provide adequate design and operating safeguards.

TI does not warrant or represent that any license, either express or implied, is granted under any TI patent right, copyright, mask work right, or other TI intellectual property right relating to any combination, machine, or process in which TI products or services are used. Information published by TI regarding third-party products or services does not constitute a license from TI to use such products or services or a warranty or endorsement thereof. Use of such information may require a license from a third party under the patents or other intellectual property of the third party, or a license from TI under the patents or other intellectual property of TI.

Reproduction of TI information in TI data books or data sheets is permissible only if reproduction is without alteration and is accompanied by all associated warranties, conditions, limitations, and notices. Reproduction of this information with alteration is an unfair and deceptive business practice. TI is not responsible or liable for such altered documentation. Information of third parties may be subject to additional restrictions.

Resale of TI products or services with statements different from or beyond the parameters stated by TI for that product or service voids all express and any implied warranties for the associated TI product or service and is an unfair and deceptive business practice. TI is not responsible or liable for any such statements.

TI products are not authorized for use in safety-critical applications (such as life support) where a failure of the TI product would reasonably be expected to cause severe personal injury or death, unless officers of the parties have executed an agreement specifically governing such use. Buyers represent that they have all necessary expertise in the safety and regulatory ramifications of their applications, and acknowledge and agree that they are solely responsible for all legal, regulatory and safety-related requirements concerning their products and any use of TI products in such safety-critical applications, notwithstanding any applications-related information or support that may be provided by TI. Further, Buyers must fully indemnify TI and its representatives against any damages arising out of the use of TI products in such safety-critical applications.

TI products are neither designed nor intended for use in military/aerospace applications or environments unless the TI products are specifically designated by TI as military-grade or "enhanced plastic." Only products designated by TI as military-grade meet military specifications. Buyers acknowledge and agree that any such use of TI products which TI has not designated as military-grade is solely at the Buyer's risk, and that they are solely responsible for compliance with all legal and regulatory requirements in connection with such use.

TI products are neither designed nor intended for use in automotive applications or environments unless the specific TI products are designated by TI as compliant with ISO/TS 16949 requirements. Buyers acknowledge and agree that, if they use any non-designated products in automotive applications, TI will not be responsible for any failure to meet such requirements.

Following are URLs where you can obtain information on other Texas Instruments products and application solutions:

Products		Applications	
Amplifiers	<a href="http://amplifier.ti.com">amplifier.ti.com</a>	Audio	<a href="http://www.ti.com/audio">www.ti.com/audio</a>
Data Converters	<a href="http://dataconverter.ti.com">dataconverter.ti.com</a>	Automotive	<a href="http://www.ti.com/automotive">www.ti.com/automotive</a>
DSP	<a href="http://dsp.ti.com">dsp.ti.com</a>	Broadband	<a href="http://www.ti.com/broadband">www.ti.com/broadband</a>
Interface	<a href="http://interface.ti.com">interface.ti.com</a>	Digital Control	<a href="http://www.ti.com/digitalcontrol">www.ti.com/digitalcontrol</a>
Logic	<a href="http://logic.ti.com">logic.ti.com</a>	Military	<a href="http://www.ti.com/military">www.ti.com/military</a>
Power Mgmt	<a href="http://power.ti.com">power.ti.com</a>	Optical Networking	<a href="http://www.ti.com/opticalnetwork">www.ti.com/opticalnetwork</a>
Microcontrollers	<a href="http://microcontroller.ti.com">microcontroller.ti.com</a>	Security	<a href="http://www.ti.com/security">www.ti.com/security</a>
RFID	<a href="http://www.ti-rfid.com">www.ti-rfid.com</a>	Telephony	<a href="http://www.ti.com/telephony">www.ti.com/telephony</a>
Low Power Wireless	<a href="http://www.ti.com/lpw">www.ti.com/lpw</a>	Video & Imaging	<a href="http://www.ti.com/video">www.ti.com/video</a>
		Wireless	<a href="http://www.ti.com/wireless">www.ti.com/wireless</a>

Mailing Address: Texas Instruments, Post Office Box 655303, Dallas, Texas 75265  
Copyright © 2007, Texas Instruments Incorporated