

LM5112 Tiny 7A MOSFET Gate Driver

General Description

The LM5112 MOSFET gate driver provides high peak gate drive current in the tiny LLP-6 package (SOT23 equivalent footprint) with improved package power dissipation required for high frequency operation. The compound output driver stage includes MOS and bipolar transistors operating in parallel that together sink more than 7A peak from capacitive loads. Combining the unique characteristics of MOS and bipolar devices reduces drive current variation with voltage and temperature. Under-voltage lockout protection is provided to prevent damage to the MOSFET due to insufficient gate turn-on voltage. The LM5112 provides both inverting and non-inverting gate drive with a single device type.

Features

- Compound CMOS and bipolar outputs reduce output current variation
- 7A sink/3A source current
- Fast propagation times (25 ns typical)
- Fast rise and fall times (14 ns/12 ns rise/fall with 2 nF load)
- Inverting and non-inverting inputs provide either configuration with a single device
- Supply rail under-voltage lockout protection
- Dedicated input ground (IN_REF) for split supply or single supply operation
- Power Enhanced 6-pin LLP package (3.0mm x 3.0mm)
- Output swings from V_{CC} to V_{EE} which can be negative relative to input ground.

Block Diagram

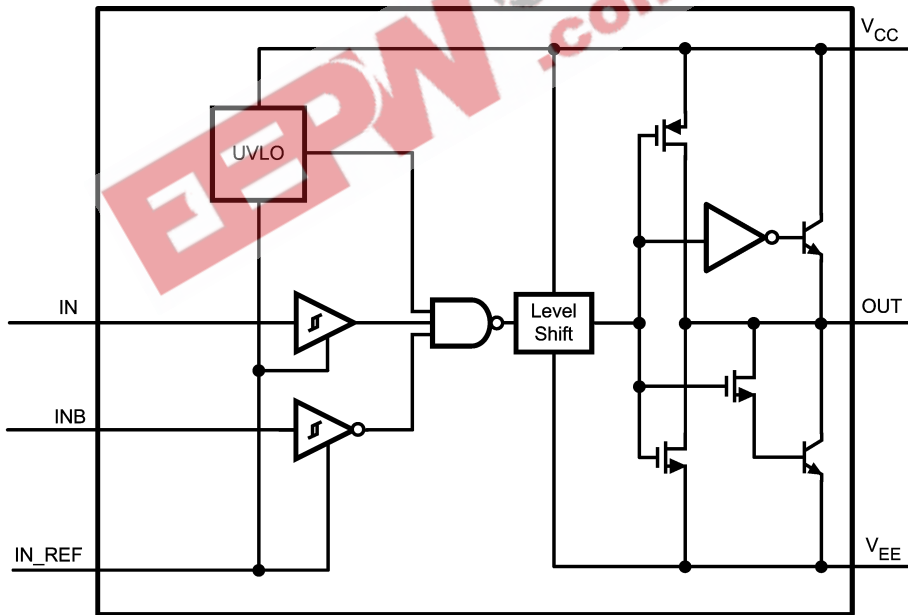

Block Diagram of LM5112

20066801

Pin Configurations

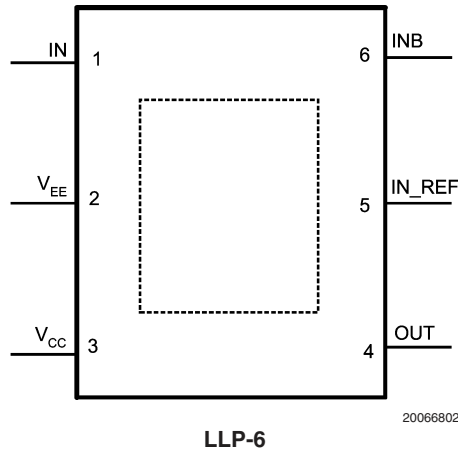

Ordering Information

Order Number	Package Type	NSC Package Drawing	Supplied As
LM5112-SD	LLP-6	SDE06A	1000 shipped in Tape & Reel
LM5112-SDX	LLP-6	SDE06A	4500 shipped in Tape & Reel

Pin Description

Pin	Name	Description	Application Information
1	IN	Non-inverting input pin	TTL compatible thresholds. Pull up to V_{CC} when not used
2	V_{EE}	Power ground for driver outputs	Connect to either power ground or a negative gate drive supply for positive or negative voltage swing
3	V_{CC}	Positive Supply voltage input	Locally decouple to V_{EE} . The decoupling capacitor should be located close to the chip
4	OUT	Gate drive output	Capable of sourcing 3A and sinking 7A. Voltage swing of this output is from V_{EE} to V_{CC}
5	IN_REF	Ground reference for control inputs	Connect to power ground (V_{EE}) for standard positive only output voltage swing. Connect to system logic ground when V_{EE} is connected to a negative gate drive supply
6	INB	Inverting input pin	TTL compatible thresholds. Connect to IN_REF when not used
- - -	Exposed Pad	Exposed Pad, underside of LLP package	Internally bonded to the die substrate. Connect to V_{EE} ground pin for low thermal impedance

Absolute Maximum Ratings (Note 1)

If Military/Aerospace specified devices are required, please contact the National Semiconductor Sales Office/Distributors for availability and specifications.

V_{CC} to V_{EE}	-0.3V to 15V
V_{CC} to IN_REF	-0.3V to 15V
IN/INB to IN_REF	-0.3V to 15V

IN_REF to V_{EE}	-0.3V to 5V
Storage Temperature Range	-55°C to +150°C
Maximum Junction Temperature	+150°C
Operating Junction Temperature	-40°C to +125°C
ESD Rating	2kV

Electrical Characteristics $T_J = -40^\circ\text{C}$ to $+125^\circ\text{C}$, $V_{CC} = 12\text{V}$, $INB = IN_REF = V_{EE} = 0\text{V}$, No Load on output, unless otherwise specified.

SYMBOL	PARAMETER	CONDITIONS	MIN	TYP	MAX	UNITS
SUPPLY						
V_{CC}	V_{CC} operating range	$V_{CC} - IN_REF$ and $V_{CC} - V_{EE}$	3.5		14	V
UVLO	V_{CC} Under-voltage lockout (rising)	$V_{CC} - IN_REF$	2.4	3.0	3.5	V
V_{CCH}	V_{CC} Under-voltage hysteresis			230		mV
I_{CC}	V_{CC} supply current			1.0	2.0	mA
CONTROL INPUTS						
V_{IH}	Logic High			1.75	2.3	V
V_{IL}	Logic low		0.8	1.35		V
HYS	Input Hysteresis			400		mV
I_{IL}	Input Current Low	$IN = INB = 0\text{V}$	-1	0.1	1	μA
I_{IH}	Input Current High	$IN = INB = V_{CC}$	-1	0.1	1	μA
OUTPUT DRIVER						
R_{OH}	Output Resistance High	$I_{OUT} = -10\text{mA}$		30	50	Ω
R_{OL}	Output Resistance Low	$I_{OUT} = 10\text{mA}$		1.4	2.5	Ω
I_{SOURCE}	Peak Source Current	$OUT = V_{CC}/2$, 200ns pulsed current		3		A
I_{SINK}	Peak Sink Current	$OUT = V_{CC}/2$, 200ns pulsed current		7		A
SWITCHING CHARACTERISTICS						
td1	Propagation Delay Time Low to High, IN/INB rising (IN to OUT)	$C_{LOAD} = 2\text{ nF}$, see Figure 3		25	40	ns
td2	Propagation Delay Time High to Low, IN/INB falling (IN to OUT)	$C_{LOAD} = 2\text{ nF}$, see Figure 3		25	40	ns
tr	Rise time	$C_{LOAD} = 2\text{ nF}$, see Figure 3		14		ns
tf	Fall time	$C_{LOAD} = 2\text{ nF}$, see Figure 3		12		ns
LATCHUP PROTECTION						
	AEC -Q100, METHOD 004	$T_J = 150^\circ\text{C}$		500		mA

Note 1: Absolute Maximum Ratings are limits beyond which damage to the device may occur. Operating Ratings are conditions under which operation of the device is intended to be functional. For guaranteed specifications and test conditions, see the Electrical Characteristics.

Timing Waveforms

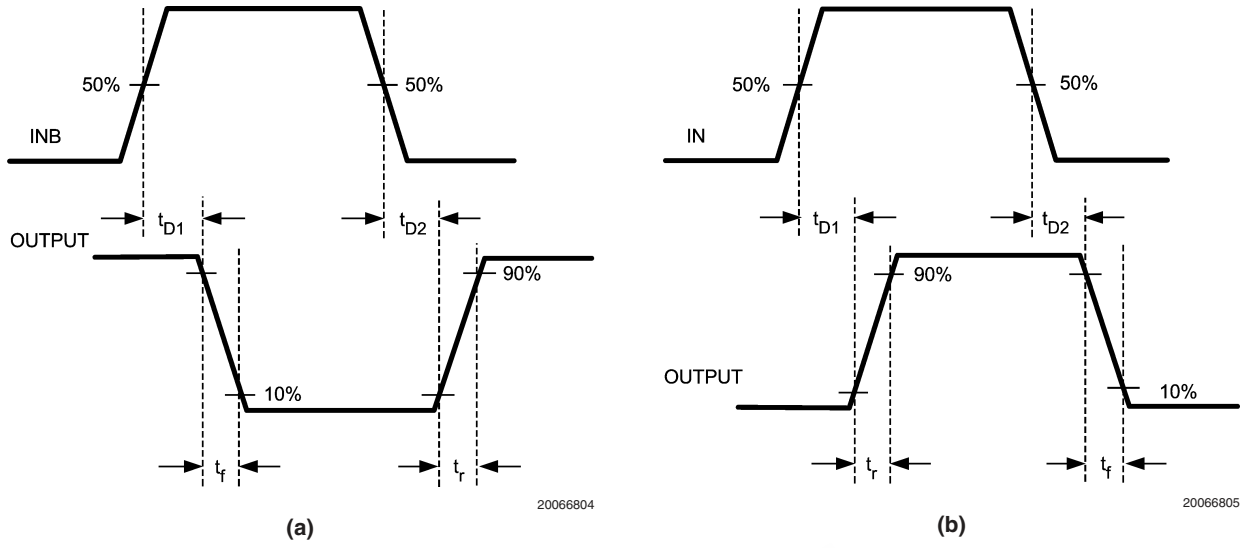
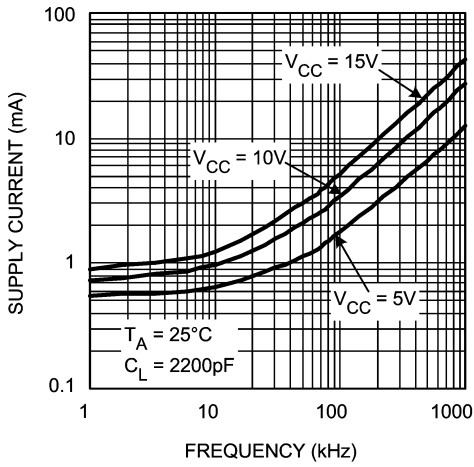

FIGURE 1. (a) Inverting, (b) Non-Inverting

EEPW.com.cn 电子产品世界

Typical Performance Characteristics

Supply Current vs Frequency



20066807

Supply Current vs Capacitive Load

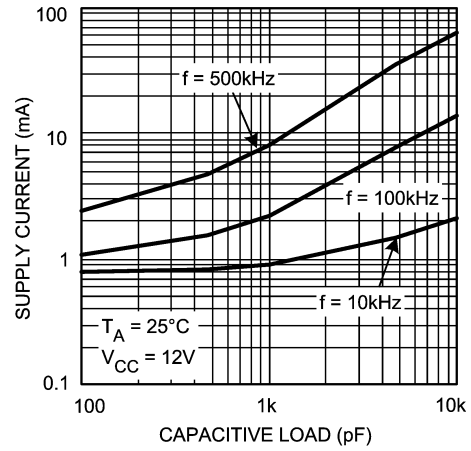

20066808

Rise and Fall Time vs Supply Voltage

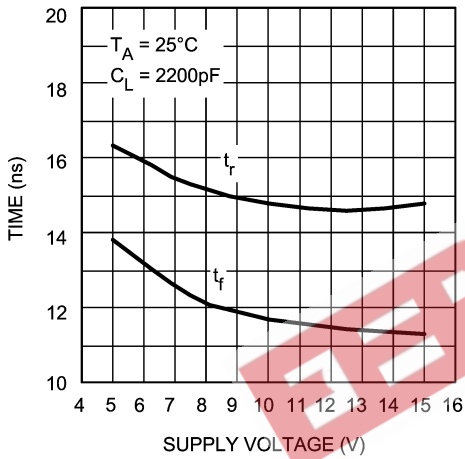

20066809

Rise and Fall Time vs Temperature

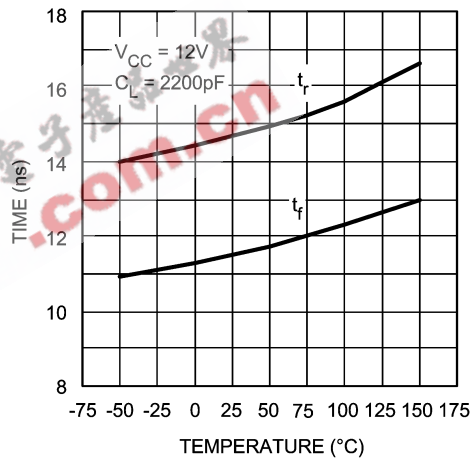

20066810

Rise and Fall Time vs Capacitive Load

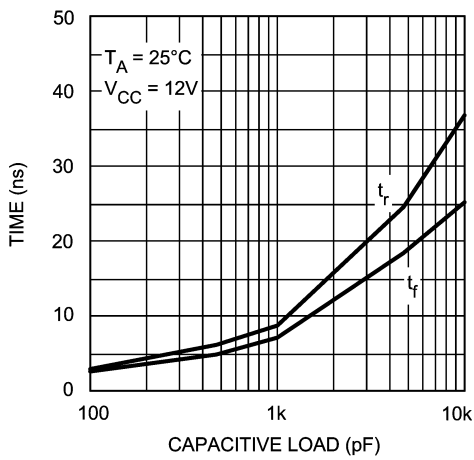

20066811

Delay Time vs Supply Voltage

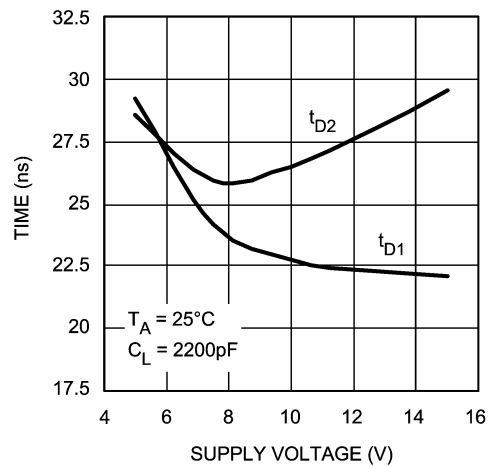

20066812

Typical Performance Characteristics (Continued)

Delay Time vs Temperature

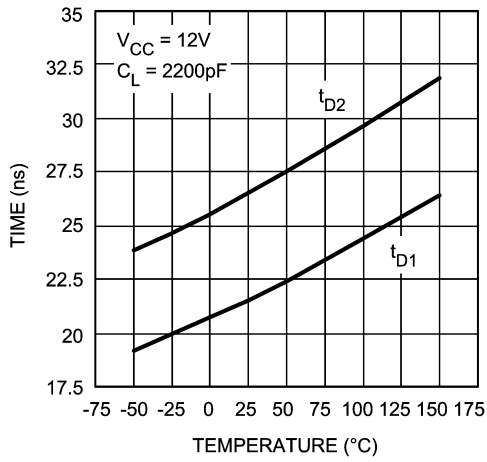

20066813

RDSON vs Supply Voltage

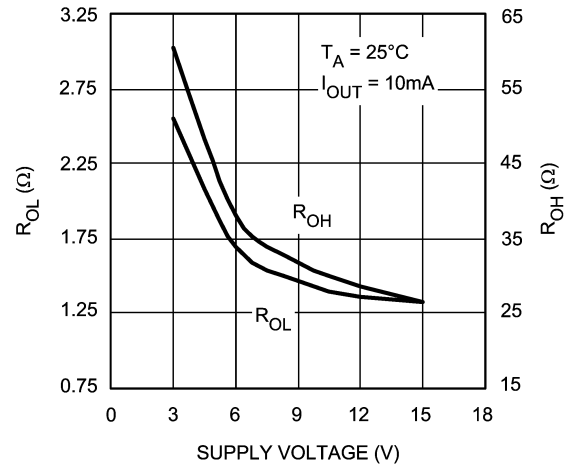

20066814

UVLO Thresholds and Hysteresis vs Temperature

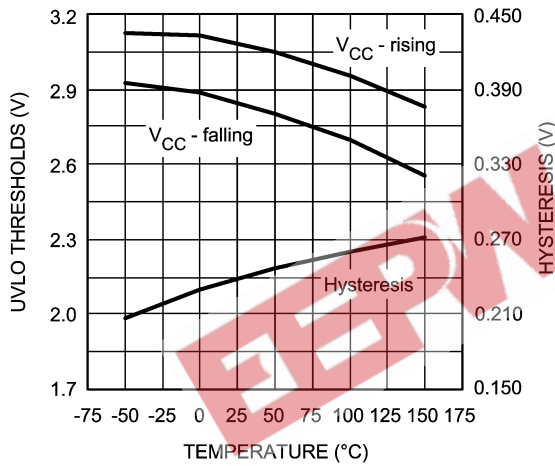

20066815

Peak Current vs Supply Voltage

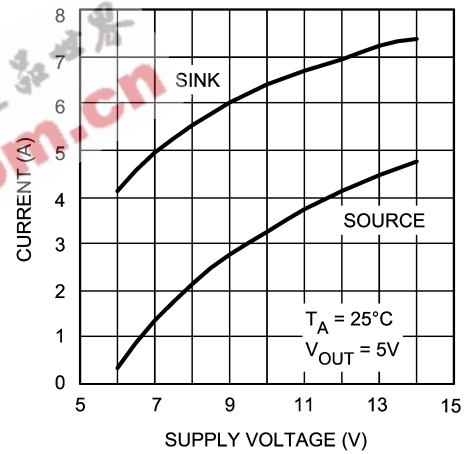

20066816

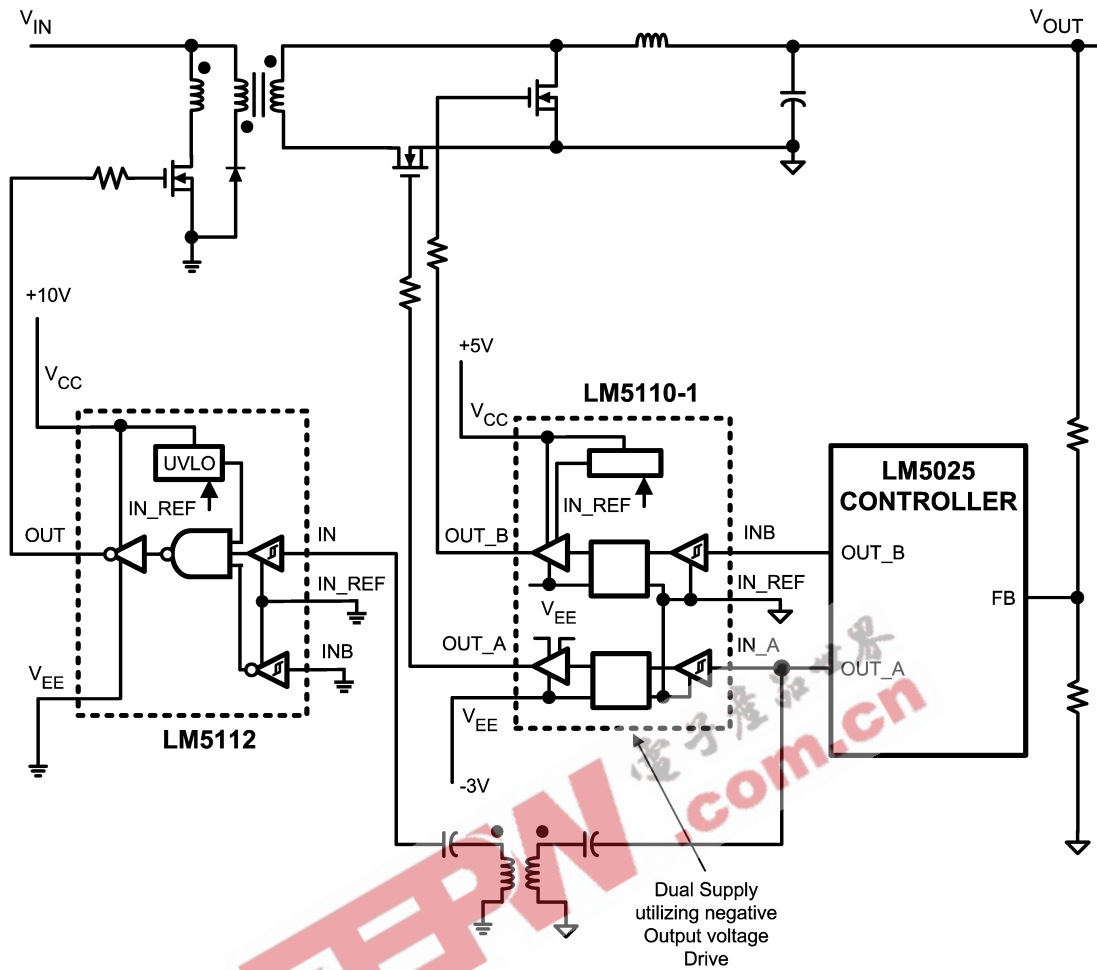

20066803

FIGURE 2. Simplified Application Block Diagram

Detailed Operating Description

The LM5112 is a high speed, high peak current (7A) single channel MOSFET driver. The high peak output current of the LM5112 will switch power MOSFET's on and off with short rise and fall times, thereby reducing switching losses considerably. The LM5112 includes both inverting and non-inverting inputs that give the user flexibility to drive the MOSFET with either active low or active high logic signals. The driver output stage consists of a compound structure with MOS and bipolar transistor operating in parallel to optimize current capability over a wide output voltage and operating temperature range. The bipolar device provides high peak current at the critical Miller plateau region of the MOSFET V_{GS} , while the MOS device provides rail-to-rail output swing. The totem pole output drives the MOSFET gate between the gate drive supply voltage V_{CC} and the power ground potential at the V_{EE} pin.

The control inputs of the driver are high impedance CMOS buffers with TTL compatible threshold voltages. The negative supply of the input buffer is connected to the input ground pin IN_REF . An internal level shifting circuit connects the logic input buffers to the totem pole output drivers. The level shift circuit and separate input/output ground pins provide the option of single supply or split supply configurations.

When driving the MOSFET gates from a single positive supply, the IN_REF and V_{EE} pins are both connected to the power ground.

The isolated input and output stage grounds provide the capability to drive the MOSFET to a negative V_{GS} voltage for a more robust and reliable off state. In split supply configuration, the IN_REF pin is connected to the ground of the controller which drives the LM5112 inputs. The V_{EE} pin is connected to a negative bias supply that can range from the IN_REF potential to as low as 14 V below the V_{CC} gate drive supply. For reliable operation, the maximum voltage difference between V_{CC} and IN_REF or between V_{CC} and V_{EE} is 14V.

The minimum recommended operating voltage between V_{CC} and IN_REF is 3.5V. An Under Voltage Lock Out (UVLO) circuit is included in the LM5112 which senses the voltage difference between V_{CC} and the input ground pin, IN_REF . When the V_{CC} to IN_REF voltage difference falls below 2.8V the driver is disabled and the output pin is held in the low state. The UVLO hysteresis prevents chattering during brown-out conditions; the driver will resume normal operation when the V_{CC} to IN_REF differential voltage exceeds 3.0V.

Layout Considerations

Attention must be given to board layout when using LM5112. Some important considerations include:

1. A Low ESR/ESL capacitor must be connected close to the IC and between the V_{CC} and V_{EE} pins to support high peak currents being drawn from V_{CC} during turn-on of the MOSFET.
2. Proper grounding is crucial. The driver needs a very low impedance path for current return to ground avoiding inductive loops. Two paths for returning current to ground are a) between LM5112 IN_REF pin and the ground of the circuit that controls the driver inputs and b) between LM5112 V_{EE} pin and the source of the power MOSFET being driven. Both paths should be as short as possible to reduce inductance and be as wide as possible to reduce resistance. These ground paths should be distinctly separate to avoid coupling between the high current output paths and the logic signals that drive the LM5112. With rise and fall times in the range of 10 to 30nsec, care is required to minimize the lengths of current carrying conductors to reduce their inductance and EMI from the high di/dt transients generated when driving large capacitive loads.
3. If either channel is not being used, the respective input pin (IN or INB) should be connected to either V_{EE} or V_{CC} to avoid spurious output signals.

Thermal Performance

INTRODUCTION

The primary goal of the thermal management is to maintain the integrated circuit (IC) junction temperature (T_J) below a specified limit to ensure reliable long term operation. The maximum T_J of IC components should be estimated in worst case operating conditions. The junction temperature can be calculated based on the power dissipated on the IC and the junction to ambient thermal resistance θ_{JA} for the IC package in the application board and environment. The θ_{JA} is not a given constant for the package and depends on the PCB design and the operating environment.

DRIVE POWER REQUIREMENT CALCULATIONS IN LM5112

LM5112 is a single low side MOSFET driver capable of sourcing / sinking 3A / 7A peak currents for short intervals to drive a MOSFET without exceeding package power dissipation limits. High peak currents are required to switch the MOSFET gate very quickly for operation at high frequencies.

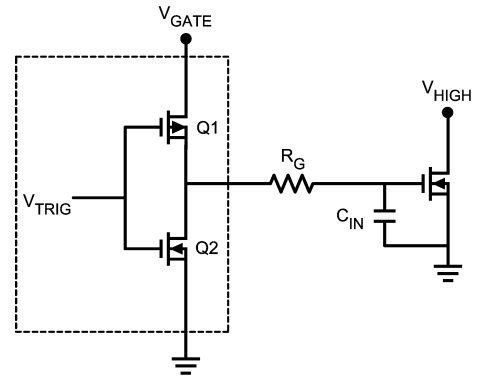

20066806

FIGURE 3.

The schematic above shows a conceptual diagram of the LM5112 output and MOSFET load. Q1 and Q2 are the switches within the gate driver. R_G is the gate resistance of the external MOSFET, and C_{in} is the equivalent gate capacitance of the MOSFET. The equivalent gate capacitance is a difficult parameter to measure as it is the combination of C_{gs} (gate to source capacitance) and C_{gd} (gate to drain capacitance). The C_{gd} is not a constant and varies with the drain voltage. The better way of quantifying gate capacitance is the gate charge Q_g in coulombs. Q_g combines the charge required by C_{gs} and C_{gd} for a given gate drive voltage V_{gate} . The gate resistance R_g is usually very small and losses in it can be neglected. The total power dissipated in the MOSFET driver due to gate charge is approximated by:

$$P_{DRIVER} = V_{GATE} \times Q_G \times F_{SW}$$

Where

F_{SW} = switching frequency of the MOSFET.

For example, consider the MOSFET MTD6N15 whose gate charge specified as 30 nC for $V_{GATE} = 12V$.

Therefore, the power dissipation in the driver due to charging and discharging of MOSFET gate capacitances at switching frequency of 300 kHz and V_{GATE} of 12V is equal to

$$P_{DRIVER} = 12V \times 30 \text{ nC} \times 300 \text{ kHz} = 0.108W.$$

In addition to the above gate charge power dissipation, - transient power is dissipated in the driver during output transitions. When either output of the LM5112 changes state, current will flow from V_{CC} to V_{EE} for a very brief interval of time through the output totem-pole N and P channel MOSFETs. The final component of power dissipation in the driver is the power associated with the quiescent bias current consumed by the driver input stage and Under-voltage lockout sections.

Characterization of the LM5112 provides accurate estimates of the transient and quiescent power dissipation components. At 300 kHz switching frequency and 30 nC load used in the example, the transient power will be 8 mW. The 1 mA nominal quiescent current and 12V V_{GATE} supply produce a 12 mW typical quiescent power.

Therefore the total power dissipation

$$P_D = 0.118 + 0.008 + 0.012 = 0.138W.$$

We know that the junction temperature is given by

$$T_J = P_D \times \theta_{JA} + T_A$$

Or the rise in temperature is given by

$$T_{RISE} = T_J - T_A = P_D \times \theta_{JA}$$

Thermal Performance (Continued)

For LLP-6 package, the integrated circuit die is attached to leadframe die pad which is soldered directly to the printed circuit board. This substantially decreases the junction to ambient thermal resistance (θ_{JA}). By providing suitable means of heat dispersion from the IC to the ambient through

exposed copper pad, which can readily dissipate heat to the surroundings, θ_{JA} as low as $40^{\circ}\text{C} / \text{Watt}$ is achievable with the package. The resulting Trise for the driver example above is thereby reduced to just 5.5 degrees.

Therefore T_{RISE} is equal to

$$T_{RISE} = 0.138 \times 40 = 5.5^{\circ}\text{C}$$

EEPW 电子产品世界
.com.cn

Physical Dimensions inches (millimeters)
unless otherwise noted

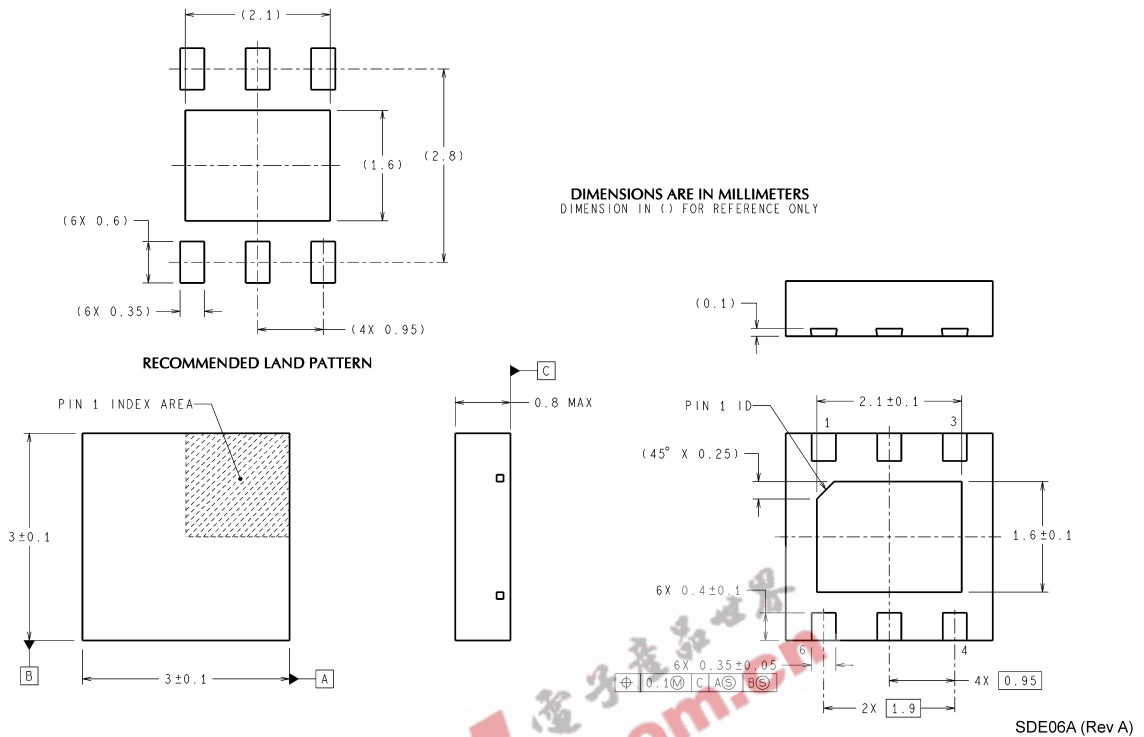

National does not assume any responsibility for use of any circuitry described, no circuit patent licenses are implied and National reserves the right at any time without notice to change said circuitry and specifications.

For the most current product information visit us at www.national.com.

LIFE SUPPORT POLICY

NATIONAL'S PRODUCTS ARE NOT AUTHORIZED FOR USE AS CRITICAL COMPONENTS IN LIFE SUPPORT DEVICES OR SYSTEMS WITHOUT THE EXPRESS WRITTEN APPROVAL OF THE PRESIDENT AND GENERAL COUNSEL OF NATIONAL SEMICONDUCTOR CORPORATION. As used herein:

1. Life support devices or systems are devices or systems which, (a) are intended for surgical implant into the body, or (b) support or sustain life, and whose failure to perform when properly used in accordance with instructions for use provided in the labeling, can be reasonably expected to result in a significant injury to the user.
2. A critical component is any component of a life support device or system whose failure to perform can be reasonably expected to cause the failure of the life support device or system, or to affect its safety or effectiveness.

BANNED SUBSTANCE COMPLIANCE

National Semiconductor certifies that the products and packing materials meet the provisions of the Customer Products Stewardship Specification (CSP-9-111C2) and the Banned Substances and Materials of Interest Specification (CSP-9-111S2) and contain no "Banned Substances" as defined in CSP-9-111S2.

National Semiconductor
Americas Customer Support Center
Email: new.feedback@nsc.com
Tel: 1-800-272-9959

www.national.com

National Semiconductor
Europe Customer Support Center
Fax: +49 (0) 180-530 85 86
Email: europe.support@nsc.com
Deutsch Tel: +49 (0) 69 9508 6208
English Tel: +44 (0) 870 24 0 2171
Français Tel: +33 (0) 1 41 91 8790

National Semiconductor
Asia Pacific Customer Support Center
Email: ap.support@nsc.com

National Semiconductor
Japan Customer Support Center
Fax: 81-3-5639-7507
Email: jpn.feedback@nsc.com
Tel: 81-3-5639-7560