



## LM2940

## LINEAR INTEGRATED CIRCUIT

### 1A LOW-DROPOUT POSITIVE VOLTAGE REGULATOR

#### DESCRIPTION

The UTC **LM2940** is a low dropout regulator designed to provide output current up to 1A with a typically 500mV dropout Voltage and a maximum of 1V. It is capable of reducing the ground current when the differential between the input voltage and the output voltage outrun 3V.

UTC LM2940 offers low quiescent current (typically 30mA at 1A and an input-output differential of 5V). Higher quiescent currents only exist when the regulator is in the dropout mode ( $V_{IN}-V_{OUT} \leq 3V$ ).

#### FEATURES

- \* 500mV typically dropout at 1A
- \* Output current in excess of 1A
- \* Low quiescent current
- \* Reversed-battery protection
- \* Current limit and thermal shutdown.
- \* Mirror image insertion protection

#### ORDERING INFORMATION

Order Number		Package	Pin Assignment			Packing
Normal	Lead Free Plating		1	2	3	
LM2940-xx-AA3- R	LM2940L-xx-AA3-R	SOT-223	I	G	O	Tape Reel
LM2940-xx-TA3-T	LM2940L-xx-TA3-T	TO-220	I	G	O	Tube
LM2940-xx-TN3-R	LM2940L-xx-TN3-R	TO-252	I	G	O	Tape Reel
LM2940-xx-TN3-T	LM2940L-xx-TN3-T	TO-252	I	G	O	Tube
LM2940-xx-TQ2-R	LM2940L-xx-TQ2-R	TO-263	I	G	O	Tape Reel
LM2940-xx-TQ2-T	LM2940L-xx-TQ2-T	TO-263	I	G	O	Tube
LM2940-xx-TQ3-R	LM2940L-xx-TQ3-R	TO-263-3	I	G	O	Tape Reel
LM2940-xx-TQ3-T	LM2940L-xx-TQ3-T	TO-263-3	I	G	O	Tube

Note: 1.xx: output voltage, refer to Marking Information.

2.Pin Assignment: I:  $V_{IN}$  G: GND O:  $V_{OUT}$

<p>LM2940L-xx-AA3-R</p> <p>(1)Packing Type (2)Package Type (3)Output Voltage Code (4)Lead Plating</p>	<p>(1) R: Tape Reel, T: Tube (2) AA3: SOT-223, TA3: TO-220, TN3: TO-252, TQ2: TO-263, TQ3: TO-263-3 (3) xx: refer to Marking Information (4) L: Lead Free Plating, Blank: Pb/Sn</p>
---	---

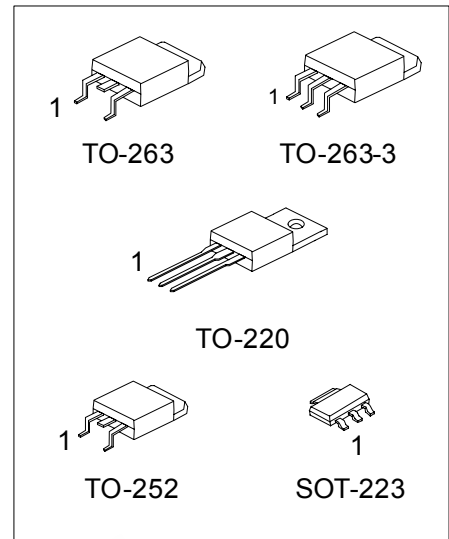

\*Pb-free plating product number: LM2940L

### MARKING INFORMATION

PACKAGE	VOLTAGE CODE	MARKING
SOT-223	10 : 10V 12 : 12V 15 : 15V	
TO-220 TO-252 TO-263 TO-263-3	50 : 5V 80 : 8V 90 : 9V	

EEPW.com.cn 電子產品世界

### ■ ABSOLUTE MAXIMUM RATINGS

PARAMETER	SYMBOL	RATINGS	UNIT
Input Voltage	$V_{IN}$	26	V
Power Dissipation	$P_D$	Internally limited	
Junction Temperature	$T_J$	+150	°C
Operating Temperature	TO-220/TO-263-3/TO-263	-40 ~ +125	°C
	SOT-223	-40 ~ +85	°C
Storage temperature	$T_{STG}$	-65 ~ +150	°C

Note Absolute maximum ratings are those values beyond which the device could be permanently damaged. Absolute maximum ratings are stress ratings only and functional device operation is not implied.

### ■ ELECTRICAL CHARACTERISTICS

( $T_a=T_J=25^\circ\text{C}$ ,  $V_{IN}=V_{OUT}+5\text{V}$ ,  $I_{OUT}=1\text{A}$  and  $C_{OUT}=22\mu\text{F}$ , unless otherwise specified.)

#### For LM2940-5.0V

PARAMETER	SYMBOL	TEST CONDITIONS	MIN	TYP	MAX	UNIT
Output Voltage	$V_{OUT}$	$6.25\text{V} \leq V_{IN} \leq 26\text{V}$ , $5\text{mA} \leq I_{OUT} \leq 1\text{A}$	4.85	5.00	5.15	V
Line Regulation	$V_{OUT}$	$V_{OUT}+2\text{V} \leq V_{IN} \leq 26\text{V}$ , $I_{OUT}=5\text{mA}$		20	50	mV
Load Regulation	$V_{OUT}$	$50\text{mA} \leq I_{OUT} \leq 1\text{A}$		35	50	mV
Output Impedance	$R_o$	100 mA DC and 20mArms, $f_o=120\text{Hz}$		35		$\text{m}\Omega$
Quiescent Current	$I_Q$	$V_{OUT}+2\text{V} \leq V_{IN} \leq 26\text{V}$ , $I_{OUT}=5\text{mA}$		10	15	mA
Output Noise Voltage	eN	10Hz-100kHz, $I_{OUT}=5\text{mA}$		150		$\mu\text{Vrms}$
Ripple Rejection	RR	$f_o=120\text{Hz}$ , 1Vrms, $I_{OUT}=100\text{mA}$	60	72		dB
Long Term Stability				20		mV/1000Hr
Dropout Voltage	$V_D$	$I_{OUT}=1\text{A}$		0.5	0.8	V
		$I_{OUT}=100\text{mA}$		0.11	0.15	
Short Circuit Current	$I_{SC}$	(Note)	1.6	1.9		A
Maximum Line Transient	$T_{IN}$	$R_o=100\Omega$ , $T \leq 100\text{ms}$	60	75		V
Reverse Polarity DC Input Voltage	$V_{RIN}$	$R_o=100\Omega$	-15	-30		V
Reverse Polarity Transient Input Voltage	$V_{TRRI}$	$R_o=100\Omega$ , $T \leq 100\text{ms}$	-50	-75		V

#### For LM2940-8.0V

PARAMETER	SYMBOL	TEST CONDITIONS	MIN	TYP	MAX	UNIT
Output Voltage	$V_{OUT}$	$9.4\text{V} \leq V_{IN} \leq 26\text{V}$ , $5\text{mA} \leq I_{OUT} \leq 1\text{A}$	7.76	8.00	8.24	V
Line regulation	$V_{OUT}$	$V_{OUT} +2\text{V} \leq V_{IN} \leq 26\text{V}$ , $I_{OUT}=5\text{mA}$		20	80	mV
Load Regulation	$V_{OUT}$	$50\text{mA} \leq I_{OUT} \leq 1\text{A}$		55	80	mV
Output Impedance	$R_o$	100 mA DC and 20mArms, $f_o=120\text{Hz}$		55		$\text{m}\Omega$
Quiescent Current	$I_Q$	$V_{OUT} +2\text{V} \leq V_{IN} \leq 26\text{V}$ , $I_{OUT}=5\text{mA}$		10	15	mA
Output Noise Voltage	eN	10Hz-100kHz, $I_{OUT}=5\text{mA}$		240		$\mu\text{Vrms}$
Ripple Rejection	RR	$f_o=120\text{Hz}$ , 1Vrms, $I_{OUT}=100\text{mA}$	54	66		dB
Long Term Stability				32		mV/1000Hr
Dropout Voltage	$V_D$	$I_{OUT}=1\text{A}$		0.5	0.8	V
		$I_{OUT}=100\text{mA}$		0.11	0.15	
Short Circuit Current	$I_{SC}$	(Note)	1.6	1.9		A
Maximum Line Transient	$T_{IN}$	$R_o=100\Omega$ , $T \leq 100\text{ms}$	60	75		V
Reverse Polarity DC Input Voltage	$V_{RIN}$	$R_o=100\Omega$	-15	-30		V
Reverse Polarity Transient Input Voltage	$V_{TRRI}$	$R_o=100\Omega$ , $T \leq 100\text{ms}$	-50	-75		V

■ ELECTRICAL CHARACTERISTICS(Cont.)

For LM2940-9.0V

PARAMETER	SYMBOL	TEST CONDITIONS	MIN	TYP	MAX	UNIT
Output Voltage	$V_{OUT}$	$10.5V \leq V_{IN} \leq 26V, 5mA \leq I_{OUT} \leq 1A$	8.73	9.00	9.27	V
Line regulation	$V_{OUT}$	$V_{OUT} + 2V \leq V_{IN} \leq 26V, I_{OUT} = 5mA$		20	90	mV
Load Regulation	$V_{OUT}$	$50mA \leq I_{OUT} \leq 1A$		60	90	mV
Output Impedance	$R_o$	100 mA DC and 20mArms, $f_o=120Hz$		60		$m\Omega$
Quiescent Current	$I_Q$	$V_{OUT} + 2V \leq V_{IN} \leq 26V, I_{OUT} = 5mA$		10	15	mA
Output Noise Voltage	eN	10Hz-100kHz, $I_{OUT} = 5mA$		270		$\mu V_{rms}$
Ripple Rejection	RR	$f_o=120Hz, 1V_{rms}, I_{OUT} = 100mA$	52	64		dB
Long Term Stability				34		mV/ 1000Hr
Dropout Voltage	$V_D$	$I_{OUT} = 1A$		0.5	0.8	V
		$I_{OUT} = 100mA$		0.11	0.15	
Short Circuit Current	$I_{SC}$	(Note)	1.6	1.9		A
Maximum Line Transient	$T_{IN}$	$R_o=100\Omega, T \leq 100ms$	60	75		V
Reverse Polarity DC Input Voltage	$V_{RIN}$	$R_o=100\Omega$	-15	-30		V
Reverse Polarity Transient Input Voltage	$V_{TRRI}$	$R_o=100\Omega, T \leq 100ms$	-50	-75		V

For LM2940-10V

PARAMETER	SYMBOL	TEST CONDITIONS	MIN	TYP	MAX	UNIT
Output Voltage	$V_{OUT}$	$11.5V \leq V_{IN} \leq 26V, 5mA \leq I_{OUT} \leq 1A$	9.70	10.00	10.30	V
Line regulation	$V_{OUT}$	$V_{OUT} + 2V \leq V_{IN} \leq 26V, I_{OUT} = 5mA$		20	100	mV
Load Regulation	$V_{OUT}$	$50mA \leq I_{OUT} \leq 1A$		65	100	mV
Output Impedance	$R_o$	100 mA DC and 20mArms, $f_o=120Hz$		65		$m\Omega$
Quiescent Current	$I_Q$	$V_{OUT} + 2V \leq V_{IN} \leq 26V, I_{OUT} = 5mA$		10	15	mA
Output Noise Voltage	eN	10Hz-100kHz, $I_{OUT} = 5mA$		300		$\mu V_{rms}$
Ripple Rejection	RR	$f_o=120Hz, 1V_{rms}, I_{OUT} = 100mA$	51	63		dB
Long Term Stability				36		mV/ 1000Hr
Dropout Voltage	$V_D$	$I_{OUT} = 1A$		0.5	0.8	V
		$I_{OUT} = 100mA$		0.11	0.15	
Short Circuit Current	$I_{SC}$	(Note)	1.6	1.9		A
Maximum Line Transient	$T_{IN}$	$R_o=100\Omega, T \leq 100ms$	60	75		V
Reverse Polarity DC Input Voltage	$V_{RIN}$	$R_o=100\Omega$	-15	-30		V
Reverse Polarity Transient Input Voltage	$V_{TRRI}$	$R_o=100\Omega, T \leq 100ms$	-50	-75		V

■ ELECTRICAL CHARACTERISTICS(Cont.)

**UTC LM2940-12V**

PARAMETER	SYMBOL	TEST CONDITIONS	MIN	TYP	MAX	UNIT
Output Voltage	$V_{OUT}$	$13.6V \leq V_{IN} \leq 26V, 5mA \leq I_{OUT} \leq 1A$	11.64	12.00	12.36	V
Line regulation	$V_{OUT}$	$V_{OUT} + 2V \leq V_{IN} \leq 26V, I_{OUT} = 5mA$		20	120	mV
Load Regulation	$V_{OUT}$	$50mA \leq I_{OUT} \leq 1A$		55	120	mV
Output Impedance	$R_o$	100 mADC and 20mArms, $f_o=120Hz$		80		m $\Omega$
Quiescent Current	$I_Q$	$V_{OUT} + 2V \leq V_{IN} \leq 26V, I_{OUT} = 5mA$		10	15	mA
Output Noise Voltage	eN	10Hz-100kHz, $I_{OUT} = 5mA$		360		$\mu V_{rms}$
Ripple Rejection	RR	$f_o=120Hz, 1V_{rms}, I_{OUT} = 100mA$	54	66		dB
Long Term Stability				48		mV/ 1000Hr
Dropout Voltage	$V_D$	$I_{OUT} = 1A$		0.5	0.8	V
		$I_{OUT} = 100mA$		0.11	0.15	
Short Circuit Current	$I_{SC}$	(Note)	1.6	1.9		A
Maximum Line Transient	$T_{IN}$	$R_o=100\Omega, T \leq 100ms$	60	75		V
Reverse Polarity DC Input Voltage	$V_{RIN}$	$R_o=100\Omega$	-15	-30		V
Reverse Polarity Transient Input Voltage	$V_{TRRI}$	$R_o=100\Omega, T \leq 100ms$	-50	-75		V

**UTC LM2940-15V**

PARAMETER	SYMBOL	TEST CONDITIONS	MIN	TYP	MAX	UNIT
Output Voltage	$V_{OUT}$	$16.75V \leq V_{IN} \leq 26V, 5mA \leq I_{OUT} \leq 1A$	14.55	15.00	15.45	V
Line regulation	$V_{OUT}$	$V_{OUT} + 2V \leq V_{IN} \leq 26V, I_{OUT} = 5mA$		20	150	mV
Load Regulation	$V_{OUT}$	$50mA \leq I_{OUT} \leq 1A$		70	150	mV
Output Impedance	$R_o$	100 mADC and 20mArms, $f_o=120Hz$		100		m $\Omega$
Quiescent Current	$I_Q$	$V_{OUT} + 2V \leq V_{IN} \leq 26V, I_{OUT} = 5mA$		10	15	mA
Output Noise Voltage	eN	10Hz-100kHz, $I_{OUT} = 5mA$		450		$\mu V_{rms}$
Ripple Rejection	RR	$f_o=120Hz, 1V_{rms}, I_{OUT} = 100mA$	52	64		dB
Long Term Stability				60		mV/ 1000Hr
Dropout Voltage	$V_D$	$I_{OUT} = 1A$		0.5	0.8	V
		$I_{OUT} = 100mA$		0.11	0.15	
Short Circuit Current	$I_{SC}$	(Note)	1.6	1.9		A
Maximum Line Transient	$T_{IN}$	$R_o=100\Omega, T \leq 100ms$	60	75		V
Reverse Polarity DC Input Voltage	$V_{RIN}$	$R_o=100\Omega$	-15	-30		V
Reverse Polarity Transient Input Voltage	$V_{TRRI}$	$R_o=100\Omega, T \leq 100ms$	-50	-75		V

Note: Output current will decrease with temperature increase but will not drop below 1A at the maximum specified temperature.

## ■ TYPICAL APPLICATION

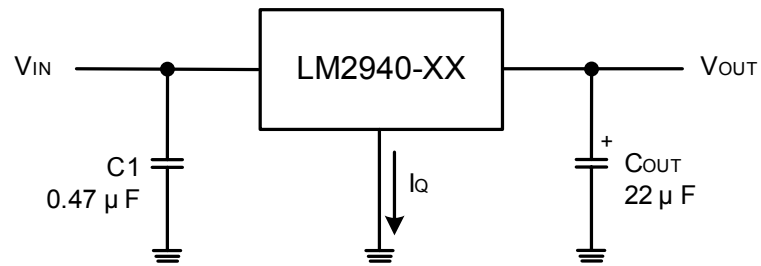

Note: 1.C1 is required if regulator is located far from power supply filter.

2.C<sub>OUT</sub> must be higher than 22μF for stability, and locate as close as possible to the regulator.

EEPW 電子產品世界  
.com.cn

### TYPICAL CHARACTERISTICS

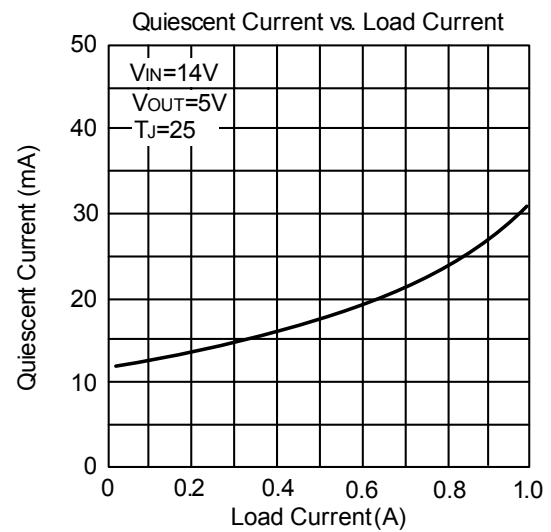
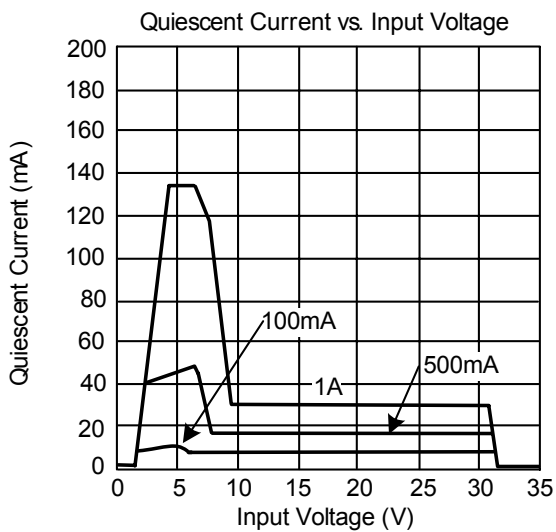
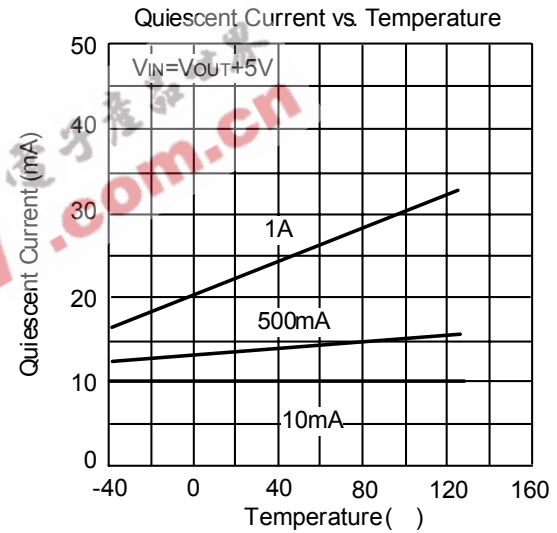
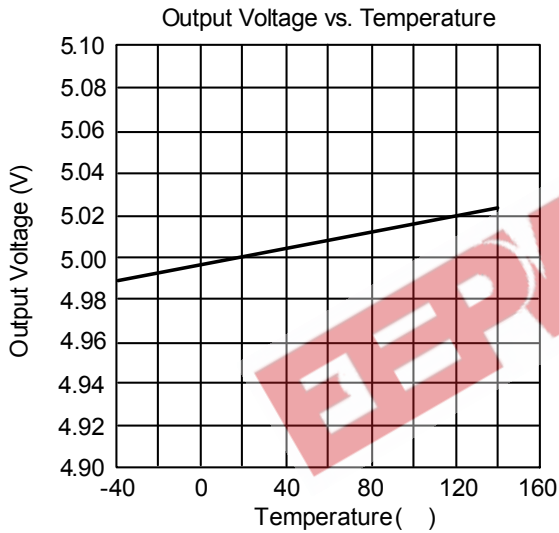
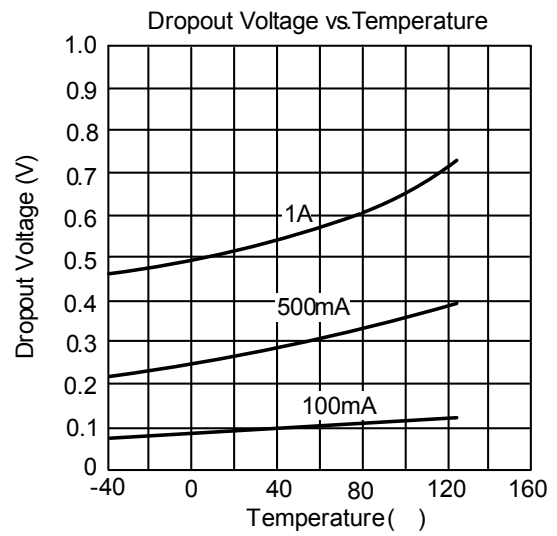
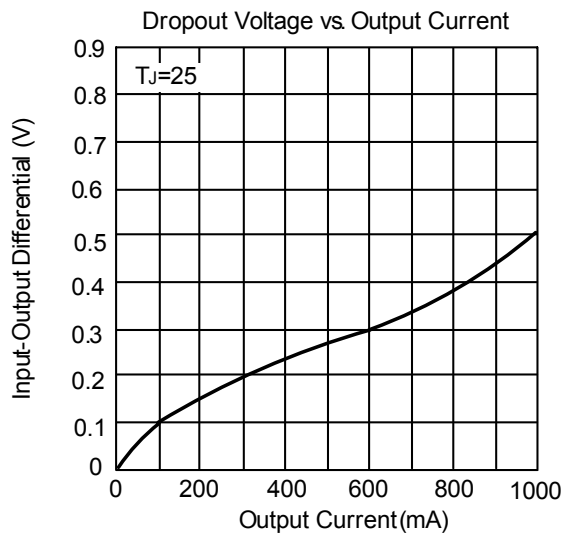

## TYPICAL CHARACTERISTICS (Cont.)

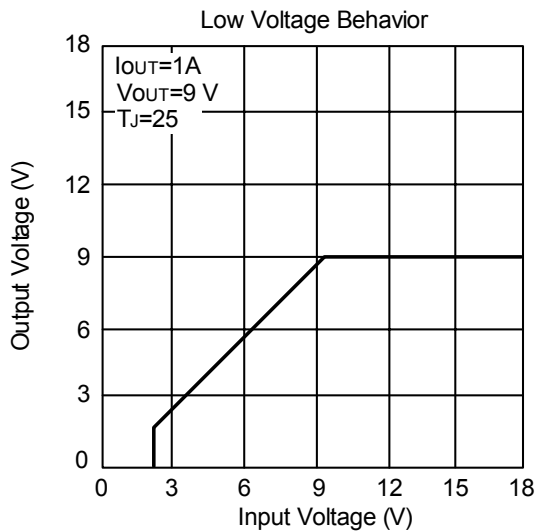
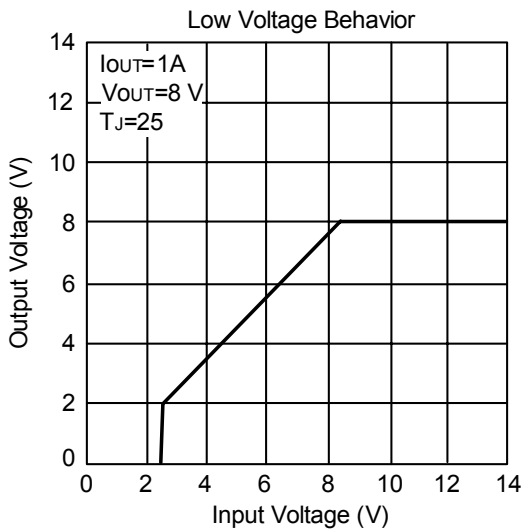
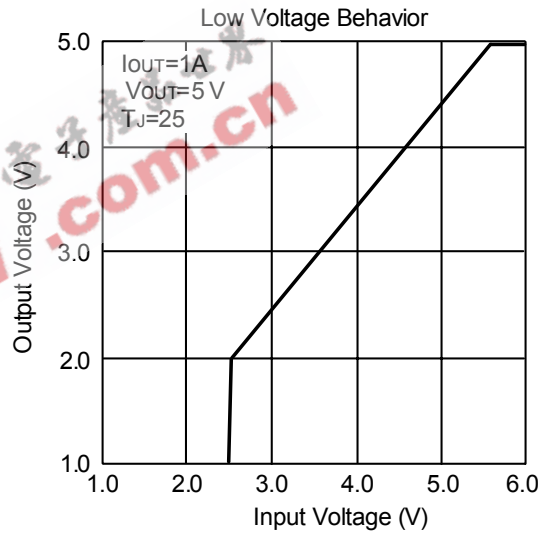
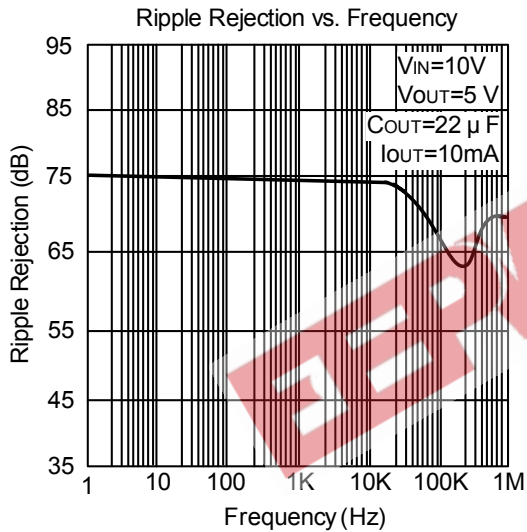
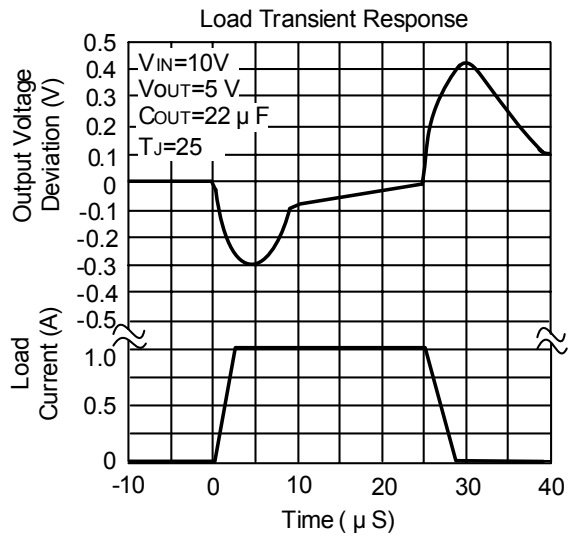
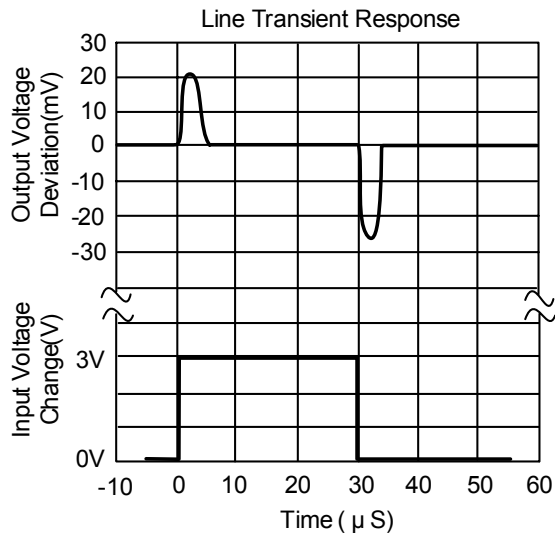



## TYPICAL CHARACTERISTICS (Cont.)

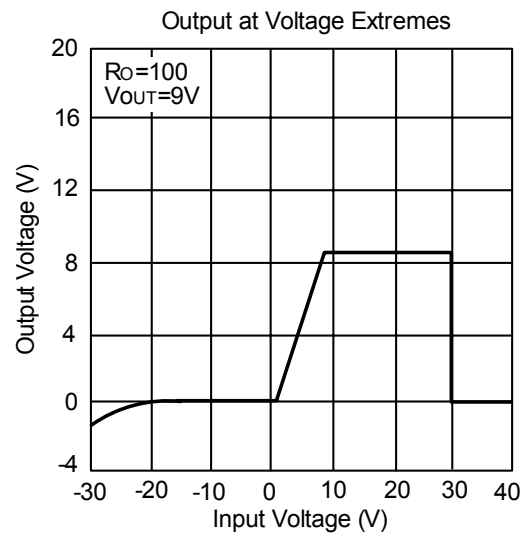
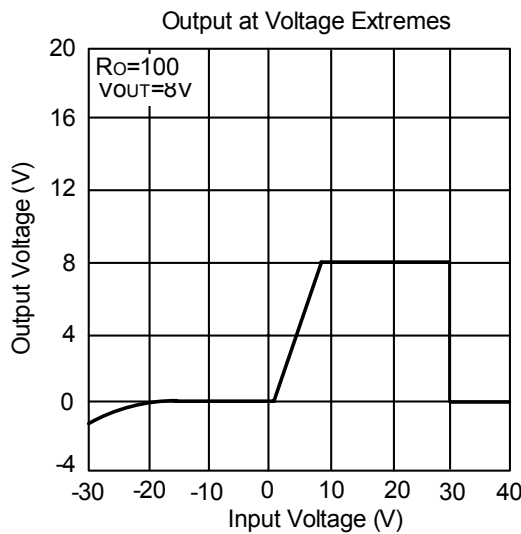
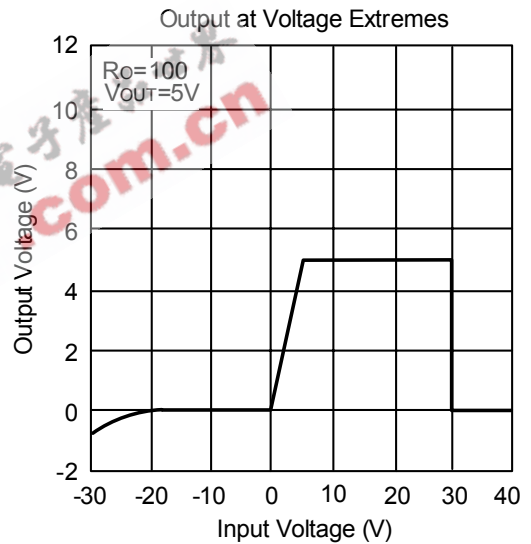
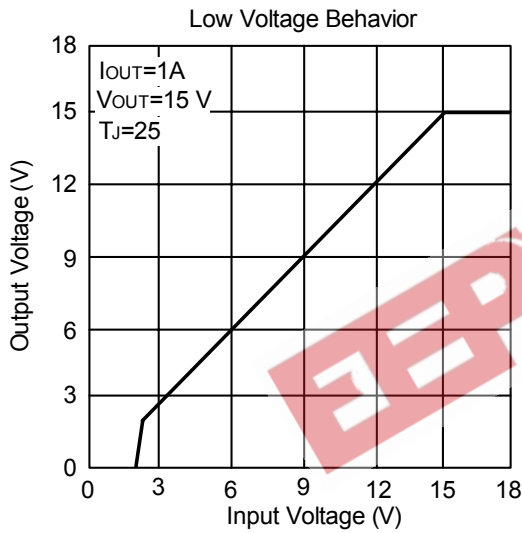
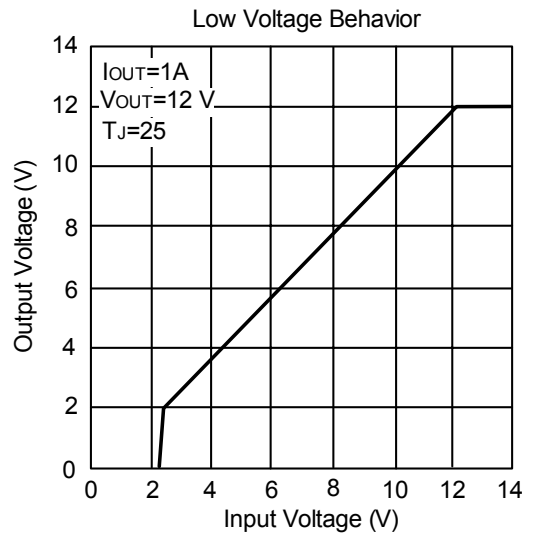
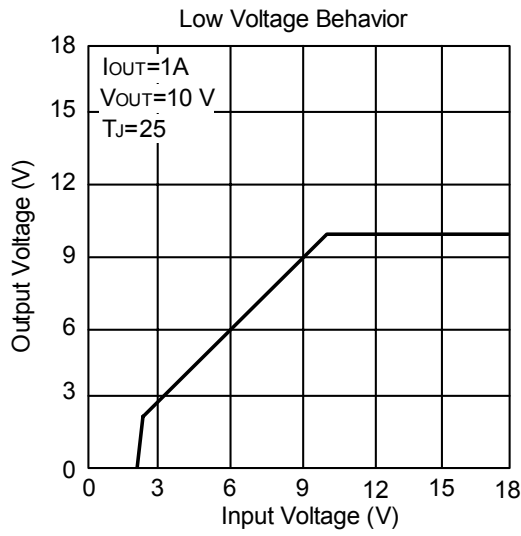

### TYPICAL CHARACTERISTICS (Cont.)

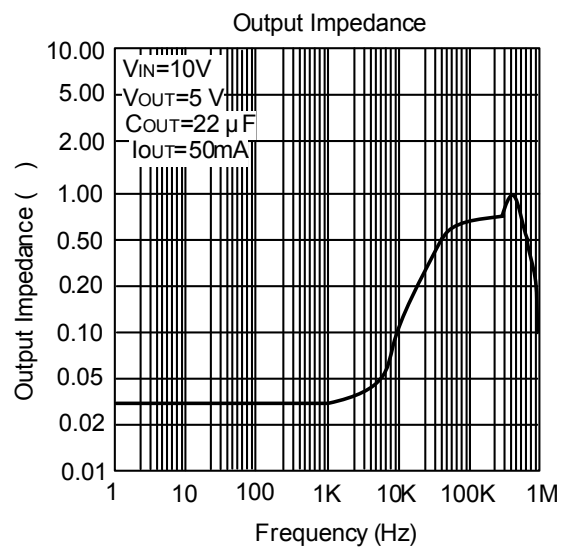
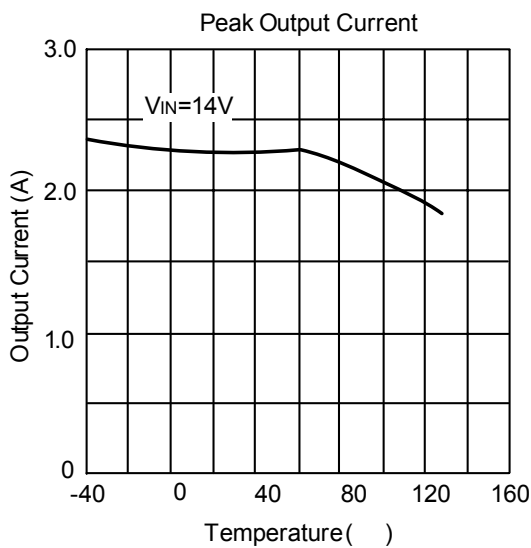
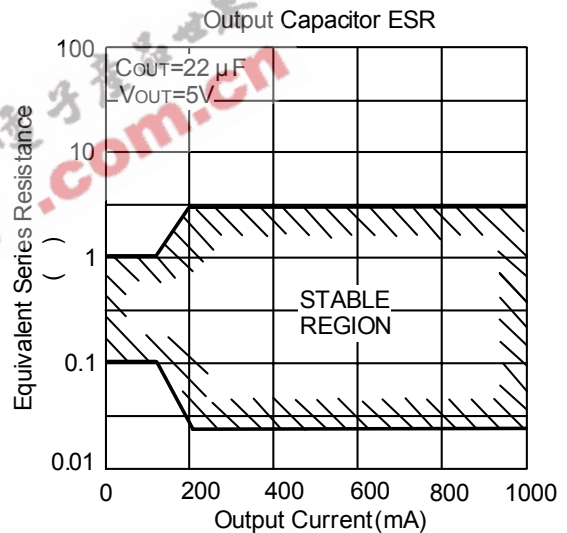
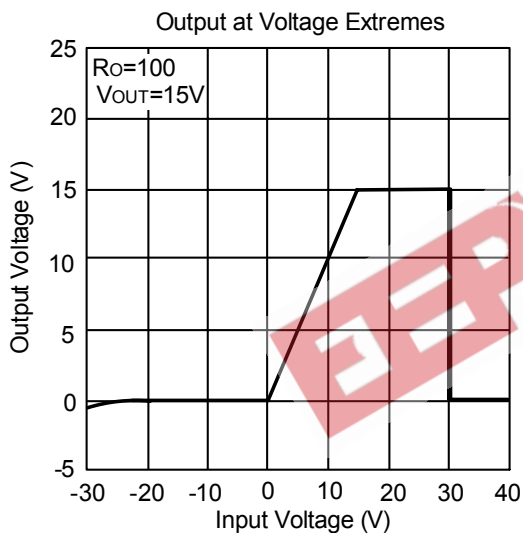
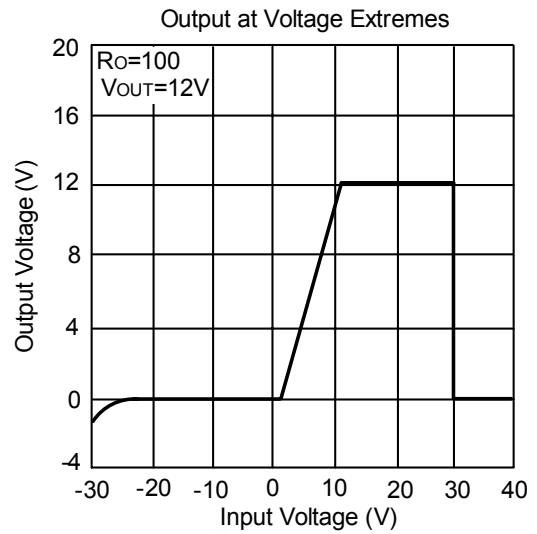
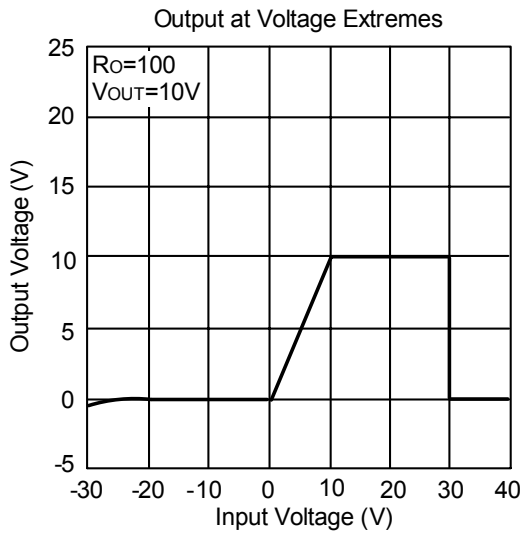

■ TYPICAL CHARACTERISTICS (Cont.)

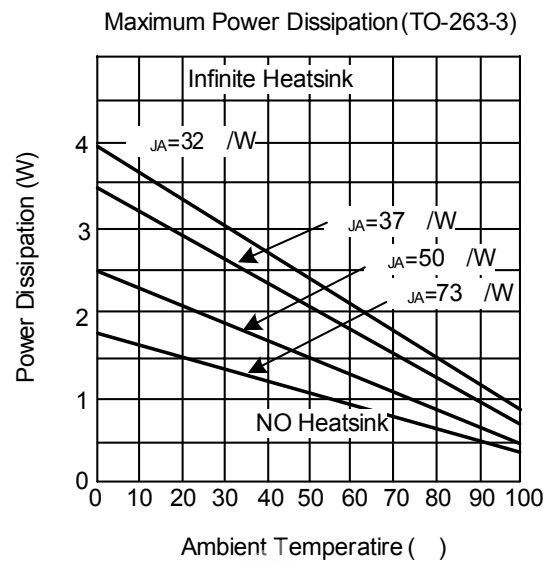
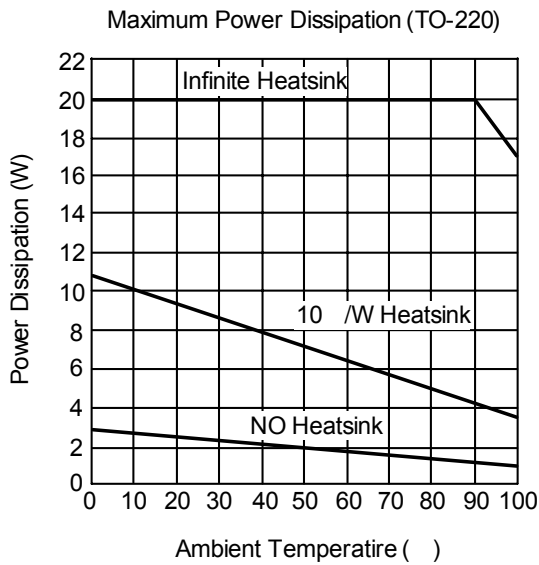

UTC assumes no responsibility for equipment failures that result from using products at values that exceed, even momentarily, rated values (such as maximum ratings, operating condition ranges, or other parameters) listed in products specifications of any and all UTC products described or contained herein. UTC products are not designed for use in life support appliances, devices or systems where malfunction of these products can be reasonably expected to result in personal injury. Reproduction in whole or in part is prohibited without the prior written consent of the copyright owner. The information presented in this document does not form part of any quotation or contract, is believed to be accurate and reliable and may be changed without notice.