

LM4868 Boomer® Audio Power Amplifier Series

Output-Transient-Free Dual 2.1W Audio Amplifier Plus No Coupling Capacitor Stereo Headphone Function

General Description

The LM4868 is a dual bridge-connected audio power amplifier which, when connected to a 5V supply, will deliver 2.1W to a 4Ω load (Note 1) or 2.4W to a 3Ω load (Note 2) with less than 1.0% THD+N. The LM4868 uses advanced, latest generation circuitry to eliminate all traces of clicks and pops when the supply voltage is first applied. The amplifier has a headphone-amplifier-select input pin. It is used to switch the amplifiers from bridge to single-ended mode for driving headphones. A new circuit topology eliminates headphone output coupling capacitors (patent pending). A MUX control pin allows selection between the two sets of stereo input signals. The MUX control can also be used to select between two different customer-specified closed-loop responses.

Boomer audio power amplifiers are designed specifically to provide high quality output power from a surface mount package and require few external components. To simplify audio system design, the LM4868 combines dual bridge speaker amplifiers and stereo headphone amplifiers in one package.

The LM4868 features an externally controlled power-saving micropower shutdown mode, a stereo headphone amplifier mode, and thermal shutdown protection.

Note 1: An LM4868LQ or LM4868MTE that has been properly mounted to a circuit board will deliver 2.1W into 4Ω. The Mux control can also be used to select two different closed-loop responses. LM4868MT will deliver 1.1W into 8Ω. See the Application Information sections for further information concerning the LM4868LQ and the LM4868MT.

Note 2: An LM4868LQ or LM4868MTE that has been properly mounted to a circuit board and forced-air cooled will deliver 2.4W into 3Ω.

Key Specifications

- P_O at 1% THD+N
 - LM4868LQ, 3Ω load 2.4W (typ)
 - LM4868LQ, 4Ω load 2.1W (typ)
 - LM4868MTE, 4Ω 1.9W (typ)
 - LM4868MT, 8Ω 1.1W (typ)
- Single-ended mode - THD+N at 75mW into 32Ω 0.5% (max)
- Shutdown current 0.7μA (typ)

Features

- Advanced "click and pop" suppression circuitry
- Eliminates headphone amplifier output coupling capacitors (patent pending)
- Stereo headphone amplifier mode
- Input mux control and two separate inputs per channel
- Thermal shutdown protection circuitry
- LLP, TSSOP, and exposed-DAP TSSOP packaging available

Applications

- Multimedia monitors
- Portable and desktop computers
- Portable audio systems

Connection Diagrams

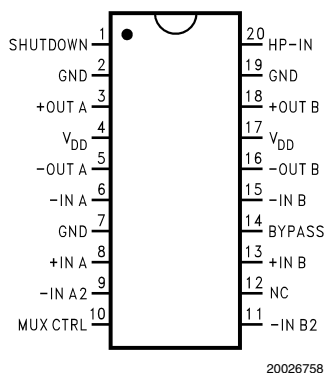

Top View

Order Number LM4868MT, LM4868MTE

See NS Package Number MTC20 for TSSOP

See NS Package Number MXA20A for Exposed-DAP TSSOP

Connection Diagrams (Continued)

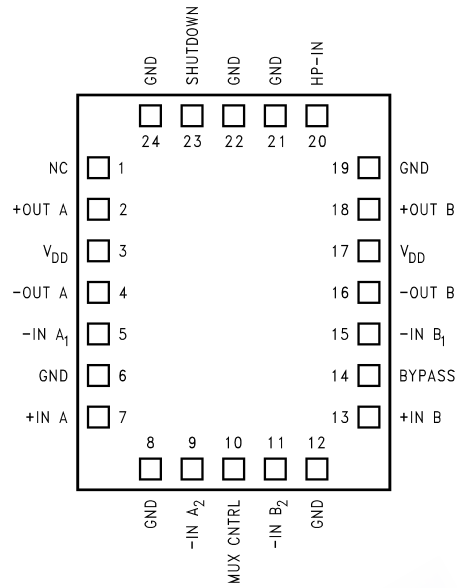

Top View

Order Number LM4868LQ

See NS Package Number LQA24A for Exposed-DAP LLP

Typical Application

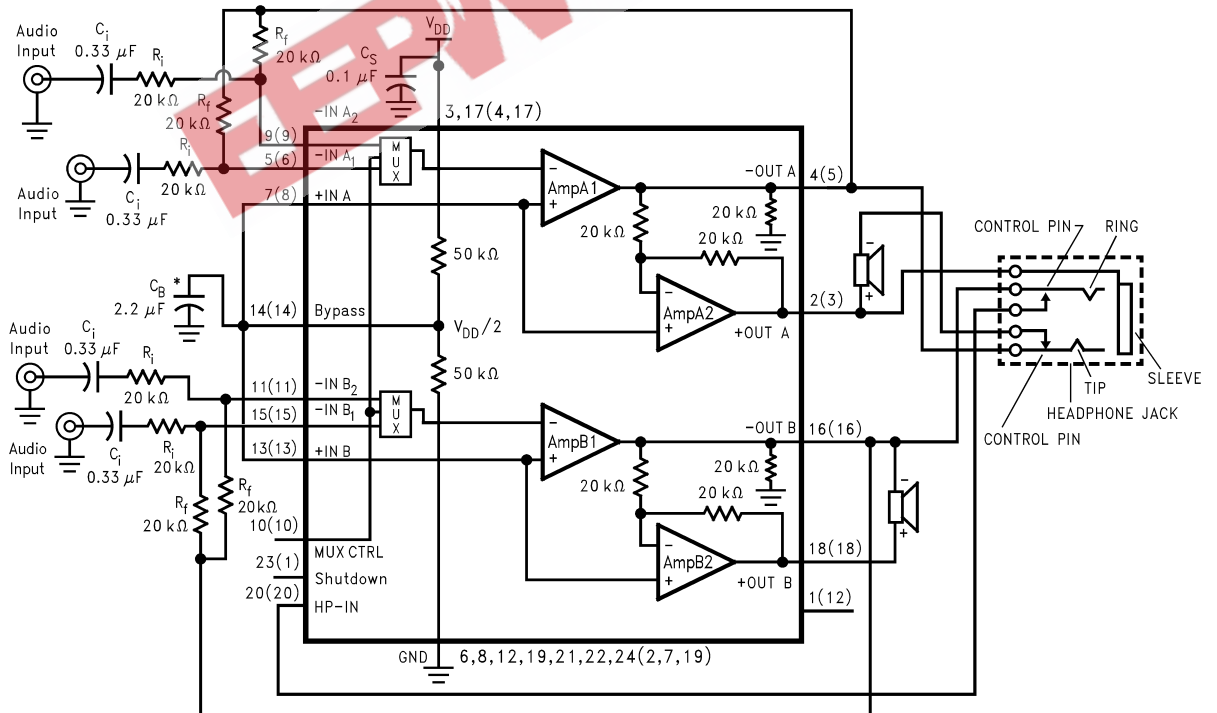

* Refer to the Application Information section titled PROPER SELECTION OF EXTERNAL COMPONENTS for details concerning the value of C_B .

FIGURE 1. Typical Audio Amplifier Application Circuit (Pin out shown for the 24-pin Exposed-DAP LLP package. Numbers in () are for the 20-pin MTE and MT packages.)

Absolute Maximum Ratings (Note 3)

If Military/Aerospace specified devices are required, please contact the National Semiconductor Sales Office/Distributors for availability and specifications.

Supply Voltage	6.0V
Storage Temperature	-65°C to +150°C
Input Voltage	-0.3V to V_{DD} +0.3V
Power Dissipation (Note 4)	Internally limited
ESD Susceptibility (Note 5)	
All pins except Pin 3 (MT, MTE), Pin 2 (LQ)	2000V
Pin 3 (MT, MTE), Pin 2 (LQ)	8000V
ESD Susceptibility (Note 6)	200V
Junction Temperature	150°C
Solder Information	
Small Outline Package	
Vapor Phase (60 sec.)	215°C
Infrared (15 sec.)	220°C

See AN-450 "Surface Mounting and their Effects on Product Reliability" for other methods of soldering surface mount devices.

Thermal Resistance

θ_{JC} (typ) — MTC20	20°C/W
θ_{JA} (typ) — MTC20	80°C/W
θ_{JC} (typ) — MXA20A	2°C/W
θ_{JA} (typ) — MXA20A	41°C/W (Note 7)
θ_{JA} (typ) — MXA20A	51°C/W (Note 8)
θ_{JA} (typ) — MXA20A	90°C/W (Note 9)
θ_{JC} (typ) — LQA24A	3.0°C/W
θ_{JA} (typ) — LQA24A	42°C/W (Note 10)

Operating Ratings

Temperature Range

$$T_{MIN} \leq T_A \leq T_{MAX} \quad -40^\circ\text{C} \leq T_A \leq 85^\circ\text{C}$$

Supply Voltage

$$2.0\text{V} \leq V_{DD} \leq 5.5\text{V}$$

Electrical Characteristics for Entire IC (Notes 3, 11)

The following specifications apply for $V_{DD} = 5\text{V}$ unless otherwise noted. Limits apply for $T_A = 25^\circ\text{C}$.

Symbol	Parameter	Conditions	LM4868		Units (Limits)
			Typical (Note 12)	Limit (Note 13)	
V_{DD}	Supply Voltage			2	V (min)
				5.5	V (max)
I_{DD}	Quiescent Power Supply Current	$V_{IN} = 0\text{V}$, $I_O = 0\text{A}$ (Note 14), HP-IN = 0V	7.5	15	mA (max)
		$V_{IN} = 0\text{V}$, $I_O = 0\text{A}$ (Note 14), HP-IN = 4V	3.0	6	mA (max)
I_{SD}	Shutdown Current	V_{DD} applied to the SHUTDOWN pin	0.7	2	μA (max)
TH_{um}	Un-Mute Threshold Voltage	GND applied to SHUTDOWN pin	25	10	mV (min)
		V_{IN} applied to selected MUX channel		40	mV (max)

Electrical Characteristics for Bridged-Mode Operation (Notes 3, 11)

The following specifications apply for $V_{DD} = 5\text{V}$ unless otherwise specified. Limits apply for $T_A = 25^\circ\text{C}$.

Symbol	Parameter	Conditions	LM4868		Units (Limits)
			Typical (Note 12)	Limit (Note 13)	
V_{OS}	Output Offset Voltage	$V_{IN} = 0\text{V}$	5	50	mV (max)
P_O	Output Power (Note 15)	THD = 1%, $f = 1\text{kHz}$ (Note 16)			
		LM4868MTE, $R_L = 3\Omega$	2.2		W
		LM4868LQ, $R_L = 3\Omega$	2.4		W
		LM4868MTE, $R_L = 4\Omega$	1.9		W
		LM4868LQ, $R_L = 4\Omega$	2.1		W
		LM4868, $R_L = 8\Omega$	1.1	1.0	W (min)
		THD+N = 10%, $f = 1\text{kHz}$ (Note 16)			
	LM4868MTE, $R_L = 3\Omega$	3.0		W	
	LM4868LQ, $R_L = 3\Omega$	3.0		W	
	LM4868MTE, $R_L = 4\Omega$	2.6		W	
	LM4868LQ, $R_L = 4\Omega$	2.6		W	
	LM4868, $R_L = 8\Omega$	1.5		W	
	THD+N = 1%, $f = 1\text{kHz}$, $R_L = 32\Omega$	0.34		W	

Electrical Characteristics for Bridged-Mode Operation (Notes 3, 11) (Continued)

The following specifications apply for $V_{DD} = 5V$ unless otherwise specified. Limits apply for $T_A = 25^\circ C$.

Symbol	Parameter	Conditions	LM4868		Units (Limits)
			Typical (Note 12)	Limit (Note 13)	
THD+N	Total Harmonic Distortion+Noise	$20\text{Hz} \leq f \leq 20\text{kHz}$, $A_{VD} = 2$			
		LM4868MTE, $R_L = 4\Omega$, $P_O = 2W$	0.3		%
		LM4868LQ, $R_L = 4\Omega$, $P_O = 2W$	0.3		%
		LM4868, $R_L = 8\Omega$, $P_O = 1W$	0.3		%
PSRR	Power Supply Rejection Ratio	$V_{DD} = 5V$, $V_{RIPPLE} = 200\text{ mV}_{RMS}$, $R_L = 8\Omega$, $C_B = 2.2\mu F$	67		dB
X_{TALK}	Channel Separation	$f = 1\text{ kHz}$, $C_B = 2.2\mu F$	80		dB
SNR	Signal To Noise Ratio	$V_{DD} = 5V$, $P_O = 1.1W$, $R_L = 8\Omega$	97		dB

Electrical Characteristics for Single-Ended Operation (Notes 3, 11)

The following specifications apply for $V_{DD} = 5V$ unless otherwise specified. Limits apply for $T_A = 25^\circ C$.

Symbol	Parameter	Conditions	LM4868		Units (Limits)
			Typical (Note 12)	Limit (Note 13)	
V_{OS}	Output Offset Voltage	$V_{IN} = 0V$	5	50	mV (max)
P_O	Output Power	THD = 0.5%, $f = 1\text{kHz}$, $R_L = 32\Omega$	85	75	mW (min)
		THD+N = 1%, $f = 1\text{kHz}$, $R_L = 8\Omega$ (Note 17)	180		mW
		THD+N = 1%, $f = 1\text{kHz}$, $R_L = 16\Omega$	165		mW
		THD+N = 1%, $f = 1\text{kHz}$, $R_L = 32\Omega$	88		mW
		THD+N = 10%, $f = 1\text{kHz}$, $R_L = 16\Omega$	208		mW
		THD+N = 10%, $f = 1\text{kHz}$, $R_L = 32\Omega$	114		mW
V_{OUT}	Output Voltage Swing	THD = 0.05%, $R_L = 5k\Omega$	1		V_{P-P}
THD+N	Total Harmonic Distortion+Noise	$A_V = -1$, $P_O = 75\text{mW}$, $20\text{ Hz} \leq f \leq 20\text{kHz}$, $R_L = 32\Omega$	0.2		%
PSRR	Power Supply Rejection Ratio	$C_B = 2.2\mu F$, $V_{RIPPLE} = 200\text{mV}_{RMS}$, $f = 1\text{kHz}$	52		dB
X_{TALK}	Channel Separation	$f = 1\text{kHz}$, $C_B = 2.2\mu F$	60		dB
SNR	Signal To Noise Ratio	$V_{DD} = 5V$, $P_O = 340\text{mW}$, $R_L = 8\Omega$	94		dB

Note 3: Absolute Maximum Ratings indicate limits beyond which damage to the device may occur. Operating Ratings indicate conditions for which the device is functional, but do not guarantee specific performance limits. Electrical Characteristics state DC and AC electrical specifications under particular test conditions which guarantee specific performance limits. This assumes that the device operates within the Operating Ratings. Specifications are not guaranteed for parameters where no limit is given. The typical value however, is a good indication of device performance.

Note 4: The maximum power dissipation must be derated at elevated temperatures and is dictated by T_{JMAX} , θ_{JA} , and the ambient temperature T_A . The maximum allowable power dissipation is $P_{DMAX} = (T_{JMAX} - T_A)/\theta_{JA}$. For the LM4868, $T_{JMAX} = 150^\circ C$. For the θ_{JA} s for different packages, please see the Application Information section or the Absolute Maximum Ratings section.

Note 5: Human body model, 100pF discharged through a 1.5k Ω resistor.

Note 6: Machine model, 220pF–240pF discharged through all pins.

Note 7: The given θ_{JA} is for an LM4868 packaged in an MXA20A with the Exposed-DAP soldered to an exposed 2in² area of 1oz printed circuit board copper.

Note 8: The given θ_{JA} is for an LM4868 packaged in an MXA20A with the Exposed-DAP soldered to an exposed 1in² area of 1oz printed circuit board copper.

Note 9: The given θ_{JA} is for an LM4868 packaged in an MXA20A with the Exposed-DAP not soldered to printed circuit board copper.

Note 10: The given θ_{JA} is for an LM4868 packaged in an LQA24A with the Exposed-DAP soldered to an exposed 2in² area of 1oz printed circuit board copper.

Note 11: All voltages are measured with respect to the ground (GND) pins, unless otherwise specified.

Note 12: Typicals are measured at 25°C and represent the parametric norm.

Note 13: Limits are guaranteed to National's AOQL (Average Outgoing Quality Level). Datasheet min/max specification limits are guaranteed by design, test, or statistical analysis.

Note 14: The quiescent power supply current depends on the offset voltage when a practical load is connected to the amplifier.

Note 15: Output power is measured at the device terminals.

Note 16: When driving 3 Ω or 4 Ω loads and operating on a 5V supply, the LM4868LQ and LM4868MTE must be mounted to a circuit board that has a minimum of 2.5in² of exposed, uninterrupted copper area connected to the LLP or TSSOP package's exposed DAP.

Note 17: See Application Information section 'Single-Ended Output Power Performance and Measurement Considerations' for more information.

Typical Performance Characteristics MTE- and LQ- Specific Characteristics

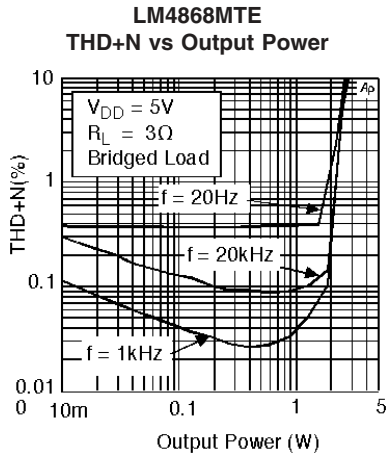

20026733

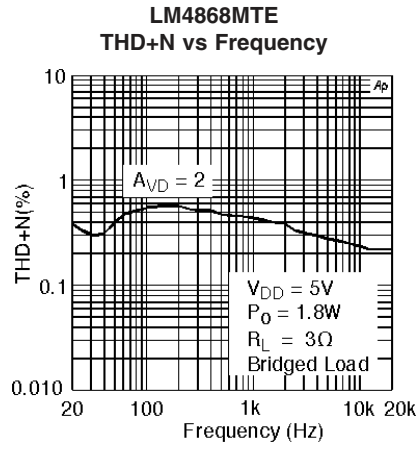

20026734

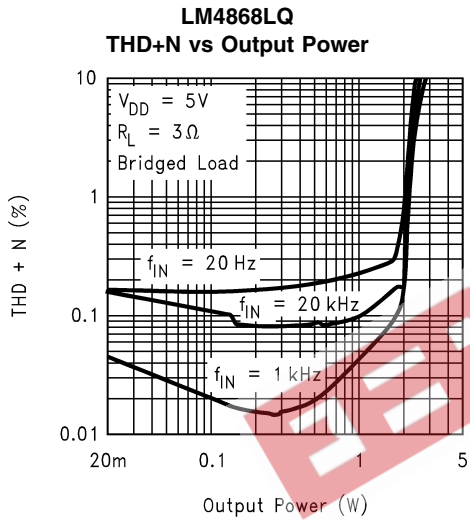

20026753

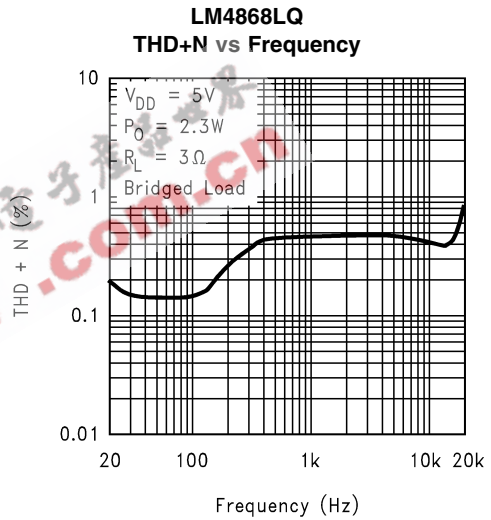

20026754

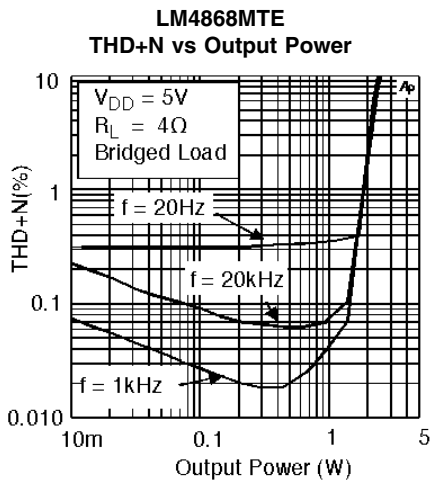

20026736

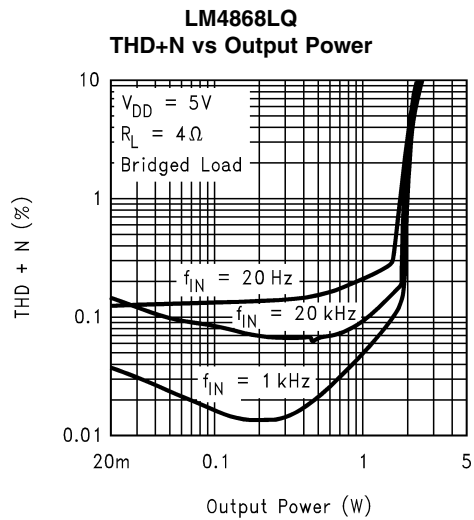

20026755

Typical Performance Characteristics MTE- and LQ- Specific Characteristics (Continued)

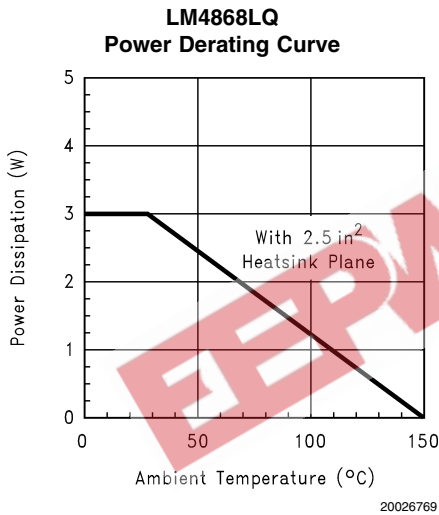
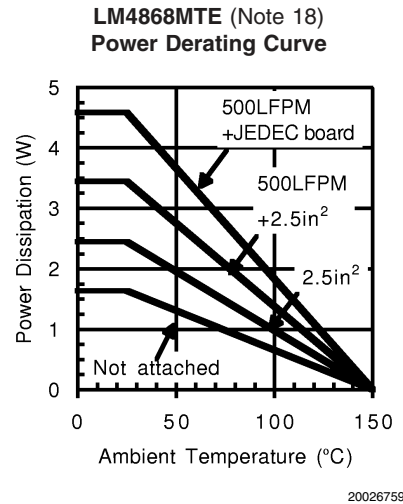
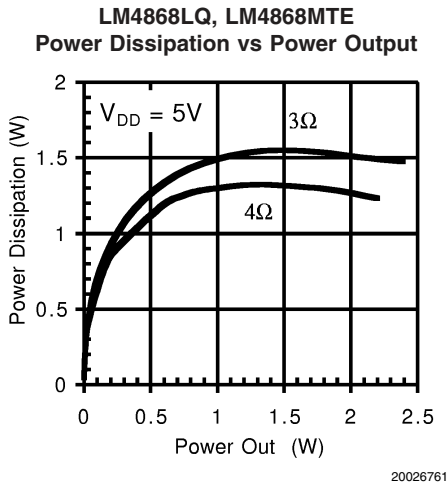

Note 18: This curve shows the LM4868MTE's thermal dissipation ability at different ambient temperatures given these conditions:

500LFPM + JEDEC board: The part is soldered to a 1S2P 20-lead exposed-DAP TSSOP test board with 500 linear feet per minute of forced-air flow across it. **Board information** - copper dimensions: 74x74mm, copper coverage: 100% (buried layer) and 12% (top/bottom layers), 16 vias under the exposed-DAP.

500LFPM + 2.5in²: The part is soldered to a 2.5in², 1 oz. copper plane with 500 linear feet per minute of forced-air flow across it.

2.5in²: The part is soldered to a 2.5in², 1oz. copper plane.

Not Attached: The part is not soldered down and is not forced-air cooled.

Typical Performance Characteristics

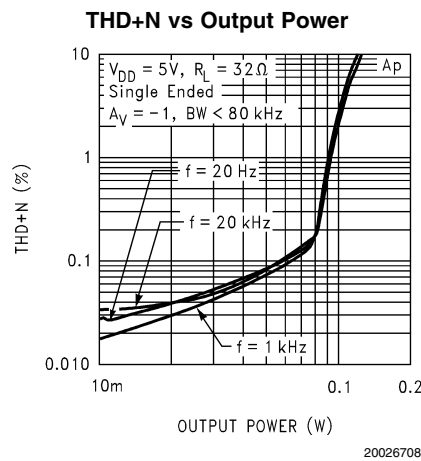
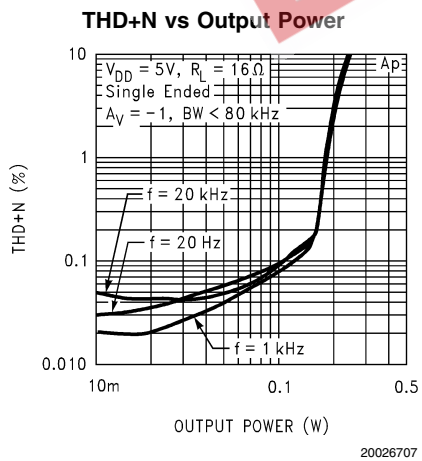
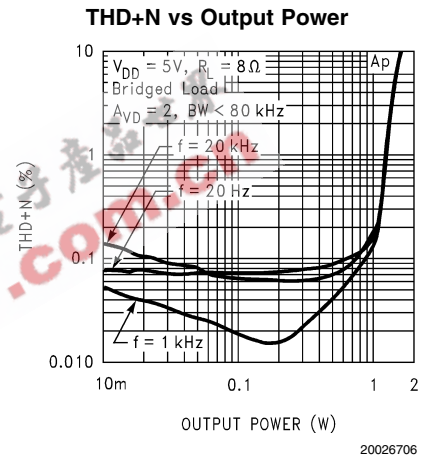
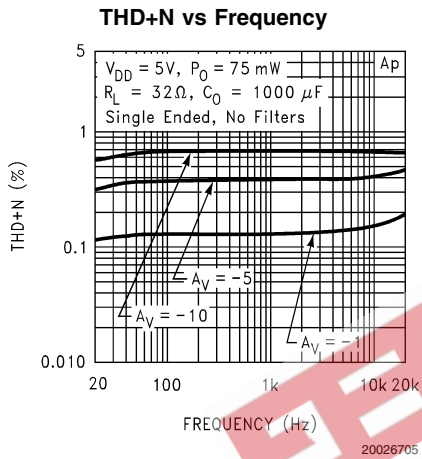
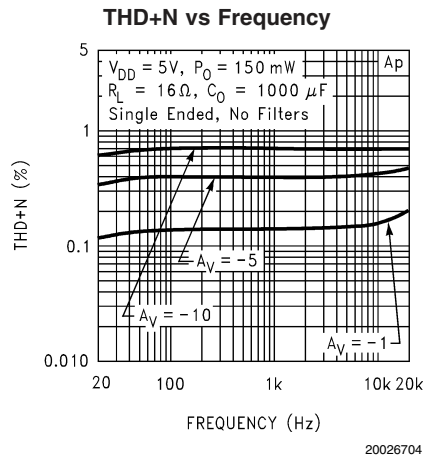
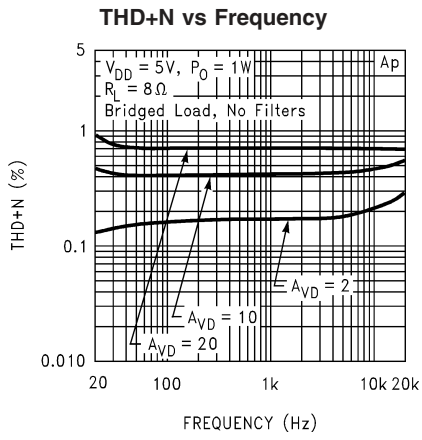

Typical Performance Characteristics (Continued)

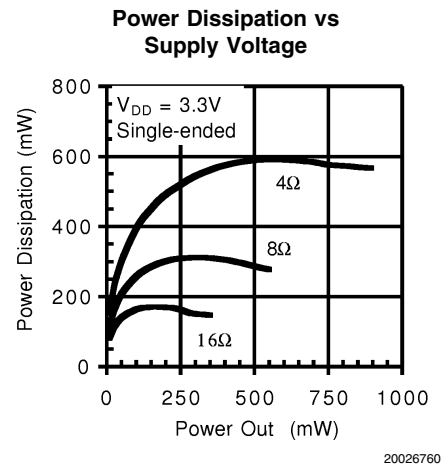
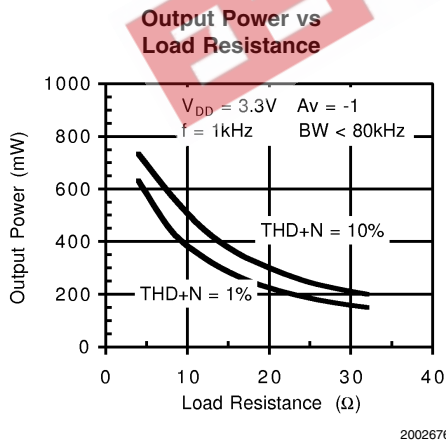
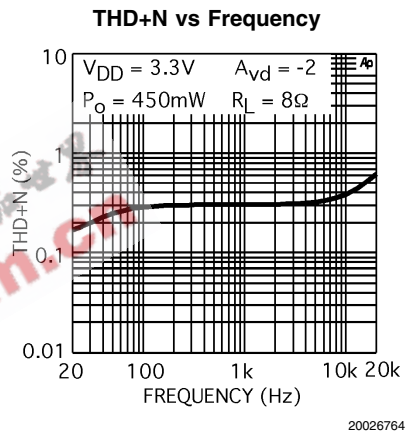
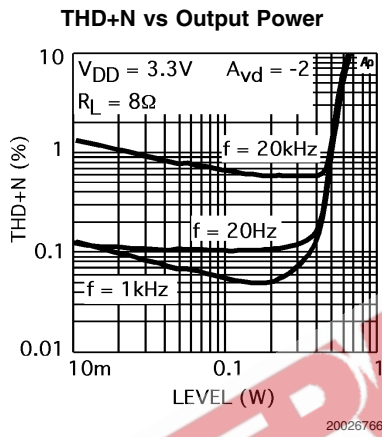
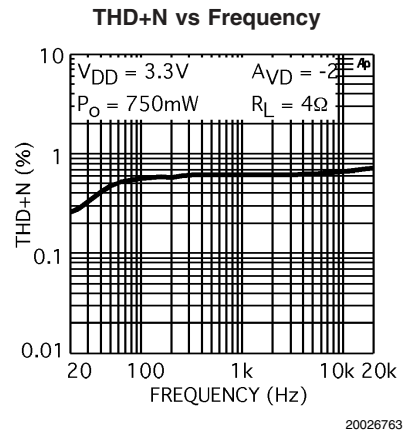
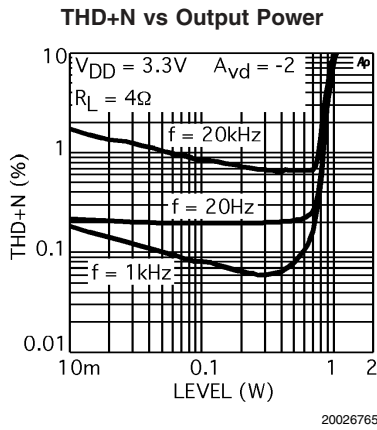

Typical Performance Characteristics (Continued)

Output Power vs Supply Voltage

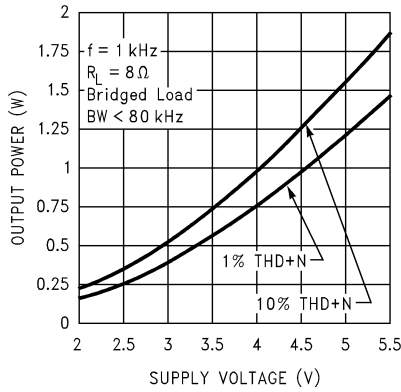

Output Power vs Supply Voltage

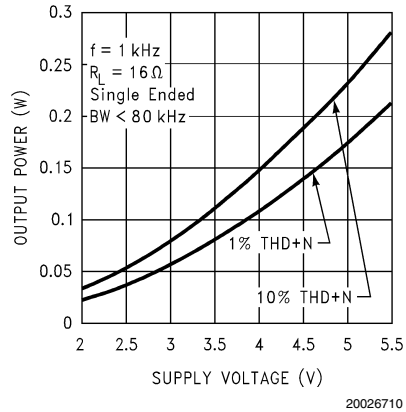

Output Power vs Supply Voltage

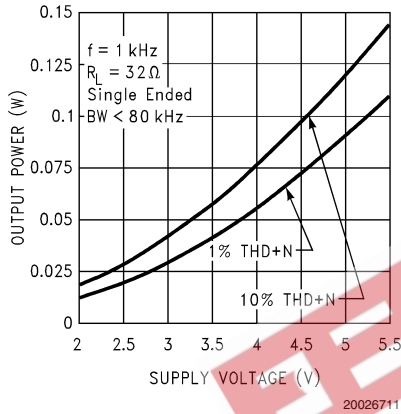

Output Power vs Load Resistance

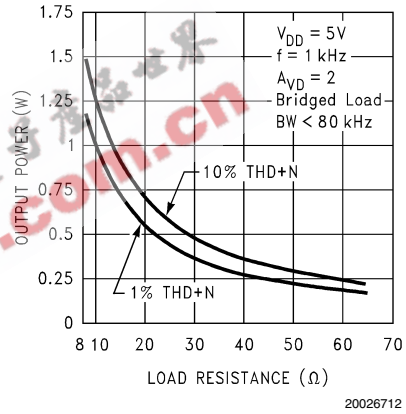

Output Power vs Load Resistance

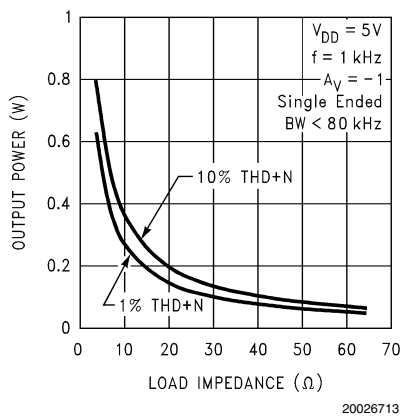

Power Dissipation vs Output Power

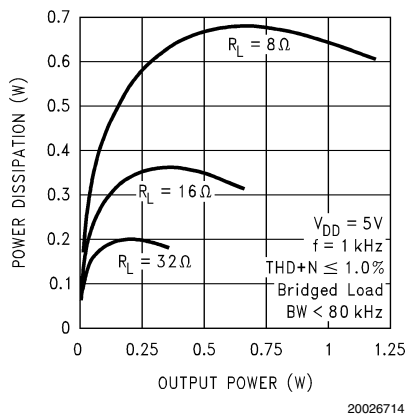

Typical Performance Characteristics (Continued)

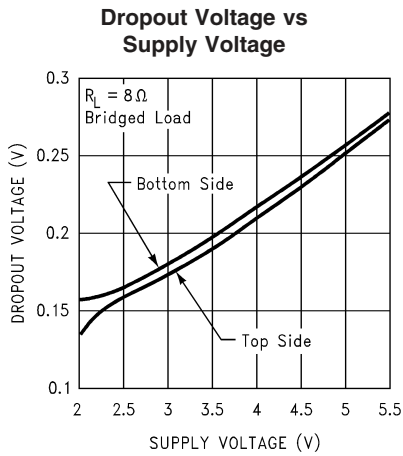

20026715

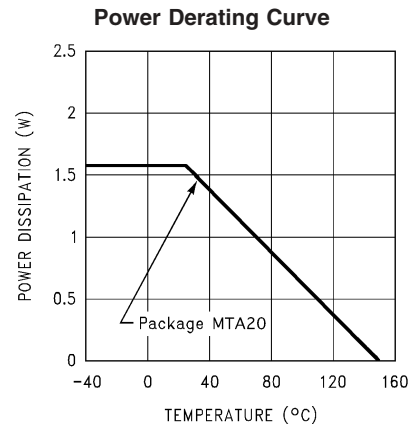

20026716

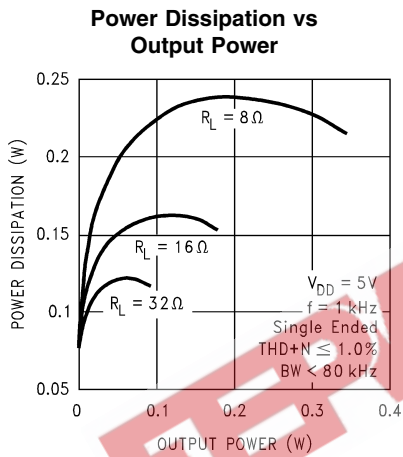

20026717

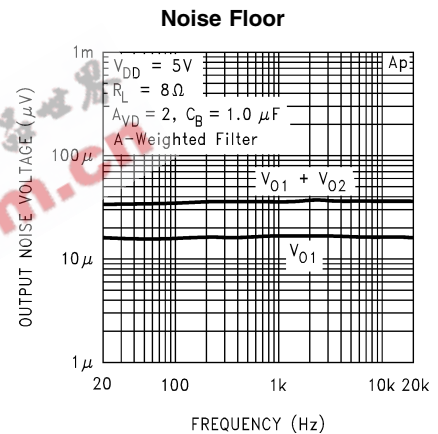

20026718

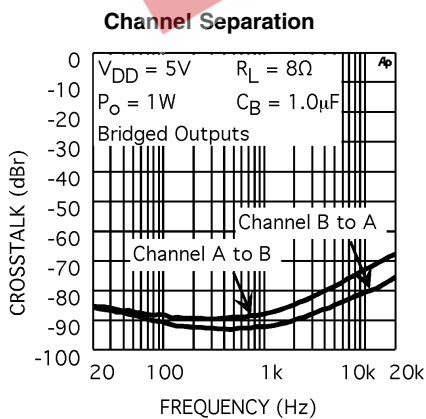

20026719

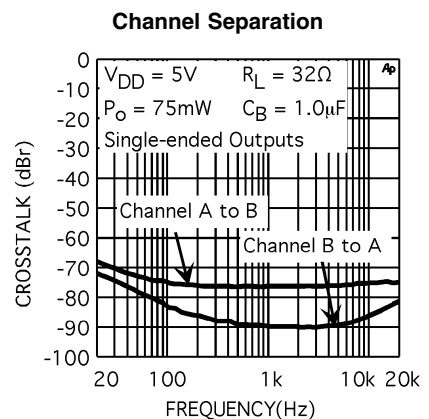

20026720

Typical Performance Characteristics (Continued)

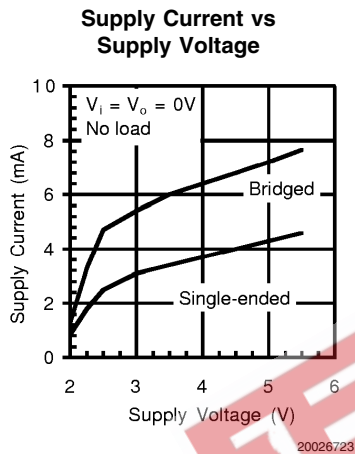
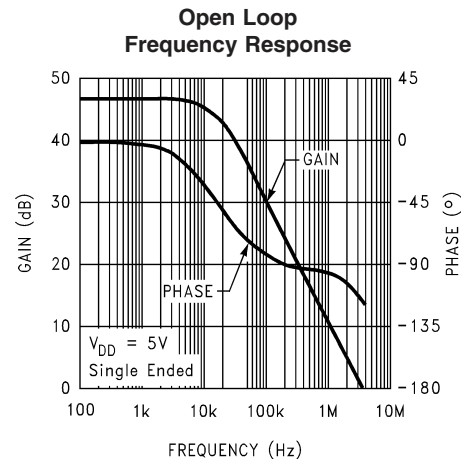
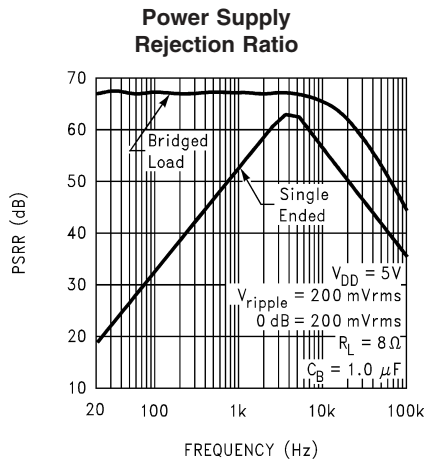

External Components Description

(Refer to Figure 1.)

Components	Functional Description
1. R_i	This is the inverting input resistance that sets the closed-loop gain in conjunction with R_f . This resistor also forms a high pass filter with C_i at $f_c = 1/(2\pi R_i C_i)$.
2. C_i	This is the input coupling capacitor. It blocks the DC voltage at the amplifier's input terminals. It also creates a highpass filter with R_i at $f_c = 1/(2\pi R_i C_i)$. Refer to the section, Selecting External Components , for an explanation of how to determine the value of C_i .
3. R_f	This is the feedback resistance. It sets the closed-loop gain in conjunction with R_i .
4. C_s	This is the supply bypass capacitor. It provides power supply filtering. Refer to the Power Supply Bypassing section for information concerning proper placement and selection of the supply bypass capacitor.
5. C_B	This is the bypass pin capacitor. It provides half-supply filtering. Refer to the section, Proper Selection of External Components , for information concerning proper placement and selection of C_B .

Application Information

ELIMINATING OUTPUT COUPLING CAPACITORS

Typical single-supply audio amplifiers that can switch between driving bridge-tied-load (BTL) speakers and single-ended (SE) headphones use a coupling capacitor on each SE output. This capacitor blocks the half-supply voltage to which the output amplifiers are typically biased and

couples the audio signal to the headphones. The signal return to circuit ground is through the headphone jack's sleeve.

The LM4868 eliminates these coupling capacitors. Amp2A is internally configured to apply $V_{DD}/2$ to a stereo headphone jack's sleeve. This voltage matches the quiescent voltage present on the Amp1A and Amp1B outputs that drive the

Application Information (Continued)

headphones. The headphones operate in a manner very similar to a bridge-tied-load (BTL). The same DC voltage is applied to both headphone speaker terminals. This results in no net DC current flow through the speaker. AC current flows through a headphone speaker as an audio signal's output amplitude increases on the speaker's terminal.

When operating as a headphone amplifier, the headphone jack sleeve is not connected to circuit ground. Using the headphone output jack as a line-level output will place the LM4868's one-half supply voltage on a plug's sleeve connection. Driving a portable notebook computer or audio-visual display equipment is possible. This presents no difficulty when the external equipment uses capacitively coupled inputs. For the very small minority of equipment that is DC-coupled, the LM4868 monitors the current supplied by the amplifier that drives the headphone jack's sleeve. If this current exceeds 500mA_{PK} , the amplifier is shutdown, protecting the LM4868 and the external equipment. For more information, see the section titled 'Single-Ended Output Power Performance and Measurement Considerations'.

OUTPUT TRANSIENT ('POPS AND CLICKS') ELIMINATED

The LM4868 contains advanced circuitry that eliminates output transients ('pop and click'). This circuitry prevents all traces of transients when the supply voltage is first applied, when the part resumes operation after shutdown, or when switching between BTL speakers and SE headphones. Two circuits combine to eliminate pop and click. One circuit mutes the output when switching between speaker loads. Another circuit monitors the input signal. It maintains the muted condition until there is sufficient input signal magnitude ($>25\text{mV}_{\text{RMS}}$, typ) to mask any remaining transient that may occur.

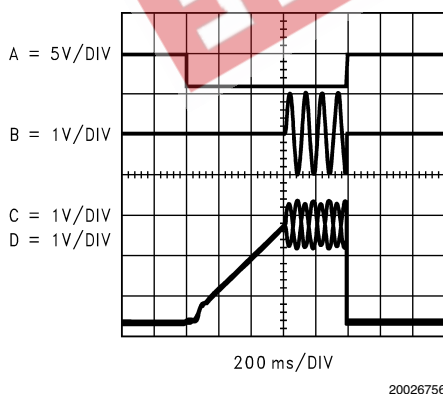

FIGURE 2. Differential output signal (Trace B) is devoid of transients. The SHUTDOWN pin is driven by a shutdown signal (Trace A). The inverting output (Trace C) and the non-inverting output (Trace D) are applied across an 8Ω BTL load.

Figure 2 shows the LM4868's lack of transients in the differential signal (Trace B) across a BTL 8Ω load. The LM4868's active-high SHUTDOWN pin is driven by the logic signal

shown in Trace A. Trace C is the VOUT- output signal and trace D is the VOUT+ output signal. The shutdown signal frequency is 1Hz with a 50% duty cycle. Figure 3 is generated with the same conditions except that the output drives a 32Ω single-ended (SE) load. Again, no trace of output transients is seen.

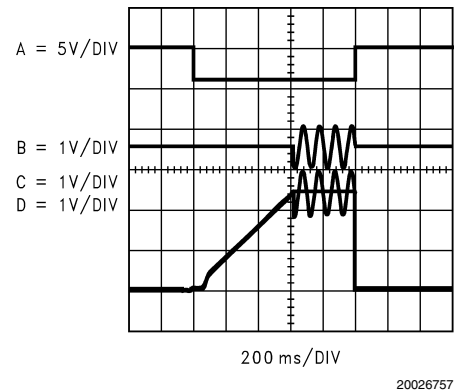

FIGURE 3. Single-ended output signal (Trace B) is devoid of transients. The SHUTDOWN pin is driven by a shutdown signal (Trace A). The inverting output (Trace C) and the V_{BYPASS} output (Trace D) are applied across a 32Ω BTL load.

USING THE LM4868 TO UPGRADE LM4863 AND LM4873 DESIGNS

The LM4868's noise-free operation plus coupling-capacitorless headphone operation and functional compatibility with the LM4873 and the LM4863 simplifies upgrading systems using these parts. Upgrading older designs that use either the LM4863 or the LM4873 is easy. Simply remove and short the coupling capacitors located between the LM4873's or LM4863's Amp1A and Amp1B outputs and the headphone connections. Also remove the $1\text{k}\Omega$ resistor between each headphone connection and ground. Finally, remove any resistors connected to the HP-IN pin (typically two $100\text{k}\Omega$ resistors). Connect the HP-IN pin directly to the headphone jack control pin as shown in Figure 4.

The LM4868's pin configuration simplifies the process of upgrading systems that use the LM4863. Except for its four MUX function pins, the LM4868's pin configuration matches the LM4863's pin configuration. If the LM4868's MUX functionality is not needed when replacing an LM4863, connect the MUX CTRL pin to either V_{DD} or ground. To ensure correct amplifier operation, unused MUX inputs should be tied to GND. As shown in Table 1, grounding the MUX CTRL pin selects stereo input 1 ($-\text{IN A1}$ and $-\text{IN B1}$), whereas applying V_{DD} to the MUX CTRL pin selects stereo input 2 ($-\text{IN A2}$ and $-\text{IN B2}$).

The LM4868's unique headphone sense circuit requires a dual switch headphone jack. Replace the four-terminal headphone jack used with the LM4863 and LM4873 with the five-terminal headphone jack, such as the Switchcraft 35RAPC4BH3, shown in Figure 4. Connect the +OUT A (Amp2A) pin to the five-terminal headphone jack's sleeve pin.

Application Information (Continued)

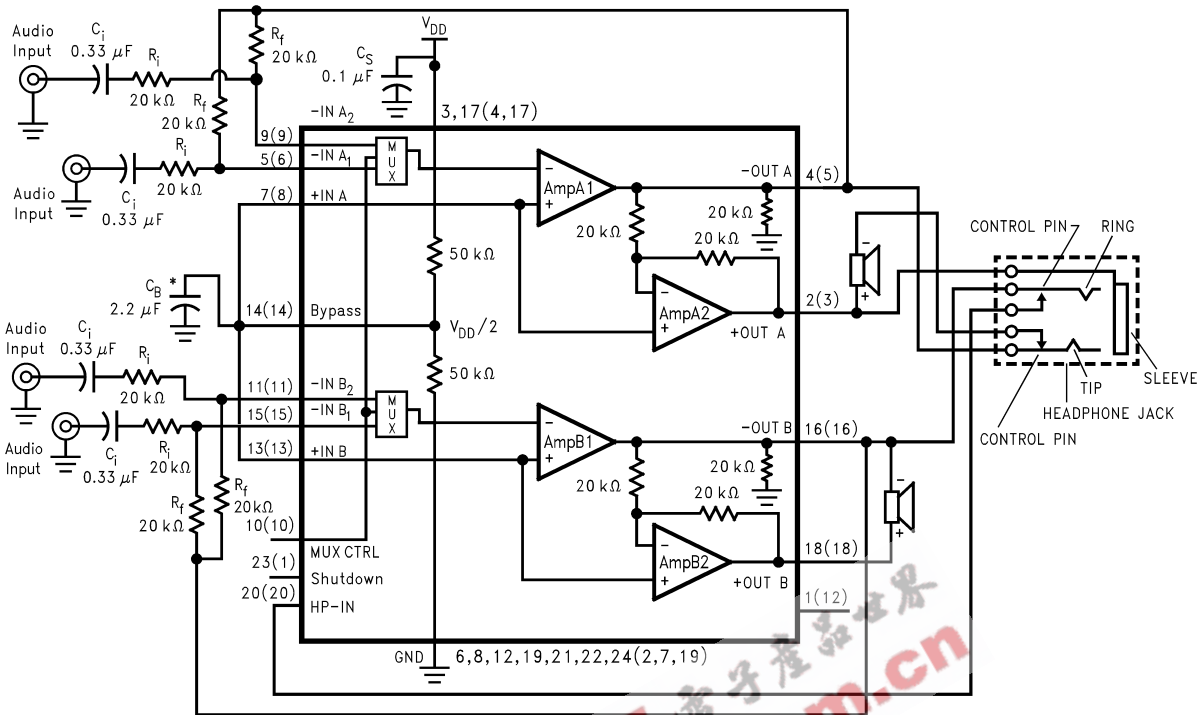

20026731

FIGURE 4. Typical Audio Amplifier Application Circuit (Pin out shown for the 24-pin Exposed-DAP LLP package. Numbers in () are for the 20-pin MTE and MT packages.)

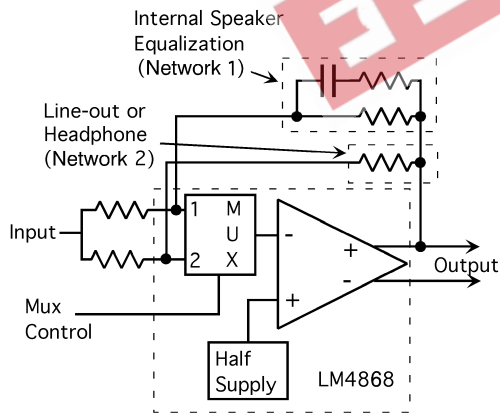

20026728

FIGURE 5. Input MUX Example

STEREO-INPUT MULTIPLEXER (STEREO MUX)

The LM4868 has two stereo inputs. The MUX CTRL Pin controls which stereo input is active. As shown in the **Truth Table for Logic Inputs**, applying 0V to the MUX CTRL input activates stereo input 1, whereas applying V_{DD} to the MUX CTRL inputs activates stereo input 2. To ensure correct amplifier operation, unused MUX inputs should be tied to GND.

Typical LM4868 applications use the MUX to switch between two stereo input signals. Each stereo channel's gain can be tailored to produce the required output signal level by choosing the appropriate input and feedback resistor ratio.

Another configuration uses the MUX to select two different gains or frequency compensated gains that amplify a single pair of stereo input signals. *Figure 5* shows two different feedback networks, Network 1 and Network 2. Network 1 produces increasing gain as the input signal's frequency decreases. This can be used to compensate a small, full-range speaker's low frequency response roll-off. Network 2 sets the gain for an alternate load such as headphones. The circuit in *Figure 6* uses Network 1 when driving external speakers, switching to Network 2 when headphones are connected. The normally closed control switch in *Figure 6*'s headphone jack connects to the MUX CTRL pin. When headphones are connected, the LM4868's internal pull-up that applies V_{DD} to the HP-IN and the external 100kΩ resistor applies V_{DD} to MUX CTRL pin. Simultaneously applying these control voltages automatically selects the amplifier (headphone or bridge) and switches the gain (MUX channel selection). Alternatively, leaving the MUX CTRL pin independently accessible allows a user to select bass boost as needed. This alternative user-selectable bass-boost scheme requires connecting equal ratio resistor feedback networks to each MUX input channel. The value of the resistor in the RC network is chosen to give a gain that is necessary to achieve the desired bass-boost.

Switching between the MUX channels may change the input signal source or the feedback resistor network. During the channel switching transition, the average voltage level

Application Information (Continued)

present on the internal amplifier's input may change. This change can slew at a rate that may produce audible voltage transients or clicks in the amplifier's output signal. Using the MUX to select between two vastly dissimilar gains is a typical transient-producing situation. As the MUX is switched, an audible click may occur as the gain suddenly changes.

PIN OUT COMPATIBILITY WITH THE LM4863

The LM4868 pin out was designed to simplify replacing the LM4863: except for the four Pins (-IN A₂, MUX CTRL, -IN B₂, and NC) that implement the LM4868's extra functionality, the LM4868MT/MTE and LM4863MT/MTE pin outs match. (Note 19)

Note 19: If the LM4868 replaces an LM4863 and the input MUX circuitry is not being used, the LM4868 MUX CTRL pin must be tied to V_{DD} or GND and the unused MUX inputs must be connected to GND.

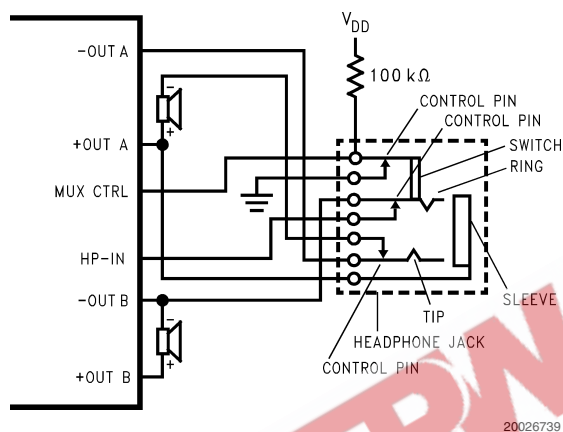

FIGURE 6. As configured, connecting headphones to this jack automatically selects the stereo headphone amplifier and, with the additional NC switch, changes MUX channels (Network 2 in Figure 5)

EXPOSED-DAP MOUNTING CONSIDERATIONS

The LM4868's exposed-DAP (die attach paddle) packages (MTE and LQ) provide a low thermal resistance between the die and the PCB to which the part is mounted and soldered. This allows rapid heat transfer from the die to the surrounding PCB copper area heatsink, copper traces, ground plane, and finally, surrounding air. The result is a low voltage audio power amplifier that produces 2.4W dissipation in a 4Ω load at $\leq 1\%$ THD+N and over 3W in a 3Ω load at 10% THD+N. This high power is achieved through careful consideration of necessary thermal design. Failing to optimize thermal design may compromise the LM4868's high power performance and activate unwanted, though necessary, thermal shutdown protection.

The MTE and LQ packages must have their DAPs soldered to a copper pad on the PCB. The DAP's PCB copper pad is then, ideally, connected to a large plane of continuous unbroken copper. This plane forms a thermal mass, heat sink, and radiation area. Place the heat sink area on either outside plane in the case of a two-sided or multi-layer PCB. (The heat sink area can also be placed on an inner layer of a multi-layer board. The thermal resistance, however, will be higher.) Connect the DAP copper pad to the inner layer or backside copper heat sink area with 32 (4 X 8) (MTE) or 6 (3 X 2) (LQ) vias. The via diameter should be 0.012in - 0.013in

with a 1.27mm pitch. Ensure efficient thermal conductivity by plugging and tenting the vias with plating and solder mask, respectively.

Best thermal performance is achieved with the largest practical copper heat sink area. If the heatsink and amplifier share the same PCB layer, a nominal 2.5in² (min) area is necessary for 5V operation with a 4Ω load. Heatsink areas not placed on the same PCB layer as the LM4868 should be 5in² (min) for the same supply voltage and load resistance. The last two area recommendations apply for 25°C ambient temperature. Increase the area to compensate for ambient temperatures above 25°C. In systems using cooling fans, the LM4868MTE can take advantage of forced air cooling. With an air flow rate of 450 linear-feet per minute and a 2.5in² exposed copper or 5.0in² inner layer copper plane heatsink, the LM4868MTE can continuously drive a 3Ω load to full power. The LM4868LQ achieves the same output power level without forced-air cooling. In all circumstances and under all conditions, the junction temperature must be held below 150°C to prevent activating the LM4868's thermal shutdown protection. The LM4868's power de-rating curve in the **Typical Performance Characteristics** shows the maximum power dissipation versus temperature. Example PCB layouts for the exposed-DAP TSSOP and LQ packages are shown in the **Demonstration Board Layout** section. Further detailed and specific information concerning PCB layout and fabrication and mounting an LQ (LLP) is found in National Semiconductor's AN1187.

PCB LAYOUT AND SUPPLY REGULATION CONSIDERATIONS FOR DRIVING 3Ω AND 4Ω LOADS

Power dissipated by a load is a function of the voltage swing across the load and the load's impedance. As load impedance decreases, load dissipation becomes increasingly dependent on the interconnect (PCB trace and wire) resistance between the amplifier output pins and the load's connections. Residual trace resistance causes a voltage drop, which results in power dissipated in the trace and not in the load as desired. For example, 0.1Ω trace resistance reduces the output power dissipated by a 4Ω load from 2.1W to 2.0W. The problem of decreased load dissipation is exacerbated as load impedance decreases. Therefore, to maintain the highest load dissipation and widest output voltage swing, PCB traces that connect the output pins to a load must be as wide as possible.

Poor power supply regulation adversely affects maximum output power. A poorly regulated supply's output voltage decreases with increasing load current. Reduced supply voltage causes decreased headroom, output signal clipping, and reduced output power. Even with tightly regulated supplies, trace resistance creates the same effects as poor supply regulation. Therefore, making the power supply traces as wide as possible helps maintain full output voltage swing.

BRIDGE CONFIGURATION EXPLANATION

As shown in *Figure 4*, the LM4868 consists of two pairs of operational amplifiers, forming a two-channel (channel A and channel B) stereo amplifier. (Though the following discusses channel A, it applies equally to channel B.) External resistors R_f and R_i set the closed-loop gain of Amp1A, whereas two internal 20kΩ resistors set Amp2A's gain at -1. The LM4868 drives a load, such as a speaker, connected between the two amplifier outputs, -OUTA and +OUTA.

Figure 4 shows that Amp1A's output serves as Amp2A's input. This results in both amplifiers producing signals iden-

Application Information (Continued)

tical in magnitude, but 180° out of phase. Taking advantage of this phase difference, a load is placed between -OUTA and +OUTA and driven differentially ('commonly referred to as bridge mode'). This results in a differential gain of

$$A_{VD} = 2 * (R_f/R_i) \quad (1)$$

Bridge mode amplifiers are different from single-ended amplifiers that drive loads connected between a single amplifier's output and ground. For a given supply voltage, bridge mode has a distinct advantage over the single-ended configuration: its differential output doubles the voltage swing across the load. This produces four times the output power when compared to a single-ended amplifier under the same conditions. This increase in attainable output power assumes that the amplifier is not current limited or that the output signal is not clipped. To ensure minimum output signal clipping when choosing an amplifier's closed-loop gain, refer to the **Audio Power Amplifier Design** section.

Another advantage of the differential bridge output is no net DC voltage across the load. This is accomplished by biasing channel A's and channel B's outputs at half-supply. This eliminates the coupling capacitor that single supply, single-ended amplifiers require. Eliminating an output coupling capacitor in a single-ended configuration forces a single-supply amplifier's half-supply bias voltage across the load. This increases internal IC power dissipation and may permanently damage loads such as speakers.

POWER DISSIPATION

Power dissipation is a major concern when designing a successful single-ended or bridged amplifier. Equation (2) states the maximum power dissipation point for a single-ended amplifier operating at a given supply voltage and driving a specified output load.

$$P_{DMAX} = (V_{DD})^2 / (2\pi^2 R_L): \text{ Single-Ended} \quad (2)$$

However, a direct consequence of the increased power delivered to the load by a bridge amplifier is higher internal power dissipation for the same conditions.

The LM4868 has two operational amplifiers per channel. The maximum internal power dissipation per channel operating in the bridge mode is four times that of a single-ended amplifier. From Equation (3), assuming a 5V power supply and an 4Ω load, the maximum single channel power dissipation is 1.27W or 2.54W for stereo operation.

$$P_{DMAX} = 4 * (V_{DD})^2 / (2\pi^2 R_L): \text{ Bridge Mode} \quad (3)$$

The LM4868's power dissipation is twice that given by Equation (2) or Equation (3) when operating in the single-ended mode or bridge mode, respectively. Twice the maximum power dissipation point given by Equation (3) must not exceed the power dissipation given by Equation (4):

$$P_{DMAX}' = (T_{JMAX} - T_A) / \theta_{JA} \quad (4)$$

The LM4868's $T_{JMAX} = 150^\circ\text{C}$. In the LQ package soldered to a DAP pad that expands to a copper area of 5in² on a PCB, the LM4868's θ_{JA} is 42°C/W. In the MTE package

soldered to a DAP pad that expands to a copper area of 2in² on a PCB, the LM4868's θ_{JA} is 41°C/W. At any given ambient temperature T_A , use Equation (4) to find the maximum internal power dissipation supported by the IC packaging. Rearranging Equation (4) and substituting P_{DMAX} for P_{DMAX}' results in Equation (5). This equation gives the maximum ambient temperature that still allows maximum stereo power dissipation without violating the LM4868's maximum junction temperature.

$$T_A = T_{JMAX} - 2 * P_{DMAX} \theta_{JA} \quad (5)$$

For a typical application with a 5V power supply and an 4Ω load, the maximum ambient temperature that allows maximum stereo power dissipation without exceeding the maximum junction temperature is approximately 43°C for the LQ package and 45°C for the MTE package.

$$T_{JMAX} = P_{DMAX} \theta_{JA} + T_A \quad (6)$$

Equation (6) gives the maximum junction temperature T_{JMAX} . If the result violates the LM4868's 150°C, reduce the maximum junction temperature by reducing the power supply voltage or increasing the load resistance. Further allowance should be made for increased ambient temperatures.

The above examples assume that a device is a surface mount part operating around the maximum power dissipation point. Since internal power dissipation is a function of output power, higher ambient temperatures are allowed as output power or duty cycle decreases.

If the result of Equation (2) is greater than that of Equation (3), then decrease the supply voltage, increase the load impedance, or reduce the ambient temperature. If these measures are insufficient, a heat sink can be added to reduce θ_{JA} . The heat sink can be created using additional copper area around the package, with connections to the ground pin(s), supply pin and amplifier output pins. External, solder attached SMT heatsinks such as the Thermalloy 7106D can also improve power dissipation. When adding a heat sink, the θ_{JA} is the sum of θ_{JC} , θ_{CS} , and θ_{SA} . (θ_{JC} is the junction-to-case thermal impedance, θ_{CS} is the case-to-sink thermal impedance, and θ_{SA} is the sink-to-ambient thermal impedance.) Refer to the **Typical Performance Characteristics** curves for power dissipation information at lower output power levels.

POWER SUPPLY BYPASSING

As with any power amplifier, proper supply bypassing is critical for low noise performance and high power supply rejection. Applications that employ a 5V regulator typically use a 10μF in parallel with a 0.1μF filter capacitors to stabilize the regulator's output, reduce noise on the supply line, and improve the supply's transient response. However, their presence does not eliminate the need for a local 1.0μF tantalum bypass capacitance connected between the LM4868's supply pins and ground. Do not substitute a ceramic capacitor for the tantalum. Doing so may cause oscillation. Keep the length of leads and traces that connect capacitors between the LM4868's power supply pin and ground as short as possible. Connecting a 1μF capacitor, C_B , between the BYPASS pin and ground improves the internal bias voltage's stability and improves the amplifier's PSRR. The PSRR improvements increase as the bypass pin capacitor value increases. Too large, however, increases turn-on time and can compromise the amplifier's click and

Application Information (Continued)

pop performance. The selection of bypass capacitor values, especially C_B , depends on desired PSRR requirements, click and pop performance (as explained in the section, **Proper Selection of External Components**), system cost, and size constraints.

MICRO-POWER SHUTDOWN

The voltage applied to the SHUTDOWN pin controls the LM4868's shutdown function. Activate micro-power shutdown by applying V_{DD} to the SHUTDOWN pin. When active, the LM4868's micro-power shutdown feature turns off the amplifier's bias circuitry, reducing the supply current. The logic threshold is typically $V_{DD}/2$. The low 0.7 μ A typical shutdown current is achieved by applying a voltage that is as near as V_{DD} as possible to the SHUTDOWN pin. A voltage that is less than V_{DD} may increase the shutdown current. Table 1 shows the logic signal levels that activate and deactivate micro-power shutdown and headphone amplifier op-

eration. **To ensure that the output signal remains transient-free, do not cycle the shutdown function faster than 1Hz.**

There are a few ways to control the micro-power shutdown. These include using a single-pole, single-throw switch, a microprocessor, or a microcontroller. When using a switch, connect an external 100k Ω pull-up resistor between the SHUTDOWN pin and V_{DD} . Connect the switch between the SHUTDOWN pin and ground. Select normal amplifier operation by closing the switch. Opening the switch connects the SHUTDOWN pin to V_{DD} through the pull-up resistor, activating micro-power shutdown. The switch and resistor guarantee that the SHUTDOWN pin will not float. This prevents unwanted state changes. In a system with a microprocessor or a microcontroller, use a digital output to apply the control voltage to the SHUTDOWN pin. Driving the SHUTDOWN pin with active circuitry eliminates the pull up resistor.

Truth Table for Logic Inputs

SHUTDOWN PIN	HP-IN PIN	MUX CHANNEL INPUT SELECT	OPERATIONAL MODE (MUX INPUT CHANNEL #)
Logic Low	= -OUTB signal	Logic Low	Bridged amplifiers (1)
Logic Low	= -OUTB signal	Logic High	Bridged amplifiers (2)
Logic Low	\neq -OUTB signal	Logic Low	Single-ended amplifiers (1)
Logic Low	\neq -OUTB signal	Logic High	Single-ended amplifiers (2)
Logic High	X	X	Micro-power shutdown

HEADPHONE (SINGLE-ENDED) AMPLIFIER OPERATION

An internal pull-up circuit is connected to the HP-IN (pin 20) headphone amplifier control pin. When this pin is left unconnected, V_{DD} is applied to the HP-IN. This turns off Amp2B and switches Amp2A's input signal from an audio signal to the $V_{DD}/2$ voltage present on pin 14. The result is muted bridge-connected loads. Quiescent current consumption is reduced when the IC is in this single-ended mode.

Figure 8 shows the implementation of the LM4868's headphone control function. An internal comparator with a nominal 400mV offset monitors the signal present at the -OUTB output. It compares this signal against the signal applied to the HP-IN pin. When these signals are equal, as is the case when a BTL is connected to the amplifier, the comparator forces the LM4868 to maintain bridged-amplifier operation. When the HP-IN pin is externally floated, such as when headphones are connected to the jack shown in Figure 8, and internal pull-up forces V_{DD} on the internal comparator's HP-IN inputs. This changes the comparator's output state and enables the headphone function: it turns off Amp2B, switches Amp2A's input signal from an audio signal to the $V_{DD}/2$ voltage present on pin 14, and mutes the bridge-connected loads. Amp1A and Amp1B drive the headphones.

Figure 8 also shows the suggested headphone jack electrical connections. The jack is designed to mate with a three-wire plug. The plug's tip and ring should each carry one of the two stereo output signals, whereas the sleeve

provides the return to Amp2A. A headphone jack with one control pin contact is sufficient to drive the HP-IN pin when connecting headphones.

A switch can replace the headphone jack contact pin. When a switch shorts the HP-IN pin to V_{DD} , bridge-connected speakers are muted and Amp1A and Amp2A drive a pair of headphones. When a switch shorts the HP-IN pin to GND, the LM4868 operates in bridge mode. If headphone drive is not needed, short the HP-IN pin to the -OUTB pin.

Figure 7 shows an optional resistor connected between the amplifier output that drives the headphone jack sleeve and ground. This resistor provides a ground path that suppressed power supply hum. This hum may occur in applications such as notebook computers in a shutdown condition and connected to an external powered speaker. The resistor's 100 Ω value is a suggested starting point. Its final value must be determined based on the tradeoff between the amount of noise suppression that may be needed and minimizing the additional current drawn by the resistor (25mA for a 100 Ω resistor and a 5V supply).

ESD Protection

As stated in the Absolute Maximum Ratings, pin 28 on the MT and MH packages have a maximum ESD susceptibility rating of 8000V. For higher ESD voltages, the addition of a PCDN042 dual transil (from California Micro Devices), as shown in Figure 7, will provide additional protection.

Application Information (Continued)

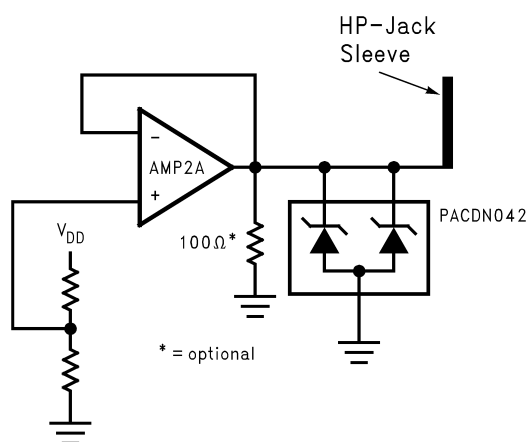

200267A1

FIGURE 7. The PCDN042 provides additional ESD protection beyond the 8000V shown in the Absolute Maximum Ratings for the AMP2A output

Single-Ended Output Power Performance and Measurement Considerations

The LM4868 delivers clean, low distortion SE output power into loads that are greater than 10Ω . As an example, output power for 16Ω and 32Ω loads are shown in the **Typical Performance Characteristic** curves. For loads less than 10Ω , the LM4876 can typically supply 180mW of low distortion power. However, when higher dissipation is desired in loads less than 10Ω , a dramatic increase in THD+N may occur. This is normal operation and does not indicate that proper functionality has ceased. When a jump from moderate to excessively high distortion is seen, simply reducing the output voltage swing will restore the clean, low distortion SE operation.

The dramatic jump in distortion for loads less than 10Ω occurs when current limiting circuitry activates. During SE operation, AMP2A (refer to Figure 4) drives the headphone sleeve. An on-board circuit monitors this amplifier's output current. The sudden increase in THD+N is caused by the current limit circuitry forcing AMP2A into a high-impedance output mode. When this occurs, the output waveform has discontinuities that produce large amounts of distortion. It has been observed that as the output power is steadily increased, the distortion may jump from 5% to greater than 35%. Indeed, 10% THD+N may not actually be achievable.

Using the Single-Ended Output for Line Level Applications

Some samples of the LM4868 may exhibit small amplitude, high frequency oscillation when the SE output is connected to a line-level input. This oscillation can be eliminated by connecting a 5%, 300Ω resistor between Amp2A's output pin and each amplifier, AMP1A and AMP1B, output.

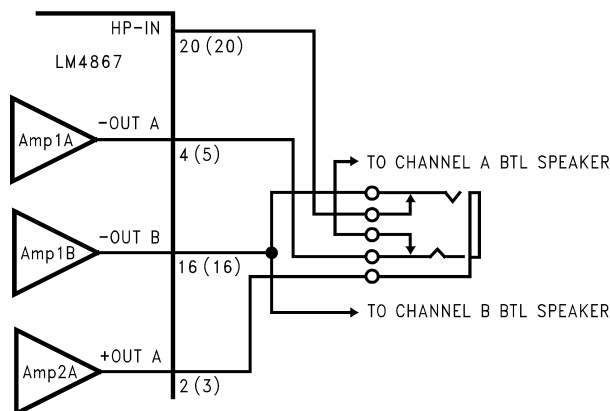

20026724

FIGURE 8. Headphone Circuit
(Pin numbers in () are for the 20-pin MTE and MT packages.)

SELECTING EXTERNAL COMPONENTS

Input Capacitor Value Selection

Amplifying the lowest audio frequencies requires high value input coupling capacitor (C_i in Figure 4). A high value capacitor can be expensive and may compromise space efficiency in portable designs. In many cases, however, the speakers used in portable systems, whether internal or external, have little ability to reproduce signals below 150Hz. Applications using speakers with this limited frequency response reap little improvement by using large input capacitor.

Besides effecting system cost and size, C_i has an affect on the LM4868's click and pop performance. When the supply voltage is first applied, a transient (pop) is created as the charge on the input capacitor changes from zero to a quiescent state. The magnitude of the pop is directly proportional to the input capacitor's size. Higher value capacitors need more time to reach a quiescent DC voltage (usually $V_{DD}/2$) when charged with a fixed current. The amplifier's output charges the input capacitor through the feedback resistor, R_f . Thus, pops can be minimized by selecting an input capacitor value that is no higher than necessary to meet the desired -3dB frequency and is between $0.14C_B$ and $0.20C_B$. A shown in Figure 4, the input resistor (R_i) and the input capacitor, C_i produce a -3dB high pass filter cutoff frequency that is found using Equation (7).

$$f_{-3\text{dB}} = 1/(2\pi R_{iN} C_i) \quad (7)$$

As an example when using a speaker with a low frequency limit of 150Hz, C_i , using Equation (4) is $0.063\mu\text{F}$. The $1.0\mu\text{F}$ C_i shown in Figure 4 allows the LM4868 to drive high efficiency, full range speaker whose response extends below 30Hz.

Bypass Capacitor Value Selection

Besides minimizing the input capacitor size, careful consideration should be paid to value of C_B , the capacitor connected to the BYPASS pin. Since C_B determines how fast the LM4868 settles to quiescent operation, its value is critical when minimizing turn-on pops. The slower the LM4868's outputs ramp to their quiescent DC voltage (nominally 1/2

Application Information (Continued)

V_{DD}), the smaller the turn-on pop. Choosing C_B equal to $1.0\mu\text{F}$ along with a small value of C_i (in the range of $0.1\mu\text{F}$ to $0.39\mu\text{F}$), produces a click-less and pop-less shutdown function. As discussed above, choosing C_i no larger than necessary for the desired bandwidth helps minimize clicks and pops. C_B 's value should be in the range of 5 times to 7 times the value of C_i . This ensures that output transients are eliminated when power is first applied or the LM4868 resumes operation after shutdown.

OPTIMIZING CLICK AND POP REDUCTION PERFORMANCE

The LM4868 contains circuitry that eliminates turn-on and shutdown transients ("clicks and pops") and transients that could occur when switching between BTL speakers and single-ended headphones. For this discussion, turn-on refers to either applying the power supply voltage or when the shutdown mode is deactivated. While the power supply is ramping to its final value, the LM4868's internal amplifiers are configured as unity gain buffers and are disconnected from the -OUT and +OUT pins. An internal current source changes the voltage of the BYPASS pin in a controlled, linear manner. Ideally, the input and outputs track the voltage applied to the BYPASS pin. The gain of the internal amplifiers remains unity until the voltage on the bypass pin reaches $1/2 V_{DD}$. As soon as the voltage on the bypass pin is stable, the device becomes fully operational and the amplifier outputs are reconnected to the -OUT and +OUT pins. Although the BYPASS pin current cannot be modified, changing the size of C_B alters the device's turn-on time. There is a linear relationship between the size of C_B and the turn-on time. Here are some typical turn-on times for various values of C_B :

C_B	T_{ON}
$0.01\mu\text{F}$	3ms
$0.1\mu\text{F}$	30ms
$0.22\mu\text{F}$	63ms
$0.47\mu\text{F}$	134ms
$1.0\mu\text{F}$	300ms
$2.2\mu\text{F}$	630ms

In order eliminate "clicks and pops", all capacitors must be discharged before turn-on. Rapidly switching V_{DD} may not allow the capacitors to fully discharge, which may cause "clicks and pops".

NO LOAD STABILITY

The LM4868 may exhibit low level oscillation when the load resistance is greater than $10\text{k}\Omega$. This oscillation only occurs as the output signal swings near the supply voltages. Prevent this oscillation by connecting a $5\text{k}\Omega$ between the output pins and ground.

AUDIO POWER AMPLIFIER DESIGN

Audio Amplifier Design: Driving 1W into an 8Ω Load

The following are the desired operational parameters:

Power Output:	$1 W_{RMS}$
Load Impedance:	8Ω

Input Level:	$1 V_{RMS}$
Input Impedance:	$20\text{k}\Omega$
Bandwidth:	$100\text{ Hz} - 20\text{ kHz} \pm 0.25\text{ dB}$

The design begins by specifying the minimum supply voltage necessary to obtain the specified output power. One way to find the minimum supply voltage is to use the Output Power vs Supply Voltage curve in the **Typical Performance Characteristics** section. Another way, using Equation (8), is to calculate the peak output voltage necessary to achieve the desired output power for a given load impedance. To account for the amplifier's dropout voltage, two additional voltages, based on the Dropout Voltage vs Supply Voltage in the **Typical Performance Characteristics** curves, must be added to the result obtained by Equation (8). The result is Equation (9).

$$V_{\text{outpeak}} = \sqrt{(2R_L P_O)} \quad (8)$$

$$V_{DD} \geq (V_{\text{OUTPEAK}} + (V_{\text{ODTOP}} + V_{\text{ODBOT}})) \quad (9)$$

The Output Power vs Supply Voltage graph for an 8Ω load indicates a minimum supply voltage of 4.6V . This is easily met by the commonly used 5V supply voltage. The additional voltage creates the benefit of headroom, allowing the LM4868 to produce peak output power in excess of 1W without clipping or other audible distortion. The choice of supply voltage must also not create a situation that violates of maximum power dissipation as explained above in the **Power Dissipation** section.

After satisfying the LM4868's power dissipation requirements, the minimum differential gain needed to achieve 1W dissipation in an 8Ω load is found using Equation (10).

$$A_{VD} \geq \sqrt{(P_{ORL})/(V_{IN})} = V_{\text{orms}}/V_{\text{inrms}} \quad (10)$$

Thus, a minimum gain of 2.83 allows the LM4868's to reach full output swing and maintain low noise and THD+N performance. For this example, let $A_{VD} = 3$.

The amplifier's overall gain is set using the input (R_i) and feedback (R_f) resistors. With the desired input impedance set at $20\text{k}\Omega$, the feedback resistor is found using Equation (11).

$$R_f/R_i = A_{VD}/2 \quad (11)$$

The value of R_f is $30\text{k}\Omega$.

The last step in this design example is setting the amplifier's -3dB frequency bandwidth. To achieve the desired $\pm 0.25\text{dB}$ pass band magnitude variation limit, the low frequency response must extend to at least one-fifth the lower bandwidth limit and the high frequency response must extend to at least five times the upper bandwidth limit. The gain variation for both response limits is 0.17dB , well within the $\pm 0.25\text{dB}$ desired limit. The results are an

Application Information (Continued)

$$f_L = 100\text{Hz}/5 = 20\text{Hz} \quad (12)$$

and an

$$f_H = 20\text{kHz} \times 5 = 100\text{kHz} \quad (13)$$

As mentioned in the **Selecting Proper External Components** section, R_i and C_i create a highpass filter that sets the amplifier's lower bandpass frequency limit. Find the coupling capacitor's value using Equation (12).

$$C_i \geq 1/(2\pi R_i f_L) \quad (14)$$

The result is

$$1/(2\pi * 20\text{k}\Omega * 20\text{Hz}) = 0.397\mu\text{F} \quad (15)$$

Use a 0.39 μF capacitor, the closest standard value.

The product of the desired high frequency cutoff (100kHz in this example) and the differential gain A_{VD} , determines the

upper passband response limit. With $A_{VD} = 3$ and $f_H = 100\text{kHz}$, the closed-loop gain bandwidth product (GBWP) is 300kHz. This is less than the LM4868's 3.5MHz GBWP. With this margin, the amplifier can be used in designs that require more differential gain while avoiding performance-restricting bandwidth limitations.

RECOMMENDED PRINTED CIRCUIT BOARD LAYOUT

Figures 9 through 13 show the recommended four-layer PC board layout that is optimized for the 24-pin LQ-packaged LM4868 and associated external components. Figures 14 through 18 show the recommended four-layer PC board layout that is optimized for the 24-pin MTE-packaged LM4868 and associated external components. Figures 19 through 21 show the recommended two-layer PC board layout that is optimized for the 20-pin MT-packaged LM4868 and associated external components. These circuits are designed for use with an external 5V supply and 4 Ω speakers (or greater) for the MT-packaged LM4868 or 3 Ω speakers (or greater) for the LQ- and MTE-packaged LM4868.

These circuit boards are easy to use. Apply 5V and ground to the board's V_{DD} and GND pads, respectively. Connect 4 Ω speakers between the board's -OUTA and +OUTA and OUTB and +OUTB pads.

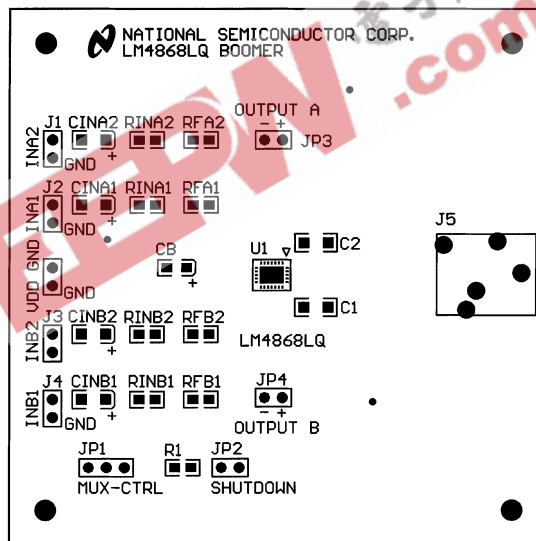

20026778

FIGURE 9. Recommended LQ PC Board Layout: Component-Side Silkscreen

Application Information (Continued)

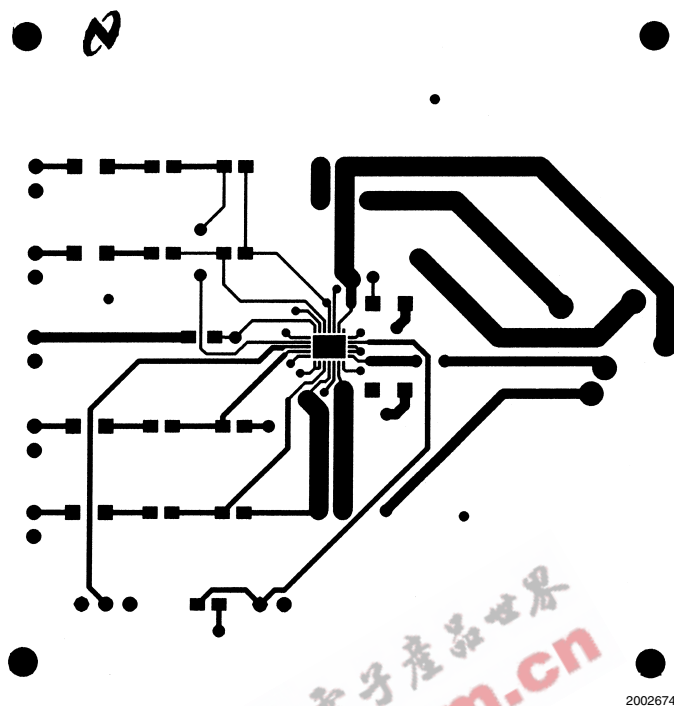

FIGURE 10. Recommended LQ PC Board Layout: Component-Side Layout

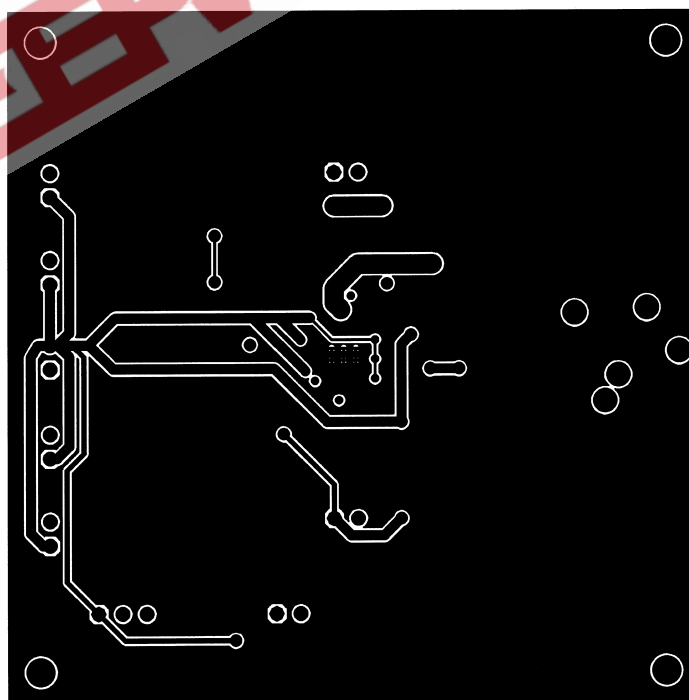

FIGURE 11. Recommended LQ PC Board Layout: Upper Inner-Layer Layout

Application Information (Continued)

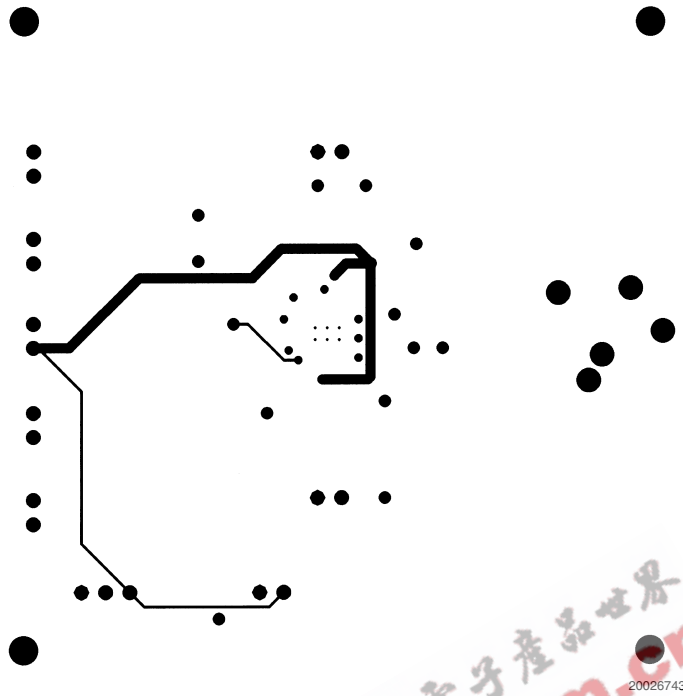

FIGURE 12. Recommended LQ PC Board Layout:
Lower Inner-Layer Layout

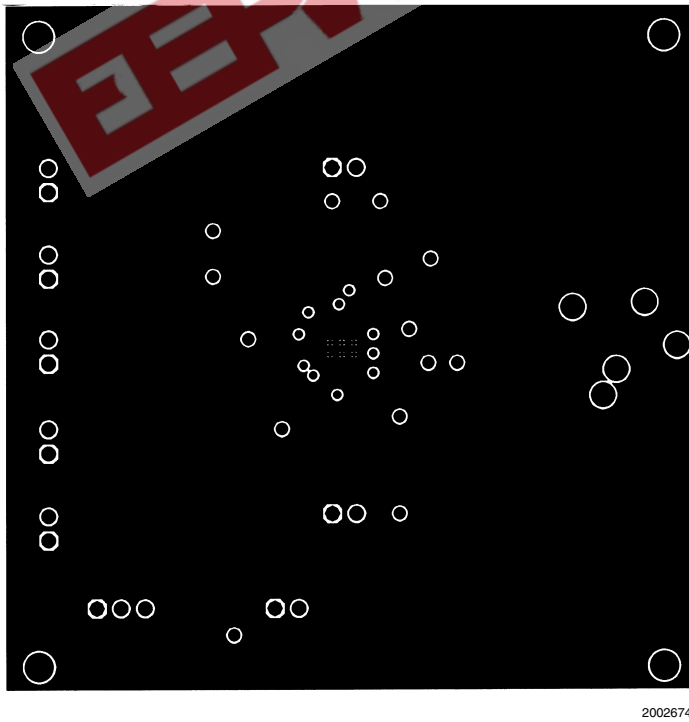

FIGURE 13. Recommended LQ PC Board Layout:
Bottom-Side Layout

Application Information (Continued)

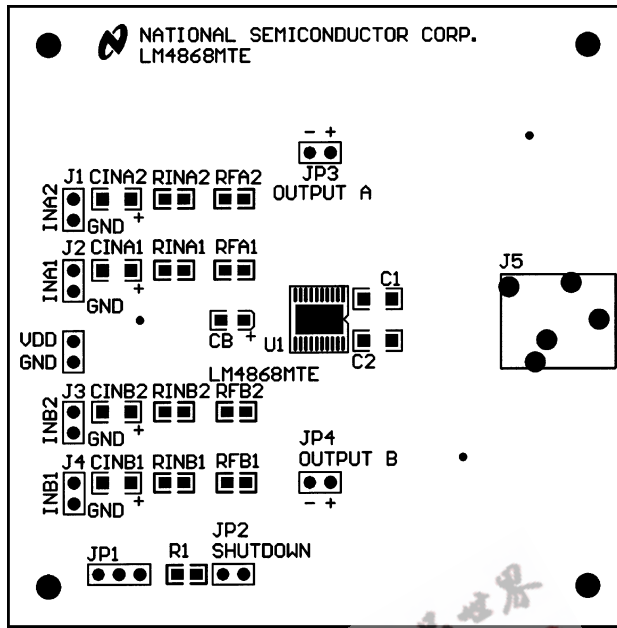

FIGURE 14. Recommended MTE PC Board Layout: Component-Side Silkscreen

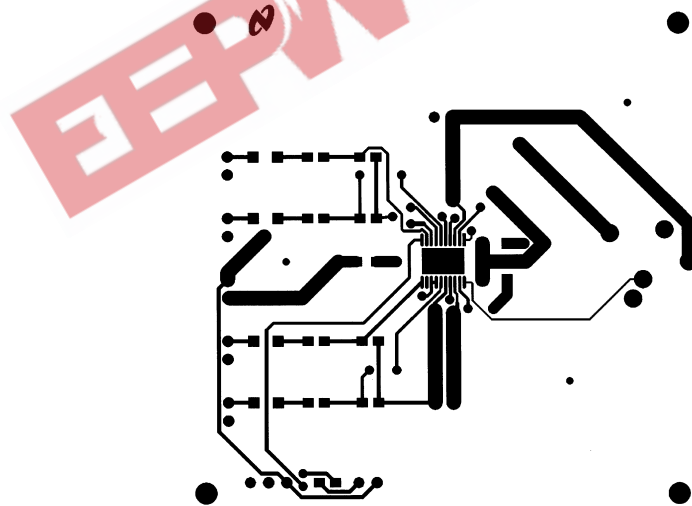
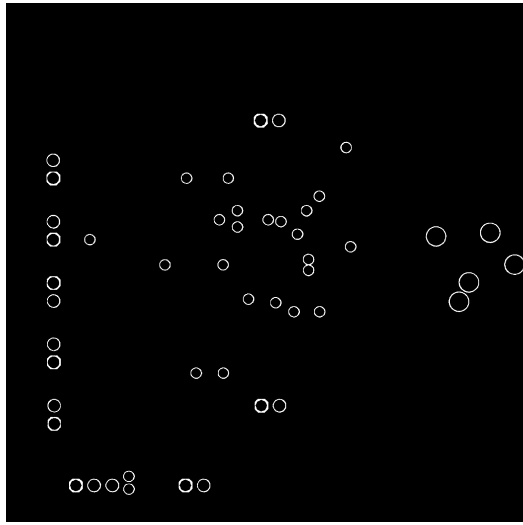

FIGURE 15. Recommended MTE PC Board Layout: Component-Side Layout

Application Information (Continued)



20026772

FIGURE 16. Recommended MTE PC Board Layout: Upper Inner-Layer Layout

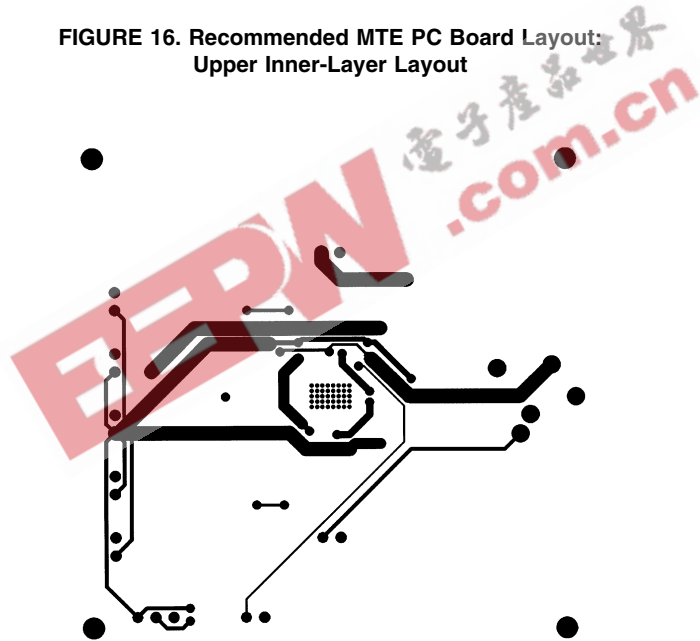

20026773

FIGURE 17. Recommended MTE PC Board Layout: Lower Inner-Layer Layout

Application Information (Continued)

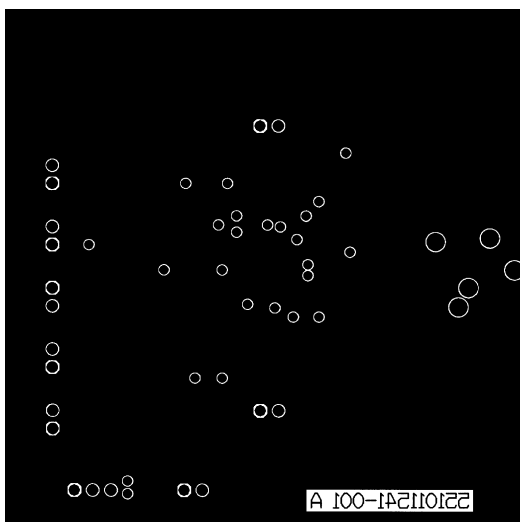

20026774

FIGURE 18. Recommended MTE PC Board Layout: Bottom-Side Layout

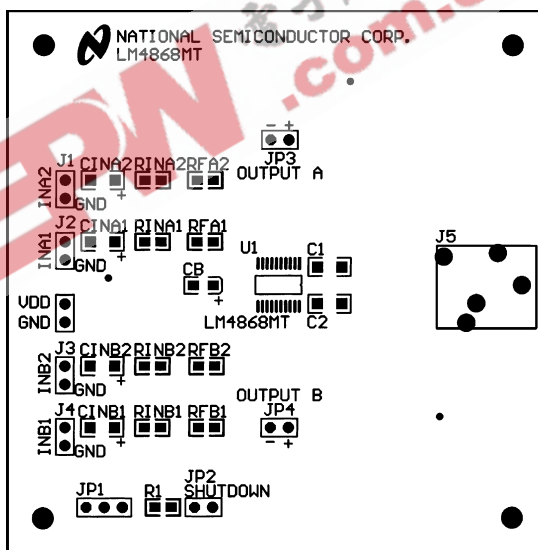

20026775

FIGURE 19. Recommended MT PC Board Layout: Component-Side Silkscreen

Application Information (Continued)

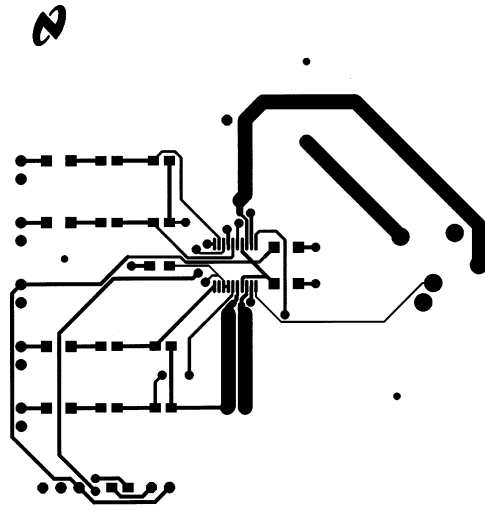

20026776

FIGURE 20. Recommended MT PC Board Layout:
Component-Side Layout

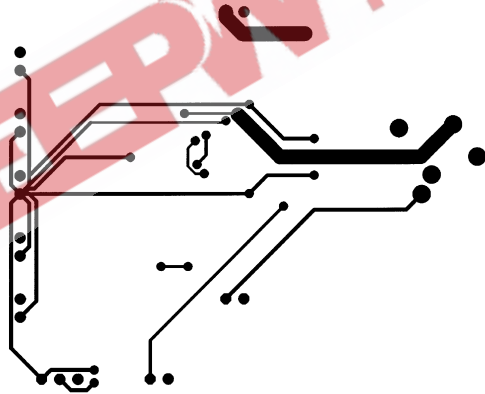
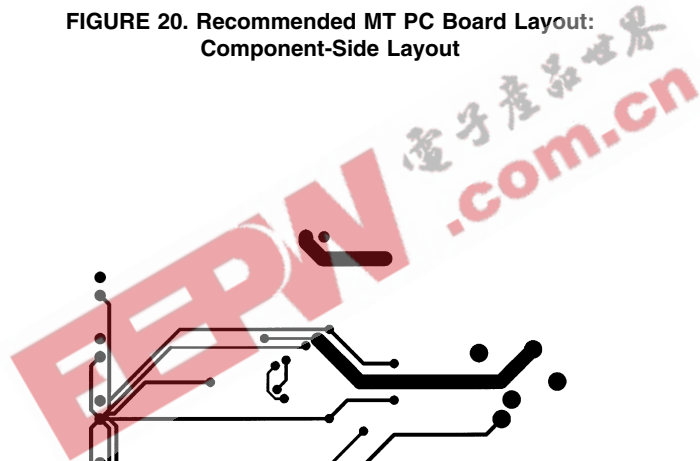

20026777

FIGURE 21. Recommended MT PC Board Layout:
Bottom-Side Layout

Physical Dimensions inches (millimeters) unless otherwise noted

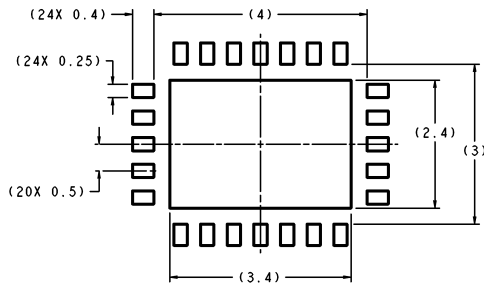

RECOMMENDED LAND PATTERN
1:1 RATION WITH PKG SOLDER PADS

DIMENSIONS ARE IN MILLIMETERS

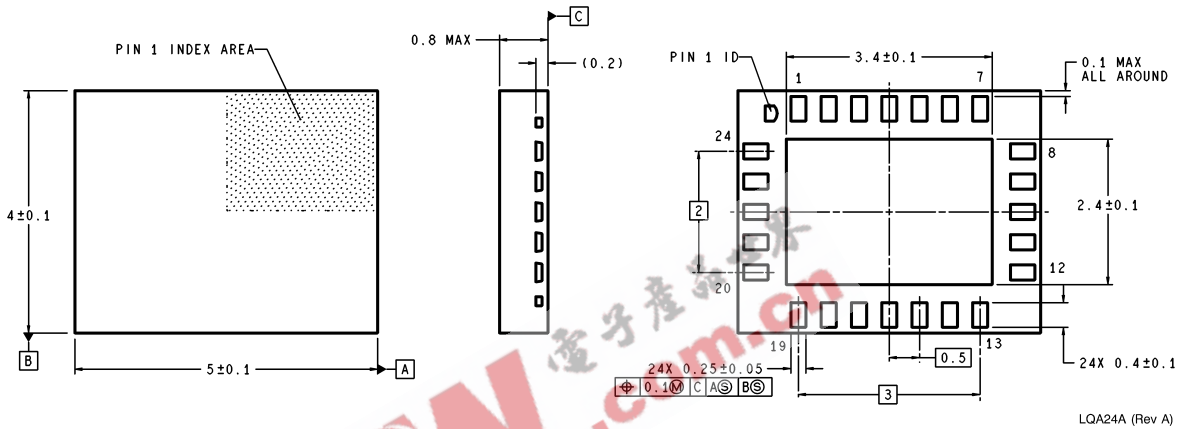

LQA24A (Rev A)

24-Lead MOLDED PKG, Leadless Leadframe Package LLP
Order Number LM4868LQ
NS Package Number LQA24A

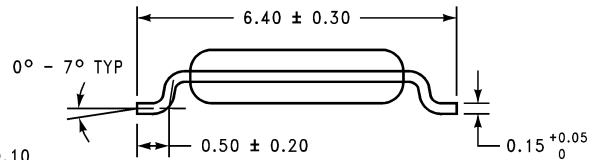
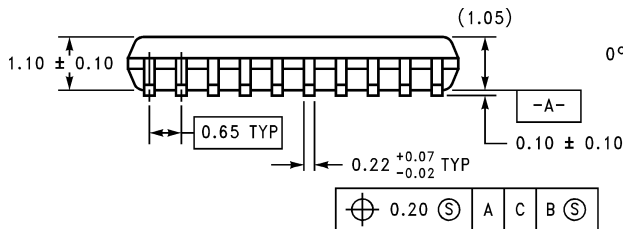
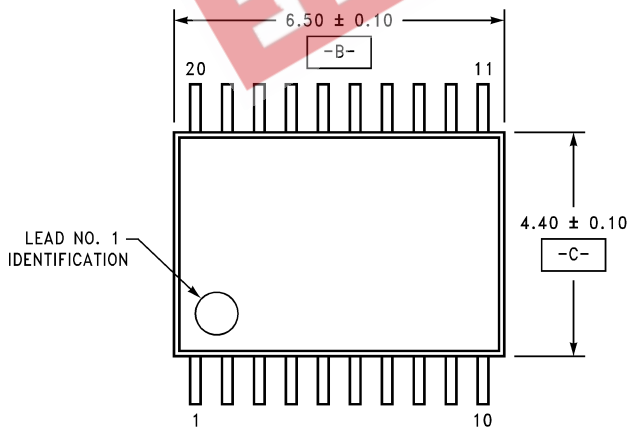

MTA20 (REV. A)

20-Lead MOLDED PKG, TSSOP, JEDEC, 4.4mm BODY WIDTH
Order Number LM4868MT
NS Package Number MTC20

Physical Dimensions inches (millimeters) unless otherwise noted (Continued)

DIMENSIONS ARE IN MILLIMETERS

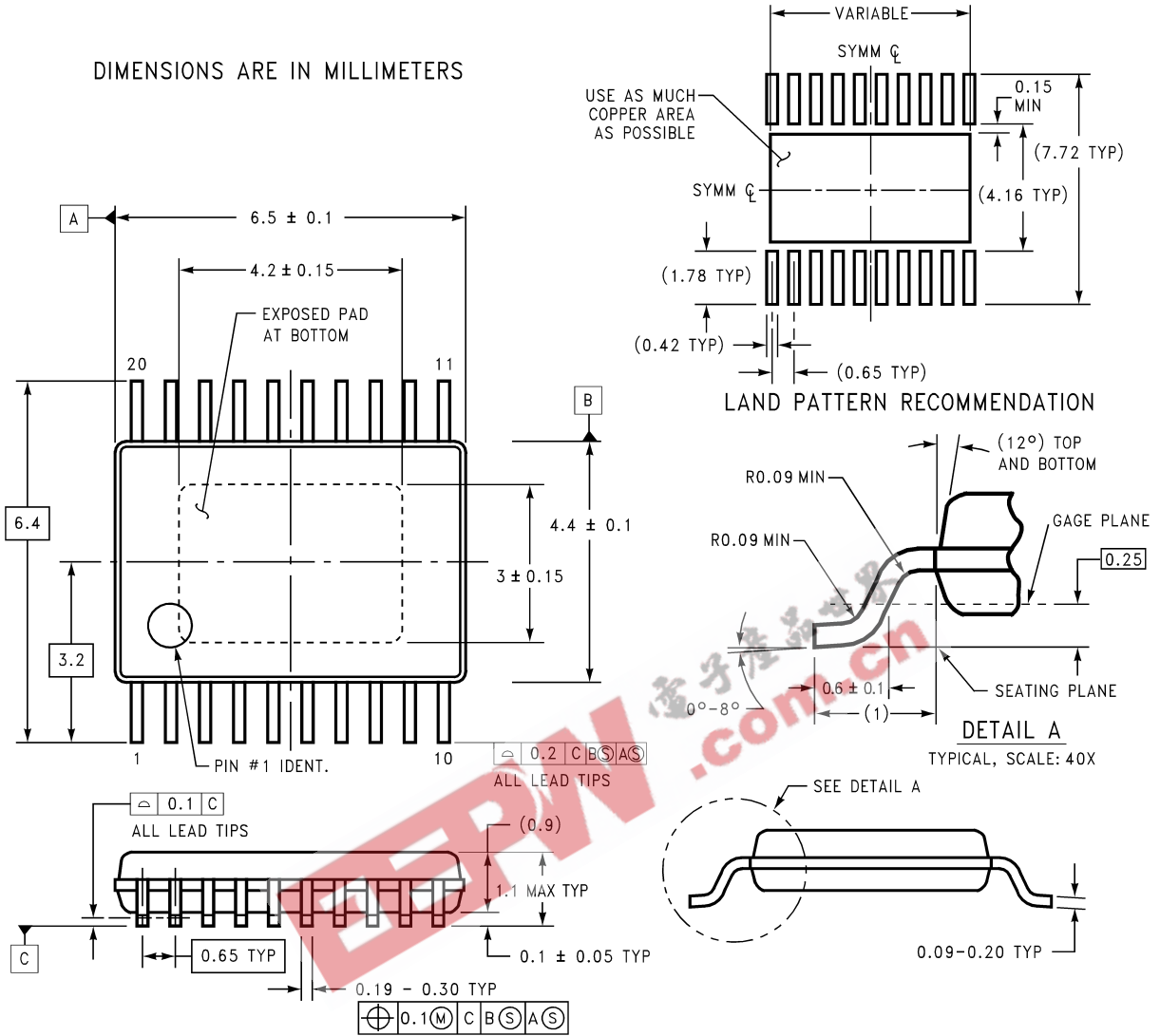

20-Lead MOLDED TSSOP, EXPOSED PAD, 6.5x4.4x0.9mm
Order Number LM4868MTE
NS Package Number MXA20A

MXA20A (REV A)

Notes

EEPW 电子產品世界 .com.cn

LIFE SUPPORT POLICY

NATIONAL'S PRODUCTS ARE NOT AUTHORIZED FOR USE AS CRITICAL COMPONENTS IN LIFE SUPPORT DEVICES OR SYSTEMS WITHOUT THE EXPRESS WRITTEN APPROVAL OF THE PRESIDENT AND GENERAL COUNSEL OF NATIONAL SEMICONDUCTOR CORPORATION. As used herein:

1. Life support devices or systems are devices or systems which, (a) are intended for surgical implant into the body, or (b) support or sustain life, and whose failure to perform when properly used in accordance with instructions for use provided in the labeling, can be reasonably expected to result in a significant injury to the user.
2. A critical component is any component of a life support device or system whose failure to perform can be reasonably expected to cause the failure of the life support device or system, or to affect its safety or effectiveness.



National Semiconductor Corporation
Americas
Email: support@nsc.com

www.national.com

National Semiconductor Europe
Fax: +49 (0) 180-530 85 86
Email: europe.support@nsc.com
Deutsch Tel: +49 (0) 69 9508 6208
English Tel: +44 (0) 870 24 0 2171
Français Tel: +33 (0) 1 41 91 8790

National Semiconductor Asia Pacific Customer Response Group
Tel: 65-2544466
Fax: 65-2504466
Email: ap.support@nsc.com

National Semiconductor Japan Ltd.
Tel: 81-3-5639-7560
Fax: 81-3-5639-7507