

512 Kbit (64K x8) UV EPROM and OTP EPROM

FEATURES SUMMARY

- $5V \pm 10\%$ SUPPLY VOLTAGE in READ OPERATION
- ACCESS TIME: 45ns
- LOW POWER "CMOS" CONSUMPTION:
 - Active Current 30mA
 - Standby Current 100 μ A
- PROGRAMMING VOLTAGE: $12.75V \pm 0.25V$
- PROGRAMMING TIMES of AROUND 6sec.
- ELECTRONIC SIGNATURE
 - Manufacturer Code: 20h
 - Device Code: 3Dh
- PACKAGES
 - Lead-Free Versions

Figure 1. Packages



TABLE OF CONTENTS

FEATURES SUMMARY	1
Figure 1. Packages.....	1
SUMMARY DESCRIPTION	4
Figure 2. Logic Diagram	4
Table 1. Signal Names	4
Figure 3. DIP Connections	5
Figure 4. LCC Connections.....	5
Figure 5. TSOP Connections	5
DEVICE OPERATION	6
Read Mode	6
Standby Mode	6
Table 2. Operating Modes	6
Table 3. Electronic Signature.....	6
Two Line Output Control	6
System Considerations	6
Programming	7
Figure 6. Programming Flowchart.....	7
PRESTO IIB Programming Algorithm	7
Program Inhibit	7
Program Verify	7
Electronic Signature	7
ERASURE OPERATION (APPLIES FOR UV EPROM)	8
MAXIMUM RATING	9
Table 4. Absolute Maximum Ratings.....	9
DC and AC PARAMETERS	10
Table 5. AC Measurement Conditions.....	10
Figure 7. Testing Input Output Waveform.....	10
Figure 8. AC Testing Load Circuit.....	10
Table 6. Capacitance.....	10
Table 7. Read Mode DC Characteristics.....	11
Table 8. Read Mode AC Characteristics	11
Table 9. Read Mode AC Characteristics	12
Figure 9. Read Mode AC Waveforms.....	12
Table 10. Programming Mode DC Characteristics	13
Table 11. Margin Mode AC Characteristics.....	14
Figure 10. Margin Mode AC Waveforms	14
Table 12. Programming Mode AC Characteristics	15
Figure 11. Programming and Verify Modes AC Waveforms.....	15

PACKAGE MECHANICAL	16
Figure 12.FDIP28W - 28 pin Ceramic Frit-seal DIP, with window, Package Outline.	16
Table 13. FDIP28W - 28 pin Ceramic Frit-seal DIP, with window, Package Mechanical Data	16
Figure 13.PDIP28 - 28 pin Plastic DIP, 600 mils width, Package Outline	17
Table 14. PDIP28 - 28 pin Plastic DIP, 600 mils width, Package Mechanical Data	17
Figure 14.PLCC32 - 32 lead Plastic Leaded Chip Carrier, Package Outline	18
Table 15. PLCC32 - 32 lead Plastic Leaded Chip Carrier, Package Mechanical Data	18
Figure 15.TSOP28 - 28 lead Plastic Thin Small Outline, 8 x 13.4 mm, Package Outline	19
Table 16. TSOP28 - 28 lead Plastic Thin Small Outline, 8 x 13.4 mm, Package Mechanical Data	19
PART NUMBERING	20
Table 17. Ordering Information Scheme	20
REVISION HISTORY	21
Table 18. Revision History	21

EEPW 电子产品世界
.com.cn

SUMMARY DESCRIPTION

The M27C512 is a 512 Kbit EPROM offered in the two ranges UV (ultra violet erase) and OTP (one time programmable). It is ideally suited for applications where fast turn-around and pattern experimentation are important requirements and is organized as 65536 by 8 bits.

The FDIP28W (window ceramic frit-seal package) has transparent lid which allows the user to expose the chip to ultraviolet light to erase the bit pattern. A new pattern can then be written to the device by following the programming procedure.

For applications where the content is programmed only one time and erasure is not required, the M27C512 is offered in PDIP28, PLCC32 and TSOP28 (8 x 13.4 mm) packages.

In addition to the standard versions, the packages are also available in Lead-free versions, in compliance with JEDEC Std J-STD-020B, the ST ECO-PACK 7191395 Specification, and the RoHS (Restriction of Hazardous Substances) directive.

Figure 2. Logic Diagram

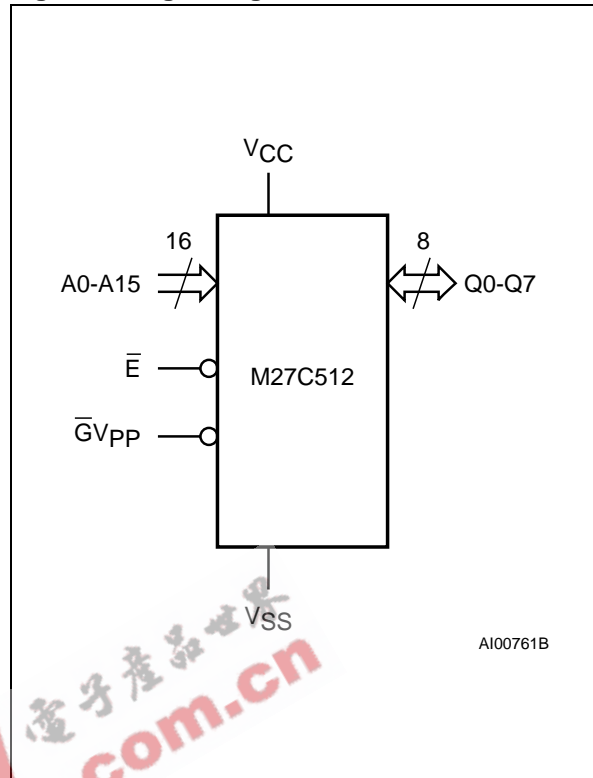

Table 1. Signal Names

A0-A15	Address Inputs
Q0-Q7	Data Outputs
\bar{E}	Chip Enable
$\bar{G}V_{PP}$	Output Enable / Program Supply
VCC	Supply Voltage
VSS	Ground
NC	Not Connected Internally
DU	Don't Use

Figure 3. DIP Connections

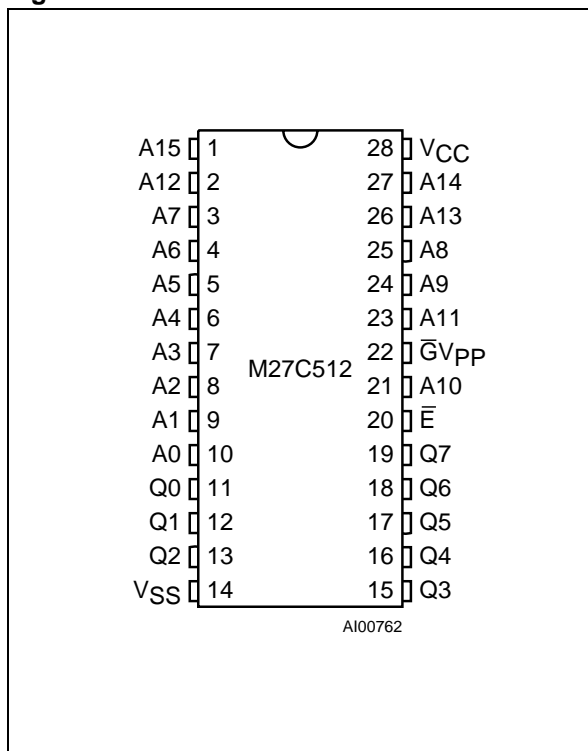

Figure 5. TSOP Connections

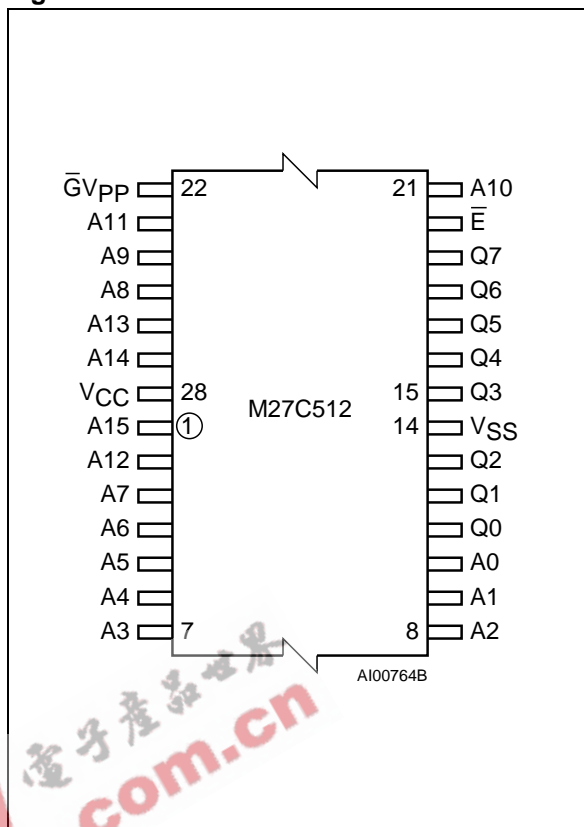
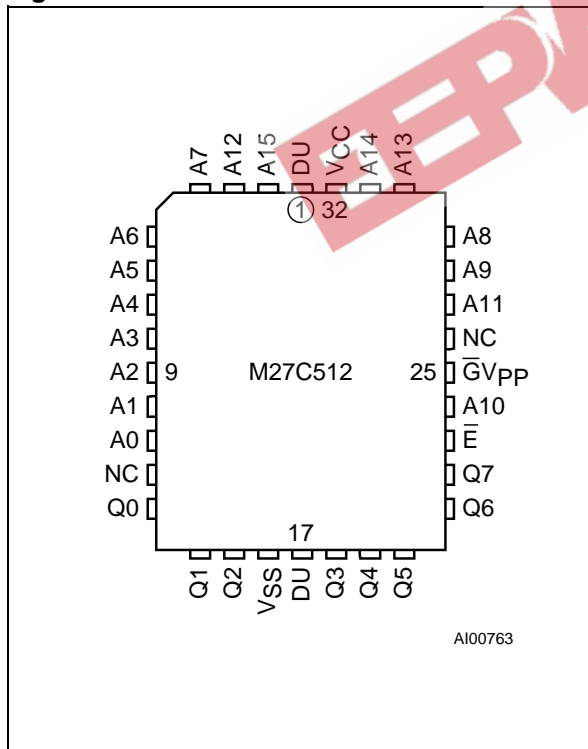

Figure 4. LCC Connections



DEVICE OPERATION

The modes of operations of the M27C512 are listed in the Operating Modes table. A single power supply is required in the read mode. All inputs are TTL levels except for \overline{GV}_{PP} and 12V on A9 for Electronic Signature.

Read Mode

The M27C512 has two control functions, both of which must be logically active in order to obtain data at the outputs. Chip Enable (\overline{E}) is the power control and should be used for device selection. Output Enable (\overline{G}) is the output control and should be used to gate data to the output pins, independent of device selection. Assuming that the ad-

resses are stable, the address access time (t_{AVQV}) is equal to the delay from \overline{E} to output (t_{ELQV}). Data is available at the output after a delay of t_{GLQV} from the falling edge of \overline{G} , assuming that \overline{E} has been low and the addresses have been stable for at least $t_{AVQV} - t_{GLQV}$.

Standby Mode

The M27C512 has a standby mode which reduces the active current from 30mA to 100 μ A. The M27C512 is placed in the standby mode by applying a CMOS high signal to the \overline{E} input. When in the standby mode, the outputs are in a high impedance state, independent of the \overline{GV}_{PP} input.

Table 2. Operating Modes

Mode	\overline{E}	\overline{GV}_{PP}	A9	Q7-Q0
Read	V_{IL}	V_{IL}	X	Data Out
Output Disable	V_{IL}	V_{IH}	X	Hi-Z
Program	V_{IL} Pulse	V_{PP}	X	Data In
Program Inhibit	V_{IH}	V_{PP}	X	Hi-Z
Standby	V_{IH}	X	X	Hi-Z
Electronic Signature	V_{IL}	V_{IL}	V_{ID}	Codes

Note: X = V_{IH} or V_{IL} , V_{ID} = 12V \pm 0.5V.

Table 3. Electronic Signature

Identifier	A0	Q7	Q6	Q5	Q4	Q3	Q2	Q1	Q0	Hex Data
Manufacturer's Code	V_{IL}	0	0	1	0	0	0	0	0	20h
Device Code	V_{IH}	0	0	1	1	1	1	0	1	3Dh

Two Line Output Control

Because EPROMs are usually used in larger memory arrays, the product features a 2 line control function which accommodates the use of multiple memory connection. The two line control function allows:

- the lowest possible memory power dissipation,
- complete assurance that output bus contention will not occur.

For the most efficient use of these two control lines, \overline{E} should be decoded and used as the primary device selecting function, while \overline{G} should be made a common connection to all devices in the array and connected to the READ line from the system control bus. This ensures that all deselected memory devices are in their low power standby mode and that the output pins are only active

when data is required from a particular memory device.

System Considerations

The power switching characteristics of Advanced CMOS EPROMs require careful decoupling of the devices. The supply current, I_{CC} , has three segments that are of interest to the system designer: the standby current level, the active current level, and transient current peaks that are produced by the falling and rising edges of \overline{E} . The magnitude of the transient current peaks is dependent on the capacitive and inductive loading of the device at the output. The associated transient voltage peaks can be suppressed by complying with the two line output control and by properly selected decoupling capacitors. It is recommended that a 0.1 μ F ceramic capacitor be used on every device between V_{CC} and V_{SS} . This should be a high frequency capacitor of low inherent inductance and should be placed as close to the device as possible. In addi-

tion, a 4.7 μ F bulk electrolytic capacitor should be used between V_{CC} and V_{SS} for every eight devices. The bulk capacitor should be located near the power supply connection point. The purpose of the bulk capacitor is to overcome the voltage drop caused by the inductive effects of PCB traces.

Figure 6. Programming Flowchart

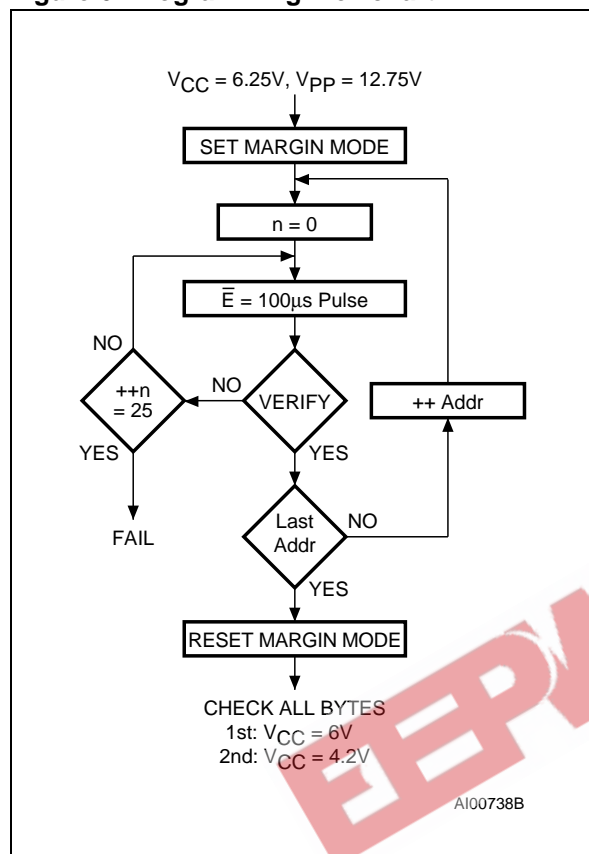

Programming

When delivered (and after each erasure for UV EPROM), all bits of the M27C512 are in the '1' state. Data is introduced by selectively programming '0's into the desired bit locations. Although only '0's will be programmed, both '1's and '0's can be present in the data word. The only way to change a '0' to a '1' is by die exposure to ultraviolet light (UV EPROM). The M27C512 is in the programming mode when V_{PP} input is at 12.75V and \bar{E} is pulsed to V_{IL} . The data to be programmed is applied to 8 bits in parallel to the data output pins. The levels required for the address and data inputs are TTL. V_{CC} is specified to be 6.25V \pm 0.25V. The M27C512 can use PRESTO IIB Programming Algorithm that drastically reduces the programming time (typically less than 6 seconds).

Nevertheless to achieve compatibility with all programming equipments, PRESTO Programming Algorithm can be used as well.

PRESTO IIB Programming Algorithm

PRESTO IIB Programming Algorithm allows the whole array to be programmed with a guaranteed margin, in a typical time of 6.5 seconds. This can be achieved with STMicroelectronics M27C512 due to several design innovations described in the M27C512 datasheet to improve programming efficiency and to provide adequate margin for reliability. Before starting the programming the internal MARGIN MODE circuit is set in order to guarantee that each cell is programmed with enough margin. Then a sequence of 100 μ s program pulses are applied to each byte until a correct verify occurs. No overprogram pulses are applied since the verify in MARGIN MODE provides the necessary margin.

Program Inhibit

Programming of multiple M27C512s in parallel with different data is also easily accomplished. Except for \bar{E} , all like inputs including GV_{PP} of the parallel M27C512 may be common. A TTL low level pulse applied to a M27C512's \bar{E} input, with V_{PP} at 12.75V, will program that M27C512. A high level \bar{E} input inhibits the other M27C512s from being programmed.

Program Verify

A verify (read) should be performed on the programmed bits to determine that they were correctly programmed. The verify is accomplished with G at V_{IL} . Data should be verified with t_{ELQV} after the falling edge of \bar{E} .

Electronic Signature

The Electronic Signature (ES) mode allows the reading out of a binary code from an EPROM that will identify its manufacturer and type. This mode is intended for use by programming equipment to automatically match the device to be programmed with its corresponding programming algorithm. The ES mode is functional in the 25°C \pm 5°C ambient temperature range that is required when programming the M27C512. To activate the ES mode, the programming equipment must force 11.5V to 12.5V on address line A9 of the M27C512. Two identifier bytes may then be sequenced from the device outputs by toggling address line A0 from V_{IL} to V_{IH} . All other address lines must be held at V_{IL} during Electronic Signature mode. Byte 0 ($A0 = V_{IL}$) represents the manufacturer code and byte 1 ($A0 = V_{IH}$) the device identifier code. For the STMicroelectronics M27C512, these two identifier bytes are given in Table 3. and can be read-out on outputs Q7 to Q0.

ERASURE OPERATION (APPLIES FOR UV EPROM)

The erasure characteristics of the M27C512 is such that erasure begins when the cells are exposed to light with wavelengths shorter than approximately 4000 Å. It should be noted that sunlight and some type of fluorescent lamps have wavelengths in the 3000-4000 Å range.

Research shows that constant exposure to room level fluorescent lighting could erase a typical M27C512 in about 3 years, while it would take approximately 1 week to cause erasure when exposed to direct sunlight. If the M27C512 is to be exposed to these types of lighting conditions for extended periods of time, it is suggested that

opaque labels be put over the M27C512 window to prevent unintentional erasure. The recommended erasure procedure for the M27C512 is exposure to short wave ultraviolet light which has wavelength 2537 Å. The integrated dose (i.e. UV intensity x exposure time) for erasure should be a minimum of 15 W-sec/cm². The erasure time with this dosage is approximately 15 to 20 minutes using an ultraviolet lamp with 12000 µW/cm² power rating. The M27C512 should be placed within 2.5 cm (1 inch) of the lamp tubes during the erasure. Some lamps have a filter on their tubes which should be removed before erasure.



MAXIMUM RATING

Stressing the device outside the ratings listed in Table 4. may cause permanent damage to the device. These are stress ratings only, and operation of the device at these, or any other conditions outside those indicated in the Operating sections of

this specification, is not implied. Exposure to Absolute Maximum Rating conditions for extended periods may affect device reliability. Refer also to the STMicroelectronics SURE Program and other relevant quality documents.

Table 4. Absolute Maximum Ratings

Symbol	Parameter	Value	Unit
T _A	Ambient Operating Temperature ⁽³⁾	-40 to 125	°C
T _{BIAS}	Temperature Under Bias	-50 to 125	°C
T _{STG}	Storage Temperature	-65 to 150	°C
T _{LEAD}	Lead Temperature during Soldering	(note 1)	°C
V _{IO} ⁽²⁾	Input or Output Voltage (except A9)	-2 to 7	V
V _{CC}	Supply Voltage	-2 to 7	V
V _{A9} ⁽²⁾	A9 Voltage	-2 to 13.5	V
V _{PP}	Program Supply Voltage	-2 to 14	V

- Note: 1. Compliant with the JEDEC Std J-STD-020B (for small body, Sn-Pb or Pb assembly), the ST ECOPACK[®] 7191395 specification, and the European directive on Restrictions on Hazardous Substances (RoHS) 2002/95/EU.
 2. Minimum DC voltage on Input or Output is -0.5V with possible undershoot to -2.0V for a period less than 20ns. Maximum DC voltage on Output is V_{CC} +0.5V with possible overshoot to V_{CC} +2V for a period less than 20ns.
 3. Depends on range.

DC AND AC PARAMETERS

This section summarizes the operating and measurement conditions, and the DC and AC characteristics of the device. The parameters in the DC and AC Characteristic tables that follow are derived from tests performed under the Measure-

ment Conditions summarized in the relevant tables. Designers should check that the operating conditions in their circuit match the measurement conditions when relying on the quoted parameters.

Table 5. AC Measurement Conditions

	High Speed	Standard
Input Rise and Fall Times	≤ 10ns	≤ 20ns
Input Pulse Voltages	0 to 3V	0.4V to 2.4V
Input and Output Timing Ref. Voltages	1.5V	0.8V and 2V

Figure 7. Testing Input Output Waveform



Figure 8. AC Testing Load Circuit



Table 6. Capacitance

Symbol	Parameter	Test Condition (1,2)	Min	Max	Unit
C _{IN}	Input Capacitance	V _{IN} = 0V		6	pF
C _{OUT}	Output Capacitance	V _{OUT} = 0V		12	pF

Note: 1. T_A = 25°C, f = 1MHz
 2. Sampled only, not 100% tested.

Table 7. Read Mode DC Characteristics

Symbol	Parameter	Test Condition (1)	Min	Max	Unit
I_{LI}	Input Leakage Current	$0V \leq V_{IN} \leq V_{CC}$		± 10	μA
I_{LO}	Output Leakage Current	$0V \leq V_{OUT} \leq V_{CC}$		± 10	μA
I_{CC}	Supply Current	$\bar{E} = V_{IL}, \bar{G} = V_{IL}, I_{OUT} = 0mA, f = 5MHz$		30	mA
I_{CC1}	Supply Current (Standby) TTL	$\bar{E} = V_{IH}$		1	mA
I_{CC2}	Supply Current (Standby) CMOS	$\bar{E} > V_{CC} - 0.2V$		100	μA
I_{PP}	Program Current	$V_{PP} = V_{CC}$		10	μA
V_{IL}	Input Low Voltage		-0.3	0.8	V
$V_{IH}^{(2)}$	Input High Voltage		2	$V_{CC} + 1$	V
V_{OL}	Output Low Voltage	$I_{OL} = 2.1mA$		0.4	V
V_{OH}	Output High Voltage TTL	$I_{OH} = -1mA$	3.6		V
	Output High Voltage CMOS	$I_{OH} = -100\mu A$	$V_{CC} - 0.7V$		V

Note: 1. V_{CC} must be applied simultaneously with or before V_{PP} and removed simultaneously or after V_{PP} .
 2. Maximum DC voltage on Output is $V_{CC} + 0.5V$.

Table 8. Read Mode AC Characteristics

Symbol	Alt	Parameter	Test Condition (1)	M27C512								Unit
				-45 (3)		-60		-70		-80		
				Min	Max	Min	Max	Min	Max	Min	Max	
t_{AVQV}	t_{ACC}	Address Valid to Output Valid	$\bar{E} = V_{IL}, \bar{G} = V_{IL}$	45		60		70		80	ns	
t_{ELQV}	t_{CE}	Chip Enable Low to Output Valid	$\bar{G} = V_{IL}$	45		60		70		80	ns	
t_{GLQV}	t_{OE}	Output Enable Low to Output Valid	$\bar{E} = V_{IL}$	25		30		35		40	ns	
$t_{EHQZ}^{(2)}$	t_{DF}	Chip Enable High to Output Hi-Z	$\bar{G} = V_{IL}$	0	25	0	25	0	30	0	30	ns
$t_{GHQZ}^{(2)}$	t_{DF}	Output Enable High to Output Hi-Z	$\bar{E} = V_{IL}$	0	25	0	25	0	30	0	30	ns
t_{AXQX}	t_{OH}	Address Transition to Output Transition	$\bar{E} = V_{IL}, \bar{G} = V_{IL}$	0		0		0		0		ns

Note: 1. V_{CC} must be applied simultaneously with or before V_{PP} and removed simultaneously or after V_{PP} .
 2. Sampled only, not 100% tested.
 3. Speed obtained with High Speed AC measurement conditions.

Table 9. Read Mode AC Characteristics

Symbol	Alt	Parameter	Test Condition ⁽¹⁾	M27C512								Unit
				-90		-10		-12		-15/-20/-25		
				Min	Max	Min	Max	Min	Max	Min	Max	
t _{AVQV}	t _{ACC}	Address Valid to Output Valid	$\bar{E} = V_{IL}, \bar{G} = V_{IL}$		90		100		120		150	ns
t _{ELQV}	t _{CE}	Chip Enable Low to Output Valid	$\bar{G} = V_{IL}$		90		100		120		150	ns
t _{GLQV}	t _{OE}	Output Enable Low to Output Valid	$\bar{E} = V_{IL}$		40		40		50		60	ns
t _{EHQZ} ⁽²⁾	t _{DF}	Chip Enable High to Output Hi-Z	$\bar{G} = V_{IL}$	0	30	0	30	0	40	0	50	ns
t _{GHQZ} ⁽²⁾	t _{DF}	Output Enable High to Output Hi-Z	$\bar{E} = V_{IL}$	0	30	0	30	0	40	0	50	ns
t _{AXQX}	t _{OH}	Address Transition to Output Transition	$\bar{E} = V_{IL}, \bar{G} = V_{IL}$	0		0		0		0		ns

Note: 1. V_{CC} must be applied simultaneously with or before V_{PP} and removed simultaneously or after V_{PP}.
 2. Sampled only, not 100% tested.

Figure 9. Read Mode AC Waveforms



AI00735B

Table 10. Programming Mode DC Characteristics

Symbol	Parameter	Test Condition ^(1,2)	Min	Max	Unit
I_{LI}	Input Leakage Current	$V_{IL} \leq V_{IN} \leq V_{IH}$		± 10	μA
I_{CC}	Supply Current			50	mA
I_{PP}	Program Current	$\bar{E} = V_{IL}$		50	mA
V_{IL}	Input Low Voltage		-0.3	0.8	V
V_{IH}	Input High Voltage		2	$V_{CC} + 0.5$	V
V_{OL}	Output Low Voltage	$I_{OL} = 2.1\text{mA}$		0.4	V
V_{OH}	Output High Voltage TTL	$I_{OH} = -1\text{mA}$	3.6		V
V_{ID}	A9 Voltage		11.5	12.5	V

Note: 1. $T_A = 25\text{ }^\circ\text{C}$; $V_{CC} = 6.25\text{V} \pm 0.25\text{V}$; $V_{PP} = 12.75\text{V} \pm 0.25\text{V}$

2. V_{CC} must be applied simultaneously with or before V_{PP} and removed simultaneously or after V_{PP} .

EEPW 电子产品世界
.com.cn

Table 11. Margin Mode AC Characteristics

Symbol	Alt	Parameter	Test Condition (1,2)	Min	Max	Unit
t_{A9HVPH}	t_{AS9}	V_{A9} High to V_{PP} High		2		μs
t_{VPHEL}	t_{VPS}	V_{PP} High to Chip Enable Low		2		μs
t_{A10HEH}	t_{AS10}	V_{A10} High to Chip Enable High (Set)		1		μs
t_{A10LEH}	t_{AS10}	V_{A10} Low to Chip Enable High (Reset)		1		μs
t_{EXA10X}	t_{AH10}	Chip Enable Transition to V_{A10} Transition		1		μs
t_{EXVPX}	t_{VPH}	Chip Enable Transition to V_{PP} Transition		2		μs
t_{VPXA9X}	t_{AH9}	V_{PP} Transition to V_{A9} Transition		2		μs

Note: 1. $T_A = 25\text{ }^\circ\text{C}$; $V_{CC} = 6.25\text{V} \pm 0.25\text{V}$; $V_{PP} = 12.75\text{V} \pm 0.25\text{V}$
 2. V_{CC} must be applied simultaneously with or before V_{PP} and removed simultaneously or after V_{PP} .

Figure 10. Margin Mode AC Waveforms

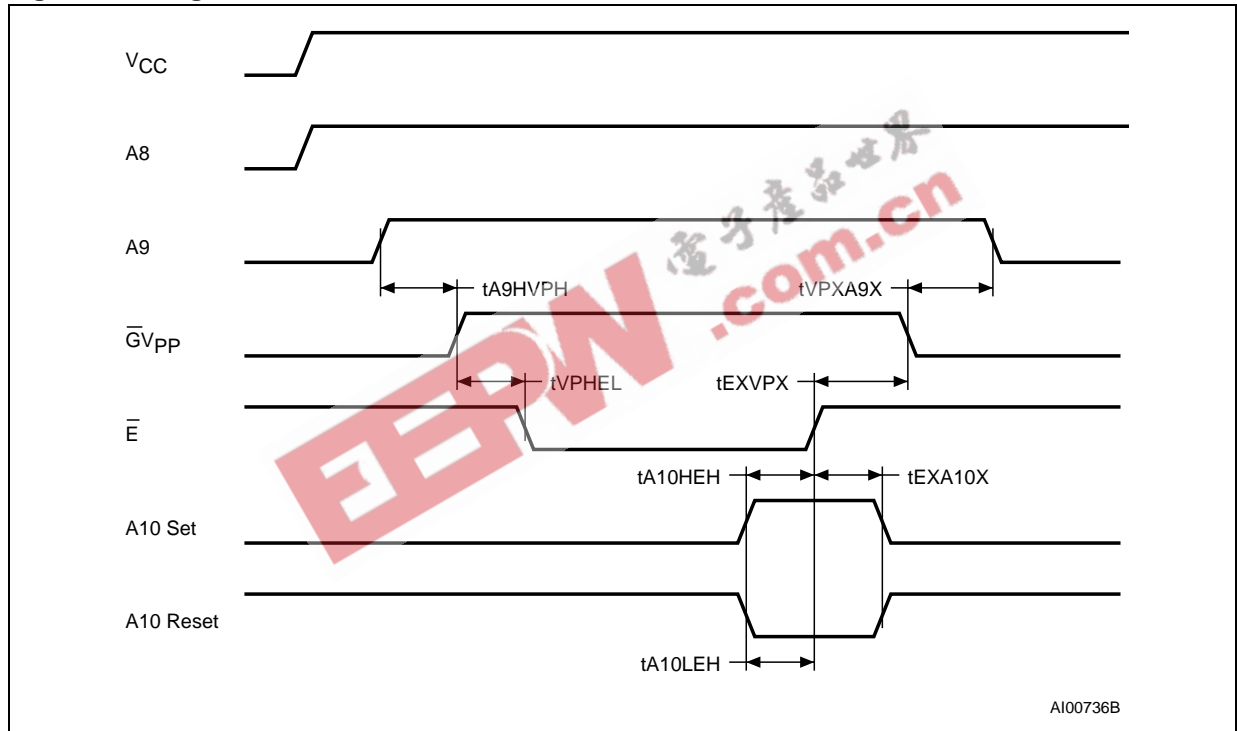

Note: $A8$ High level = 5V; $A9$ High level = 12V.

Table 12. Programming Mode AC Characteristics

Symbol	Alt	Parameter	Test Condition (1,2)	Min	Max	Unit
t_{AVEL}	t_{AS}	Address Valid to Chip Enable Low		2		μs
t_{QVEL}	t_{DS}	Input Valid to Chip Enable Low		2		μs
t_{VCHEL}	t_{VCS}	V_{CC} High to Chip Enable Low		2		μs
t_{VPHEL}	t_{OES}	V_{PP} High to Chip Enable Low		2		μs
t_{VPLVPH}	t_{PRT}	V_{PP} Rise Time		50		ns
t_{ELEH}	t_{PW}	Chip Enable Program Pulse Width (Initial)		95	105	μs
t_{EHQX}	t_{DH}	Chip Enable High to Input Transition		2		μs
t_{EHVPX}	t_{OEH}	Chip Enable High to V_{PP} Transition		2		μs
t_{VPLEL}	t_{VR}	V_{PP} Low to Chip Enable Low		2		μs
t_{ELQV}	t_{DV}	Chip Enable Low to Output Valid			1	μs
$t_{EHQZ}^{(3)}$	t_{DFP}	Chip Enable High to Output Hi-Z		0	130	ns
t_{EHAX}	t_{AH}	Chip Enable High to Address Transition		0		ns

Note: 1. $T_A = 25\text{ }^\circ\text{C}$; $V_{CC} = 6.25\text{V} \pm 0.25\text{V}$; $V_{PP} = 12.75\text{V} \pm 0.25\text{V}$

2. V_{CC} must be applied simultaneously with or before V_{PP} and removed simultaneously or after V_{PP} .

3. Sampled only, not 100% tested.

Figure 11. Programming and Verify Modes AC Waveforms



AI00737

PACKAGE MECHANICAL

Figure 12. FDIP28W - 28 pin Ceramic Frit-seal DIP, with window, Package Outline



Note: Drawing is not to scale.

Table 13. FDIP28W - 28 pin Ceramic Frit-seal DIP, with window, Package Mechanical Data

Symbol	millimeters			inches		
	Typ	Min	Max	Typ	Min	Max
A			5.72			0.225
A1		0.51	1.40		0.020	0.055
A2		3.91	4.57		0.154	0.180
A3		3.89	4.50		0.153	0.177
B		0.41	0.56		0.016	0.022
B1	1.45	-	-	0.057	-	-
C		0.23	0.30		0.009	0.012
D		36.50	37.34		1.437	1.470
D2	33.02	-	-	1.300	-	-
E	15.24	-	-	0.600	-	-
E1		13.06	13.36		0.514	0.526
e	2.54	-	-	0.100	-	-
eA	14.99	-	-	0.590	-	-
eB		16.18	18.03		0.637	0.710
L		3.18	4.10		0.125	0.161
S		1.52	2.49		0.060	0.098
Ø	7.11	-	-	0.280	-	-
α		4°	11°		4°	11°
N		28			28	

Figure 13. PDIP28 - 28 pin Plastic DIP, 600 mils width, Package Outline

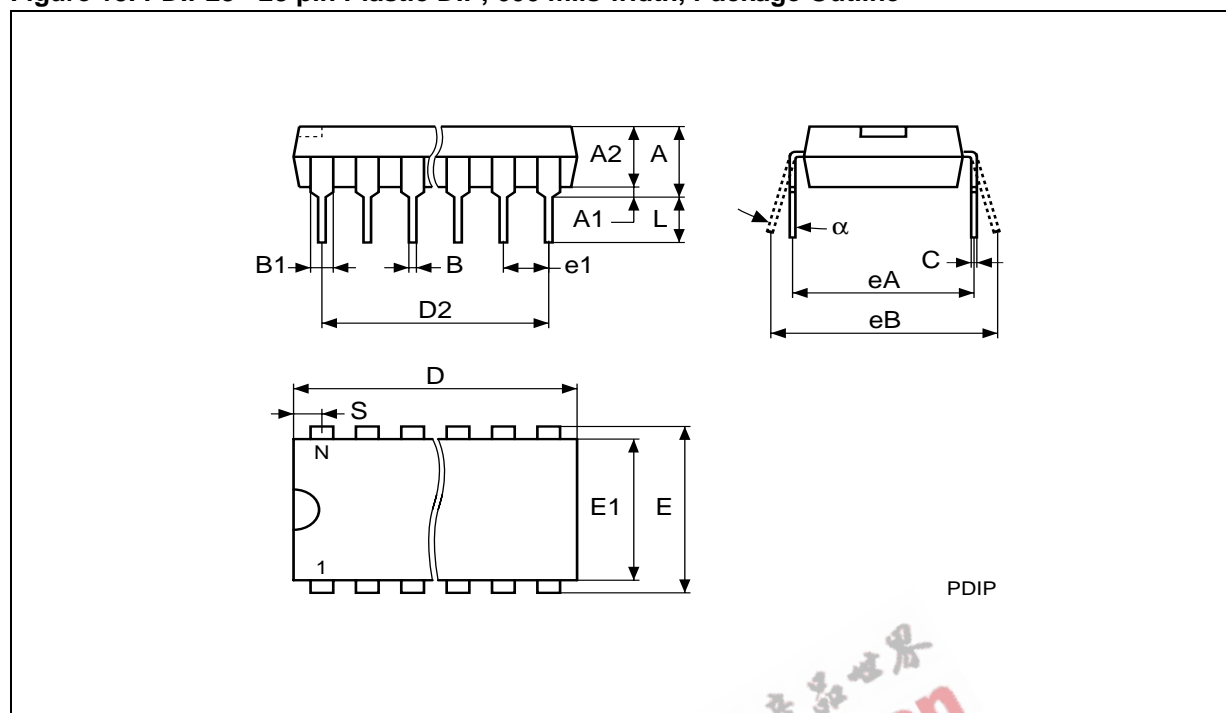

Note: Drawing is not to scale.

Table 14. PDIP28 - 28 pin Plastic DIP, 600 mils width, Package Mechanical Data

Symbol	millimeters			inches		
	Typ	Min	Max	Typ	Min	Max
A	4.445			0.1750		
A1	0.630			0.0248		
A2	3.810	3.050	4.570	0.1500	0.1201	0.1799
B	0.450			0.0177		
B1	1.270			0.0500		
C		0.230	0.310		0.0091	0.0122
D	36.830	36.580	37.080	1.4500	1.4402	1.4598
D2	33.020	–	–	1.3000	–	–
E	15.240			0.6000		
E1	13.720	12.700	14.480	0.5402	0.5000	0.5701
e1	2.540	–	–	0.1000	–	–
eA	15.000	14.800	15.200	0.5906	0.5827	0.5984
eB		15.200	16.680		0.5984	0.6567
L	3.300			0.1299		
S		1.78	2.08		0.070	0.082
alpha		0°	10°		0°	10°
N		28			28	

Figure 14. PLCC32 - 32 lead Plastic Leaded Chip Carrier, Package Outline



Note: Drawing is not to scale.

Table 15. PLCC32 - 32 lead Plastic Leaded Chip Carrier, Package Mechanical Data

Symbol	millimeters			inches		
	Typ	Min	Max	Typ	Min	Max
A		3.18	3.56		0.125	0.140
A1		1.53	2.41		0.060	0.095
A2		0.38	-		0.015	-
B		0.33	0.53		0.013	0.021
B1		0.66	0.81		0.026	0.032
CP			0.10			0.004
D		12.32	12.57		0.485	0.495
D1		11.35	11.51		0.447	0.453
D2		4.78	5.66		0.188	0.223
D3	7.62	-	-	0.300	-	-
E		14.86	15.11		0.585	0.595
E1		13.89	14.05		0.547	0.553
E2		6.05	6.93		0.238	0.273
E3	10.16	-	-	0.400	-	-
e	1.27	-	-	0.050	-	-
F		0.00	0.13		0.000	0.005
R	0.89	-	-	0.035	-	-
N		32			32	

Figure 15. TSOP28 - 28 lead Plastic Thin Small Outline, 8 x 13.4 mm, Package Outline



Note: Drawing is not to scale

Table 16. TSOP28 - 28 lead Plastic Thin Small Outline, 8 x 13.4 mm, Package Mechanical Data

Symbol	Typ	millimeters		Typ	inches	
		Min	Max		Min	Max
A			1.250			0.0492
A1			0.200			0.0079
A2		0.950	1.150		0.0374	0.0453
B		0.170	0.270		0.0067	0.0106
C		0.100	0.210		0.0039	0.0083
CP			0.100			0.0039
D		13.200	13.600		0.5197	0.5354
D1		11.700	11.900		0.4606	0.4685
e	0.550	–	–	0.0217	–	–
E		7.900	8.100		0.3110	0.3189
L		0.500	0.700		0.0197	0.0276
α		0°	5°		0°	5°
N		28			28	

PART NUMBERING

Table 17. Ordering Information Scheme

Example:	M27C512	-70	X	C	1	TR
Device Type M27						
Supply Voltage C = 5V						
Device Function 512 = 512 Kbit (64Kb x8)						
Speed -45 ⁽¹⁾ = 45 ns -60 = 60 ns -70 = 70 ns -80 = 80 ns -90 = 90 ns -10 = 100 ns -12 = 120 ns -15 = 150 ns -20 = 200 ns -25 = 250 ns						
V_{CC} Tolerance blank = ± 10% X = ± 5%						
Package F = FDIP28W B = PDIP28 C = PLCC32 N = TSOP28: 8 x 13.4 mm						
Temperature Range 1 = 0 to 70 °C 3 = -40 to 125 °C 6 = -40 to 85 °C						
Options Blank = Standard Packing TR = Tape and Reel Packing E = Lead-free and RoHS Package, Standard Packing F = Lead-free and RoHS Package, Tape and Reel Packing						

Note: 1. High Speed, see AC Characteristics section for further information.

For a list of available options (speed, package, etc.) or for further information on any aspect of this device, please contact your nearest ST Sales Office.

REVISION HISTORY

Table 18. Revision History

Date	Version	Revision Details
November 1998	1.0	First Issue
25-Sep-2000	1.1	AN620 Reference removed
02-Apr-2001	1.2	FDIP28W mechanical dimensions changed (Table 13.)
29-Aug-2002	1.3	Package mechanical data clarified for PDIP28 (Table 14.), PLCC32 (Table 15. , Figure 14.) and TSOP28 (Table 16. , Figure 15.)
08-Nov-2004	2.0	Details of ECOPACK lead-free package options added. Additional Burn-in option removed

EEPW 电子产品世界
.com.cn

EEPW 电子产品世界
.com.cn

Information furnished is believed to be accurate and reliable. However, STMicroelectronics assumes no responsibility for the consequences of use of such information nor for any infringement of patents or other rights of third parties which may result from its use. No license is granted by implication or otherwise under any patent or patent rights of STMicroelectronics. Specifications mentioned in this publication are subject to change without notice. This publication supersedes and replaces all information previously supplied. STMicroelectronics products are not authorized for use as critical components in life support devices or systems without express written approval of STMicroelectronics.

The ST logo is a registered trademark of STMicroelectronics.

All other names are the property of their respective owners

© 2004 STMicroelectronics - All rights reserved

STMicroelectronics group of companies

Australia - Belgium - Brazil - Canada - China - Czech Republic - Finland - France - Germany - Hong Kong - India - Israel - Italy - Japan - Malaysia - Malta - Morocco - Singapore - Spain - Sweden - Switzerland - United Kingdom - United States of America

www.st.com