

# MC14069UB

## Hex Inverter

The MC14069UB hex inverter is constructed with MOS P-channel and N-channel enhancement mode devices in a single monolithic structure. These inverters find primary use where low power dissipation and/or high noise immunity is desired. Each of the six inverters is a single stage to minimize propagation delays.

- Supply Voltage Range = 3.0 Vdc to 18 Vdc
- Capable of Driving Two Low-Power TTL Loads or One Low-Power Schottky TTL Load Over the Rated Temperature Range
- Triple Diode Protection on All Inputs
- Pin-for-Pin Replacement for CD4069UB
- Meets JEDEC UB Specifications

### MAXIMUM RATINGS (Voltages Referenced to $V_{SS}$ ) (Note 2.)

Symbol	Parameter	Value	Unit
$V_{DD}$	DC Supply Voltage Range	-0.5 to +18.0	V
$V_{in}, V_{out}$	Input or Output Voltage Range (DC or Transient)	-0.5 to $V_{DD} + 0.5$	V
$I_{in}, I_{out}$	Input or Output Current (DC or Transient) per Pin	$\pm 10$	mA
$P_D$	Power Dissipation, per Package (Note 3.)	500	mW
$T_A$	Ambient Temperature Range	-55 to +125	$^{\circ}C$
$T_{stg}$	Storage Temperature Range	-65 to +150	$^{\circ}C$
$T_L$	Lead Temperature (8-Second Soldering)	260	$^{\circ}C$

2. Maximum Ratings are those values beyond which damage to the device may occur.
3. Temperature Derating:  
Plastic "P and D/DW" Packages: - 7.0 mW/ $^{\circ}C$  From 65 $^{\circ}C$  To 125 $^{\circ}C$

This device contains protection circuitry to guard against damage due to high static voltages or electric fields. However, precautions must be taken to avoid applications of any voltage higher than maximum rated voltages to this high-impedance circuit. For proper operation,  $V_{in}$  and  $V_{out}$  should be constrained to the range  $V_{SS} \leq (V_{in} \text{ or } V_{out}) \leq V_{DD}$ .

Unused inputs must always be tied to an appropriate logic voltage level (e.g., either  $V_{SS}$  or  $V_{DD}$ ). Unused outputs must be left open.



**ON Semiconductor**

<http://onsemi.com>

### MARKING DIAGRAMS

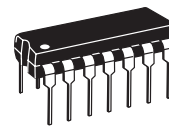

**PDIP-14**  
**P SUFFIX**  
**CASE 646**

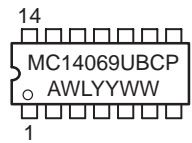

**SOIC-14**  
**D SUFFIX**  
**CASE 751A**

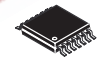
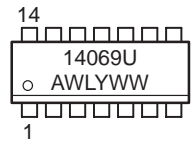

**TSSOP-14**  
**DT SUFFIX**  
**CASE 948G**

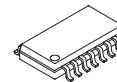
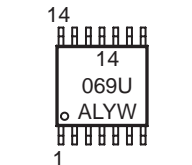

**SOEIAJ-14**  
**F SUFFIX**  
**CASE 965**

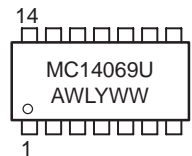

A = Assembly Location  
WL or L = Wafer Lot  
YY or Y = Year  
WW or W = Work Week

### ORDERING INFORMATION

Device	Package	Shipping
MC14069UBCP	PDIP-14	2000/Box
MC14069UBD	SOIC-14	2750/Box
MC14069UBDR2	SOIC-14	2500/Tape & Reel
MC14069UBDT	TSSOP-14	96/Rail
MC14069UBDTEL	TSSOP-14	2000/Tape & Reel
MC14069UBDTR2	TSSOP-14	2500/Tape & Reel
MC14069UBF	SOEIAJ-14	See Note 1.
MC14069UBFEL	SOEIAJ-14	See Note 1.

1. For ordering information on the EIAJ version of the SOIC packages, please contact your local ON Semiconductor representative.

# MC14069UB

## PIN ASSIGNMENT

IN 1	1	14	V <sub>DD</sub>
OUT 1	2	13	IN 6
IN 2	3	12	OUT 6
OUT 2	4	11	IN 5
IN 3	5	10	OUT 5
OUT 3	6	9	IN 4
V <sub>SS</sub>	7	8	OUT 4

## LOGIC DIAGRAM

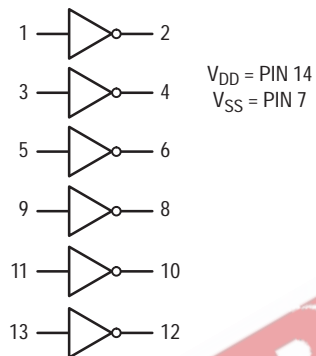

## CIRCUIT SCHEMATIC (1/6 OF CIRCUIT SHOWN)

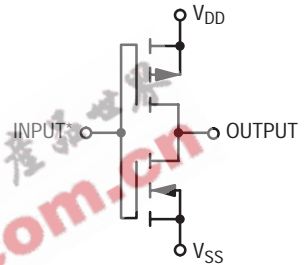

\*Double diode protection on all inputs not shown.

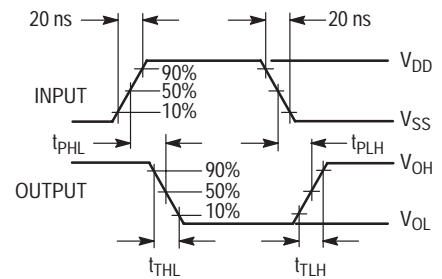
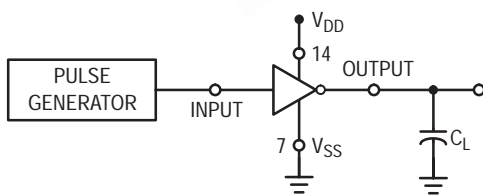

Figure 1. Switching Time Test Circuit and Waveforms

# MC14069UB

## ELECTRICAL CHARACTERISTICS (Voltages Referenced to $V_{SS}$ )

Characteristic	Symbol	$V_{DD}$ Vdc	-55°C		25°C			125°C		Unit
			Min	Max	Min	Typ (4.)	Max	Min	Max	
Output Voltage $V_{in} = V_{DD}$  $V_{in} = 0$	"0" Level $V_{OL}$	5.0	—	0.05	—	0	0.05	—	0.05	Vdc
		10	—	0.05	—	0	0.05	—	0.05	
		15	—	0.05	—	0	0.05	—	0.05	
	"1" Level $V_{OH}$	5.0	4.95	—	4.95	5.0	—	4.95	—	Vdc
		10	9.95	—	9.95	10	—	9.95	—	
		15	14.95	—	14.95	15	—	14.95	—	
Input Voltage $(V_O = 4.5 \text{ Vdc})$ $(V_O = 9.0 \text{ Vdc})$ $(V_O = 13.5 \text{ Vdc})$  $(V_O = 0.5 \text{ Vdc})$ $(V_O = 1.0 \text{ Vdc})$ $(V_O = 1.5 \text{ Vdc})$	"0" Level $V_{IL}$	5.0	—	1.0	—	2.25	1.0	—	1.0	Vdc
		10	—	2.0	—	4.50	2.0	—	2.0	
		15	—	2.5	—	6.75	2.5	—	2.5	
	"1" Level $V_{IH}$	5.0	4.0	—	4.0	2.75	—	4.0	—	Vdc
		10	8.0	—	8.0	5.50	—	8.0	—	
		15	12.5	—	12.5	8.25	—	12.5	—	
Output Drive Current $(V_{OH} = 2.5 \text{ Vdc})$ $(V_{OH} = 4.6 \text{ Vdc})$ $(V_{OH} = 9.5 \text{ Vdc})$ $(V_{OH} = 13.5 \text{ Vdc})$  $(V_{OL} = 0.4 \text{ Vdc})$ $(V_{OL} = 0.5 \text{ Vdc})$ $(V_{OL} = 1.5 \text{ Vdc})$	Source $I_{OH}$	5.0	-3.0	—	-2.4	-4.2	—	-1.7	—	mAdc
		5.0	-0.64	—	-0.51	-0.88	—	-0.36	—	
		10	-1.6	—	-1.3	-2.25	—	-0.9	—	
	Sink $I_{OL}$	5.0	0.64	—	0.51	0.88	—	0.36	—	mAdc
		10	1.6	—	1.3	2.25	—	0.9	—	
		15	4.2	—	3.4	8.8	—	2.4	—	
Input Current	$I_{in}$	15	—	$\pm 0.1$	—	$\pm 0.00001$	$\pm 0.1$	—	$\pm 1.0$	$\mu\text{Adc}$
Input Capacitance $(V_{in} = 0)$	$C_{in}$	—	—	—	—	5.0	7.5	—	—	pF
Quiescent Current (Per Package)	$I_{DD}$	5.0	—	0.25	—	0.0005	0.25	—	7.5	$\mu\text{Adc}$
		10	—	0.5	—	0.0010	0.5	—	15	
		15	—	1.0	—	0.0015	1.0	—	30	
Total Supply Current (5.) (6.) (Dynamic plus Quiescent, Per Gate) ( $C_L = 50 \text{ pF}$ )	$I_T$	5.0	$I_T = (0.3 \mu\text{A/kHz}) f + I_{DD}/6$							$\mu\text{Adc}$
		10	$I_T = (0.6 \mu\text{A/kHz}) f + I_{DD}/6$							
		15	$I_T = (0.9 \mu\text{A/kHz}) f + I_{DD}/6$							
Output Rise and Fall Times (5.) $(C_L = 50 \text{ pF})$ $t_{TLH}, t_{THL} = (1.35 \text{ ns/pF}) C_L + 33 \text{ ns}$ $t_{TLH}, t_{THL} = (0.60 \text{ ns/pF}) C_L + 20 \text{ ns}$ $t_{TLH}, t_{THL} = (0.40 \text{ ns/pF}) C_L + 20 \text{ ns}$	$t_{TLH},$ $t_{THL}$	5.0	—	—	—	100	200	—	—	ns
		10	—	—	—	50	100	—	—	
		10	—	—	—	40	80	—	—	
		15	—	—	—	40	80	—	—	
Propagation Delay Times (5.) $(C_L = 50 \text{ pF})$ $t_{PLH}, t_{PHL} = (0.90 \text{ ns/pF}) C_L + 20 \text{ ns}$ $t_{PLH}, t_{PHL} = (0.36 \text{ ns/pF}) C_L + 22 \text{ ns}$ $t_{PLH}, t_{PHL} = (0.26 \text{ ns/pF}) C_L + 17 \text{ ns}$	$t_{PLH},$ $t_{PHL}$	5.0	—	—	—	65	125	—	—	ns
		10	—	—	—	40	75	—	—	
		10	—	—	—	40	75	—	—	
		15	—	—	—	30	55	—	—	

4. Data labelled "Typ" is not to be used for design purposes but is intended as an indication of the IC's potential performance.

5. The formulas given are for the typical characteristics only at 25°C.

6. To calculate total supply current at loads other than 50 pF:

$$I_T(C_L) = I_T(50 \text{ pF}) + (C_L - 50) V f k$$

where:  $I_T$  is in  $\mu\text{A}$  (per package),  $C_L$  in pF,  $V = (V_{DD} - V_{SS})$  in volts,  $f$  in kHz is input frequency, and  $k = 0.002$ .

# MC14069UB

## PACKAGE DIMENSIONS

**P SUFFIX**  
**PLASTIC DIP PACKAGE**  
**CASE 646-06**  
**ISSUE M**

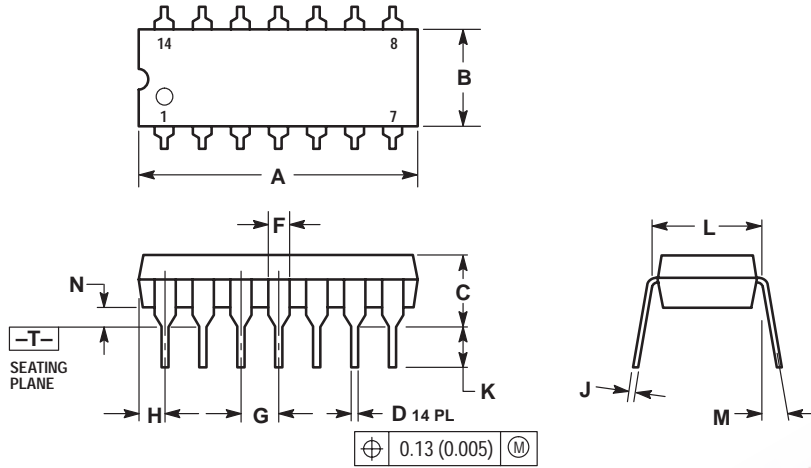

- NOTES:
1. DIMENSIONING AND TOLERANCING PER ANSI Y14.5M, 1982.
  2. CONTROLLING DIMENSION: INCH.
  3. DIMENSION L TO CENTER OF LEADS WHEN FORMED PARALLEL.
  4. DIMENSION B DOES NOT INCLUDE MOLD FLASH.
  5. ROUNDED CORNERS OPTIONAL.

DIM	INCHES		MILLIMETERS	
	MIN	MAX	MIN	MAX
A	0.715	0.770	18.16	18.80
B	0.240	0.260	6.10	6.60
C	0.145	0.185	3.69	4.69
D	0.015	0.021	0.38	0.53
F	0.040	0.070	1.02	1.78
G	0.100 BSC		2.54 BSC	
H	0.052	0.095	1.32	2.41
J	0.008	0.015	0.20	0.38
K	0.115	0.135	2.92	3.43
L	0.290	0.310	7.37	7.87
M	---	10°	---	10°
N	0.015	0.039	0.38	1.01

EPW.com.cn 电子产品世界

# MC14069UB

## PACKAGE DIMENSIONS

**D SUFFIX**  
 PLASTIC SOIC PACKAGE  
 CASE 751A-03  
 ISSUE F

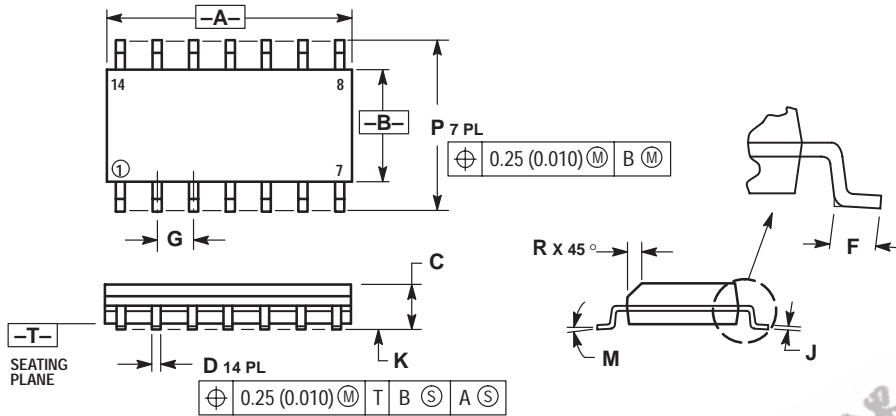

**NOTES:**

1. DIMENSIONING AND TOLERANCING PER ANSI Y14.5M, 1982.
2. CONTROLLING DIMENSION: MILLIMETER.
3. DIMENSIONS A AND B DO NOT INCLUDE MOLD PROTRUSION.
4. MAXIMUM MOLD PROTRUSION 0.15 (0.006) PER SIDE.
5. DIMENSION D DOES NOT INCLUDE DAMBAR PROTRUSION. ALLOWABLE DAMBAR PROTRUSION SHALL BE 0.127 (0.005) TOTAL IN EXCESS OF THE D DIMENSION AT MAXIMUM MATERIAL CONDITION.

DIM	MILLIMETERS		INCHES	
	MIN	MAX	MIN	MAX
A	8.55	8.75	0.337	0.344
B	3.80	4.00	0.150	0.157
C	1.35	1.75	0.054	0.068
D	0.35	0.49	0.014	0.019
F	0.40	1.25	0.016	0.049
G	1.27 BSC		0.050 BSC	
J	0.19	0.25	0.008	0.009
K	0.10	0.25	0.004	0.009
M	0°	7°	0°	7°
P	5.80	6.20	0.228	0.244
R	0.25	0.50	0.010	0.019

EEPW.com.cn 电子产品世界

# MC14069UB

## PACKAGE DIMENSIONS

DT SUFFIX  
 PLASTIC TSSOP PACKAGE  
 CASE 948G-01  
 ISSUE O

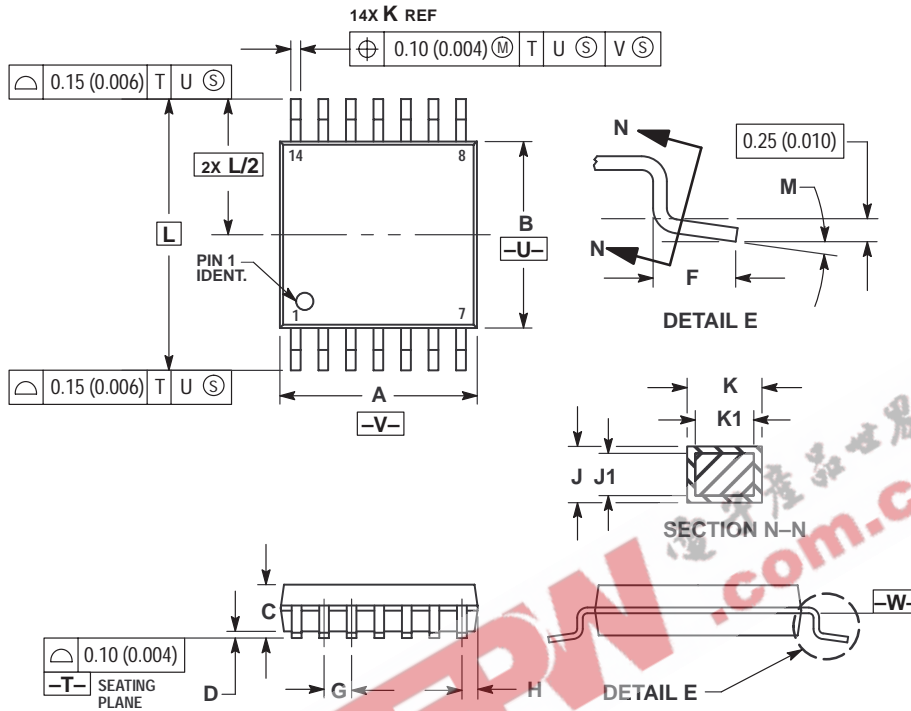

### NOTES:

1. DIMENSIONING AND TOLERANCING PER ANSI Y14.5M, 1982.
2. CONTROLLING DIMENSION: MILLIMETER.
3. DIMENSION A DOES NOT INCLUDE MOLD FLASH, PROTRUSIONS OR GATE BURRS. MOLD FLASH OR GATE BURRS SHALL NOT EXCEED 0.15 (0.006) PER SIDE.
4. DIMENSION B DOES NOT INCLUDE INTERLEAD FLASH OR PROTRUSION. INTERLEAD FLASH OR PROTRUSION SHALL NOT EXCEED 0.25 (0.010) PER SIDE.
5. DIMENSION K DOES NOT INCLUDE DAMBAR PROTRUSION. ALLOWABLE DAMBAR PROTRUSION SHALL BE 0.08 (0.003) TOTAL IN EXCESS OF THE K DIMENSION AT MAXIMUM MATERIAL CONDITION.
6. TERMINAL NUMBERS ARE SHOWN FOR REFERENCE ONLY.
7. DIMENSION A AND B ARE TO BE DETERMINED AT DATUM PLANE -W-

DIM	MILLIMETERS		INCHES	
	MIN	MAX	MIN	MAX
A	4.90	5.10	0.193	0.200
B	4.30	4.50	0.169	0.177
C	---	1.20	---	0.047
D	0.05	0.15	0.002	0.006
F	0.50	0.75	0.020	0.030
G	0.65 BSC		0.026 BSC	
H	0.50	0.60	0.020	0.024
J	0.09	0.20	0.004	0.008
J1	0.09	0.16	0.004	0.006
K	0.19	0.30	0.007	0.012
K1	0.19	0.25	0.007	0.010
L	6.40 BSC		0.252 BSC	
M	0° - 8°		0° - 8°	

# MC14069UB

## PACKAGE DIMENSIONS

**F SUFFIX**  
 PLASTIC EIAJ SOIC PACKAGE  
 CASE 965-01  
 ISSUE O

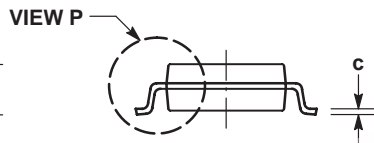
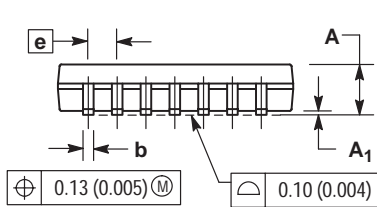
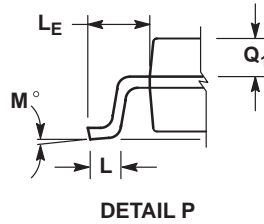
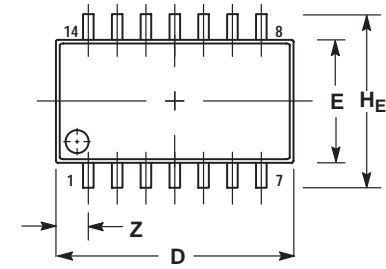

**NOTES:**

1. DIMENSIONING AND TOLERANCING PER ANSI Y14.5M, 1982.
2. CONTROLLING DIMENSION: MILLIMETER.
3. DIMENSIONS D AND E DO NOT INCLUDE MOLD FLASH OR PROTRUSIONS AND ARE MEASURED AT THE PARTING LINE. MOLD FLASH OR PROTRUSIONS SHALL NOT EXCEED 0.15 (0.006) PER SIDE.
4. TERMINAL NUMBERS ARE SHOWN FOR REFERENCE ONLY.
5. THE LEAD WIDTH DIMENSION (b) DOES NOT INCLUDE DAMBAR PROTRUSION. ALLOWABLE DAMBAR PROTRUSION SHALL BE 0.08 (0.003) TOTAL IN EXCESS OF THE LEAD WIDTH DIMENSION AT MAXIMUM MATERIAL CONDITION. DAMBAR CANNOT BE LOCATED ON THE LOWER RADIUS OR THE FOOT. MINIMUM SPACE BETWEEN PROTRUSIONS AND ADJACENT LEAD TO BE 0.46 (0.018).

DIM	MILLIMETERS		INCHES	
	MIN	MAX	MIN	MAX
A	---	2.05	---	0.081
A <sub>1</sub>	0.05	0.20	0.002	0.008
b	0.35	0.50	0.014	0.020
c	0.18	0.27	0.007	0.011
D	9.90	10.50	0.390	0.413
E	5.10	5.45	0.201	0.215
e	1.27 BSC		0.050 BSC	
H <sub>E</sub>	7.40	8.20	0.291	0.323
0.50	0.50	0.85	0.020	0.033
L <sub>E</sub>	1.10	1.50	0.043	0.059
M	0 °	10 °	0 °	10 °
Q <sub>1</sub>	0.70	0.90	0.028	0.035
Z	---	1.42	---	0.056

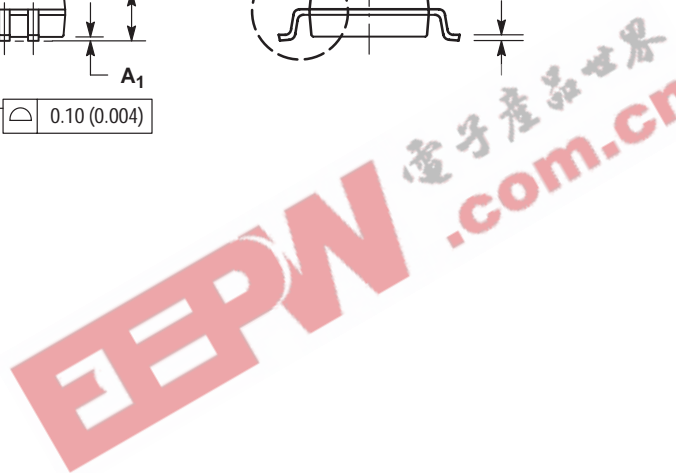

## MC14069UB

**ON Semiconductor** and  are trademarks of Semiconductor Components Industries, LLC (SCILLC). SCILLC reserves the right to make changes without further notice to any products herein. SCILLC makes no warranty, representation or guarantee regarding the suitability of its products for any particular purpose, nor does SCILLC assume any liability arising out of the application or use of any product or circuit, and specifically disclaims any and all liability, including without limitation special, consequential or incidental damages. "Typical" parameters which may be provided in SCILLC data sheets and/or specifications can and do vary in different applications and actual performance may vary over time. All operating parameters, including "Typicals" must be validated for each customer application by customer's technical experts. SCILLC does not convey any license under its patent rights nor the rights of others. SCILLC products are not designed, intended, or authorized for use as components in systems intended for surgical implant into the body, or other applications intended to support or sustain life, or for any other application in which the failure of the SCILLC product could create a situation where personal injury or death may occur. Should Buyer purchase or use SCILLC products for any such unintended or unauthorized application, Buyer shall indemnify and hold SCILLC and its officers, employees, subsidiaries, affiliates, and distributors harmless against all claims, costs, damages, and expenses, and reasonable attorney fees arising out of, directly or indirectly, any claim of personal injury or death associated with such unintended or unauthorized use, even if such claim alleges that SCILLC was negligent regarding the design or manufacture of the part. SCILLC is an Equal Opportunity/Affirmative Action Employer.

### PUBLICATION ORDERING INFORMATION

#### NORTH AMERICA Literature Fulfillment:

Literature Distribution Center for ON Semiconductor  
P.O. Box 5163, Denver, Colorado 80217 USA  
**Phone:** 303-675-2175 or 800-344-3860 Toll Free USA/Canada  
**Fax:** 303-675-2176 or 800-344-3867 Toll Free USA/Canada  
**Email:** ONlit@hibbertco.com  
Fax Response Line: 303-675-2167 or 800-344-3810 Toll Free USA/Canada

**N. American Technical Support:** 800-282-9855 Toll Free USA/Canada

#### EUROPE: LDC for ON Semiconductor – European Support

**German Phone:** (+1) 303-308-7140 (M-F 1:00pm to 5:00pm Munich Time)  
**Email:** ONlit-german@hibbertco.com  
**French Phone:** (+1) 303-308-7141 (M-F 1:00pm to 5:00pm Toulouse Time)  
**Email:** ONlit-french@hibbertco.com  
**English Phone:** (+1) 303-308-7142 (M-F 12:00pm to 5:00pm UK Time)  
**Email:** ONlit@hibbertco.com

#### EUROPEAN TOLL-FREE ACCESS\*: 00-800-4422-3781

\*Available from Germany, France, Italy, England, Ireland

#### CENTRAL/SOUTH AMERICA:

**Spanish Phone:** 303-308-7143 (Mon-Fri 8:00am to 5:00pm MST)  
**Email:** ONlit-spanish@hibbertco.com

#### ASIA/PACIFIC: LDC for ON Semiconductor – Asia Support

**Phone:** 303-675-2121 (Tue-Fri 9:00am to 1:00pm, Hong Kong Time)  
Toll Free from Hong Kong & Singapore:  
**001-800-4422-3781**  
**Email:** ONlit-asia@hibbertco.com

#### JAPAN: ON Semiconductor, Japan Customer Focus Center

4-32-1 Nishi-Gotanda, Shinagawa-ku, Tokyo, Japan 141-8549  
**Phone:** 81-3-5740-2745  
**Email:** r14525@onsemi.com

**ON Semiconductor Website:** <http://onsemi.com>

For additional information, please contact your local Sales Representative.