

**GENERAL PURPOSE  
DUAL JFET OPERATIONAL AMPLIFIERS**

- LOW POWER CONSUMPTION
- WIDE COMMON-MODE (UP TO  $V_{CC}^+$ ) AND DIFFERENTIAL VOLTAGE RANGE
- LOW INPUT BIAS AND OFFSET CURRENT
- OUTPUT SHORT-CIRCUIT PROTECTION
- HIGH INPUT IMPEDANCE J-FET INPUT STAGE
- INTERNAL FREQUENCY COMPENSATION
- LATCH UP FREE OPERATION
- HIGH SLEW RATE :  $16V/\mu s$  (typ)

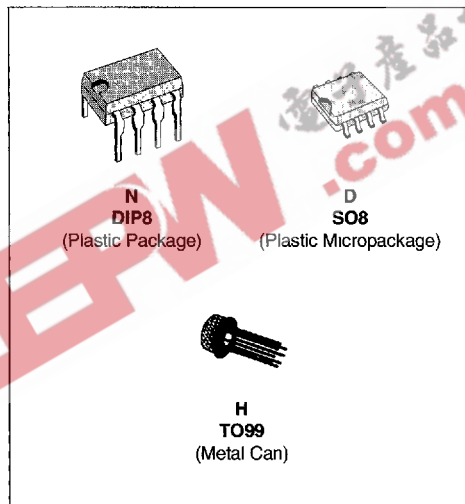

**DESCRIPTION**

These circuits are high speed J-FET input dual operational amplifiers incorporating well matched, high voltage J-FET and bipolar transistors in a monolithic integrated circuit.

The devices feature high slew rates, low input bias and offset current, and low offset voltage temperature coefficient.

**ORDER CODES**

| Part Number | Temperature   | Package |   |   |
|-------------|---------------|---------|---|---|
|             |               | H       | N | D |
| MC34002/A/B | 0°C, +70°C    | •       | • | • |
| MC33002/A/B | -40°C, +105°C | •       | • | • |
| MC35002/A/B | -55°C, +125°C | •       | • | • |

33002-01 TBL

**PIN CONNECTIONS (top views)**

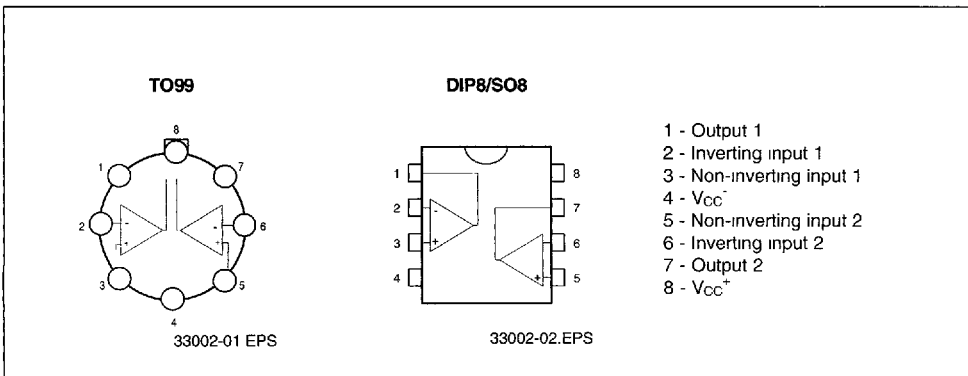

MC33002/A/B - MC34002/A/B - MC35002/A/B

SCHEMATIC DIAGRAM

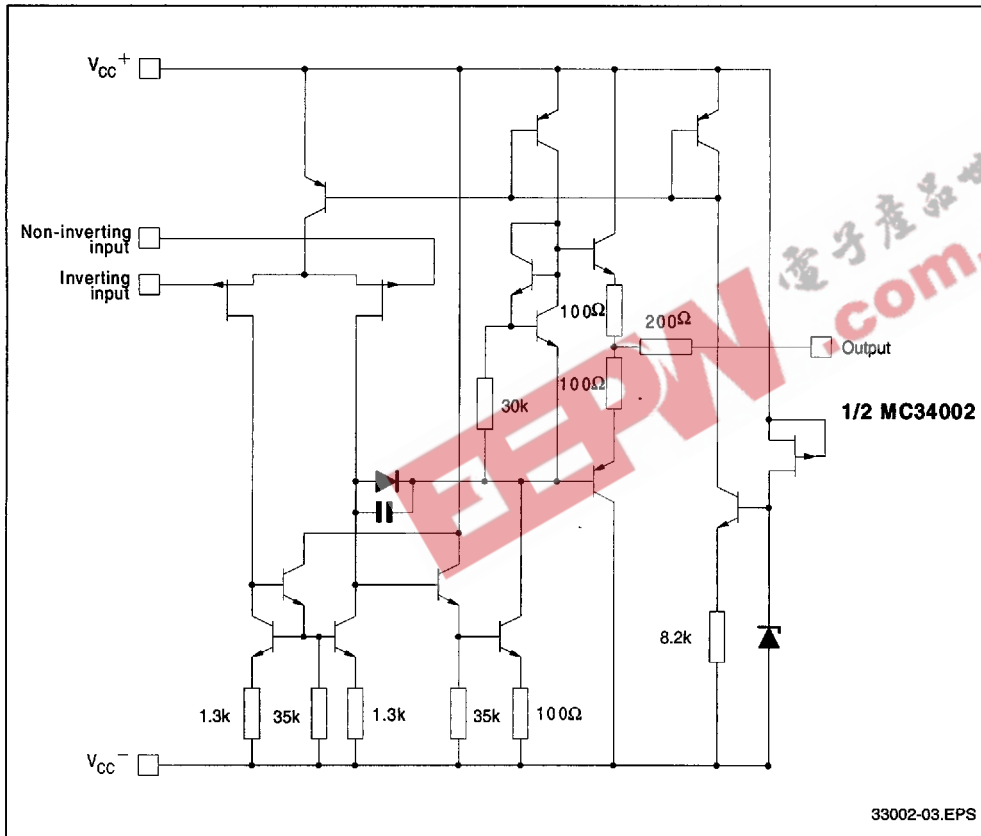

ABSOLUTE MAXIMUM RATINGS

| Symbol     | Parameter                              | Value   | Unit                                |             |
|------------|--|---|-------------------------------------|-------------|
| $V_{CC}$   | Supply Voltage - (note 1)              | $\pm 18$  | V                                   |             |
| $V_i$      | Input Voltage - (note 3)               | $\pm 15$  | V                                   |             |
| $V_{id}$   | Differential Input Voltage - (note 2)  | $\pm 30$  | V                                   |             |
| $P_{tot}$  | Power Dissipation                      | 680   | mW                                  |             |
|            | Output Short-circuit Duration (note 4) | Infinite  |                                     |             |
| $T_{oper}$ | Operating Free Air Temperature Range   | MC34002, A, B<br>MC33002, A, B<br>MC35002, A, B | 0 to 70<br>-40 to 105<br>-55 to 125 | $^{\circ}C$ |
| $T_{stg}$  | Storage Temperature Range              |   | -65 to 150                          | $^{\circ}C$ |

- Notes :
- 1 All voltage values, except differential voltage, are with respect to the zero reference level (ground) of the supply voltages where the zero reference level is the midpoint between  $V_{CC}^+$  and  $V_{CC}^-$ .
  - 2 Differential voltages are at the non-inverting input terminal with respect to the inverting input terminal.
  - 3 The magnitude of the input voltage must never exceed the magnitude of the supply voltage or 15 volts, whichever is less.
  - 4 The output may be shorted to ground or to either supply. Temperature and /or supply voltages must be limited to ensure that the dissipation rating is not exceeded.

**MC33002/A/B - MC34002/A/B - MC35002/A/B**

**ELECTRICAL CHARACTERISTICS**

V<sub>CC</sub> = ±15V, T<sub>amb</sub> = 25°C (unless otherwise specified)

| Symbol                           | Parameter   | MC35002A,B<br>MC33002A,B<br>MC34002A,B |            |                  | MC35002<br>MC33002<br>MC34002 |                   |      | Unit                   |
|----------------------------------|---|--|------------|------------------|-------------------------------|-------------------|------|------------------------|
|                                  |   | Min.                                   | Typ.       | Max.             | Min.                          | Typ.              | Max. |                        |
| V <sub>io</sub>                  | Input Offset Voltage (R <sub>S</sub> ≤ 10kΩ)<br>T <sub>amb</sub> = 25°C<br>MC35002B, MC34002B, MC33002B<br>MC35002A, MC34002A, MC33002A<br>T <sub>min</sub> ≤ T <sub>amb</sub> ≤ T <sub>max</sub><br>MC35002B, MC34002B, MC33002B<br>MC35002A, MC34002A, MC33002A |  | 3<br>1     | 5<br>2           |                               | 3<br>13           | 10   | mV                     |
| DV <sub>io</sub>                 | Input Offset Voltage Drift  |  | 10         |                  | 10                            |                   |      | μV/°C                  |
| I <sub>io</sub>                  | Input Offset Current *<br>T <sub>amb</sub> = 25°C<br>T <sub>min</sub> ≤ T <sub>amb</sub> ≤ T <sub>max</sub>   |  | 5          | 50<br>4          | 5                             | 100<br>4          |      | pA<br>nA               |
| I <sub>ib</sub>                  | Input Bias Current *<br>T <sub>amb</sub> = 25°C<br>T <sub>min</sub> ≤ T <sub>amb</sub> ≤ T <sub>max</sub>   |  | 20         | 200<br>20        | 20                            | 200<br>20         |      | pA<br>nA               |
| A <sub>vd</sub>                  | Large Signal Voltage Gain (R <sub>L</sub> = 2kΩ, V <sub>O</sub> = ±10V)<br>T <sub>amb</sub> = 25°C<br>T <sub>min</sub> ≤ T <sub>amb</sub> ≤ T <sub>max</sub>  | 50<br>25                               | 200        |                  | 25<br>15                      | 200               |      | V/mV                   |
| SVR                              | Supply Voltage Rejection Ratio (R <sub>S</sub> ≤ 10kΩ)<br>T <sub>amb</sub> = 25°C<br>T <sub>min</sub> ≤ T <sub>amb</sub> ≤ T <sub>max</sub>   | 80<br>80                               | 86         |                  | 70<br>70                      | 86                |      | dB                     |
| I <sub>CC</sub>                  | Supply Current, per Amp, no Load<br>T <sub>amb</sub> = 25°C<br>T <sub>min</sub> ≤ T <sub>amb</sub> ≤ T <sub>max</sub>   |  | 1.4        | 2.5<br>2.8       |                               | 1.4<br>2.5<br>2.8 |      | mA                     |
| V <sub>icm</sub>                 | Input Common Mode Voltage Range   | ±11                                    | +15<br>-12 |                  | ±11                           | +15<br>-12        |      | V                      |
| CMR                              | Common Mode Rejection Ratio (R <sub>S</sub> ≤ 10kΩ)<br>T <sub>amb</sub> = 25°C<br>T <sub>min</sub> ≤ T <sub>amb</sub> ≤ T <sub>max</sub>  | 80<br>80                               | 86         |                  | 70<br>70                      | 86                |      | dB                     |
| I <sub>os</sub>                  | Output Short-circuit Current<br>T <sub>amb</sub> = 25°C<br>T <sub>min</sub> ≤ T <sub>amb</sub> ≤ T <sub>max</sub>   | 10<br>10                               | 40         | 60<br>60         | 10<br>10                      | 40<br>60          |      | mA                     |
| ±V <sub>OPP</sub>                | Output Voltage Swing<br>T <sub>amb</sub> = 25°C<br>T <sub>min</sub> ≤ T <sub>amb</sub> ≤ T <sub>max</sub>   |  |            |                  |                               |                   |      | V                      |
| SR                               | Slew Rate (V <sub>in</sub> = 10V, R <sub>L</sub> = 2kΩ, C <sub>L</sub> = 100pF,<br>T <sub>amb</sub> = 25°C, unity gain)   |  | 12         | 16               | 12                            | 16                |      | V/μs                   |
| t <sub>r</sub>                   | Rise Time (V <sub>in</sub> = 20mV, R <sub>L</sub> = 2kΩ, C <sub>L</sub> = 100pF,<br>T <sub>amb</sub> = 25°C, unity gain)  |  |            | 0.1              |                               | 0.1               |      | μs                     |
| K <sub>OV</sub>                  | Overshoot (V <sub>in</sub> = 20mV, R <sub>L</sub> = 2kΩ, C <sub>L</sub> = 100pF,<br>T <sub>amb</sub> = 25°C, unity gain)  |  |            | 10               |                               | 10                |      | %                      |
| GBP                              | Gain Bandwidth Product (f = 100kHz,<br>T <sub>amb</sub> = 25°C, V <sub>in</sub> = 10mV, R <sub>L</sub> = 2kΩ, C <sub>L</sub> = 100pF)   | 2.5                                    | 4          |                  | 2.5                           | 4                 |      | MHz                    |
| R <sub>i</sub>                   | Input Resistance  |  |            | 10 <sup>12</sup> |                               | 10 <sup>12</sup>  |      | Ω                      |
| THD                              | Total Harmonic Distortion (f = 1kHz, A <sub>V</sub> = 20dB,<br>R <sub>L</sub> = 2kΩ, C <sub>L</sub> = 100pF, T <sub>amb</sub> = 25°C, V <sub>O</sub> = 2V <sub>PP</sub> )   |  |            | 0.01             |                               | 0.01              |      | %                      |
| e <sub>n</sub>                   | Equivalent Input Noise Voltage<br>(f = 1kHz, R <sub>S</sub> = 100Ω)   |  |            | 15               |                               | 15                |      | $\frac{nV}{\sqrt{Hz}}$ |
| ∅ <sub>m</sub>                   | Phase Margin  |  |            | 45               |                               | 45                |      | Degrees                |
| V <sub>O1</sub> /V <sub>O2</sub> | Channel Separation (A <sub>vd</sub> = 100)  |  |            | 120              |                               | 120               |      | dB                     |

\* The input bias currents are junction leakage currents which approximately double for every 10°C increase in the junction temperature

33002-03.TBL

MC33002/A/B - MC34002/A/B - MC35002/A/B

MAXIMUM PEAK-TO-PEAK OUTPUT VOLTAGE VERSUS FREQUENCY

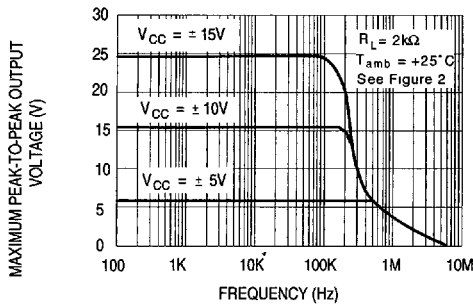

33002-04.EPS

MAXIMUM PEAK-TO-PEAK OUTPUT VOLTAGE VERSUS FREQUENCY

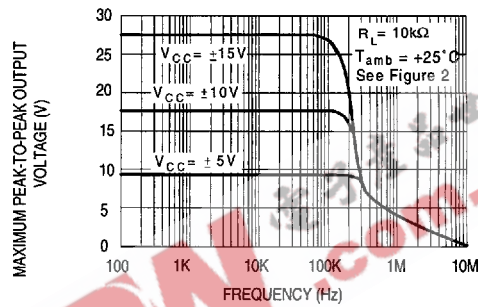

33002-05.EPS

MAXIMUM PEAK-TO-PEAK OUTPUT VOLTAGE VERSUS FREQUENCY

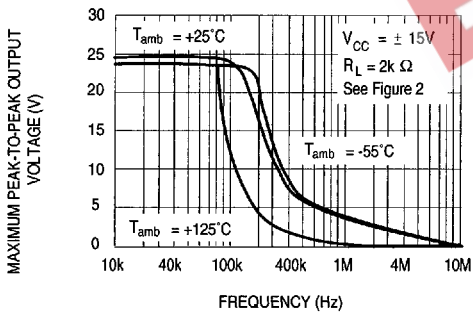

33002-06.EPS

MAXIMUM PEAK-TO-PEAK OUTPUT VOLTAGE VERSUS FREE AIR TEMP.

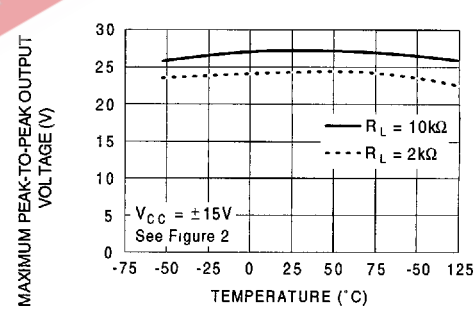

33002-07.EPS

MAXIMUM PEAK-TO-PEAK OUTPUT VOLTAGE VERSUS LOAD RESISTANCE

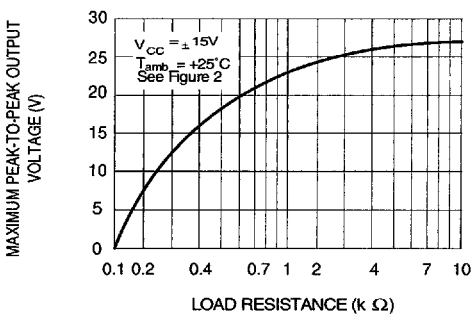

33002-08.EPS

MAXIMUM PEAK-TO-PEAK OUTPUT VOLTAGE VERSUS SUPPLY VOLTAGE

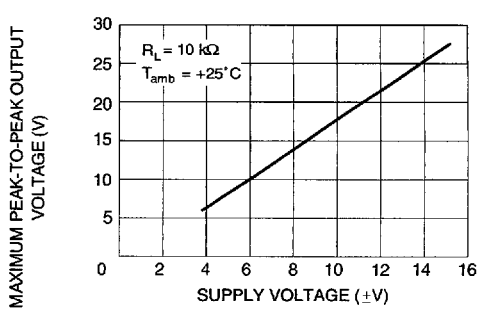

33002-09.EPS

MC33002/A/B - MC34002/A/B - MC35002/A/B

INPUT BIAS CURRENT VERSUS FREE AIR TEMPERATURE

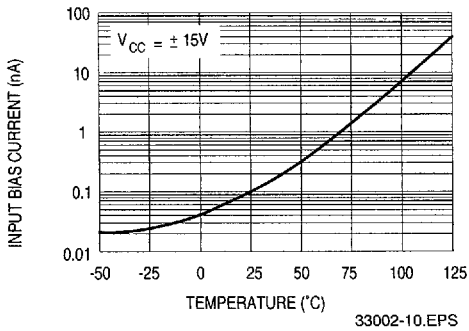

LARGE SIGNAL DIFFERENTIAL VOLTAGE AMPLIFICATION VERSUS FREE AIR TEMPERATURE

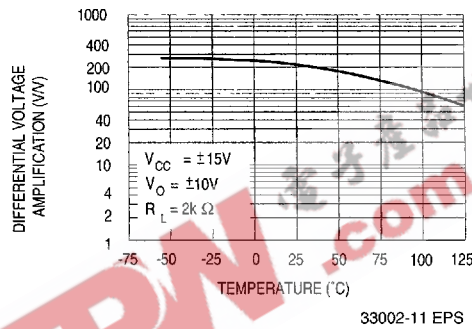

LARGE SIGNAL DIFFERENTIAL VOLTAGE AMPLIFICATION AND PHASE SHIFT VERSUS FREQUENCY

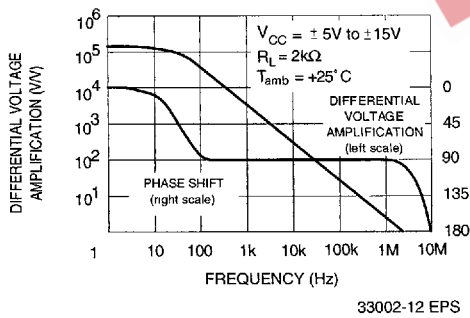

TOTAL POWER DISSIPATION VERSUS FREE AIR TEMPERATURE

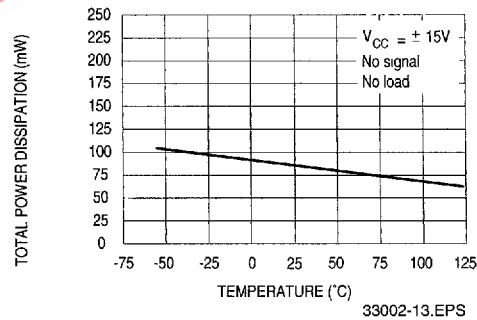

SUPPLY CURRENT PER AMPLIFIER VERSUS FREE AIR TEMPERATURE

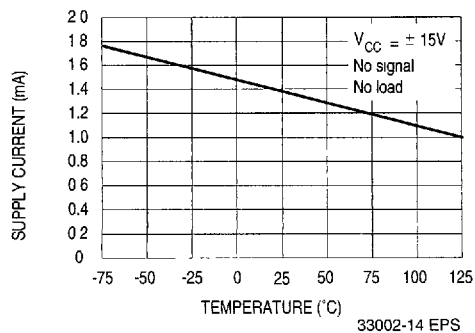

SUPPLY CURRENT PER AMPLIFIER VERSUS SUPPLY VOLTAGE

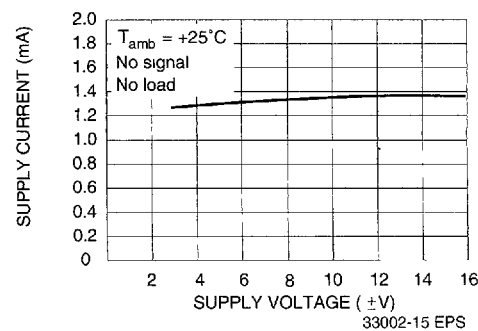

MC33002/A/B - MC34002/A/B - MC35002/A/B

COMMON MODE REJECTION RATIO  
VERSUS FREE AIR TEMPERATURE

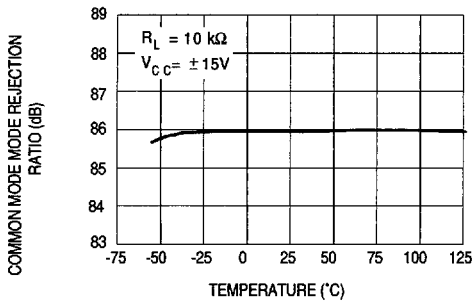

33002-16.EPS

VOLTAGE FOLLOWER LARGE SIGNAL  
PULSE RESPONSE

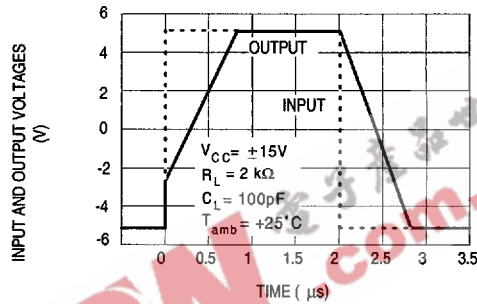

33002-17.EPS

OUTPUT VOLTAGE VERSUS  
ELAPSED TIME

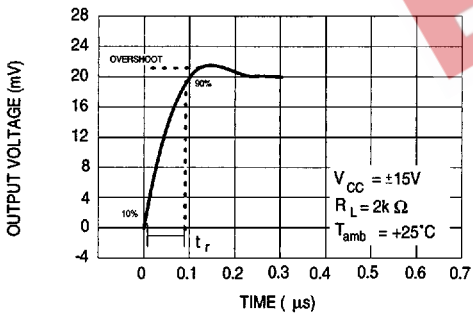

33002-18.EPS

EQUIVALENT INPUT NOISE VOLTAGE  
VERSUS FREQUENCY

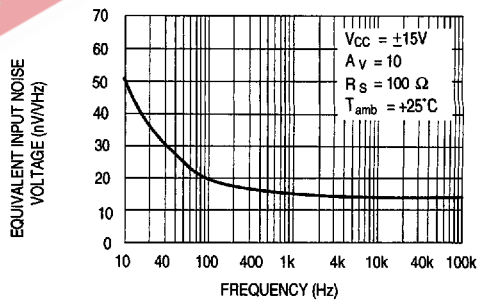

33002-19.EPS

TOTAL HARMONIC DISTORTION VERSUS  
FREQUENCY

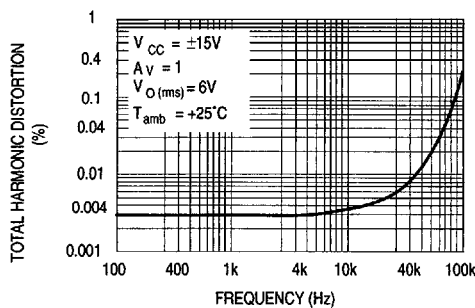

33002-20.EPS

PARAMETER MEASUREMENT INFORMATION

Figure 1 : Voltage Follower

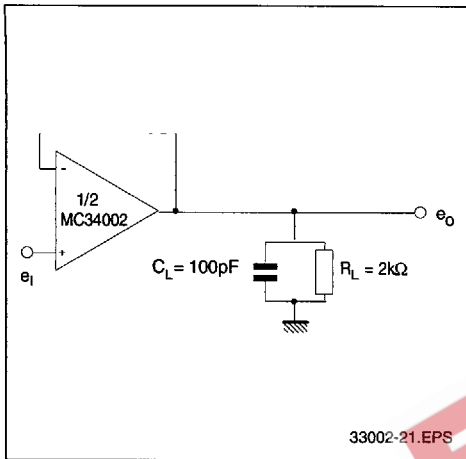
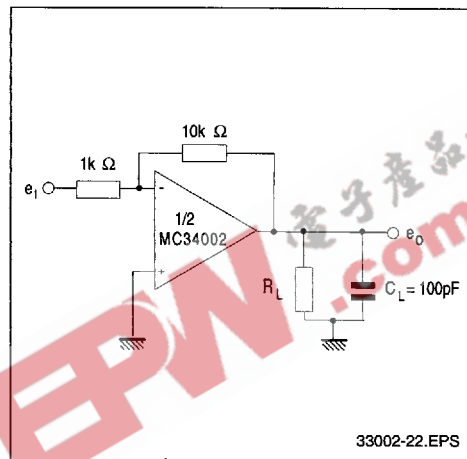

Figure 2 : Gain-of-10 Inverting Amplifier



TYPICAL APPLICATION

100KHz QUADRUPLE OSCILLATOR

