

FEATURES

- Dual-Supply Operation . . . $\pm 5\text{ V}$ to $\pm 18\text{ V}$
- Low Noise Voltage . . . $4.5\text{ nV}/\sqrt{\text{Hz}}$
- Low Input Offset Voltage . . . 0.15 mV
- Low Total Harmonic Distortion . . . 0.002%
- High Slew Rate . . . $7\text{ V}/\mu\text{s}$
- High-Gain Bandwidth Product . . . 16 MHz
- High Open-Loop AC Gain . . . 800 at 20 kHz
- Large Output-Voltage Swing . . . 14.1 V to -14.6 V
- Excellent Gain and Phase Margins

D (SOIC), DGK (MSOP), OR P (PDIP) PACKAGE
(TOP VIEW)

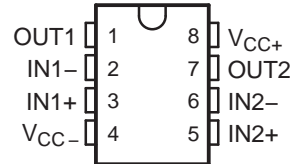

DESCRIPTION/ORDERING INFORMATION

The MC33078 is a bipolar dual operational amplifier with high-performance specifications for use in quality audio and data-signal applications. This device operates over a wide range of single- and dual-supply voltages and offers low noise, high-gain bandwidth, and high slew rate. Additional features include low total harmonic distortion, excellent phase and gain margins, large output voltage swing with no deadband crossover distortion, and symmetrical sink/source performance.

ORDERING INFORMATION

| T _A | PACKAGE ⁽¹⁾ | | ORDERABLE PART NUMBER | TOP-SIDE MARKING ⁽²⁾ |
|----------------|------------------------|--------------|-----------------------|---------------------------------|
| -40°C to 85°C | PDIP – P | Tube of 50 | MC33078P | MC33078P |
| | SOIC – D | Tube of 75 | MC33078D | M33078 |
| | | Reel of 2500 | MC33078DR | |
| | | Reel of 2500 | MC33078DGKR | |
| | VSSOP/MSOP – DGK | Reel of 250 | MC33078DGKT | MY_ |

(1) Package drawings, standard packing quantities, thermal data, symbolization, and PCB design guidelines are available at www.ti.com/sc/package.

(2) DGK: The actual top-side marking has one additional character that designates the assembly/test site.

SYMBOL (EACH AMPLIFIER)

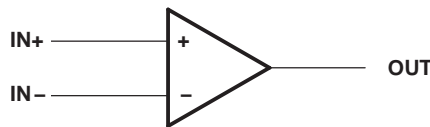

Please be aware that an important notice concerning availability, standard warranty, and use in critical applications of Texas Instruments semiconductor products and disclaimers thereto appears at the end of this data sheet.

MC33078
DUAL HIGH-SPEED LOW-NOISE OPERATIONAL AMPLIFIER

SLLS633C – OCTOBER 2004 – REVISED NOVEMBER 2006

Absolute Maximum Ratings⁽¹⁾

over operating free-air temperature range (unless otherwise noted)

| | | MIN | MAX | UNIT |
|-------------------------------------|---|-------------|--------------------------------------|------|
| V _{CC+} | Supply voltage ⁽²⁾ | | 18 | V |
| V _{CC-} | Supply voltage ⁽²⁾ | | -18 | V |
| V _{CC+} – V _{CC-} | Supply voltage | | 36 | V |
| | Input voltage, either input ⁽²⁾⁽³⁾ | | V _{CC+} or V _{CC-} | V |
| | Input current ⁽⁴⁾ | | ±10 | mA |
| | Duration of output short circuit ⁽⁵⁾ | | Unlimited | |
| θ _{JA} | Package thermal impedance, junction to free air ⁽⁶⁾⁽⁷⁾ | D package | 97 | °C/W |
| | | DGK package | 172 | |
| | | P package | 85 | |
| T _J | Operating virtual junction temperature | | 150 | °C |
| T _{stg} | Storage temperature range | -65 | 150 | °C |

- (1) Stresses beyond those listed under *Absolute Maximum Ratings* may cause permanent damage to the device. These are stress ratings only, and functional operation of the device at these or any other conditions beyond those indicated under *Recommended Operating Conditions* is not implied. Exposure to absolute-maximum-rated conditions for extended periods may affect device reliability.
- (2) All voltage values, except differential voltages, are with respect to the midpoint between V_{CC+} and V_{CC-}.
- (3) The magnitude of the input voltage must never exceed the magnitude of the supply voltage.
- (4) Excessive input current will flow if a differential input voltage in excess of approximately 0.6 V is applied between the inputs, unless some limiting resistance is used.
- (5) The output may be shorted to ground or either power supply. Temperature and/or supply voltages must be limited to ensure the maximum dissipation rating is not exceeded.
- (6) Maximum power dissipation is a function of T_{J(max)}, θ_{JA}, and T_A. The maximum allowable power dissipation at any allowable ambient temperature is P_D = (T_{J(max)} – T_A)/θ_{JA}. Operating at the absolute maximum T_J of 150°C can affect reliability.
- (7) The package thermal impedance is calculated in accordance with JESD 51-7.

Recommended Operating Conditions

| | | MIN | MAX | UNIT |
|------------------|--------------------------------------|-----|-----|------|
| V _{CC-} | Supply voltage | -5 | -18 | V |
| V _{CC+} | | 5 | 18 | |
| T _A | Operating free-air temperature range | -40 | 85 | °C |

Electrical Characteristics

$V_{CC-} = -15\text{ V}$, $V_{CC+} = 15\text{ V}$, $T_A = 25^\circ\text{C}$ (unless otherwise noted)

| PARAMETER | | TEST CONDITIONS | | MIN | TYP | MAX | UNIT | |
|-----------------|---|---|---|-----------|----------|-------|------------------------------|----|
| V_{IO} | Input offset voltage | $V_O = 0$, $R_S = 10\ \Omega$, $V_{CM} = 0$ | $T_A = 25^\circ\text{C}$ | 0.15 | 2 | 3 | mV | |
| | | | $T_A = -40^\circ\text{C}$ to 85°C | | | | | |
| αV_{IO} | Input offset voltage temperature coefficient | $V_O = 0$, $R_S = 10\ \Omega$, $V_{CM} = 0$ | $T_A = -40^\circ\text{C}$ to 85°C | | 2 | | $\mu\text{V}/^\circ\text{C}$ | |
| I_{IB} | Input bias current | $V_O = 0$, $V_{CM} = 0$ | $T_A = 25^\circ\text{C}$ | 300 | 750 | 800 | nA | |
| | | | $T_A = -40^\circ\text{C}$ to 85°C | | | | | |
| I_{IO} | Input offset current | $V_O = 0$, $V_{CM} = 0$ | $T_A = 25^\circ\text{C}$ | 25 | 150 | 175 | nA | |
| | | | $T_A = -40^\circ\text{C}$ to 85°C | | | | | |
| V_{ICR} | Common-mode input voltage range | $\Delta V_{IO} = 5\text{ mV}$, $V_O = 0$ | | ± 13 | ± 14 | | V | |
| A_{VD} | Large-signal differential voltage amplification | $R_L \geq 2\text{ k}\Omega$, $V_O = \pm 10\text{ V}$ | $T_A = 25^\circ\text{C}$ | 90 | 110 | 85 | dB | |
| | | | $T_A = -40^\circ\text{C}$ to 85°C | | | | | |
| V_{OM} | Maximum output voltage swing | $V_{ID} = \pm 1\text{ V}$ | $R_L = 600\ \Omega$ | V_{OM+} | 10.7 | | V | |
| | | | | V_{OM-} | -11.9 | | | |
| | | | $R_L = 2\text{ k}\Omega$ | V_{OM+} | 13.2 | 13.8 | | |
| | | | | V_{OM-} | -13.2 | -13.7 | | |
| | | | $R_L = 10\text{ k}\Omega$ | V_{OM+} | 13.5 | 14.1 | | |
| | | | | V_{OM-} | -14 | -14.6 | | |
| CMMR | Common-mode rejection ratio | $V_{IN} = \pm 13\text{ V}$ | | 80 | 100 | | dB | |
| $k_{SVR}^{(1)}$ | Supply-voltage rejection ratio | $V_{CC+} = 5\text{ V}$ to 15 V , $V_{CC-} = -5\text{ V}$ to -15 V | | 80 | 105 | | dB | |
| I_{OS} | Output short-circuit current | $ V_{ID} = 1\text{ V}$, Output to GND | Source current | 15 | 29 | -20 | -37 | mA |
| | | | Sink current | | | | | |
| I_{CC} | Supply current (per channel) | $V_O = 0$ | $T_A = 25^\circ\text{C}$ | 2.05 | 2.5 | 2.75 | mA | |
| | | | $T_A = -40^\circ\text{C}$ to 85°C | | | | | |

(1) Measured with $V_{CC\pm}$ differentially varied at the same time

Operating Characteristics

$V_{CC-} = -15\text{ V}$, $V_{CC+} = 15\text{ V}$, $T_A = 25^\circ\text{C}$ (unless otherwise noted)

| PARAMETER | | TEST CONDITIONS | | MIN | TYP | MAX | UNIT |
|----------------------|--------------------------------|---|-----------------------|-----|-------|-----|------------------------------|
| SR | Slew rate at unity gain | $A_{VD} = 1$, $V_{IN} = -10\text{ V}$ to 10 V , $R_L = 2\text{ k}\Omega$, $C_L = 100\text{ pF}$ | | 5 | 7 | | $\text{V}/\mu\text{s}$ |
| GBW | Gain bandwidth product | $f = 100\text{ kHz}$ | | 10 | 16 | | MHz |
| B_1 | Unity gain frequency | Open loop | | | 9 | | MHz |
| G_m | Gain margin | $R_L = 2\text{ k}\Omega$ | $C_L = 0\text{ pF}$ | | -11 | | dB |
| | | | $C_L = 100\text{ pF}$ | | -6 | | |
| Φ_m | Phase margin | $R_L = 2\text{ k}\Omega$ | $C_L = 0\text{ pF}$ | | 55 | | deg |
| | | | $C_L = 100\text{ pF}$ | | 40 | | |
| Amp-to-amp isolation | | $f = 20\text{ Hz}$ to 20 kHz | | | -120 | | dB |
| Power bandwidth | | $V_O = 27\text{ V}_{(PP)}$, $R_L = 2\text{ k}\Omega$, $\text{THD} \leq 1\%$ | | | 120 | | kHz |
| THD | Total harmonic distortion | $V_O = 3\text{ V}_{\text{rms}}$, $A_{VD} = 1$, $R_L = 2\text{ k}\Omega$, $f = 20\text{ Hz}$ to 20 kHz | | | 0.002 | | % |
| Z_o | Open-loop output impedance | $V_O = 0$, $f = 9\text{ MHz}$ | | | 37 | | Ω |
| r_{id} | Differential input resistance | $V_{CM} = 0$ | | | 175 | | $\text{k}\Omega$ |
| C_{id} | Differential input capacitance | $V_{CM} = 0$ | | | 12 | | pF |
| V_n | Equivalent input noise voltage | $f = 1\text{ kHz}$, $R_S = 100\ \Omega$ | | | 4.5 | | $\text{nV}/\sqrt{\text{Hz}}$ |
| I_n | Equivalent input noise current | $f = 1\text{ kHz}$ | | | 0.5 | | $\text{pA}/\sqrt{\text{Hz}}$ |

MC33078
DUAL HIGH-SPEED LOW-NOISE OPERATIONAL AMPLIFIER

SLLS633C – OCTOBER 2004 – REVISED NOVEMBER 2006

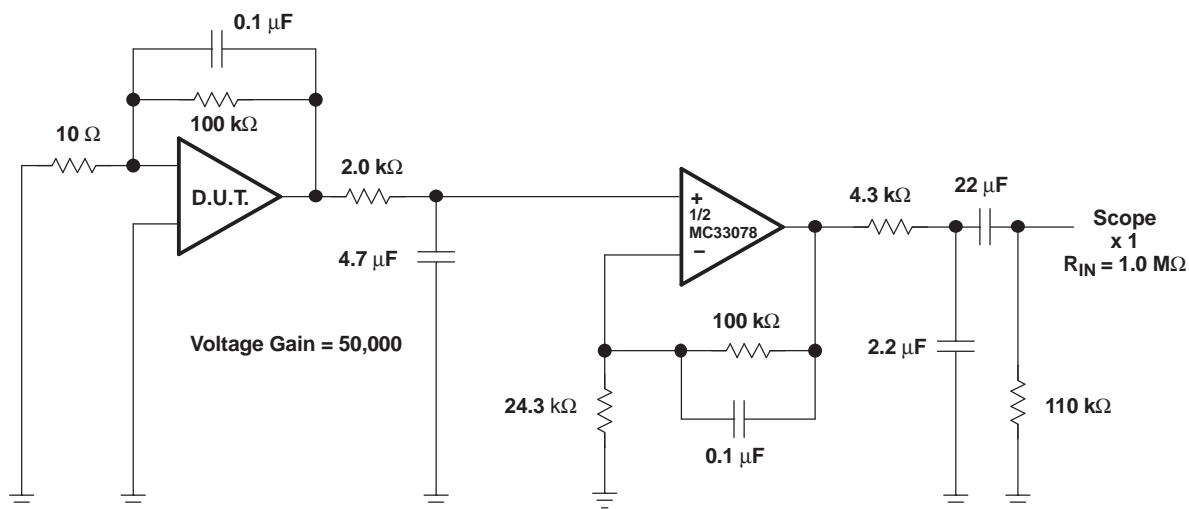

NOTE: All capacitors are non-polarized.

Figure 1. Voltage Noise Test Circuit (0.1 Hz to 10 Hz)

EEPW.com.cn 电子产业世界

TYPICAL CHARACTERISTICS

INPUT BIAS CURRENT
 VS
COMMON-MODE VOLTAGE

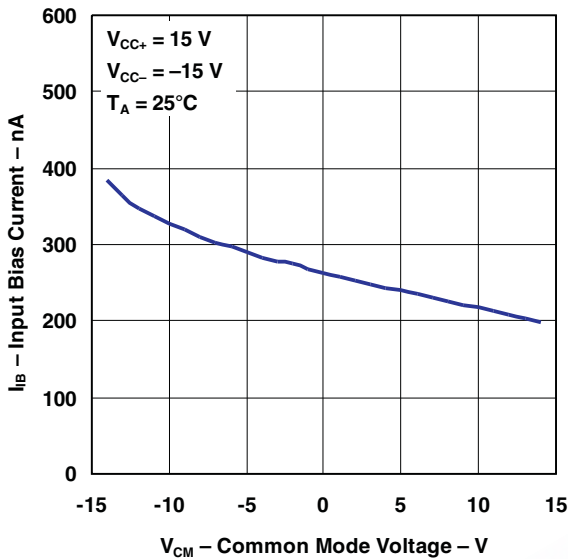

INPUT BIAS CURRENT
 VS
SUPPLY VOLTAGE

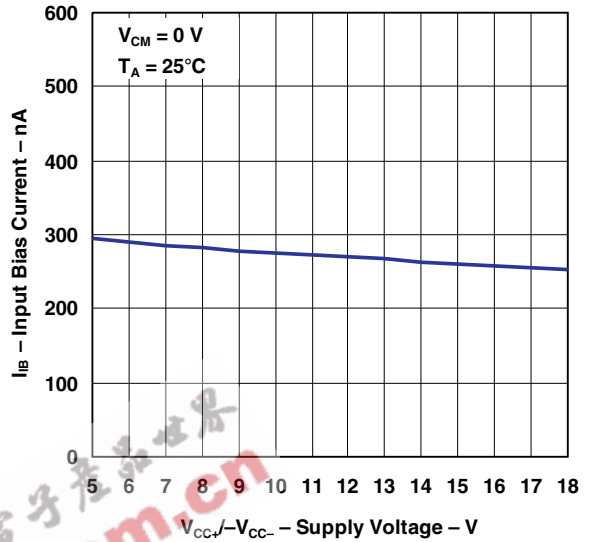

INPUT BIAS CURRENT
 VS
TEMPERATURE

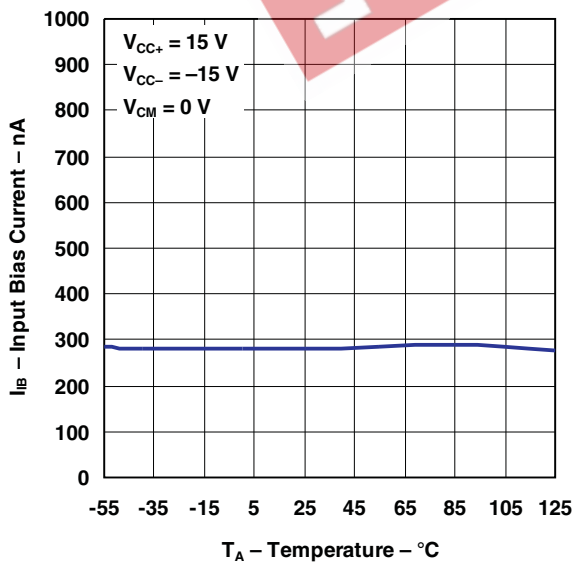

INPUT OFFSET VOLTAGE
 VS
TEMPERATURE

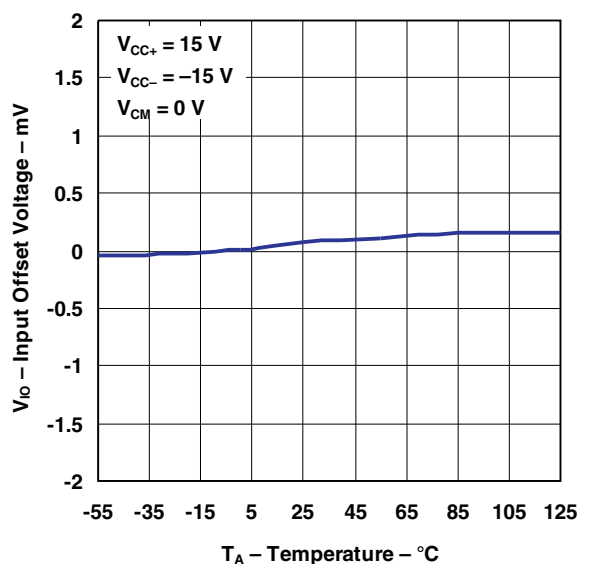

TYPICAL CHARACTERISTICS (continued)

INPUT COMMON-MODE VOLTAGE
 LOW PROXIMITY TO V_{CC-}
 VS
 TEMPERATURE

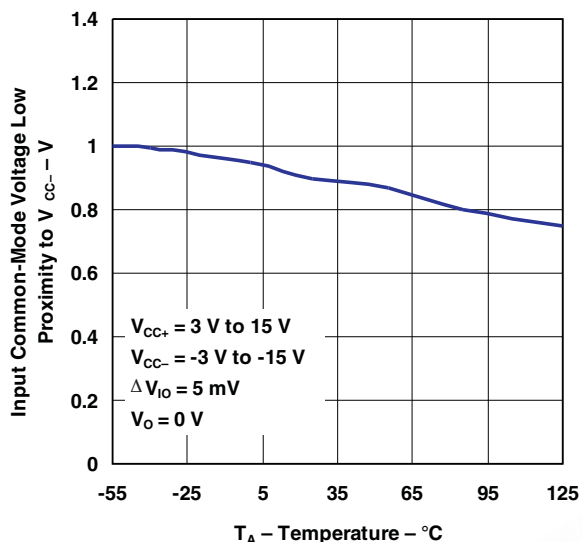

INPUT COMMON-MODE VOLTAGE
 HIGH PROXIMITY TO V_{CC+}
 VS
 TEMPERATURE

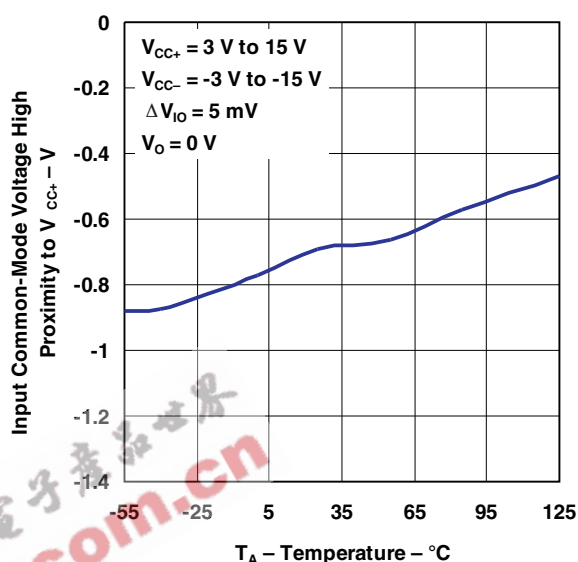

OUTPUT SATURATION VOLTAGE PROXIMITY TO V_{CC+}
 VS
 LOAD RESISTANCE

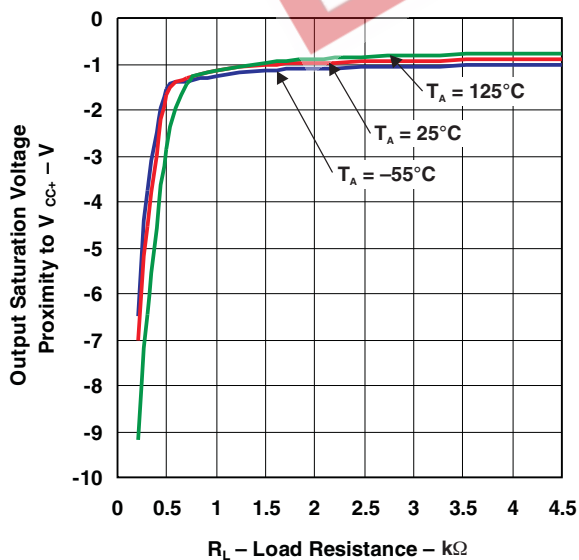

OUTPUT SATURATION VOLTAGE PROXIMITY TO V_{CC-}
 VS
 LOAD RESISTANCE

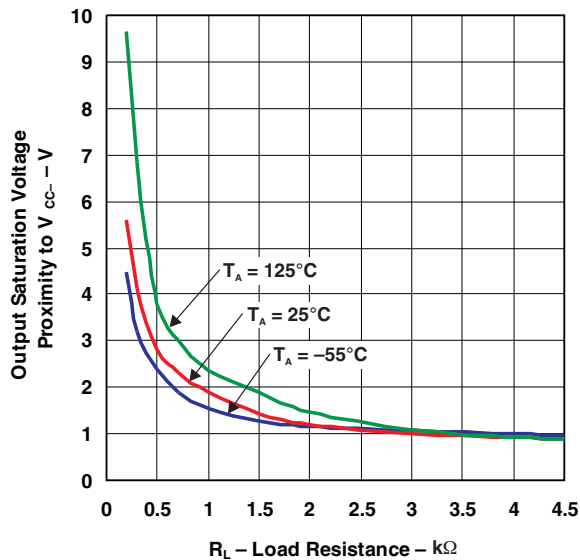

TYPICAL CHARACTERISTICS (continued)

OUTPUT SHORT-CIRCUIT CURRENT
VS
TEMPERATURE

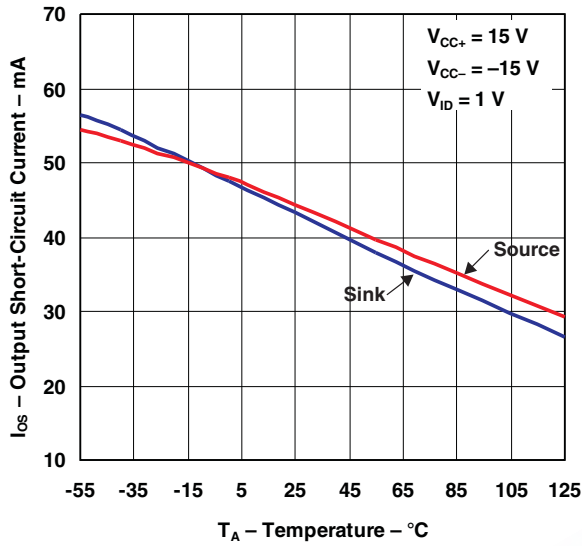

SUPPLY CURRENT
VS
TEMPERATURE

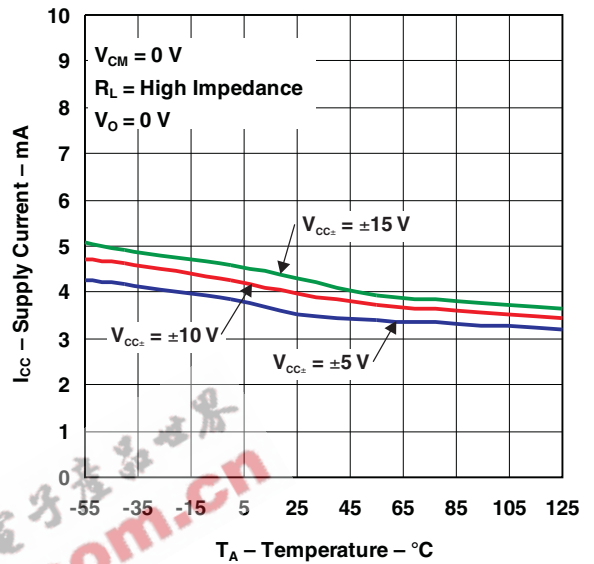

CMRR
VS
FREQUENCY

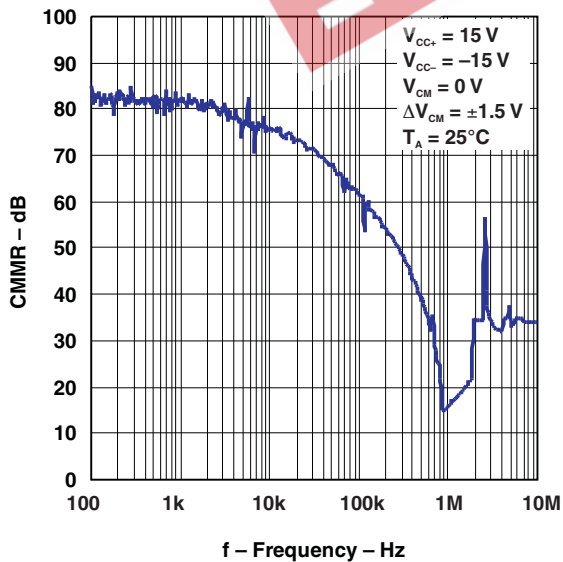

PSSR
VS
FREQUENCY

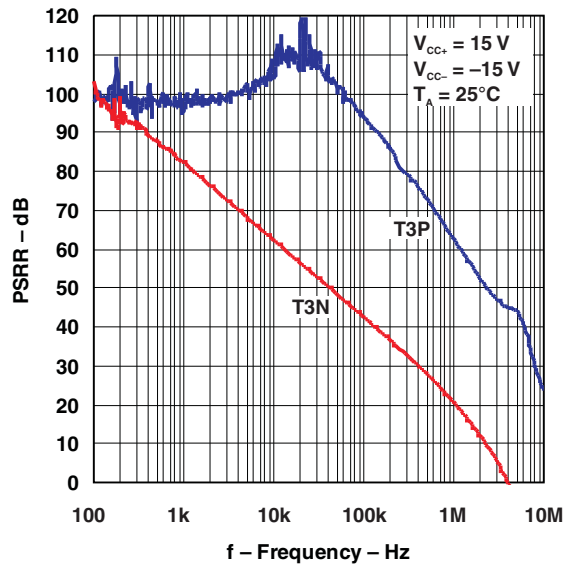

TYPICAL CHARACTERISTICS (continued)

GAIN BANDWIDTH PRODUCT
 VS
 SUPPLY VOLTAGE

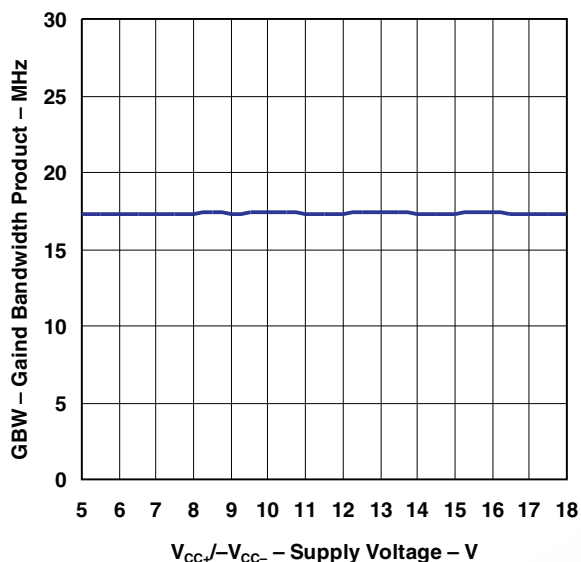

GAIN BANDWIDTH PRODUCT
 VS
 TEMPERATURE

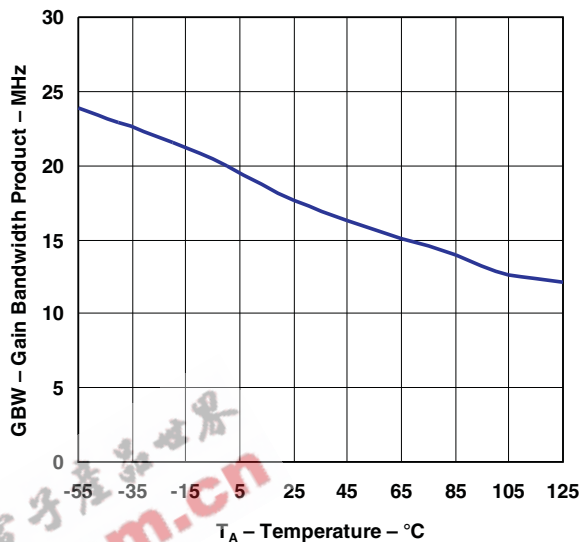

OUTPUT VOLTAGE
 VS
 SUPPLY VOLTAGE

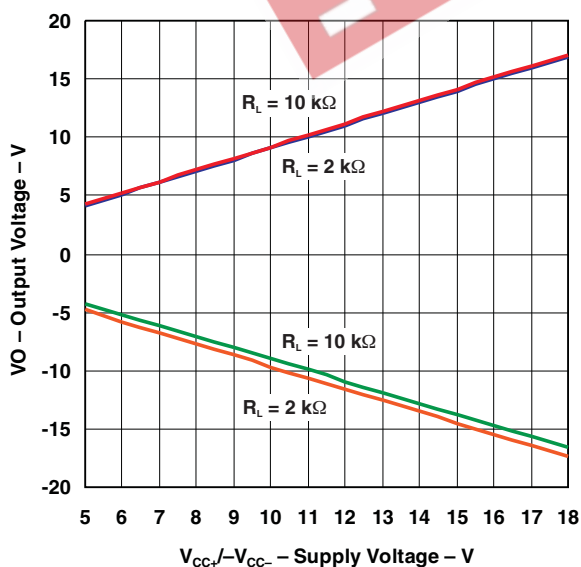

OUTPUT VOLTAGE
 VS
 FREQUENCY

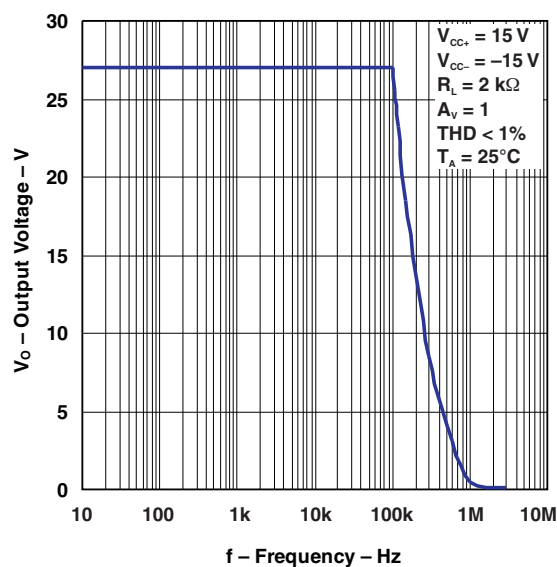

TYPICAL CHARACTERISTICS (continued)

**OPEN-LOOP GAIN
vs
SUPPLY VOLTAGE**

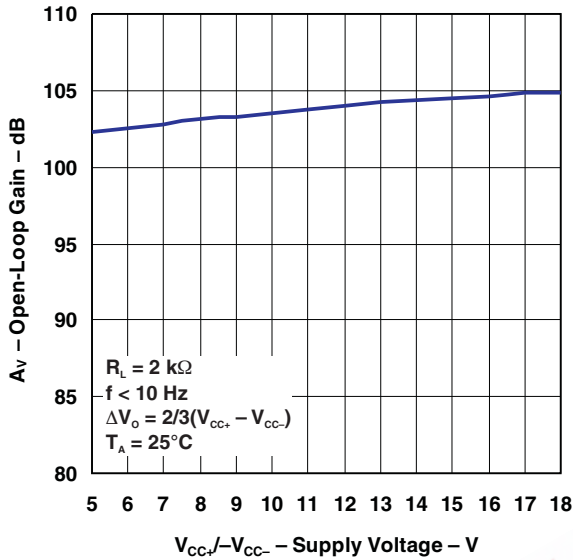

**OPEN-LOOP GAIN
vs
TEMPERATURE**

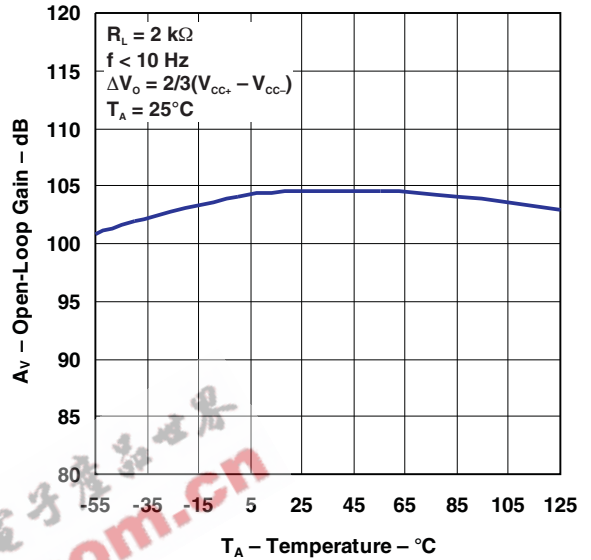

**OUTPUT IMPEDANCE
vs
FREQUENCY**

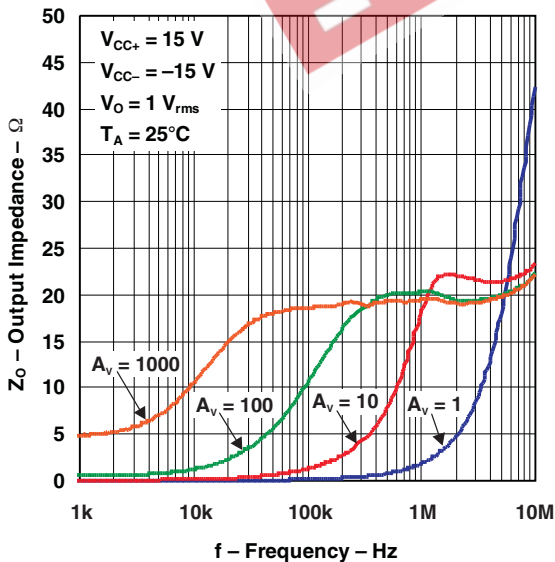

**CROSSTALK REJECTION
vs
FREQUENCY**

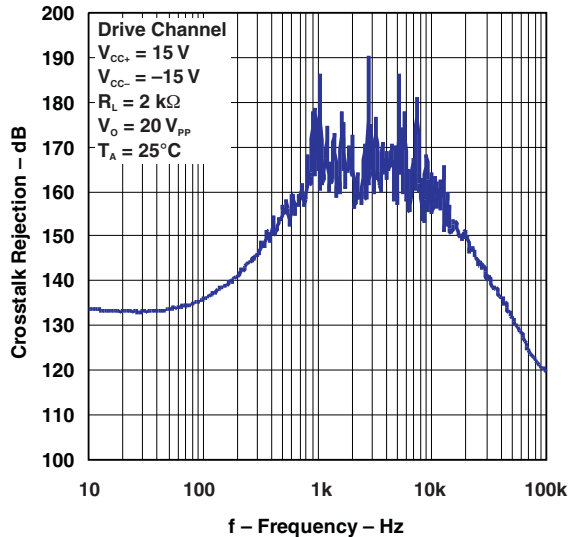

TYPICAL CHARACTERISTICS (continued)

TOTAL HARMONIC DISTORTION
 VS
 FREQUENCY

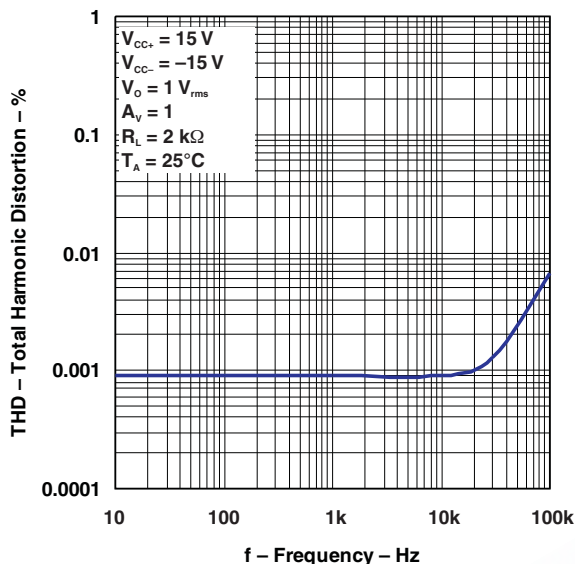

TOTAL HARMONIC DISTORTION
 VS
 OUTPUT VOLTAGE

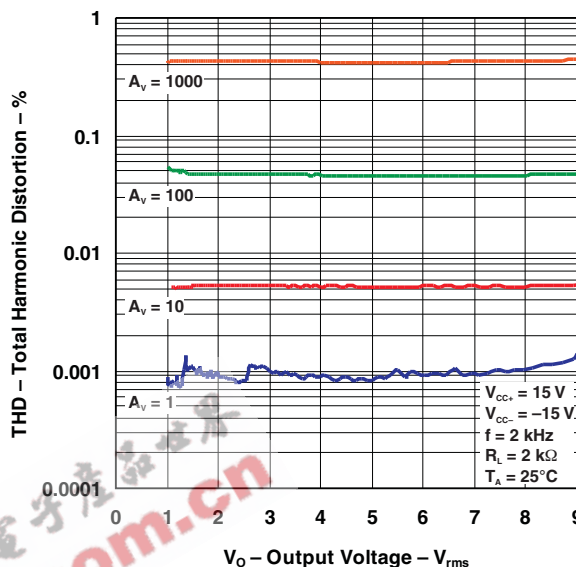

SLEW RATE
 VS
 SUPPLY VOLTAGE

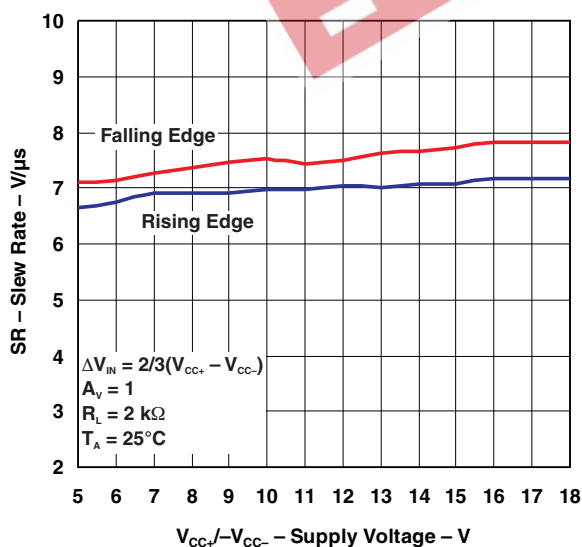

SLEW RATE
 VS
 TEMPERATURE

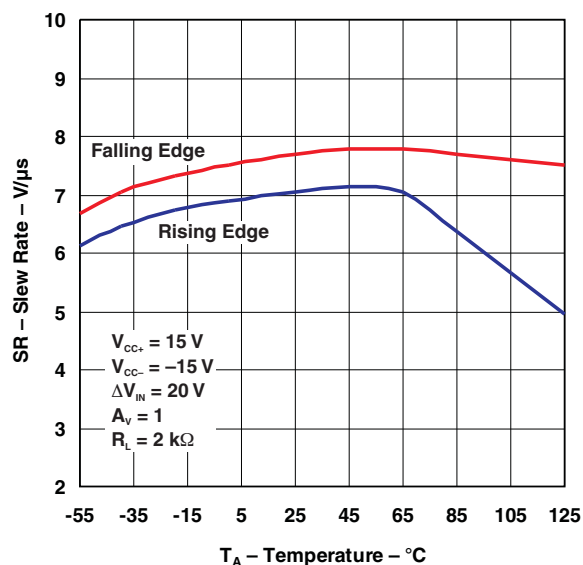

TYPICAL CHARACTERISTICS (continued)

GAIN AND PHASE VS FREQUENCY

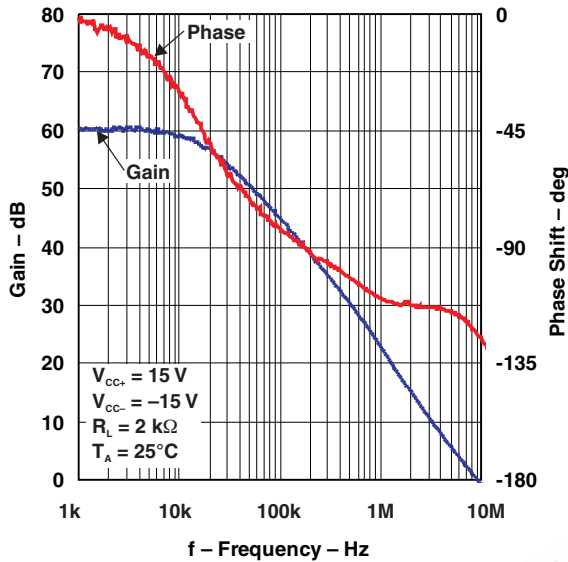

GAIN AND PHASE MARGIN VS OUTPUT LOAD CAPACITANCE

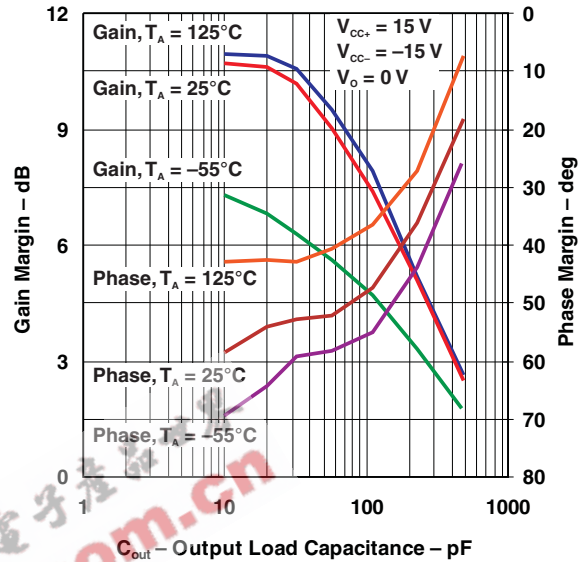

OVERSHOOT VS OUTPUT LOAD CAPACITANCE

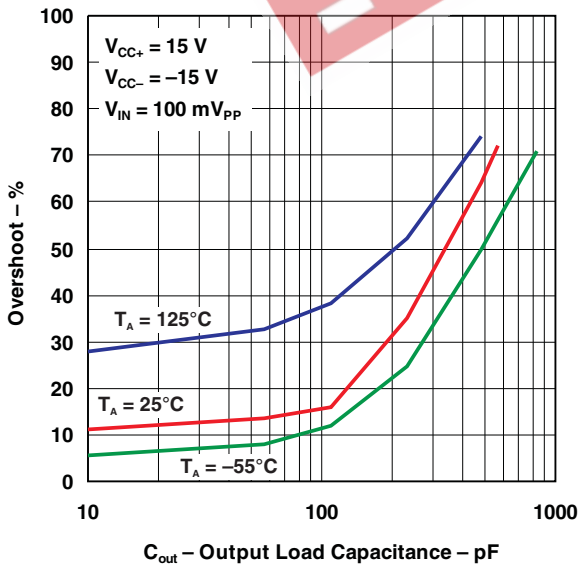

INPUT VOLTAGE AND CURRENT NOISE VS FREQUENCY

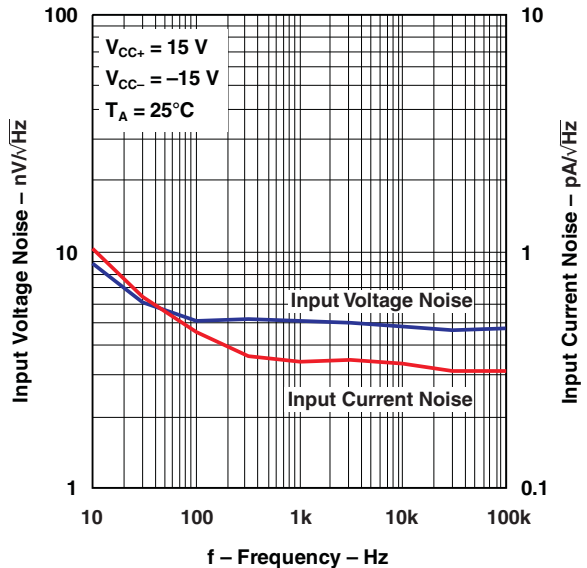

TYPICAL CHARACTERISTICS (continued)

INPUT REFERRED NOISE VOLTAGE
 VS
 SOURCE RESISTANCE

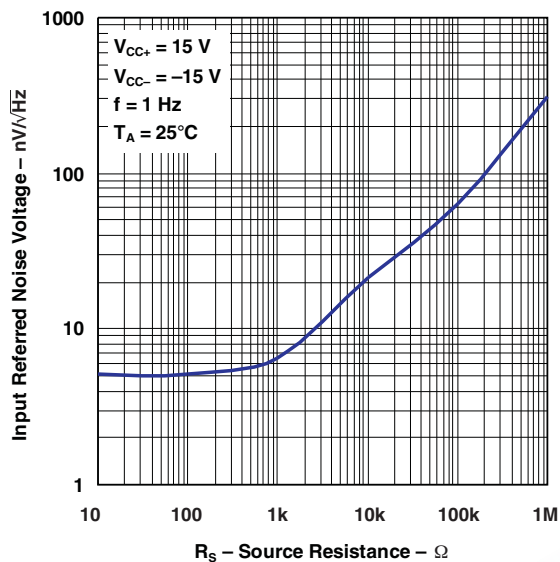

GAIN AND PHASE MARGIN
 VS
 DIFFERENTIAL SOURCE RESISTANCE

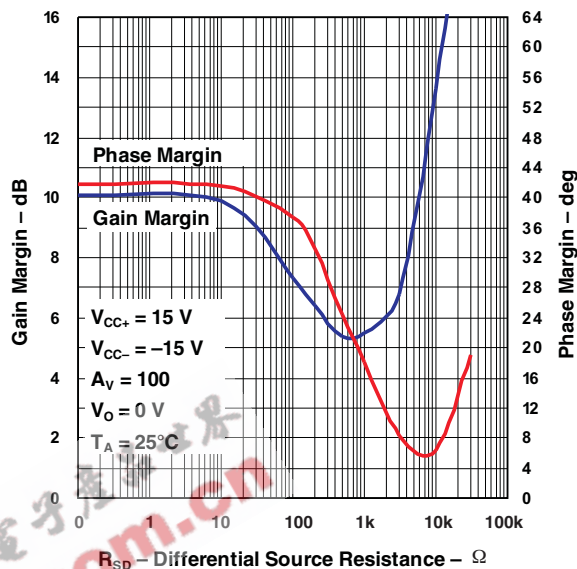

LARGE SIGNAL TRANSIENT RESPONSE
 (AV = 1)

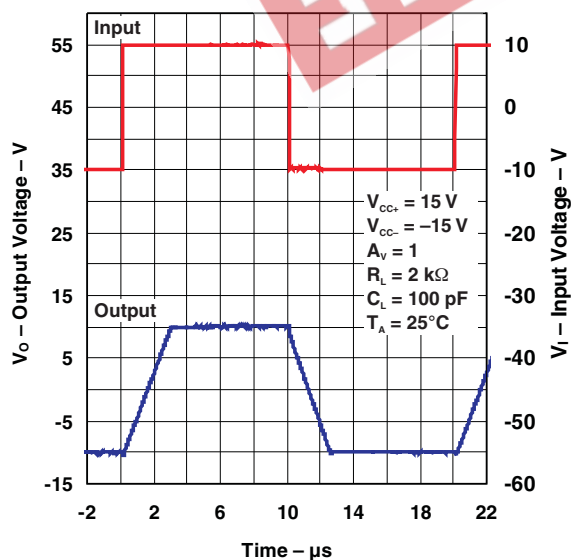

LARGE SIGNAL TRANSIENT RESPONSE
 (AV = -1)

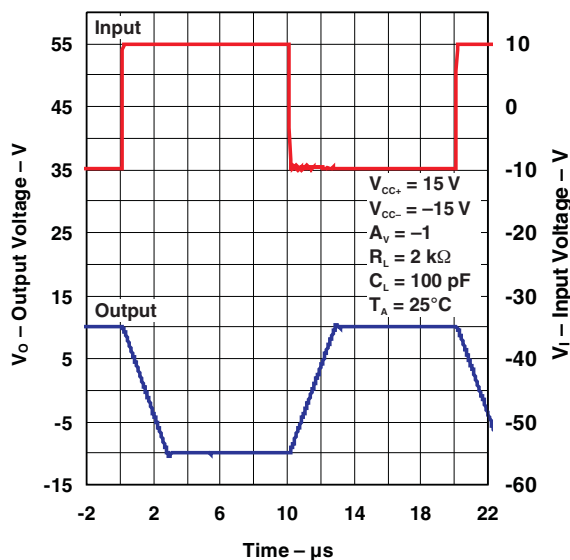

TYPICAL CHARACTERISTICS (continued)

SMALL SIGNAL TRANSIENT RESPONSE

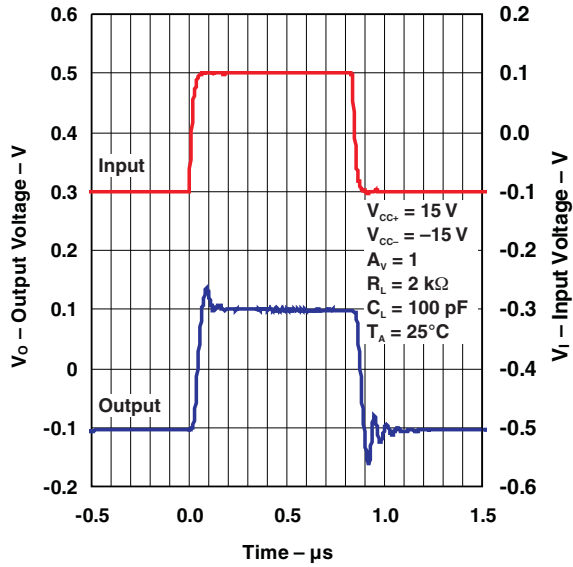

LOW_FREQUENCY NOISE

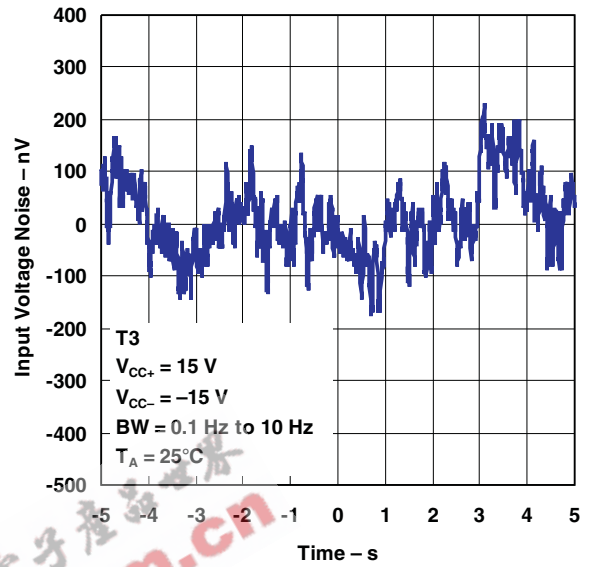

EEPW.com.cn 电子产业网

APPLICATION INFORMATION

Output Characteristics

All operating characteristics are specified with 100-pF load capacitance. The MC33078 can drive higher capacitance loads. However, as the load capacitance increases, the resulting response pole occurs at lower frequencies, causing ringing, peaking, or oscillation. The value of the load capacitance at which oscillation occurs varies from lot to lot. If an application appears to be sensitive to oscillation due to load capacitance, adding a small resistance in series with the load should alleviate the problem (see Figure 2).

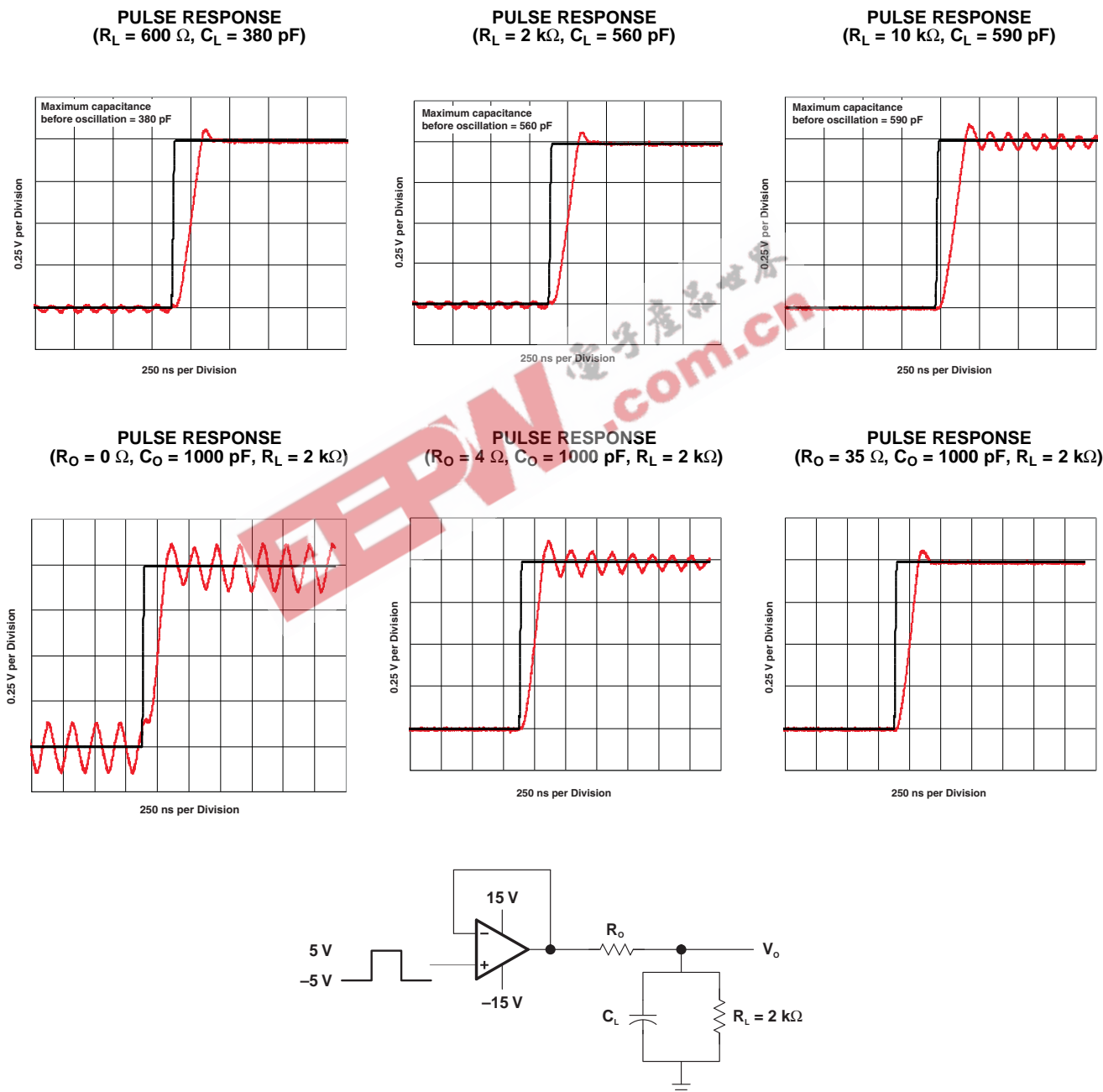

Figure 2. Output Characteristics

PACKAGING INFORMATION

| Orderable Device | Status ⁽¹⁾ | Package Type | Package Drawing | Pins | Package Qty | Eco Plan ⁽²⁾ | Lead/Ball Finish | MSL Peak Temp ⁽³⁾ |
|------------------|-----------------------|--------------|-----------------|------|-------------|-------------------------|------------------|------------------------------|
| MC33078D | ACTIVE | SOIC | D | 8 | 75 | Green (RoHS & no Sb/Br) | CU NIPDAU | Level-1-260C-UNLIM |
| MC33078DE4 | ACTIVE | SOIC | D | 8 | 75 | Green (RoHS & no Sb/Br) | CU NIPDAU | Level-1-260C-UNLIM |
| MC33078DGKR | ACTIVE | MSOP | DGK | 8 | 2500 | Green (RoHS & no Sb/Br) | CU NIPDAU | Level-1-260C-UNLIM |
| MC33078DGKRG4 | ACTIVE | MSOP | DGK | 8 | 2500 | Green (RoHS & no Sb/Br) | CU NIPDAU | Level-1-260C-UNLIM |
| MC33078DGKT | ACTIVE | MSOP | DGK | 8 | 250 | Green (RoHS & no Sb/Br) | CU NIPDAU | Level-1-260C-UNLIM |
| MC33078DGKTG4 | ACTIVE | MSOP | DGK | 8 | 250 | Green (RoHS & no Sb/Br) | CU NIPDAU | Level-1-260C-UNLIM |
| MC33078DR | ACTIVE | SOIC | D | 8 | 2500 | Green (RoHS & no Sb/Br) | CU NIPDAU | Level-1-260C-UNLIM |
| MC33078DRE4 | ACTIVE | SOIC | D | 8 | 2500 | Green (RoHS & no Sb/Br) | CU NIPDAU | Level-1-260C-UNLIM |
| MC33078P | ACTIVE | PDIP | P | 8 | 50 | Pb-Free (RoHS) | CU NIPDAU | N / A for Pkg Type |
| MC33078PE4 | ACTIVE | PDIP | P | 8 | 50 | Pb-Free (RoHS) | CU NIPDAU | N / A for Pkg Type |

⁽¹⁾ The marketing status values are defined as follows:

ACTIVE: Product device recommended for new designs.

LIFEBUY: TI has announced that the device will be discontinued, and a lifetime-buy period is in effect.

NRND: Not recommended for new designs. Device is in production to support existing customers, but TI does not recommend using this part in a new design.

PREVIEW: Device has been announced but is not in production. Samples may or may not be available.

OBSOLETE: TI has discontinued the production of the device.

⁽²⁾ Eco Plan - The planned eco-friendly classification: Pb-Free (RoHS), Pb-Free (RoHS Exempt), or Green (RoHS & no Sb/Br) - please check <http://www.ti.com/productcontent> for the latest availability information and additional product content details.

TBD: The Pb-Free/Green conversion plan has not been defined.

Pb-Free (RoHS): TI's terms "Lead-Free" or "Pb-Free" mean semiconductor products that are compatible with the current RoHS requirements for all 6 substances, including the requirement that lead not exceed 0.1% by weight in homogeneous materials. Where designed to be soldered at high temperatures, TI Pb-Free products are suitable for use in specified lead-free processes.

Pb-Free (RoHS Exempt): This component has a RoHS exemption for either 1) lead-based flip-chip solder bumps used between the die and package, or 2) lead-based die adhesive used between the die and leadframe. The component is otherwise considered Pb-Free (RoHS compatible) as defined above.

Green (RoHS & no Sb/Br): TI defines "Green" to mean Pb-Free (RoHS compatible), and free of Bromine (Br) and Antimony (Sb) based flame retardants (Br or Sb do not exceed 0.1% by weight in homogeneous material)

⁽³⁾ MSL, Peak Temp. -- The Moisture Sensitivity Level rating according to the JEDEC industry standard classifications, and peak solder temperature.

Important Information and Disclaimer: The information provided on this page represents TI's knowledge and belief as of the date that it is provided. TI bases its knowledge and belief on information provided by third parties, and makes no representation or warranty as to the accuracy of such information. Efforts are underway to better integrate information from third parties. TI has taken and continues to take reasonable steps to provide representative and accurate information but may not have conducted destructive testing or chemical analysis on incoming materials and chemicals. TI and TI suppliers consider certain information to be proprietary, and thus CAS numbers and other limited information may not be available for release.

In no event shall TI's liability arising out of such information exceed the total purchase price of the TI part(s) at issue in this document sold by TI to Customer on an annual basis.

MECHANICAL DATA

MPDI001A – JANUARY 1995 – REVISED JUNE 1999

P (R-PDIP-T8)

PLASTIC DUAL-IN-LINE



- NOTES: A. All linear dimensions are in inches (millimeters).
 B. This drawing is subject to change without notice.
 C. Falls within JEDEC MS-001

For the latest package information, go to http://www.ti.com/sc/docs/package/pkg_info.htm



POST OFFICE BOX 655303 • DALLAS, TEXAS 75265

MECHANICAL DATA

DGK (S-PDSO-G8)

PLASTIC SMALL-OUTLINE PACKAGE

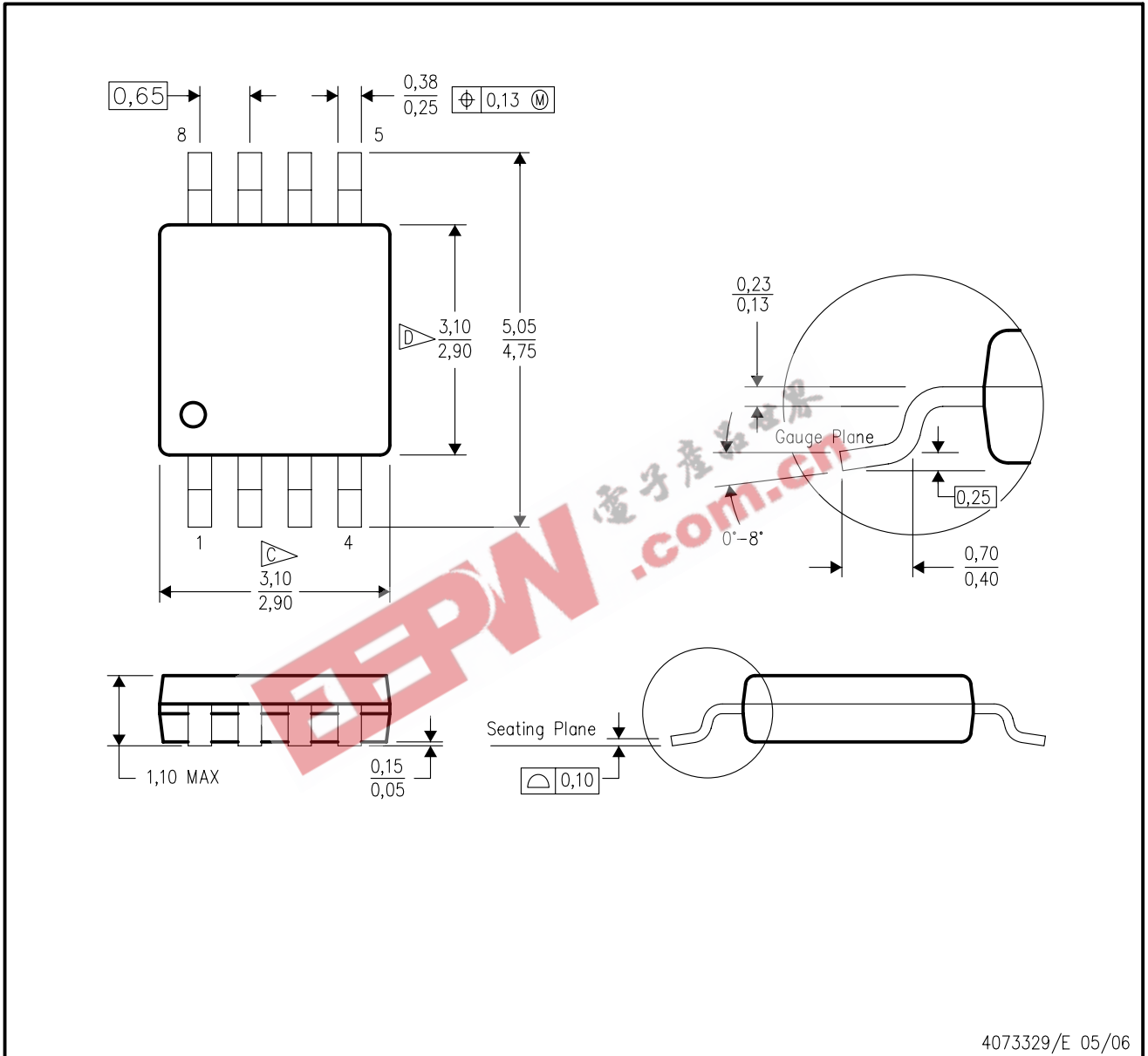

- NOTES:
- A. All linear dimensions are in millimeters.
 - B. This drawing is subject to change without notice.
 - C. Body length does not include mold flash, protrusions, or gate burrs. Mold flash, protrusions, or gate burrs shall not exceed 0.15 per end.
 - D. Body width does not include interlead flash. Interlead flash shall not exceed 0.50 per side.
 - E. Falls within JEDEC MO-187 variation AA, except interlead flash.

MECHANICAL DATA

D (R-PDSO-G8)

PLASTIC SMALL-OUTLINE PACKAGE

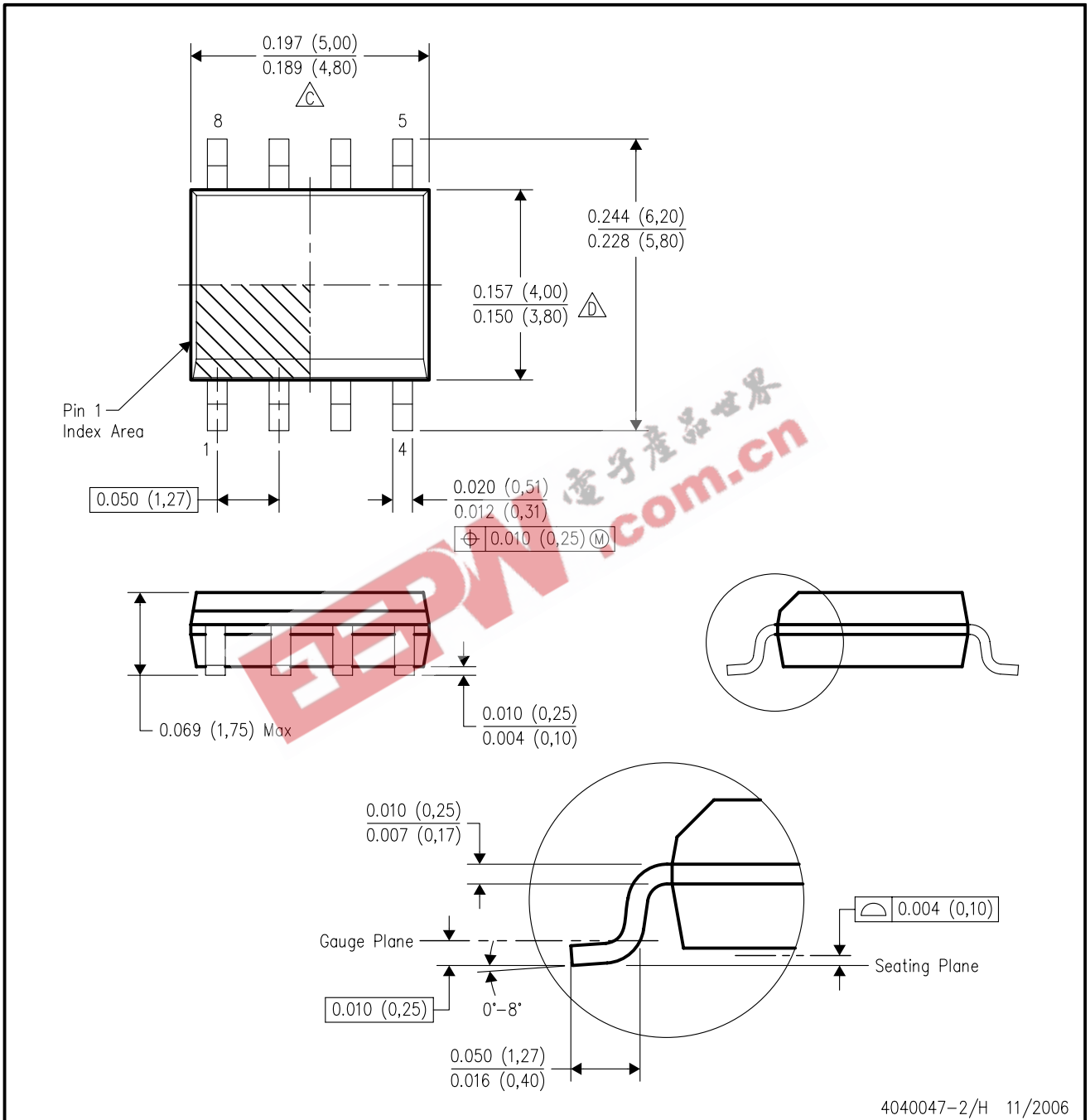

- NOTES:
- A. All linear dimensions are in inches (millimeters).
 - B. This drawing is subject to change without notice.
 - $\triangle C$ Body length does not include mold flash, protrusions, or gate burrs. Mold flash, protrusions, or gate burrs shall not exceed .006 (0,15) per end.
 - $\triangle D$ Body width does not include interlead flash. Interlead flash shall not exceed .017 (0,43) per side.
 - E. Reference JEDEC MS-012 variation AA.

IMPORTANT NOTICE

Texas Instruments Incorporated and its subsidiaries (TI) reserve the right to make corrections, modifications, enhancements, improvements, and other changes to its products and services at any time and to discontinue any product or service without notice. Customers should obtain the latest relevant information before placing orders and should verify that such information is current and complete. All products are sold subject to TI's terms and conditions of sale supplied at the time of order acknowledgment.

TI warrants performance of its hardware products to the specifications applicable at the time of sale in accordance with TI's standard warranty. Testing and other quality control techniques are used to the extent TI deems necessary to support this warranty. Except where mandated by government requirements, testing of all parameters of each product is not necessarily performed.

TI assumes no liability for applications assistance or customer product design. Customers are responsible for their products and applications using TI components. To minimize the risks associated with customer products and applications, customers should provide adequate design and operating safeguards.

TI does not warrant or represent that any license, either express or implied, is granted under any TI patent right, copyright, mask work right, or other TI intellectual property right relating to any combination, machine, or process in which TI products or services are used. Information published by TI regarding third-party products or services does not constitute a license from TI to use such products or services or a warranty or endorsement thereof. Use of such information may require a license from a third party under the patents or other intellectual property of the third party, or a license from TI under the patents or other intellectual property of TI.

Reproduction of information in TI data books or data sheets is permissible only if reproduction is without alteration and is accompanied by all associated warranties, conditions, limitations, and notices. Reproduction of this information with alteration is an unfair and deceptive business practice. TI is not responsible or liable for such altered documentation.

Resale of TI products or services with statements different from or beyond the parameters stated by TI for that product or service voids all express and any implied warranties for the associated TI product or service and is an unfair and deceptive business practice. TI is not responsible or liable for any such statements.

Following are URLs where you can obtain information on other Texas Instruments products and application solutions:

| Products | | Applications | |
|--------------------|--|---------------------|--|
| Amplifiers | amplifier.ti.com | Audio | www.ti.com/audio |
| Data Converters | dataconverter.ti.com | Automotive | www.ti.com/automotive |
| DSP | dsp.ti.com | Broadband | www.ti.com/broadband |
| Interface | interface.ti.com | Digital Control | www.ti.com/digitalcontrol |
| Logic | logic.ti.com | Military | www.ti.com/military |
| Power Mgmt | power.ti.com | Optical Networking | www.ti.com/opticalnetwork |
| Microcontrollers | microcontroller.ti.com | Security | www.ti.com/security |
| Low Power Wireless | www.ti.com/lpw | Telephony | www.ti.com/telephony |
| | | Video & Imaging | www.ti.com/video |
| | | Wireless | www.ti.com/wireless |

Mailing Address: Texas Instruments
Post Office Box 655303 Dallas, Texas 75265