

# MC33076

## Dual High Output Current, Low Power, Low Noise Bipolar Operational Amplifier

The MC33076 operational amplifier employs bipolar technology with innovative high performance concepts for audio and industrial applications. This device uses high frequency PNP input transistors to improve frequency response. In addition, the amplifier provides high output current drive capability while minimizing the drain current. The all NPN output stage exhibits no deadband crossover distortion, large output voltage swing, excellent phase and gain margins, low open loop high frequency output impedance and symmetrical source and sink AC frequency performance.

The MC33076 is tested over the automotive temperature range and is available in an 8-pin SOIC package (D suffix) and in the standard 8 pin DIP package for high power applications.

- 100  $\Omega$  Output Drive Capability
- Large Output Voltage Swing
- Low Total Harmonic Distortion
- High Gain Bandwidth: 7.4 MHz
- High Slew Rate: 2.6 V/ $\mu$ s
- Dual Supply Operation:  $\pm 2.0$  V to  $\pm 18$  V
- High Output Current: ISC = 250 mA typ
- Similar Performance to MC33178

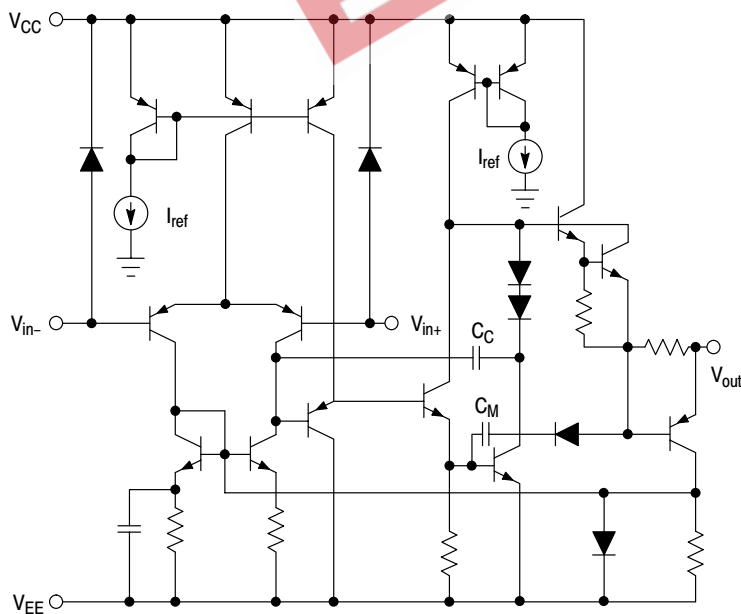


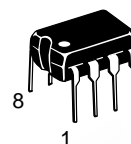
Figure 1. Equivalent Circuit Schematic (Each Amplifier)



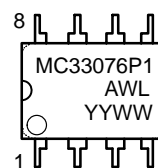
ON Semiconductor™

<http://onsemi.com>

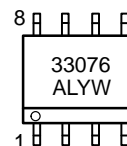
### MARKING DIAGRAMS



PDIP-8  
P1 SUFFIX  
CASE 626

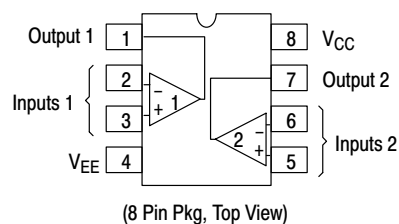


SO-8  
D SUFFIX  
CASE 751



A = Assembly Location  
WL, L = Wafer Lot  
YY, Y = Year  
WW, W = Work Week

### PIN CONNECTIONS



### ORDERING INFORMATION

| Device     | Package | Shipping         |
|------------|---------|------------------|
| MC33076D   | SO-8    | 98 Units/Rail    |
| MC33076DR2 | SO-8    | 2500 Tape & Reel |
| MC33076P1  | PDIP-8  | 50 Units/Rail    |

# MC33076

## MAXIMUM RATINGS

| Rating                                  | Symbol               | Value       | Unit |
|---|----------------------|-------------|------|
| Power Supply Voltage (Note 2.)          | $V_{CC}$ to $V_{EE}$ | +36         | V    |
| Input Differential Voltage Range        | $V_{IDR}$            | Note 1.     | V    |
| Input Voltage Range                     | $V_{IR}$             | Note 1.     | V    |
| Output Short Circuit Duration (Note 2.) | $t_{SC}$             | 5.0         | sec  |
| Maximum Junction Temperature            | $T_J$                | +150        | °C   |
| Storage Temperature                     | $T_{stg}$            | -60 to +150 | °C   |
| Maximum Power Dissipation               | $P_D$                | Note 2.     | mW   |

- Either or both input voltages should not exceed  $V_{CC}$  or  $V_{EE}$ .
- Power dissipation must be considered to ensure maximum junction temperature ( $T_J$ ) is not exceeded** (see power dissipation performance characteristic, Figure 2). See applications section for further information.

## DC ELECTRICAL CHARACTERISTICS ( $V_{CC} = +15$ V, $V_{EE} = -15$ V, $T_A = 25^\circ\text{C}$ , unless otherwise noted.)

| Characteristics  | Figure   | Symbol   | Min                            | Typ  | Max                               | Unit                         |
|--|----------|--|--------------------------------|--|-----------------------------------|------------------------------|
| Input Offset Voltage ( $R_S = 50 \Omega$ , $V_{CM} = 0$ V)<br>( $V_S = \pm 2.5$ V to $\pm 15$ V)<br>$T_A = +25^\circ\text{C}$<br>$T_A = -40^\circ$ to $+85^\circ\text{C}$  | 3        | $ V_{IO} $   | –                              | 0.5  | 4.0                               | mV                           |
| Input Offset Voltage Temperature Coefficient<br>( $R_S = 50 \Omega$ , $V_{CM} = 0$ V)<br>$T_A = -40^\circ$ to $+85^\circ\text{C}$  |          | $\Delta V_{IO}/\Delta T$   | –                              | 2.0  | –                                 | $\mu\text{V}/^\circ\text{C}$ |
| Input Bias Current ( $V_{CM} = 0$ V)<br>$T_A = +25^\circ\text{C}$<br>$T_A = -40^\circ$ to $+85^\circ\text{C}$  | 4, 5     | $I_{IB}$   | –                              | 100  | 500                               | nA                           |
| Input Offset Current ( $V_{CM} = 0$ V)<br>$T_A = +25^\circ\text{C}$<br>$T_A = -40^\circ$ to $+85^\circ\text{C}$  |          | $ I_{IO} $   | –                              | 5.0  | 70                                | nA                           |
| Common Mode Input Voltage Range  | 6        | $V_{ICR}$  | -13                            | -14<br>+14   | 13                                | V                            |
| Large Signal Voltage Gain ( $V_O = -10$ V to $+10$ V)<br>( $T_A = +25^\circ\text{C}$ )<br>$R_L = 100 \Omega$<br>$R_L = 600 \Omega$<br>( $T_A = -40^\circ$ to $+85^\circ\text{C}$ )<br>$R_L = 600 \Omega$   | 7        | $A_{VOL}$  | 25<br>50<br>25                 | –<br>200<br>–                                      | –<br>–<br>–                       | kV/V                         |
| Output Voltage Swing ( $V_{ID} = \pm 1.0$ V)<br>( $V_{CC} = +15$ V, $V_{EE} = -15$ V)<br>$R_L = 100 \Omega$<br>$R_L = 100 \Omega$<br>$R_L = 600 \Omega$<br>$R_L = 600 \Omega$<br>( $V_{CC} = +2.5$ V, $V_{EE} = -2.5$ V)<br>$R_L = 100 \Omega$<br>$R_L = 100 \Omega$ | 8, 9, 10 | $V_{O+}$<br>$V_{O-}$<br>$V_{O+}$<br>$V_{O-}$<br>$V_{O+}$<br>$V_{O-}$ | 10<br>–<br>13<br>–<br>1.2<br>– | +11.7<br>-11.7<br>+13.8<br>-13.8<br>+1.66<br>-1.74 | –<br>-10<br>–<br>-13<br>–<br>-1.2 | V                            |
| Common Mode Rejection ( $V_{in} = \pm 13$ V)   | 11       | CMR  | 80                             | 116  | –                                 | dB                           |
| Power Supply Rejection<br>( $V_{CC}/V_{EE} = +15$ V/-15 V, +5.0 V/-15 V, +15 V/-5.0 V)   | 12       | PSR  | 80                             | 120  | –                                 | dB                           |

## MC33076

### DC ELECTRICAL CHARACTERISTICS ( $V_{CC} = +15\text{ V}$ , $V_{EE} = -15\text{ V}$ , $T_A = 25^\circ\text{C}$ , unless otherwise noted.)

| Characteristics   | Figure | Symbol   | Min      | Typ          | Max        | Unit |
|---|--------|----------|----------|--------------|------------|------|
| Output Short Circuit Current ( $V_{ID} = \pm 1.0\text{ V}$ Output to Gnd)<br>( $V_{CC} = +15\text{ V}$ , $V_{EE} = -15\text{ V}$ )<br>Source<br>Sink<br>( $V_{CC} = +2.5\text{ V}$ , $V_{EE} = -2.5\text{ V}$ )<br>Source<br>Sink | 13, 14 | $I_{SC}$ | 190<br>– | +250<br>–280 | –<br>–215  | mA   |
| Power Supply Current per Amplifier ( $V_O = 0\text{ V}$ )<br>( $V_S = \pm 2.5\text{ V}$ to $\pm 15\text{ V}$ )<br>$T_A = +25^\circ\text{C}$<br>$T_A = -40^\circ$ to $+85^\circ\text{C}$   | 15     | $I_D$    | –<br>–   | 2.2<br>–     | 2.8<br>3.3 | mA   |

### AC ELECTRICAL CHARACTERISTICS ( $V_{CC} = +15\text{ V}$ , $V_{EE} = -15\text{ V}$ , $T_A = 25^\circ\text{C}$ , unless otherwise noted.)

| Characteristics   | Figure | Symbol   | Min         | Typ                      | Max         | Unit                   |
|---|--------|----------|-------------|--------------------------|-------------|------------------------|
| Slew Rate ( $V_{in} = -10\text{ V}$ to $+10\text{ V}$ , $R_L = 100\ \Omega$ , $C_L = 100\text{ pF}$ , $A_V = 1.0$ )   | 16     | SR       | 1.2         | 2.6                      | –           | V/ $\mu\text{s}$       |
| Gain Bandwidth Product ( $f = 20\text{ kHz}$ )  | 17     | GBW      | 4.0         | 7.4                      | –           | MHz                    |
| Unity Gain Bandwidth (Open Loop) ( $R_L = 600\ \Omega$ , $C_L = 0\text{ pF}$ )  | –      | BW       | –           | 3.5                      | –           | MHz                    |
| Gain Margin ( $R_L = 600\ \Omega$ , $C_L = 0\text{ pF}$ )   | 20, 21 | $A_m$    | –           | 15                       | –           | dB                     |
| Phase Margin ( $R_L = 600\ \Omega$ , $C_L = 0\text{ pF}$ )  | 20, 21 | $\phi_m$ | –           | 52                       | –           | Deg                    |
| Channel Separation ( $f = 100\text{ Hz}$ to $20\text{ kHz}$ )   | 22     | CS       | –           | –120                     | –           | dB                     |
| Power Bandwidth ( $V_O = 20\text{ V}_{pp}$ , $R_L = 600\ \Omega$ , THD $\leq 1\%$ )   | –      | $BW_p$   | –           | 32                       | –           | kHz                    |
| Total Harmonic Distortion ( $R_L = 600\ \Omega$ , $V_O = 2.0\text{ V}_{pp}$ , $A_V = 1.0$ )<br>$f = 1.0\text{ kHz}$<br>$f = 10\text{ kHz}$<br>$f = 20\text{ kHz}$ | 23     | THD      | –<br>–<br>– | 0.0027<br>0.011<br>0.022 | –<br>–<br>– | %                      |
| Open Loop Output Impedance ( $V_O = 0\text{ V}$ , $f = 2.5\text{ MHz}$ , $A_V = 10$ )   | 24     | $ Z_O $  | –           | 75                       | –           | $\Omega$               |
| Differential Input Resistance ( $V_{CM} = 0\text{ V}$ )   | –      | $R_{in}$ | –           | 200                      | –           | k $\Omega$             |
| Differential Input Capacitance ( $V_{CM} = 0\text{ V}$ )  | –      | $C_{in}$ | –           | 10                       | –           | pF                     |
| Equivalent Input Noise Voltage ( $R_S = 100\ \Omega$ )<br>$f = 10\text{ Hz}$<br>$f = 1.0\text{ kHz}$  | 25     | $e_n$    | –<br>–      | 7.5<br>5.0               | –           | nV/ $\sqrt{\text{Hz}}$ |
| Equivalent Input Noise Current<br>$f = 10\text{ Hz}$<br>$f = 1.0\text{ kHz}$  | –      | $i_n$    | –<br>–      | 0.33<br>0.15             | –           | pA/ $\sqrt{\text{Hz}}$ |

# MC33076

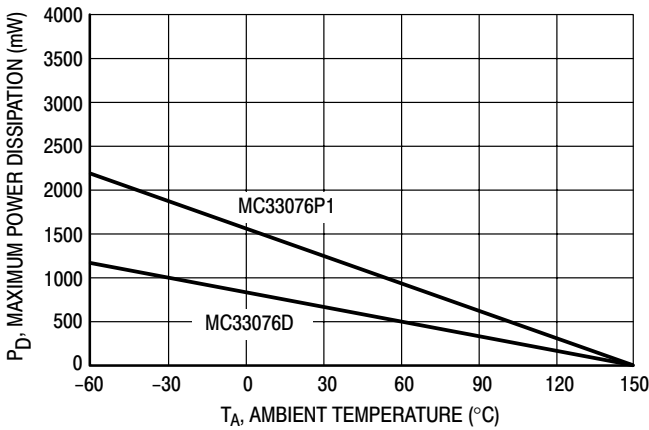


Figure 2. Maximum Power Dissipation versus Temperature

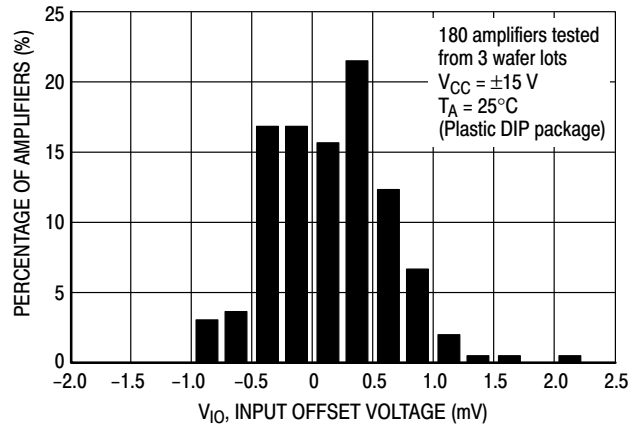


Figure 3. Distribution of Input Offset Voltage

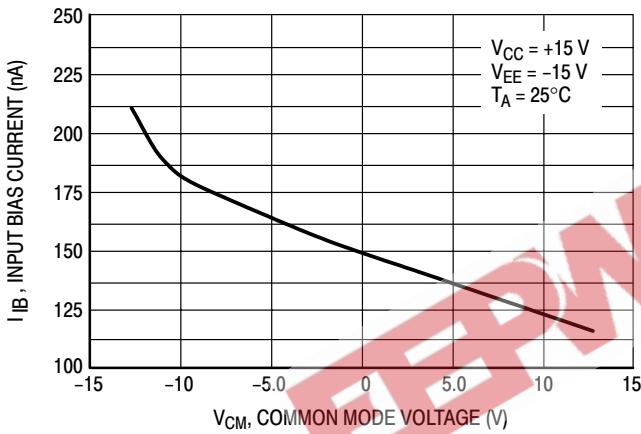


Figure 4. Input Bias Current versus Common Mode Voltage

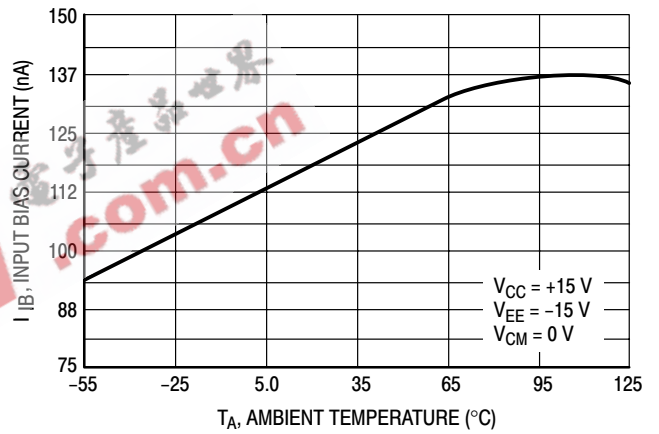


Figure 5. Input Bias Current versus Temperature

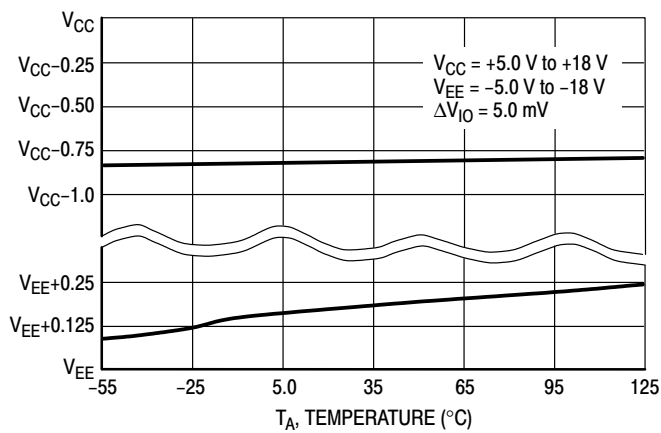


Figure 6. Input Common Mode Voltage Range versus Temperature

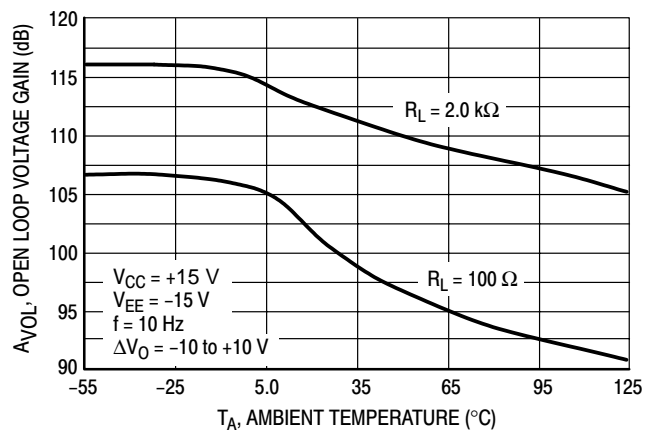
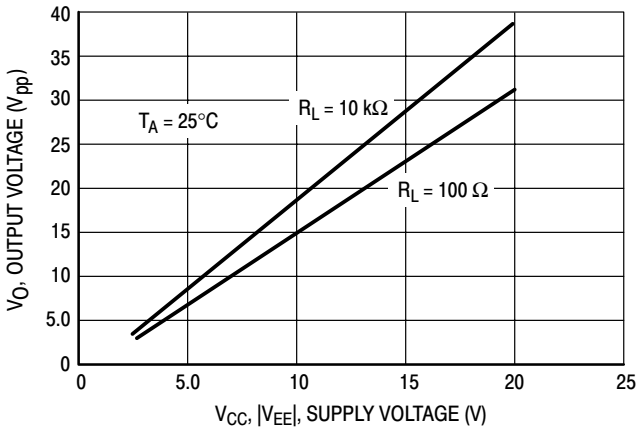
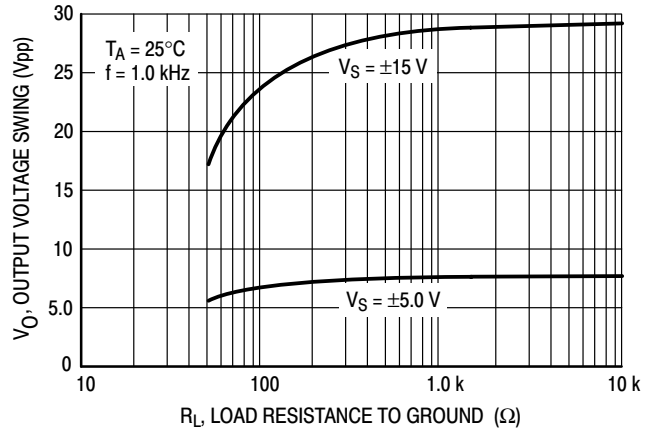


Figure 7. Open Loop Voltage Gain versus Temperature

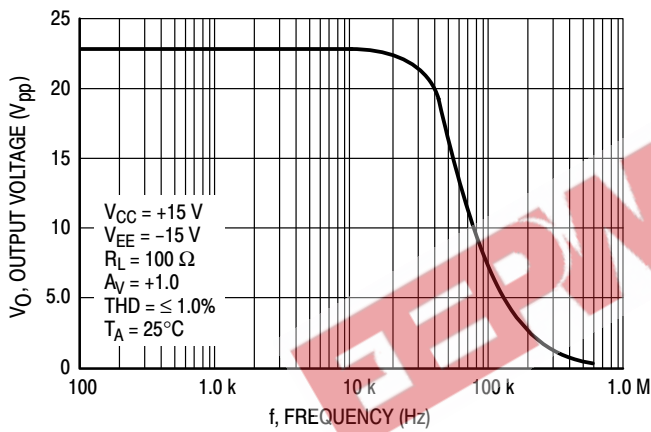
# MC33076



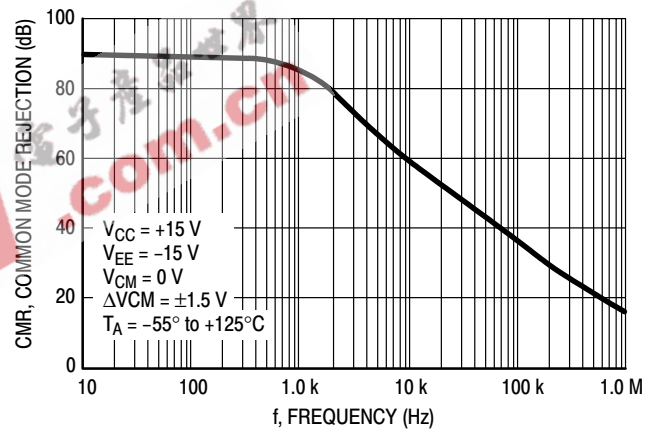
**Figure 8. Output Voltage Swing versus Supply Voltage**



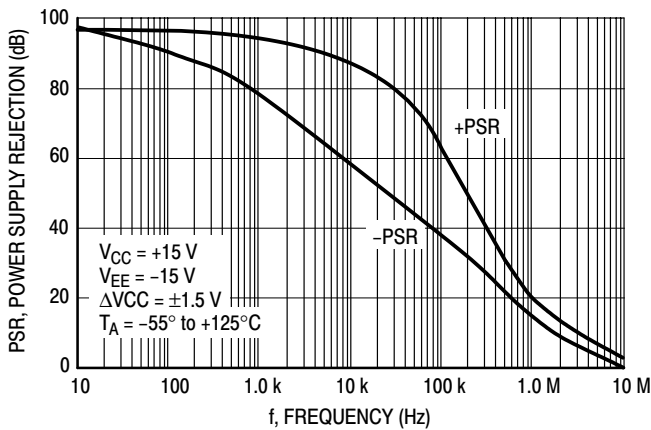
**Figure 9. Maximum Peak-to-Peak Output Voltage Swing versus Load Resistance**



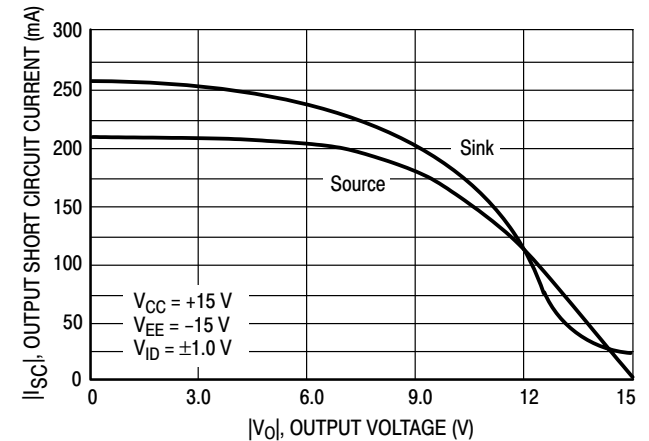
**Figure 10. Output Voltage versus Frequency**



**Figure 11. Common Mode Rejection versus Frequency Over Temperature**

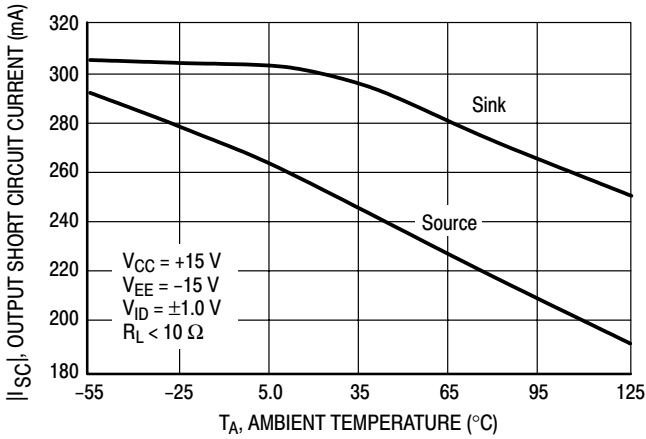


**Figure 12. Power Supply Rejection versus Frequency Over Temperature**

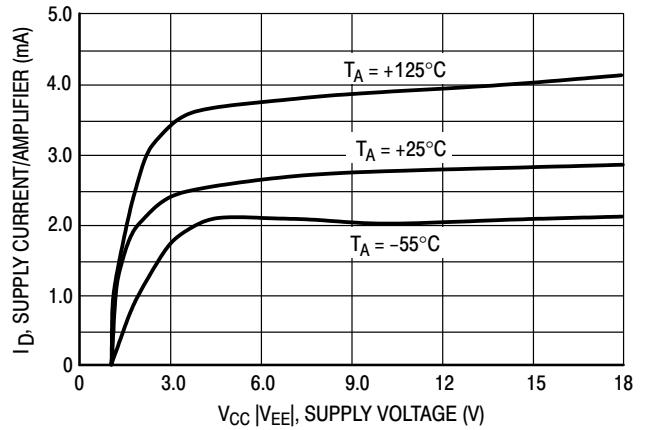


**Figure 13. Output Short Circuit Current versus Output Voltage**

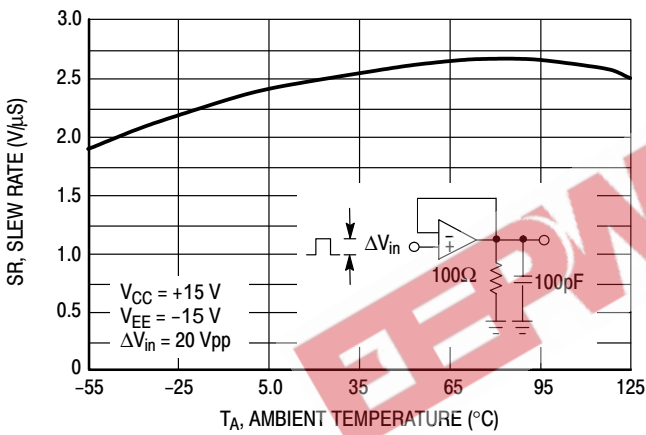
# MC33076



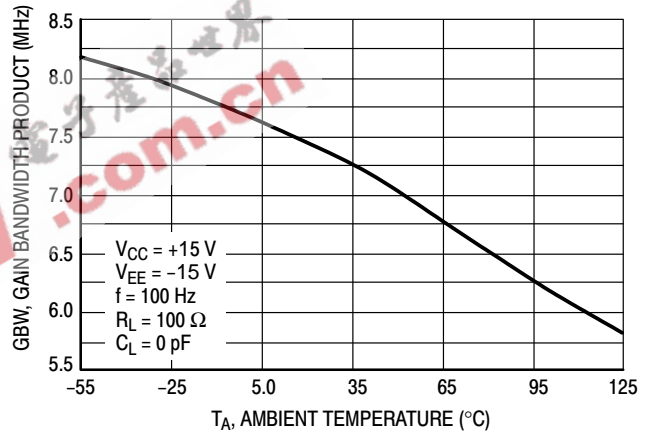
**Figure 14. Output Short Circuit Current versus Temperature**



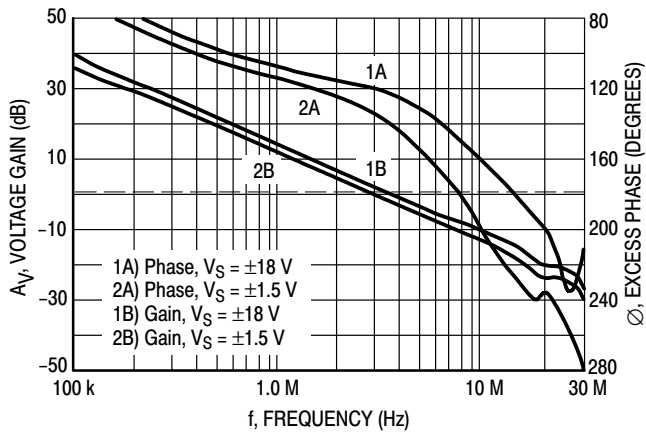
**Figure 15. Supply Current versus Supply Voltage with No Load**



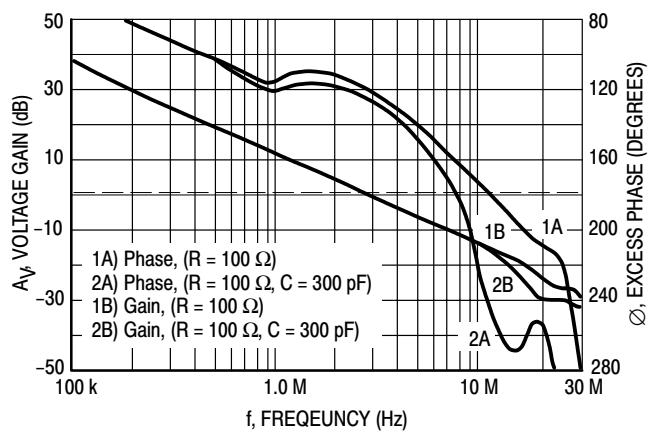
**Figure 16. Slew Rate versus Temperature**



**Figure 17. Gain Bandwidth Product versus Temperature**

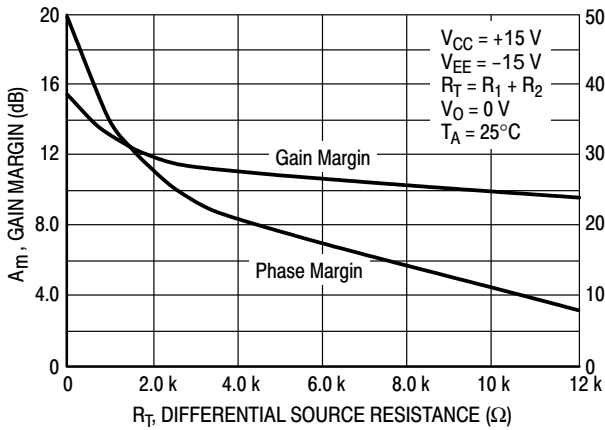


**Figure 18. Voltage Gain and Phase versus Frequency**

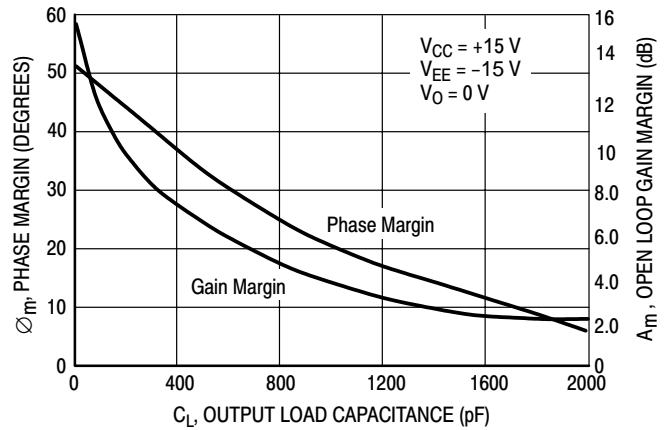


**Figure 19. Voltage Gain and Phase versus Frequency**

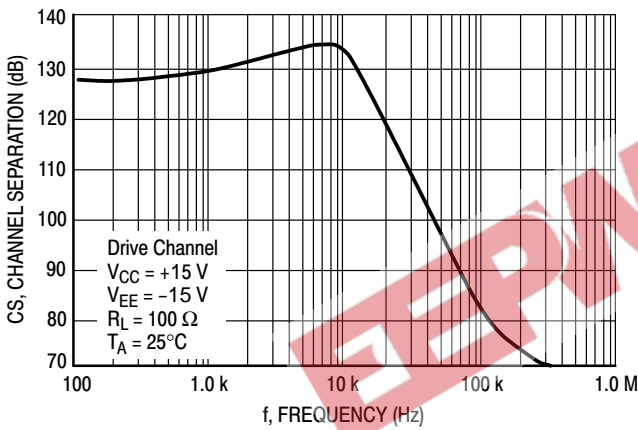
# MC33076



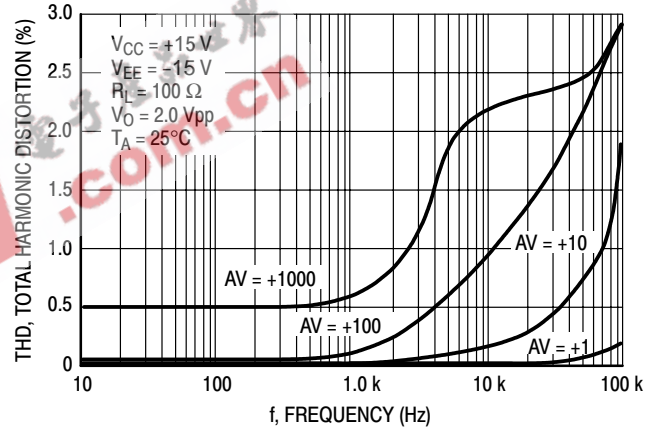
**Figure 20. Phase Margin and Gain Margin versus Differential Source Resistance**



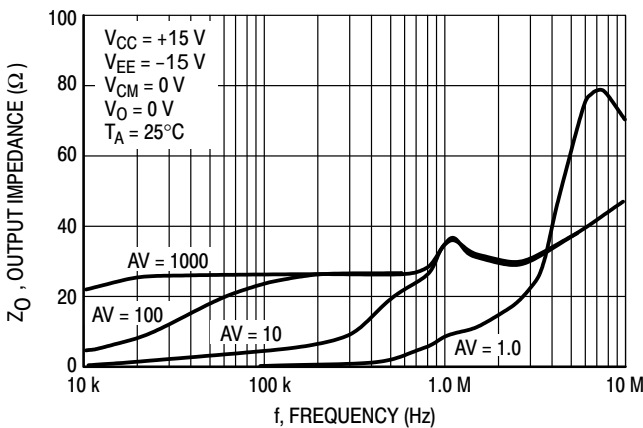
**Figure 21. Open Loop Gain Margin and Phase Margin versus Output Load Capacitance**



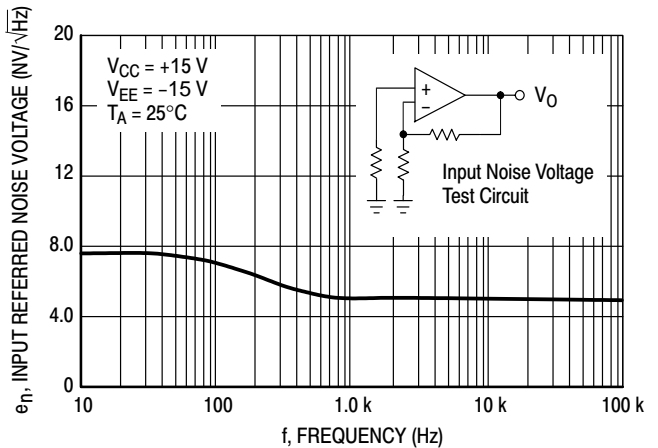
**Figure 22. Channel Separation versus Frequency**



**Figure 23. Total Harmonic Distortion versus Frequency**



**Figure 24. Output Impedance versus Frequency**



**Figure 25. Input Referred Noise Voltage versus Frequency**

## MC33076

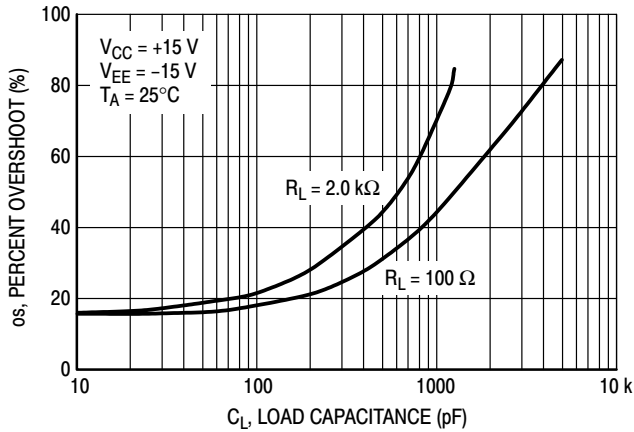


Figure 26. Percent Overshoot versus Load Capacitance

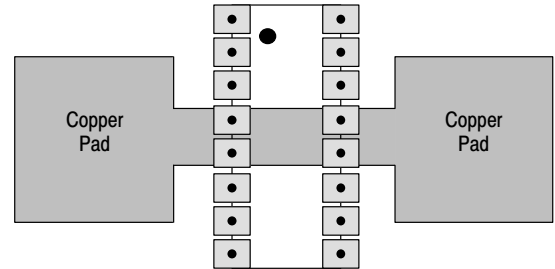


Figure 27. PC Board Heatsink Example

### APPLICATIONS INFORMATION

The MC33076 dual operational amplifier is available in the standard 8-pin plastic dual-in-line (DIP) and surface mount packages, and also in a 16-pin batwing power package. To enhance the power dissipation capability of the power package, Pins 4, 5, 12, and 13 are tied together on the leadframe, giving it an ambient thermal resistance of

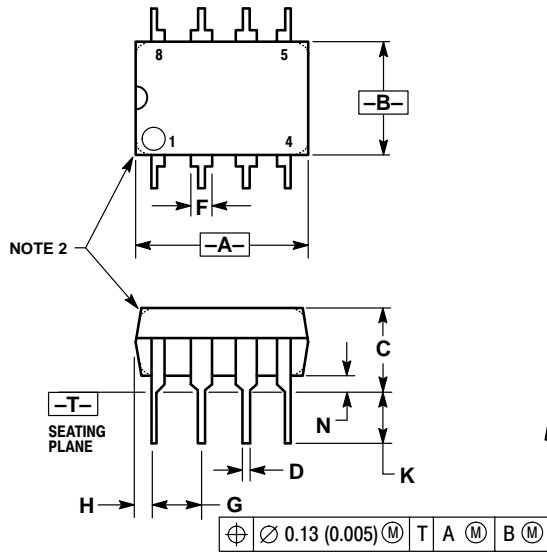
$52^\circ\text{C/W}$  typically, in still air. The junction-to-ambient thermal resistance ( $R_{\theta JA}$ ) can be decreased further by using a copper pad on the printed circuit board (as shown in Figure 27) to draw the heat away from the package. *Care must be taken not to exceed the maximum junction temperature or damage to the device may occur.*



# MC33076

## PACKAGE DIMENSIONS

PDIP-8  
P1 SUFFIX  
CASE 626-05  
ISSUE L

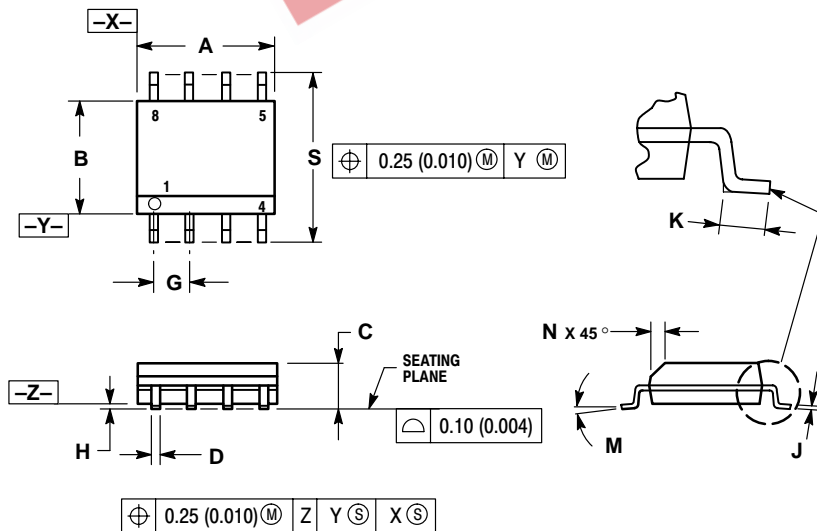


NOTES:

1. DIMENSION L TO CENTER OF LEAD WHEN FORMED PARALLEL.
2. PACKAGE CONTOUR OPTIONAL (ROUND OR SQUARE CORNERS).
3. DIMENSIONING AND TOLERANCING PER ANSI Y14.5M, 1982.

| DIM | MILLIMETERS |       | INCHES    |       |
|-----|-------------|-------|-----------|-------|
|     | MIN         | MAX   | MIN       | MAX   |
| A   | 9.40        | 10.16 | 0.370     | 0.400 |
| B   | 6.10        | 6.60  | 0.240     | 0.260 |
| C   | 3.94        | 4.45  | 0.155     | 0.175 |
| D   | 0.38        | 0.51  | 0.015     | 0.020 |
| F   | 1.02        | 1.78  | 0.040     | 0.070 |
| G   | 2.54 BSC    |       | 0.100 BSC |       |
| H   | 0.76        | 1.27  | 0.030     | 0.050 |
| J   | 0.20        | 0.30  | 0.008     | 0.012 |
| K   | 2.92        | 3.43  | 0.115     | 0.135 |
| L   | 7.62 BSC    |       | 0.300 BSC |       |
| M   | ---         | 10°   | ---       | 10°   |
| N   | 0.76        | 1.01  | 0.030     | 0.040 |

SO-8  
D SUFFIX  
CASE 751-07  
ISSUE W



NOTES:

1. DIMENSIONING AND TOLERANCING PER ANSI Y14.5M, 1982.
2. CONTROLLING DIMENSION: MILLIMETER.
3. DIMENSION A AND B DO NOT INCLUDE MOLD PROTRUSION.
4. MAXIMUM MOLD PROTRUSION 0.15 (0.006) PER SIDE.
5. DIMENSION D DOES NOT INCLUDE DAMBAR PROTRUSION. ALLOWABLE DAMBAR PROTRUSION SHALL BE 0.127 (0.005) TOTAL IN EXCESS OF THE D DIMENSION AT MAXIMUM MATERIAL CONDITION.

| DIM | MILLIMETERS |      | INCHES    |       |
|-----|-------------|------|-----------|-------|
|     | MIN         | MAX  | MIN       | MAX   |
| A   | 4.80        | 5.00 | 0.189     | 0.197 |
| B   | 3.80        | 4.00 | 0.150     | 0.157 |
| C   | 1.35        | 1.75 | 0.053     | 0.069 |
| D   | 0.33        | 0.51 | 0.013     | 0.020 |
| G   | 1.27 BSC    |      | 0.050 BSC |       |
| H   | 0.10        | 0.25 | 0.004     | 0.010 |
| J   | 0.19        | 0.25 | 0.007     | 0.010 |
| K   | 0.40        | 1.27 | 0.016     | 0.050 |
| M   | 0°          | 8°   | 0°        | 8°    |
| N   | 0.25        | 0.50 | 0.010     | 0.020 |
| S   | 5.80        | 6.20 | 0.228     | 0.244 |


Notes

EEPW 电子产品世界  
.com.cn

Notes

EEPW 电子产品世界  
.com.cn

EEPW 电子產品世界 .com.cn

**ON Semiconductor** and  are trademarks of Semiconductor Components Industries, LLC (SCILLC). SCILLC reserves the right to make changes without further notice to any products herein. SCILLC makes no warranty, representation or guarantee regarding the suitability of its products for any particular purpose, nor does SCILLC assume any liability arising out of the application or use of any product or circuit, and specifically disclaims any and all liability, including without limitation special, consequential or incidental damages. "Typical" parameters which may be provided in SCILLC data sheets and/or specifications can and do vary in different applications and actual performance may vary over time. All operating parameters, including "Typicals" must be validated for each customer application by customer's technical experts. SCILLC does not convey any license under its patent rights nor the rights of others. SCILLC products are not designed, intended, or authorized for use as components in systems intended for surgical implant into the body, or other applications intended to support or sustain life, or for any other application in which the failure of the SCILLC product could create a situation where personal injury or death may occur. Should Buyer purchase or use SCILLC products for any such unintended or unauthorized application, Buyer shall indemnify and hold SCILLC and its officers, employees, subsidiaries, affiliates, and distributors harmless against all claims, costs, damages, and expenses, and reasonable attorney fees arising out of, directly or indirectly, any claim of personal injury or death associated with such unintended or unauthorized use, even if such claim alleges that SCILLC was negligent regarding the design or manufacture of the part. SCILLC is an Equal Opportunity/Affirmative Action Employer.

## PUBLICATION ORDERING INFORMATION

### NORTH AMERICA Literature Fulfillment:

Literature Distribution Center for ON Semiconductor  
 P.O. Box 5163, Denver, Colorado 80217 USA  
**Phone:** 303-675-2175 or 800-344-3860 Toll Free USA/Canada  
**Fax:** 303-675-2176 or 800-344-3867 Toll Free USA/Canada  
**Email:** ONlit@hibbertco.com  
 Fax Response Line: 303-675-2167 or 800-344-3810 Toll Free USA/Canada

**N. American Technical Support:** 800-282-9855 Toll Free USA/Canada

**EUROPE:** LDC for ON Semiconductor – European Support

**German Phone:** (+1) 303-308-7140 (Mon–Fri 2:30pm to 7:00pm CET)  
**Email:** ONlit-german@hibbertco.com  
**French Phone:** (+1) 303-308-7141 (Mon–Fri 2:00pm to 7:00pm CET)  
**Email:** ONlit-french@hibbertco.com  
**English Phone:** (+1) 303-308-7142 (Mon–Fri 12:00pm to 5:00pm GMT)  
**Email:** ONlit@hibbertco.com

**EUROPEAN TOLL-FREE ACCESS\*: 00-800-4422-3781**

\*Available from Germany, France, Italy, UK, Ireland

### CENTRAL/SOUTH AMERICA:

**Spanish Phone:** 303-308-7143 (Mon–Fri 8:00am to 5:00pm MST)  
**Email:** ONlit-spanish@hibbertco.com  
**Toll-Free from Mexico:** Dial 01-800-288-2872 for Access –  
 then Dial 866-297-9322

**ASIA/PACIFIC:** LDC for ON Semiconductor – Asia Support

**Phone:** 303-675-2121 (Tue–Fri 9:00am to 1:00pm, Hong Kong Time)  
**Toll Free from Hong Kong & Singapore:**  
**001-800-4422-3781**  
**Email:** ONlit-asia@hibbertco.com

**JAPAN:** ON Semiconductor, Japan Customer Focus Center  
 4-32-1 Nishi-Gotanda, Shinagawa-ku, Tokyo, Japan 141-0031  
**Phone:** 81-3-5740-2700  
**Email:** r14525@onsemi.com

**ON Semiconductor Website:** <http://onsemi.com>

For additional information, please contact your local Sales Representative.