



Sleep-Mode™ Two-State, Micropower Operational Amplifier

The MC33102 dual operational amplifier is an innovative design concept employing Sleep-Mode technology. Sleep-Mode amplifiers have two separate states, a sleepmode and an awakemode. In sleepmode, the amplifier is active and waiting for an input signal. When a signal is applied causing the amplifier to source or sink 160 μA (typically) to the load, it will automatically switch to the awakemode which offers higher slew rate, gain bandwidth, and drive capability.

- Two States: "Sleepmode" (Micropower) and "Awakemode" (High Performance)
- Switches from Sleepmode to Awakemode in 4.0 μs when Output Current Exceeds the Threshold Current ($R_L = 600 \Omega$)
- Independent Sleepmode Function for Each Op Amp
- Standard Pinouts – No Additional Pins or Components Required
- Sleepmode State – Can Be Used in the Low Current Idle State as a Fully Functional Micropower Amplifier
- Automatic Return to Sleepmode when Output Current Drops Below Threshold
- No Deadband/Crossover Distortion; as Low as 1.0 Hz in the Awakemode
- Drop-in Replacement for Many Other Dual Op Amps
- ESD Clamps on Inputs Increase Reliability without Affecting Device Operation

Sleep-Mode is a trademark of Motorola, Inc.

TYPICAL SLEEPMODE/AWAKEMODE PERFORMANCE

Characteristic	Sleepmode (Typical)	Awakemode (Typical)	Unit
Low Current Drain	45	750	μA
Low Input Offset Voltage	0.15	0.15	mV
High Output Current Capability	0.15	50	mA
Low T.C. of Input Offset Voltage	1.0	1.0	$\mu\text{V}/^\circ\text{C}$
High Gain Bandwidth (@ 20 kHz)	0.33	4.6	MHz
High Slew Rate	0.16	1.7	$\text{V}/\mu\text{s}$
Low Noise (@ 1.0 kHz)	28	9.0	$\text{nV}/\sqrt{\text{Hz}}$

MAXIMUM RATINGS

Ratings	Symbol	Value	Unit
Supply Voltage (V_{CC} to V_{EE})	V_S	+36	V
Input Differential Voltage Range	V_{IDR}	(Note 1)	V
Input Voltage Range	V_{IR}	(Note 2)	V
Output Short Circuit Duration (Note 2)	t_{SC}	(Note 2)	sec
Maximum Junction Temperature	T_J	+150	$^\circ\text{C}$
Storage Temperature	T_{stg}	-65 to +150	$^\circ\text{C}$
Maximum Power Dissipation	P_D	(Note 2)	mW

NOTES: 1. Either or both input voltages should not exceed V_{CC} or V_{EE} .
2. Power dissipation must be considered to ensure maximum junction temperature (T_J) is not exceeded (refer to Figure 1).

MC33102

DUAL SLEEP-MODE OPERATIONAL AMPLIFIER

SEMICONDUCTOR TECHNICAL DATA

D SUFFIX
PLASTIC PACKAGE
CASE 751
(SO-8)



P SUFFIX
PLASTIC PACKAGE
CASE 626

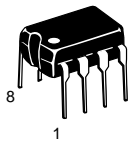

PIN CONNECTIONS

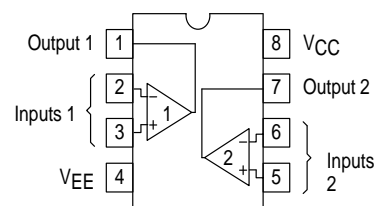

(Dual, Top View)

ORDERING INFORMATION

Device	Operating Temperature Range	Package
MC33102D	$T_A = -40^\circ$ to $+85^\circ\text{C}$	SO-8
MC33102P		Plastic DIP

MC33102

Simplified Block Diagram

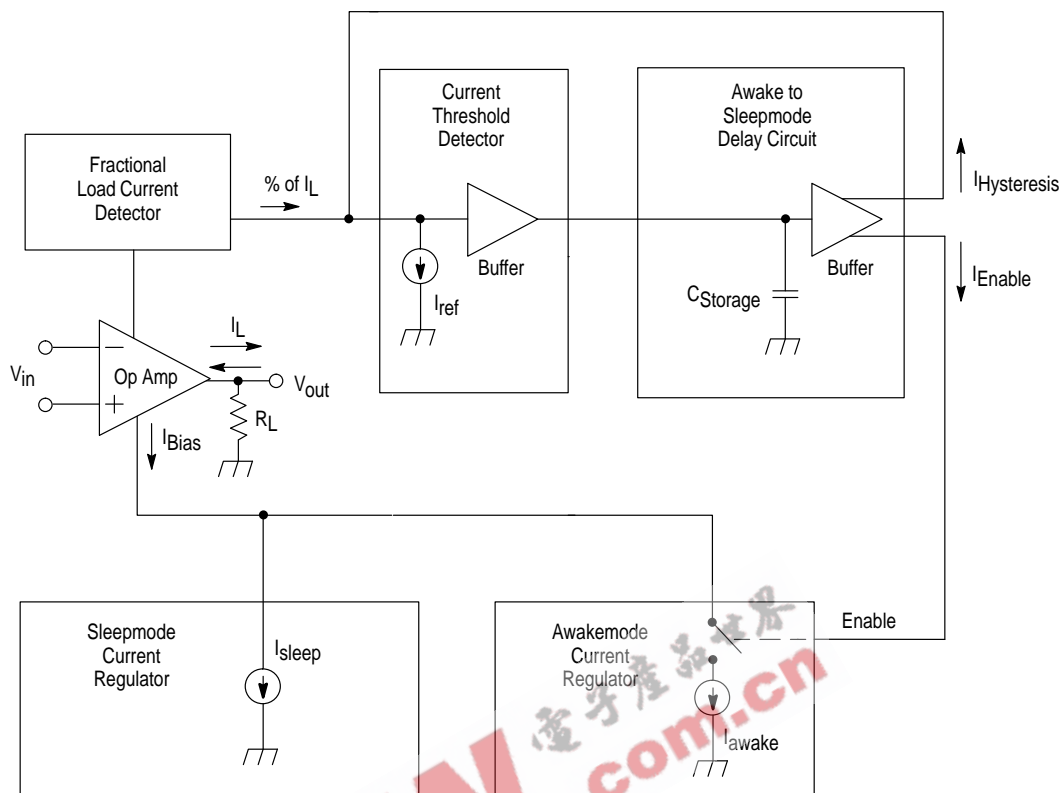

DC ELECTRICAL CHARACTERISTICS (V_{CC} = +15 V, V_{EE} = -15 V, T_A = 25°C, unless otherwise noted.)

Characteristics	Figure	Symbol	Min	Typ	Max	Unit
Input Offset Voltage (R _S = 50 Ω, V _{CM} = 0 V, V _O = 0 V) Sleepmode T _A = +25°C T _A = -40° to +85°C Awakemode T _A = +25°C T _A = -40° to +85°C	2	V _{IO}	—	0.15	2.0	mV
Input Offset Voltage Temperature Coefficient (R _S = 50 Ω, V _{CM} = 0 V, V _O = 0 V) T _A = -40° to +85°C (Sleepmode and Awakemode)	3	ΔV _{IO} /ΔT	—	1.0	—	μV/°C
Input Bias Current (V _{CM} = 0 V, V _O = 0 V) Sleepmode T _A = +25°C T _A = -40° to +85°C Awakemode T _A = +25°C T _A = -40° to +85°C	4, 6	I _{IB}	—	8.0	50	nA
Input Offset Current (V _{CM} = 0 V, V _O = 0 V) Sleepmode T _A = +25°C T _A = -40° to +85°C Awakemode T _A = +25°C T _A = -40° to +85°C	—	I _{IO}	—	0.5	5.0	nA

MC33102

DC ELECTRICAL CHARACTERISTICS ($V_{CC} = +15\text{ V}$, $V_{EE} = -15\text{ V}$, $T_A = 25^\circ\text{C}$, unless otherwise noted.)

Characteristics	Figure	Symbol	Min	Typ	Max	Unit
Common Mode Input Voltage Range ($\Delta V_{IO} = 5.0\text{ mV}$, $V_O = 0\text{ V}$) Sleepmode and Awakemode	5	V_{ICR}	-13 —	-14.8 +14.2	— +13	V
Large Signal Voltage Gain Sleepmode ($R_L = 1.0\text{ M}\Omega$) $T_A = +25^\circ\text{C}$ $T_A = -40^\circ$ to $+85^\circ\text{C}$ Awakemode ($V_O = \pm 10\text{ V}$, $R_L = 600\ \Omega$) $T_A = +25^\circ\text{C}$ $T_A = -40^\circ$ to $+85^\circ\text{C}$	7	A_{VOL}	25 15	200 —	— —	kV/V
Output Voltage Swing ($V_{ID} = \pm 1.0\text{ V}$) Sleepmode ($V_{CC} = +15\text{ V}$, $V_{EE} = -15\text{ V}$) $R_L = 1.0\text{ M}\Omega$ $R_L = 1.0\text{ M}\Omega$ Awakemode ($V_{CC} = +15\text{ V}$, $V_{EE} = -15\text{ V}$) $R_L = 600\ \Omega$ $R_L = 600\ \Omega$ $R_L = 2.0\text{ k}\Omega$ $R_L = 2.0\text{ k}\Omega$ Awakemode ($V_{CC} = +2.5\text{ V}$, $V_{EE} = -2.5\text{ V}$) $R_L = 600\ \Omega$ $R_L = 600\ \Omega$	8, 9, 10	V_{O+} V_{O-} V_{O+} V_{O-} V_{O+} V_{O-} V_{O+} V_{O-}	+13.5 — +12.5 — +13.3 — +1.1 —	+14.2 -14.2 +13.6 -13.6 +14 -14 +1.6 -1.6	— -13.5 — -12.5 — -13.3 — -1.1	V V
Common Mode Rejection ($V_{CM} = \pm 13\text{ V}$) Sleepmode and Awakemode	11	CMR	80	90	—	dB
Power Supply Rejection ($V_{CC}/V_{EE} = +15\text{ V}/-15\text{ V}$, $5.0\text{ V}/-15\text{ V}$, $+15\text{ V}/-5.0\text{ V}$) Sleepmode and Awakemode	12	PSR	80	100	—	dB
Output Transition Current Sleepmode to Awakemode (Source/Sink) ($V_S = \pm 15\text{ V}$) ($V_S = \pm 2.5\text{ V}$) Awakemode to Sleepmode (Source/Sink) ($V_S = \pm 15\text{ V}$) ($V_S = \pm 2.5\text{ V}$)	13, 14	$ I_{TH1} $ $ I_{TH2} $	200 250 — —	160 200 142 180	— — 90 140	μA
Output Short Circuit Current (Awakemode) ($V_{ID} = \pm 1.0\text{ V}$, Output to Ground) Source Sink	15, 16	$ I_{SC} $	50 50	110 110	— —	mA
Power Supply Current (per Amplifier) ($A_{CL} = 1$, $V_O = 0\text{ V}$) Sleepmode ($V_S = \pm 15\text{ V}$) $T_A = +25^\circ\text{C}$ $T_A = -40^\circ$ to $+85^\circ\text{C}$ Sleepmode ($V_S = \pm 2.5\text{ V}$) $T_A = +25^\circ\text{C}$ $T_A = -40^\circ$ to $+85^\circ\text{C}$ Awakemode ($V_S = \pm 15\text{ V}$) $T_A = +25^\circ\text{C}$ $T_A = -40^\circ$ to $+85^\circ\text{C}$	17	I_D	— — — — — —	45 48 38 42 750 800	65 70 65 — 800 900	μA

MC33102

AC ELECTRICAL CHARACTERISTICS ($V_{CC} = +15\text{ V}$, $V_{EE} = -15\text{ V}$, $T_A = 25^\circ\text{C}$, unless otherwise noted.)

Characteristics	Figure	Symbol	Min	Typ	Max	Unit
Slew Rate ($V_{in} = -5.0\text{ V}$ to $+5.0\text{ V}$, $C_L = 50\text{ pF}$, $A_V = 1.0$) Sleepmode ($R_L = 1.0\text{ M}\Omega$) Awakemode ($R_L = 600\ \Omega$)	18	SR	0.10 1.0	0.16 1.7	— —	V/ μs
Gain Bandwidth Product Sleepmode ($f = 10\text{ kHz}$) Awakemode ($f = 20\text{ kHz}$)	19	GBW	0.25 3.5	0.33 4.6	— —	MHz
Sleepmode to Awakemode Transition Time ($A_{CL} = 0.1$, $V_{in} = 0\text{ V}$ to $+5.0\text{ V}$) $R_L = 600\ \Omega$ $R_L = 10\text{ k}\Omega$	20, 21	t_{tr1}	— —	4.0 15	— —	μs
Awakemode to Sleepmode Transition Time	22	t_{tr2}	—	1.5	—	sec
Unity Gain Frequency (Open Loop) Sleepmode ($R_L = 100\text{ k}\Omega$, $C_L = 0\text{ pF}$) Awakemode ($R_L = 600\ \Omega$, $C_L = 0\text{ pF}$)		f_U	— —	200 2500	— —	kHz
Gain Margin Sleepmode ($R_L = 100\text{ k}\Omega$, $C_L = 0\text{ pF}$) Awakemode ($R_L = 600\ \Omega$, $C_L = 0\text{ pF}$)	23, 25	A_M	— —	13 12	— —	dB
Phase Margin Sleepmode ($R_L = 100\text{ k}\Omega$, $C_L = 0\text{ pF}$) Awakemode ($R_L = 600\ \Omega$, $C_L = 0\text{ pF}$)	24, 26	ϕ_M	— —	60 60	— —	Degrees
Channel Separation ($f = 100\text{ Hz}$ to 20 kHz) Sleepmode and Awakemode	29	CS	—	120	—	dB
Power Bandwidth (Awakemode) ($V_O = 10\text{ V}_{pp}$, $R_L = 100\text{ k}\Omega$, $\text{THD} \leq 1\%$)		BW _P	—	20	—	kHz
Total Harmonic Distortion ($V_O = 2.0\text{ V}_{pp}$, $A_V = 1.0$) Awakemode ($R_L = 600\ \Omega$) $f = 1.0\text{ kHz}$ $f = 10\text{ kHz}$ $f = 20\text{ kHz}$	30	THD	— — —	0.005 0.016 0.031	— — —	%
DC Output Impedance ($V_O = 0\text{ V}$, $A_V = 10$, $I_Q = 10\ \mu\text{A}$) Sleepmode Awakemode	31	R_O	— —	1.0 k 96	— —	Ω
Differential Input Resistance ($V_{CM} = 0\text{ V}$) Sleepmode Awakemode		R_{in}	— —	1.3 0.17	— —	$\text{M}\Omega$
Differential Input Capacitance ($V_{CM} = 0\text{ V}$) Sleepmode Awakemode		C_{in}	— —	0.4 4.0	— —	pF
Equivalent Input Noise Voltage ($f = 1.0\text{ kHz}$, $R_S = 100\ \Omega$) Sleepmode Awakemode	32	e_n	— —	28 9.0	— —	$\text{nV}/\sqrt{\text{Hz}}$
Equivalent Input Noise Current ($f = 1.0\text{ kHz}$) Sleepmode Awakemode	33	i_n	— —	0.01 0.05	— —	$\text{pA}/\sqrt{\text{Hz}}$

MC33102

Figure 1. Maximum Power Dissipation versus Temperature

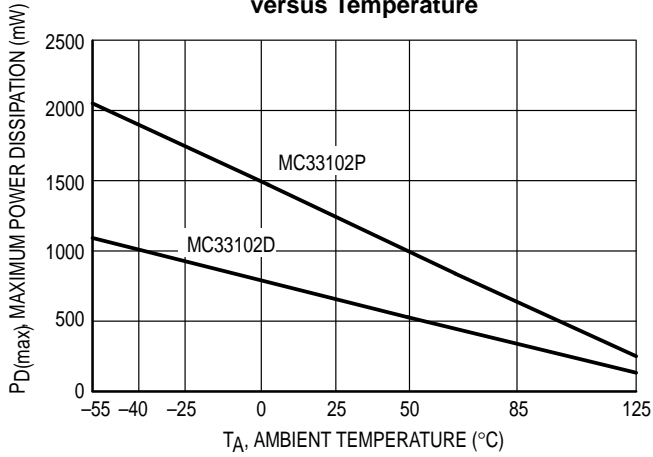

Figure 2. Distribution of Input Offset Voltage (MC33102D Package)

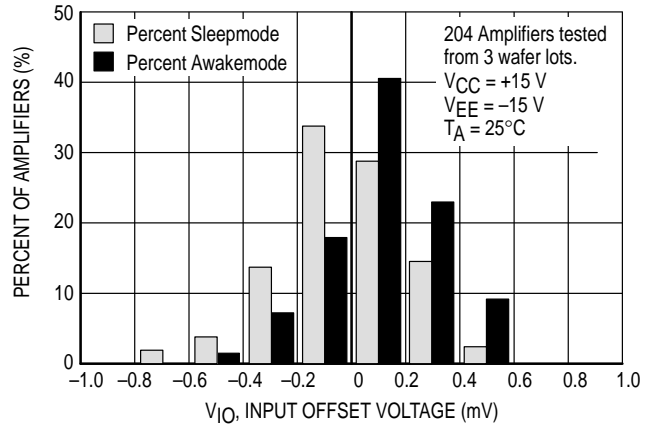

Figure 3. Input Offset Voltage Temperature Coefficient Distribution (MC33102D Package)

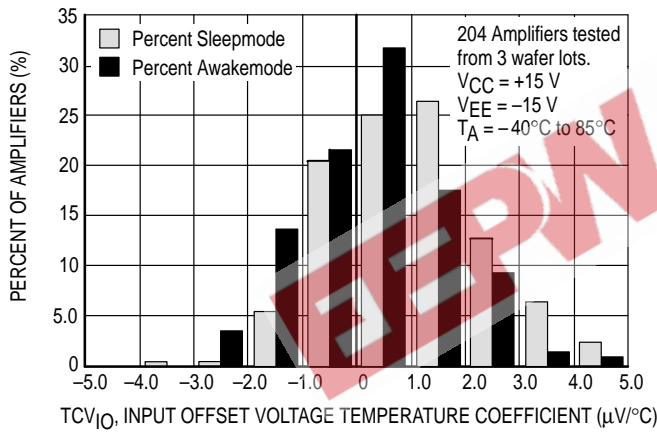

Figure 4. Input Bias Current versus Common Mode Input Voltage

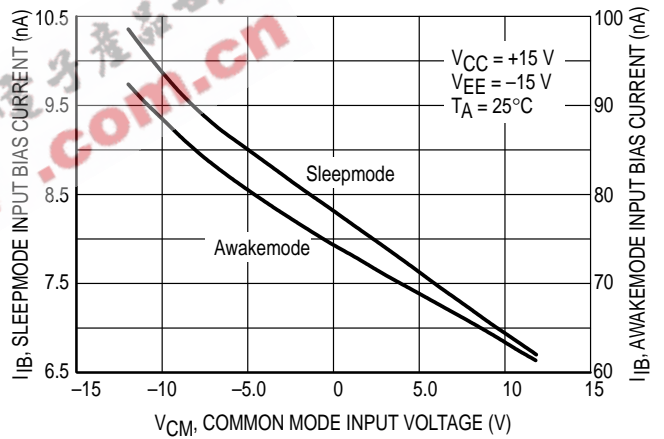

Figure 5. Input Common Mode Voltage Range versus Temperature

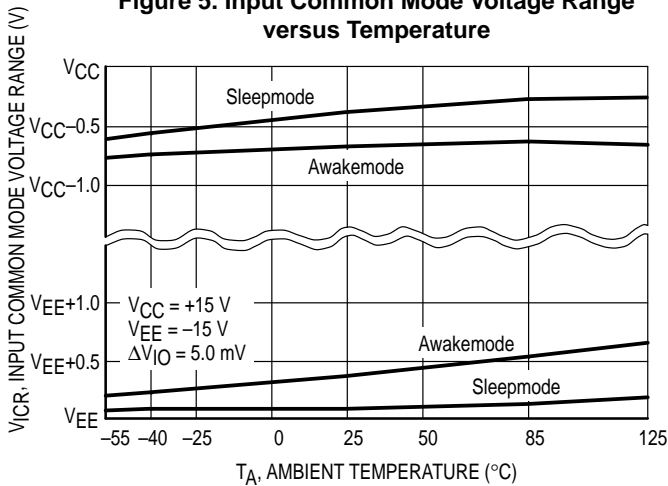

Figure 6. Input Bias Current versus Temperature

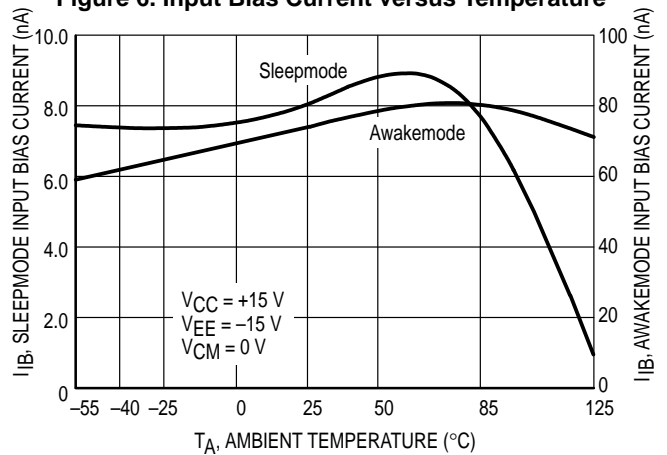

Figure 7. Open Loop Voltage Gain versus Temperature

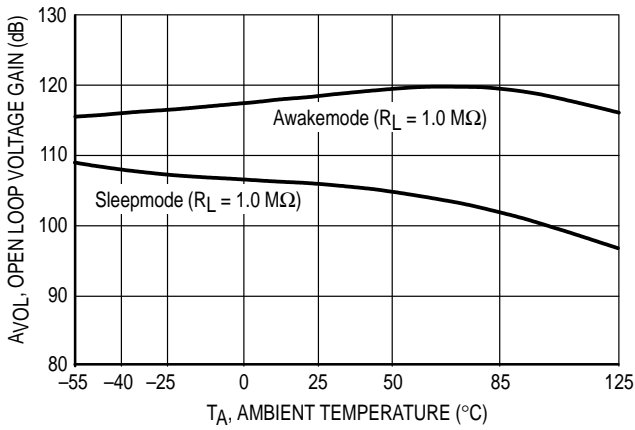

Figure 8. Output Voltage Swing versus Supply Voltage

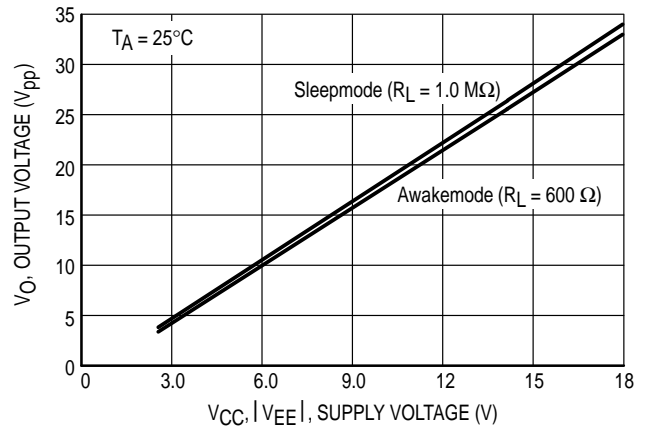

Figure 9. Output Voltage versus Frequency

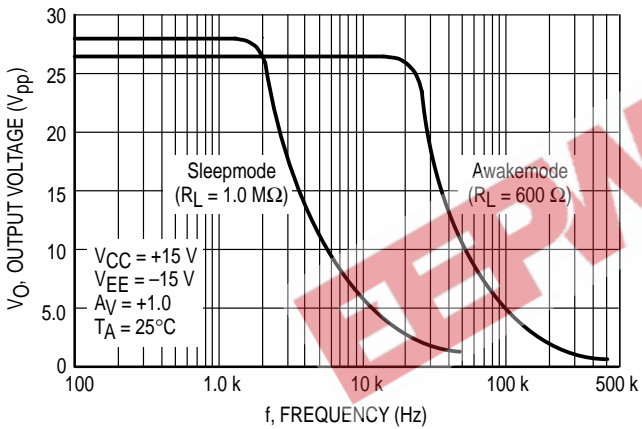

Figure 10. Maximum Peak-to-Peak Output Voltage Swing versus Load Resistance

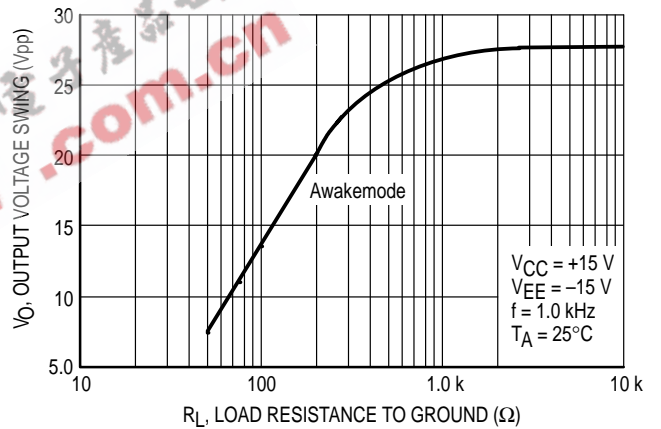

Figure 11. Common Mode Rejection versus Frequency

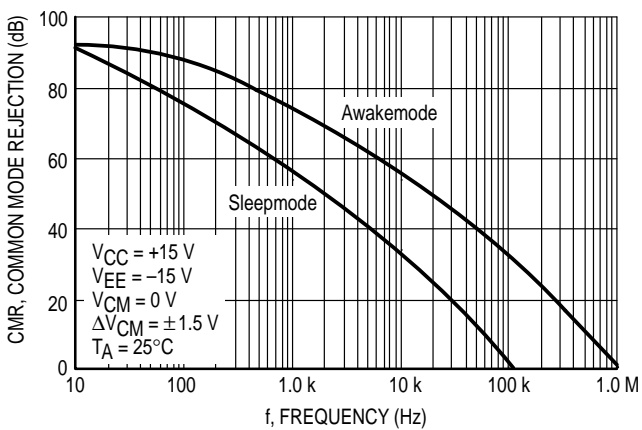
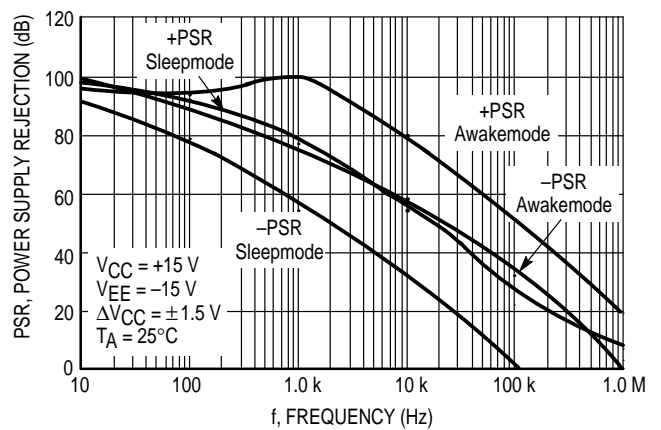

Figure 12. Power Supply Rejection versus Frequency



MC33102

Figure 13. Sleepmode to Awakemode Current Threshold versus Supply Voltage

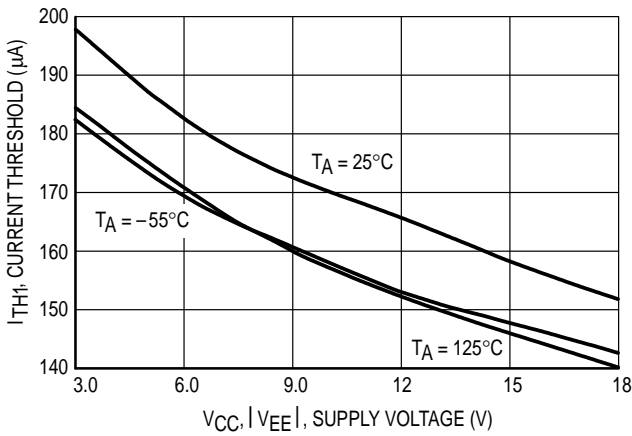

Figure 14. Awakemode to Sleepmode Current Threshold versus Supply Voltage

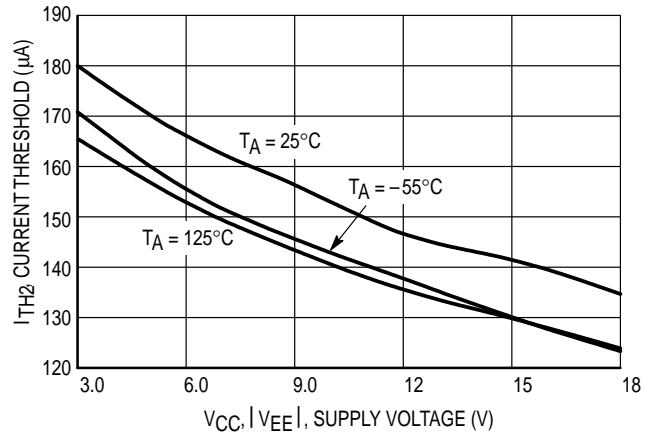

Figure 15. Output Short Circuit Current versus Output Voltage

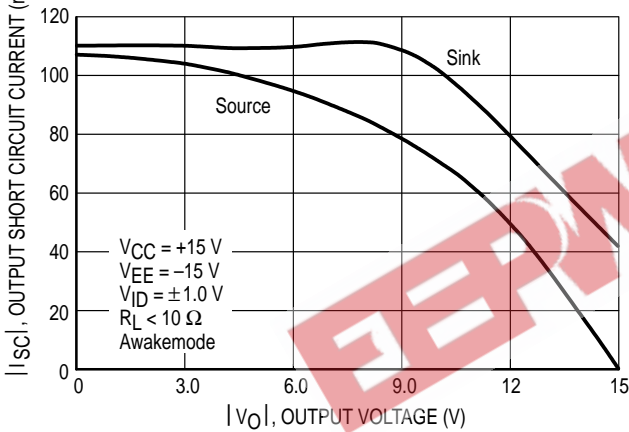

Figure 16. Output Short Circuit Current versus Temperature

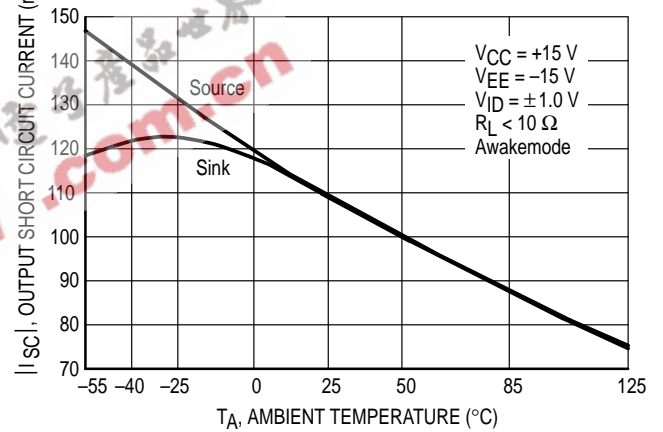

Figure 17. Power Supply Current Per Amplifier versus Temperature

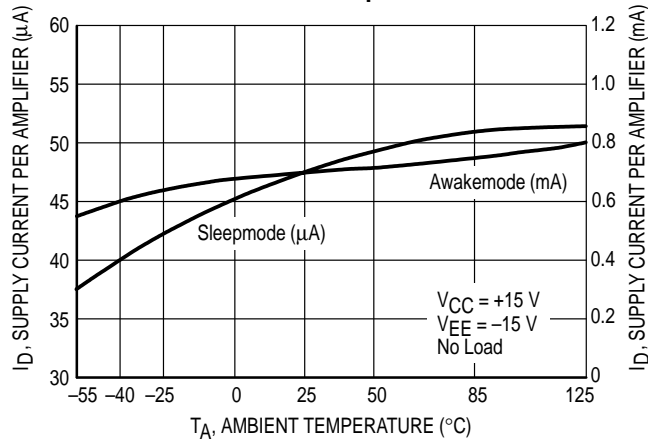

Figure 18. Slew Rate versus Temperature

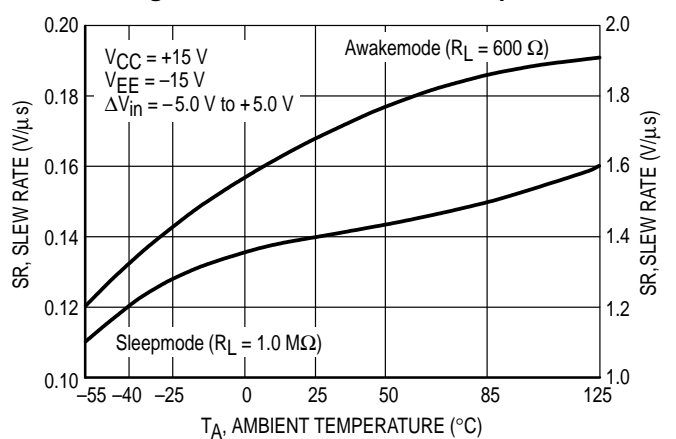

Figure 19. Gain Bandwidth Product versus Temperature

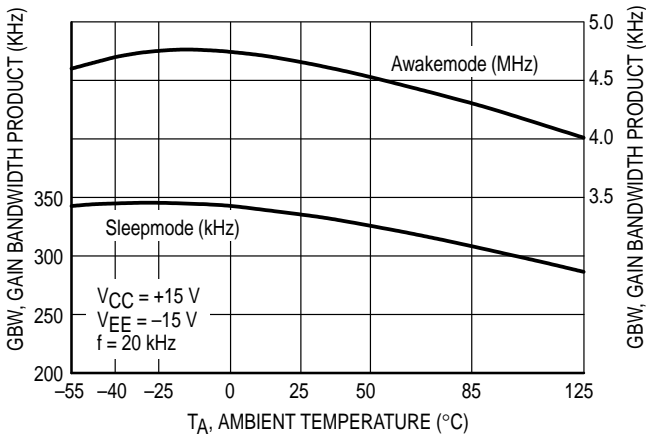

Figure 20. Sleepmode to Awakemode Transition Time

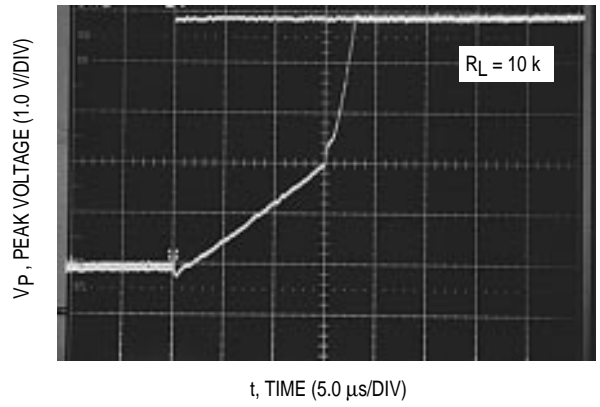

Figure 21. Sleepmode to Awakemode Transition Time

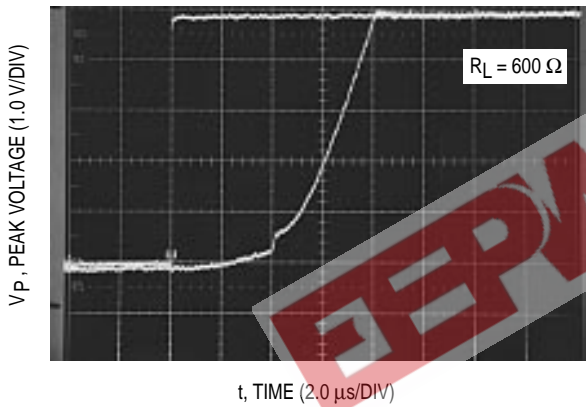

Figure 22. Awakemode to Sleepmode Transition Time versus Supply Voltage

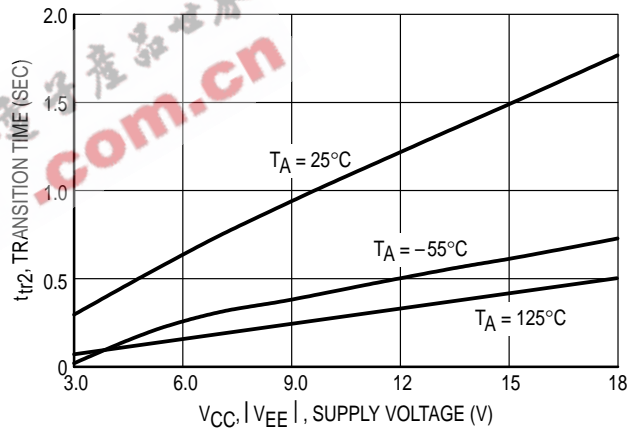

Figure 23. Gain Margin versus Differential Source Resistance

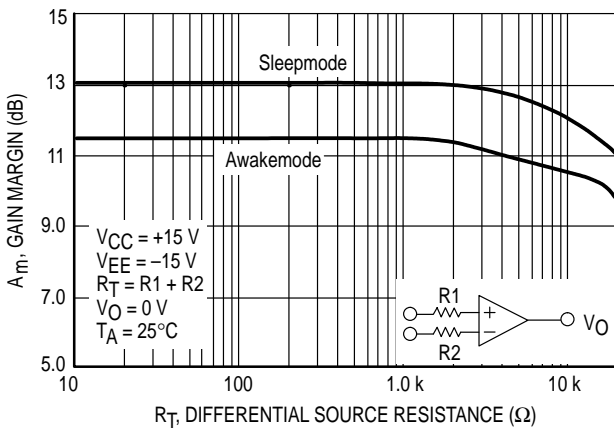

Figure 24. Phase Margin versus Differential Source Resistance

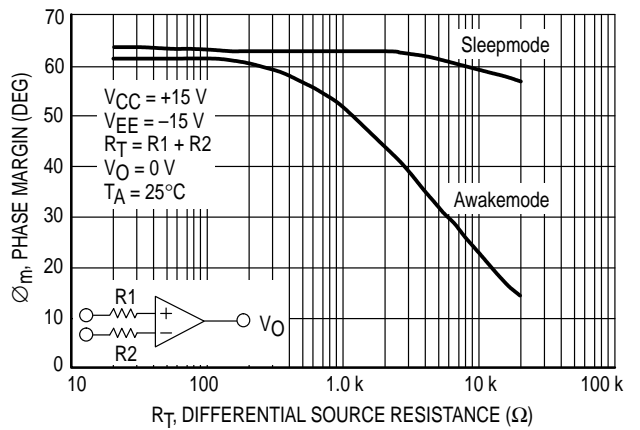

Figure 25. Open Loop Gain Margin versus Output Load Capacitance

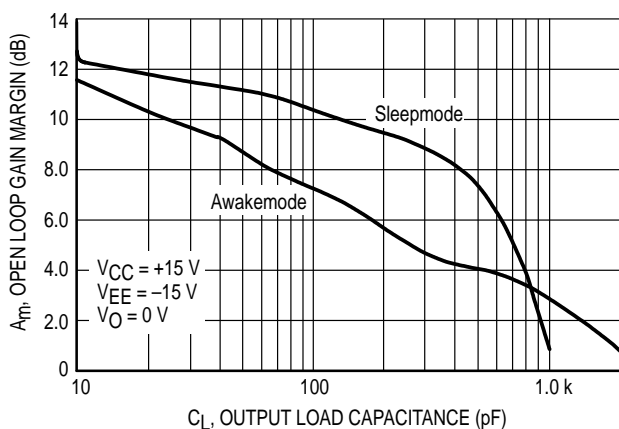

Figure 26. Phase Margin versus Output Load Capacitance

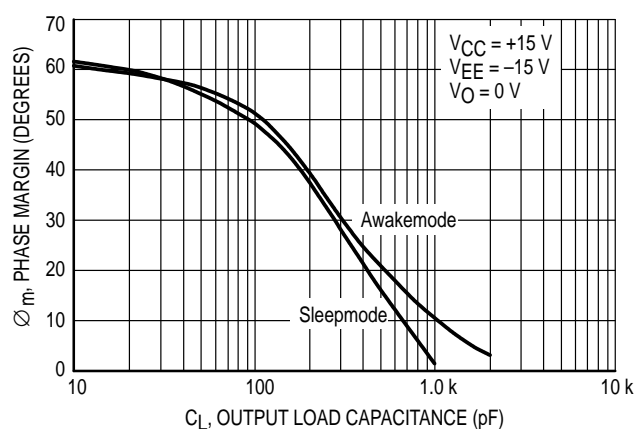

Figure 27. Sleepmode Voltage Gain and Phase versus Frequency

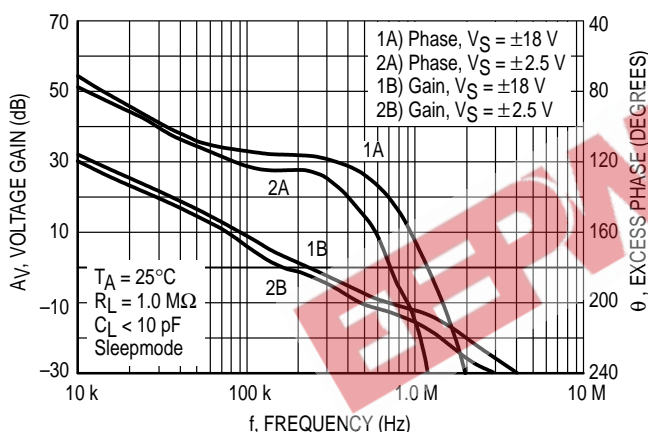

Figure 28. Awakemode Voltage Gain and Phase versus Frequency

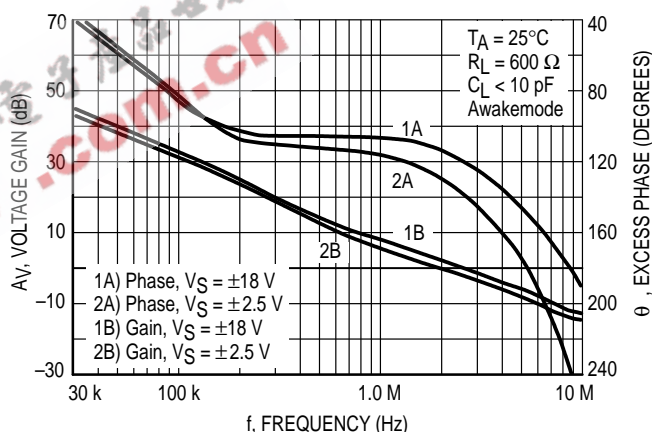

Figure 29. Channel Separation versus Frequency

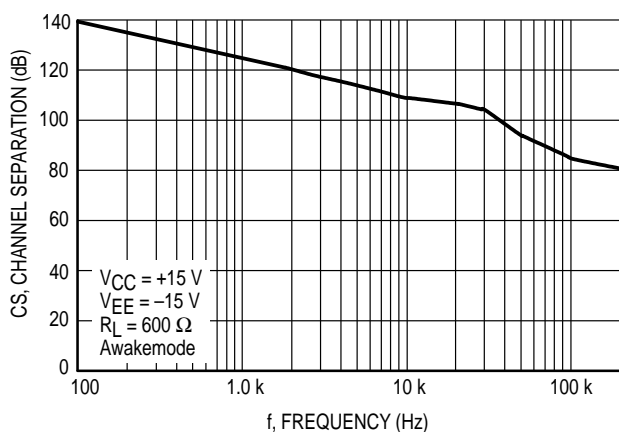
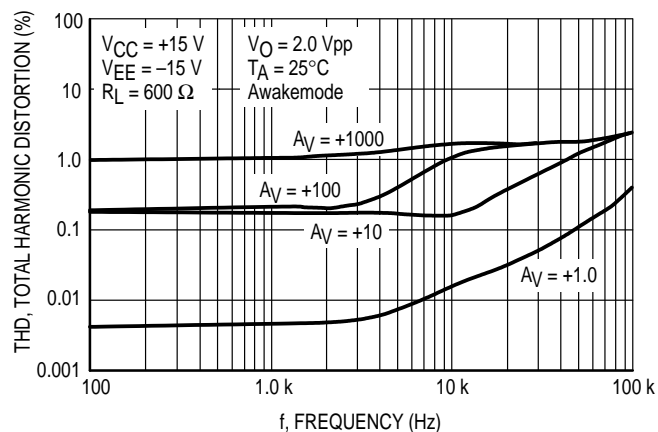

Figure 30. Total Harmonic Distortion versus Frequency



MC33102

Figure 31. Awakemode Output Impedance versus Frequency

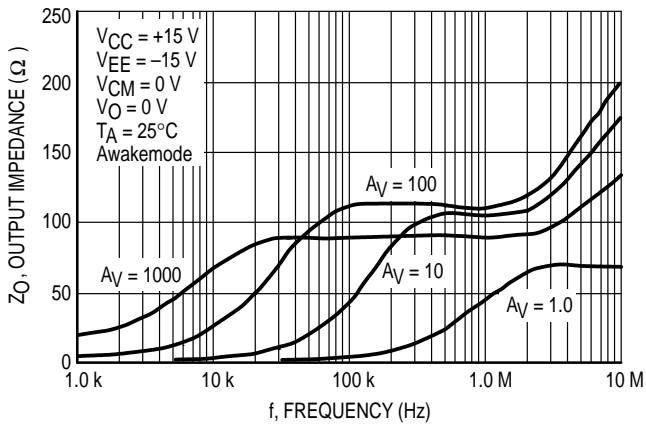

Figure 32. Input Referred Noise Voltage versus Frequency

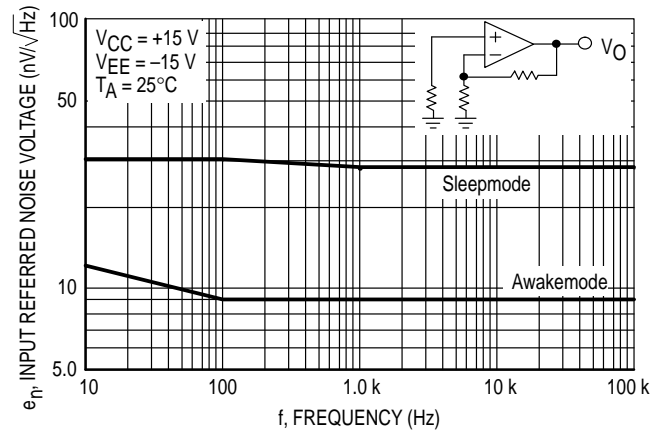

Figure 33. Current Noise versus Frequency

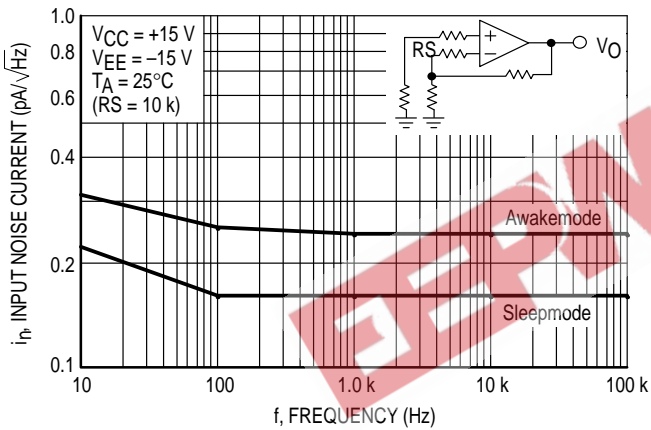

Figure 34. Percent Overshoot versus Load Capacitance

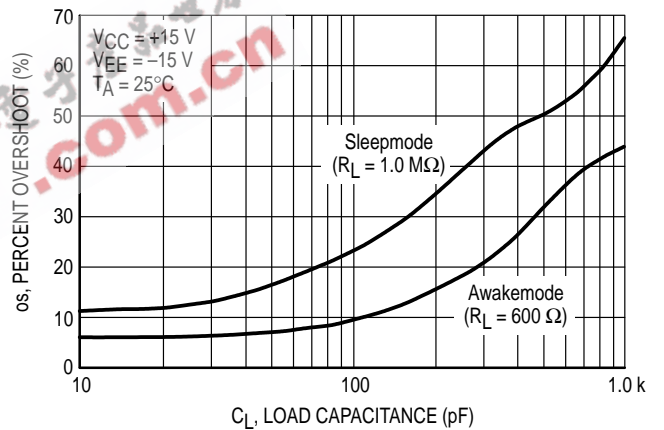

Figure 35. Sleepmode Large Signal Transient Response

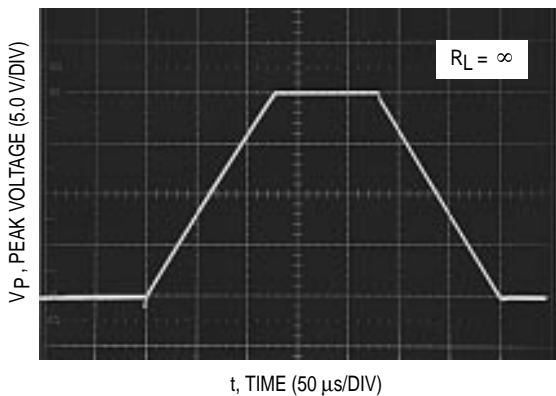
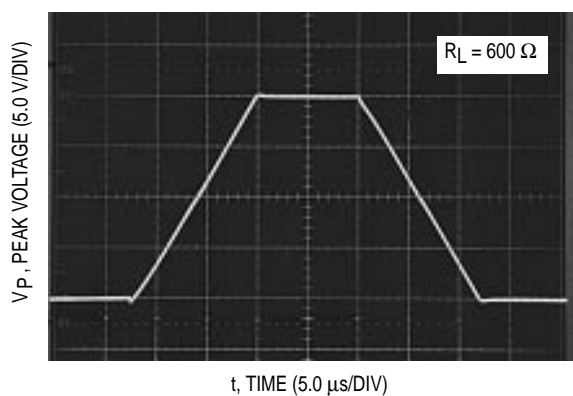

Figure 36. Awakemode Large Signal Transient Response



MC33102

Figure 37. Sleepmode Small Signal Transient Response

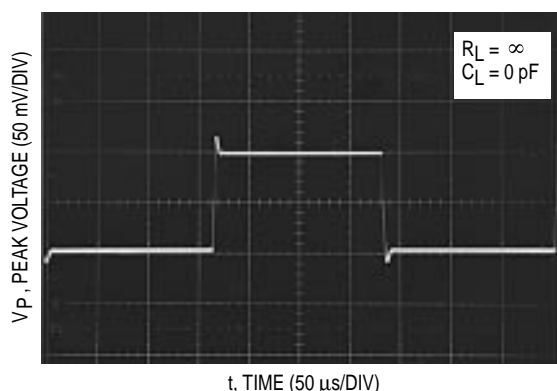
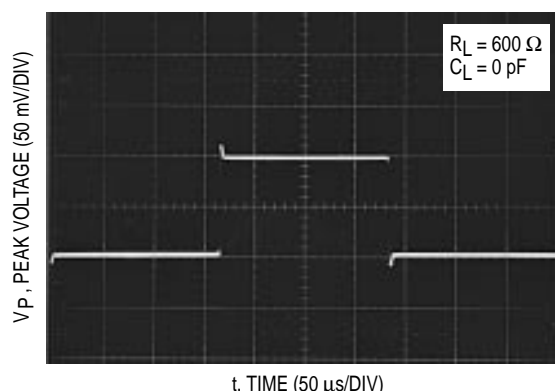

Figure 38. Awakemode Small Signal Transient Response



CIRCUIT INFORMATION

The MC33102 was designed primarily for applications where high performance (which requires higher current drain) is required only part of the time. The two-state feature of this op amp enables it to conserve power during idle times, yet be powered up and ready for an input signal. Possible applications include laptop computers, automotive, cordless phones, baby monitors, and battery operated test equipment. Although most applications will require low power consumption, this device can be used in any application where better efficiency and higher performance is needed.

The Sleep-Mode™ amplifier has two states; a sleepmode and an awakemode. In the sleepmode state, the amplifier is active and functions as a typical micropower op amp. When a signal is applied to the amplifier causing it to source or sink sufficient current (see Figure 13), the amplifier will automatically switch to the awakemode. See Figures 20 and 21 for transition times with 600 Ω and 10 kΩ loads.

The awakemode uses higher drain current to provide a high slew rate, gain bandwidth, and output current capability. In the awakemode, this amplifier can drive 27 V_{pp} into a 600 Ω load with $V_S = \pm 15$ V.

An internal delay circuit is used to prevent the amplifier from returning to the sleepmode at every zero crossing. This delay circuit also eliminates the crossover distortion commonly found in micropower amplifiers. This amplifier can process frequencies as low as 1.0 Hz without the amplifier returning to sleepmode, depending on the load.

The first stage PNP differential amplifier provides low noise performance in both the sleep and awake modes, and an all NPN output stage provides symmetrical source and sink AC frequency response.

APPLICATIONS INFORMATION

The MC33102 will begin to function at power supply voltages as low as $V_S = \pm 1.0$ V at room temperature. (At this voltage, the output voltage swing will be limited to a few hundred millivolts.) The input voltages must range between V_{CC} and V_{EE} supply voltages as shown in the maximum rating table. Specifically, **allowing the input to go more negative than 0.3 V below V_{EE} may cause product damage.** Also, exceeding the input common mode voltage range on either input may cause phase reversal, even if the inputs are between V_{CC} and V_{EE} .

When power is initially applied, the part may start to operate in the awakemode. This is because of the currents generated due to charging of internal capacitors. When this occurs and the sleepmode state is desired, the user will have to wait approximately 1.5 seconds before the device will switch back to the sleepmode. To prevent this from occurring, ramp the power supplies from 1.0 V to full supply. Notice that the device is more prone to switch into the awakemode when V_{EE} is adjusted than with a similar change in V_{CC} .

The amplifier is designed to switch from sleepmode to awakemode whenever the output current exceeds a preset

current threshold (I_{TH}) of approximately 160 μA. As a result, the output switching threshold voltage (V_{ST}) is controlled by the output loading resistance (R_L). This loading can be a load resistor, feedback resistors, or both. Then:

$$V_{ST} = (160 \mu A) \times R_L$$

Large valued load resistors require a large output voltage to switch, but reduce unwanted transitions to the awakemode. For instance, in cases where the amplifier is connected with a large closed loop gain (A_{CL}), the input offset voltage (V_{IO}) is multiplied by the gain at the output and could produce an output voltage exceeding V_{ST} with no input signal applied.

Small values of R_L allow rapid transition to the awakemode because most of the transition time is consumed slewing in the sleepmode until V_{ST} is reached (see Figures 20, 21). The output switching threshold voltage V_{ST} is higher for larger values of R_L , requiring the amplifier to slew longer in the slower sleepmode state before switching to the awakemode.

MC33102

The transition time (t_{tr1}) required to switch from sleep to awake mode is:

$$t_{tr1} = t_D = I_{TH} (R_L/SR_{\text{sleepmode}})$$

Where: t_D = Amplifier delay ($<1.0 \mu\text{s}$)
 I_{TH} = Output threshold current for more transition ($160 \mu\text{A}$)
 R_L = Load resistance
 $SR_{\text{sleepmode}}$ = Sleepmode slew rate ($0.16 \text{ V}/\mu\text{s}$)

Although typically $160 \mu\text{A}$, I_{TH} varies with supply voltage and temperature. In general, any current loading on the output which causes a current greater than I_{TH} to flow will switch the amplifier into the awakemode. This includes transition currents such as those generated by charging load capacitances. In fact, the maximum capacitance that can be driven while attempting to remain in the sleepmode is approximately 1000 pF .

$$\begin{aligned} C_{L(\text{max})} &= I_{TH}/SR_{\text{sleepmode}} \\ &= 160 \mu\text{A}/(0.16 \text{ V}/\mu\text{s}) \\ &= 1000 \text{ pF} \end{aligned}$$

Any electrical noise seen at the output of the MC33102 may also cause the device to transition to the awakemode. To

minimize this problem, a resistor may be added in series with the output of the device (inserted as close to the device as possible) to isolate the op amp from both parasitic and load capacitance.

The awakemode to sleepmode transition time is controlled by an internal delay circuit, which is necessary to prevent the amplifier from going to sleep during every zero crossing. This time is a function of supply voltage and temperature as shown in Figure 22.

Gain bandwidth product (GBW) in both modes is an important system design consideration when using a sleepmode amplifier. The amplifier has been designed to obtain the maximum GBW in both modes. "Smooth" AC transitions between modes with no noticeable change in the amplitude of the output voltage waveform will occur as long as the closed loop gains (A_{CL}) in both modes are substantially equal at the frequency of operation. For smooth AC transitions:

$$(A_{CL\text{sleepmode}}) (BW) < GBW_{\text{sleepmode}}$$

Where: $A_{CL\text{sleepmode}}$ = Closed loop gain in the sleepmode
 BW = The required system bandwidth or operating frequency

TESTING INFORMATION

To determine if the MC33102 is in the awakemode or the sleepmode, the power supply currents (I_{D+} and I_{D-}) must be measured. When the magnitude of **either** power supply current exceeds $400 \mu\text{A}$, the device is in the awakemode. When the magnitudes of both supply currents are less than $400 \mu\text{A}$, the device is in the sleepmode. Since the total supply current is typically ten times higher in the awakemode than the sleepmode, the two states are easily distinguishable.

The measured value of I_{D+} equals the I_D of both devices (for a dual op amp) plus the output source current of device A and the output source current of device B. Similarly, the measured value of I_{D-} is equal to the I_{D-} of both devices plus the output sink current of each device. I_{out} is the sum

of the currents caused by both the feedback loop and load resistance. The total I_{out} needs to be subtracted from the measured I_D to obtain the correct I_D of the dual op amp.

An accurate way to measure the awakemode I_{out} current on automatic test equipment is to remove the I_{out} current on both Channel A and B. Then measure the I_D values before the device goes back to the sleepmode state. The transition will take typically 1.5 seconds with $\pm 15 \text{ V}$ power supplies.

The large signal sleepmode testing in the characterization was accomplished with a $1.0 \text{ M}\Omega$ load resistor which ensured the device would remain in sleepmode despite large voltage swings.

MC33102

OUTLINE DIMENSIONS

D SUFFIX PLASTIC PACKAGE CASE 751-05 (SO-8) ISSUE R

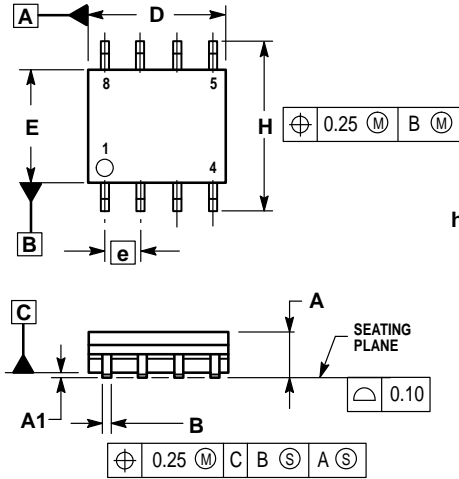

NOTES:

1. DIMENSIONING AND TOLERANCING PER ASME Y14.5M, 1994.
2. DIMENSIONS ARE IN MILLIMETERS.
3. DIMENSION D AND E DO NOT INCLUDE MOLD PROTRUSION.
4. MAXIMUM MOLD PROTRUSION 0.15 PER SIDE.
5. DIMENSION B DOES NOT INCLUDE MOLD PROTRUSION. ALLOWABLE DAMBAR PROTRUSION SHALL BE 0.127 TOTAL IN EXCESS OF THE B DIMENSION AT MAXIMUM MATERIAL CONDITION.

MILLIMETERS	
DIM	MIN MAX
A	1.35 1.75
A1	0.10 0.25
B	0.35 0.49
C	0.18 0.25
D	4.80 5.00
E	3.80 4.00
e	1.27 BSC
H	5.80 6.20
h	0.25 0.50
L	0.40 1.25
θ	0° 7°

P SUFFIX PLASTIC PACKAGE CASE 626-05 ISSUE K

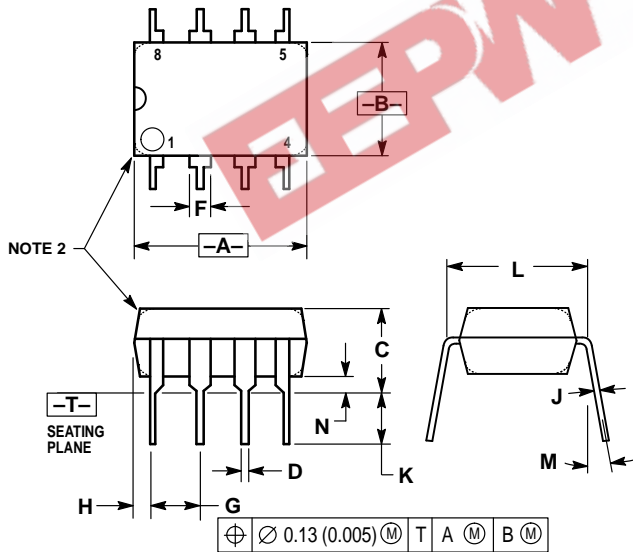

NOTES:

1. DIMENSION L TO CENTER OF LEAD WHEN FORMED PARALLEL.
2. PACKAGE CONTOUR OPTIONAL (ROUND OR SQUARE CORNERS).
3. DIMENSIONING AND TOLERANCING PER ANSI Y14.5M, 1982.

MILLIMETERS		INCHES		
DIM	MIN	MAX	MIN	MAX
A	9.40	10.16	0.370	0.400
B	6.10	6.60	0.240	0.260
C	3.94	4.45	0.155	0.175
D	0.38	0.51	0.015	0.020
F	1.02	1.78	0.040	0.070
G	2.54 BSC		0.100 BSC	
H	0.76	1.27	0.030	0.050
J	0.20	0.30	0.008	0.012
K	2.92	3.43	0.115	0.135
L	7.62 BSC		0.300 BSC	
M		10°		10°
N	0.76	1.01	0.030	0.040

MC33102

EEPW 电子产品世界
.com.cn

Motorola reserves the right to make changes without further notice to any products herein. Motorola makes no warranty, representation or guarantee regarding the suitability of its products for any particular purpose, nor does Motorola assume any liability arising out of the application or use of any product or circuit, and specifically disclaims any and all liability, including without limitation consequential or incidental damages. "Typical" parameters which may be provided in Motorola data sheets and/or specifications can and do vary in different applications and actual performance may vary over time. All operating parameters, including "Typicals" must be validated for each customer application by customer's technical experts. Motorola does not convey any license under its patent rights nor the rights of others. Motorola products are not designed, intended, or authorized for use as components in systems intended for surgical implant into the body, or other applications intended to support or sustain life, or for any other application in which the failure of the Motorola product could create a situation where personal injury or death may occur. Should Buyer purchase or use Motorola products for any such unintended or unauthorized application, Buyer shall indemnify and hold Motorola and its officers, employees, subsidiaries, affiliates, and distributors harmless against all claims, costs, damages, and expenses, and reasonable attorney fees arising out of, directly or indirectly, any claim of personal injury or death associated with such unintended or unauthorized use, even if such claim alleges that Motorola was negligent regarding the design or manufacture of the part. Motorola and  registered trademarks of Motorola, Inc. Motorola, Inc. is an Equal Opportunity/Affirmative Action Employer.

Mfax is a trademark of Motorola, Inc.

How to reach us:

USA/EUROPE/Locations Not Listed: Motorola Literature Distribution;
P.O. Box 5405, Denver, Colorado 80217. 1-303-675-2140 or 1-800-441-2447

JAPAN: Nippon Motorola Ltd.: SPD, Strategic Planning Office, 4-32-1,
Nishi-Gotanda, Shinagawa-ku, Tokyo 141, Japan. 81-3-5487-8488

Customer Focus Center: 1-800-521-6274

Mfax™: RMFAX0@email.sps.mot.com – TOUCHTONE 1-602-244-6609
Motorola Fax Back System – US & Canada ONLY 1-800-774-1848
– http://sps.motorola.com/mfax/

ASIA/PACIFIC: Motorola Semiconductors H.K. Ltd.; 8B Tai Ping Industrial Park,
51 Ting Kok Road, Tai Po, N.T., Hong Kong. 852-26629298

HOME PAGE: <http://motorola.com/sps/>



MOTOROLA



MC33102/D