



# MC33076

## Dual High Output Current, Low Power, Low Noise Bipolar Operational Amplifier

The MC33076 operational amplifier employs bipolar technology with innovative high performance concepts for audio and industrial applications. This device uses high frequency PNP input transistors to improve frequency response. In addition, the amplifier provides high output current drive capability while minimizing the drain current. The all NPN output stage exhibits no deadband crossover distortion, large output voltage swing, excellent phase and gain margins, low open loop high frequency output impedance and symmetrical source and sink AC frequency performance.

The MC33076 is tested over the automotive temperature range and is available in an 8-pin SOIC package (D suffix) and in both the standard 8 pin DIP and 16-pin DIP packages for high power applications.

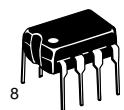
- 100 Ω Output Drive Capability
- Large Output Voltage Swing
- Low Total Harmonic Distortion
- High Gain Bandwidth: 7.4 MHz
- High Slew Rate: 2.6 V/μs
- Dual Supply Operation: ±2.0 V to ±18 V
- High Output Current: ISC = 250 mA typ
- Similar Performance to MC33178

### DUAL HIGH OUTPUT CURRENT OPERATIONAL AMPLIFIER

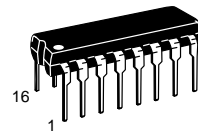
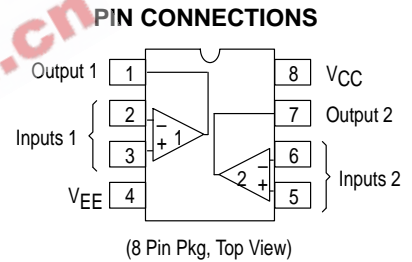
#### SEMICONDUCTOR TECHNICAL DATA



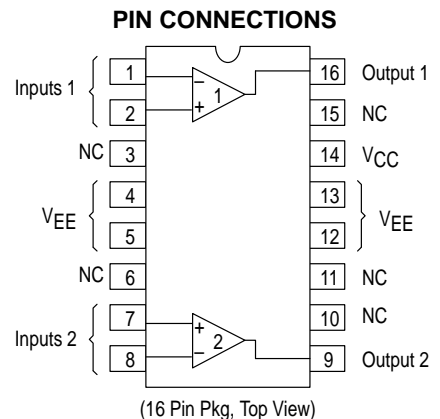
**D SUFFIX**  
PLASTIC PACKAGE  
CASE 751  
(SO-8)



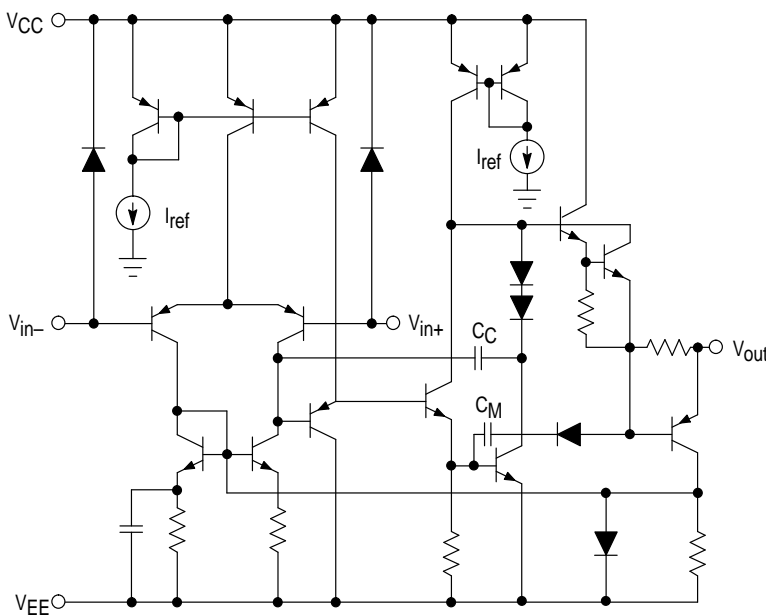
**P1 SUFFIX**  
PLASTIC PACKAGE  
CASE 626



**P2 SUFFIX**  
PLASTIC PACKAGE  
CASE 648C  
DIP (12+2+2)



**Equivalent Circuit Schematic**  
(Each Amplifier)



#### ORDERING INFORMATION

Device	Operating Temperature Range	Package
MC33076D	T <sub>A</sub> = -40° to +85°C	SO-8
MC33076P1		Plastic DIP
MC33076P2		Power Plastic

# MC33076

## MAXIMUM RATINGS

Rating	Symbol	Value	Unit
Power Supply Voltage (Note 2)	$V_{CC}$ to $V_{EE}$	+36	V
Input Differential Voltage Range	$V_{IDR}$	(Note 1)	V
Input Voltage Range	$V_{IR}$	(Note 1)	V
Output Short Circuit Duration (Note 2)	$t_{SC}$	5.0	sec
Maximum Junction Temperature	$T_J$	+150	°C
Storage Temperature	$T_{stg}$	-60 to +150	°C
Maximum Power Dissipation	$P_D$	(Note 2)	mW

NOTES: 1. Either or both input voltages should not exceed  $V_{CC}$  or  $V_{EE}$ .

2. Power dissipation must be considered to ensure maximum junction temperature ( $T_J$ ) is not exceeded (see power dissipation performance characteristic, Figure 1). See applications section for further information.

## DC ELECTRICAL CHARACTERISTICS ( $V_{CC} = +15$ V, $V_{EE} = -15$ V, $T_A = 25^\circ\text{C}$ , unless otherwise noted.)

Characteristics	Figure	Symbol	Min	Typ	Max	Unit
Input Offset Voltage ( $R_S = 50 \Omega$ , $V_{CM} = 0$ V) ( $V_S = \pm 2.5$ V to $\pm 15$ V) $T_A = +25^\circ\text{C}$ $T_A = -40^\circ$ to $+85^\circ\text{C}$	2	$ V_{IO} $	— —	0.5 0.5	4.0 5.0	mV
Input Offset Voltage Temperature Coefficient ( $R_S = 50 \Omega$ , $V_{CM} = 0$ V) $T_A = -40^\circ$ to $+85^\circ\text{C}$		$\Delta V_{IO}/\Delta T$	—	2.0	—	$\mu\text{V}/^\circ\text{C}$
Input Bias Current ( $V_{CM} = 0$ V) $T_A = +25^\circ\text{C}$ $T_A = -40^\circ$ to $+85^\circ\text{C}$	3, 4	$I_{IB}$	— —	100 —	500 600	nA
Input Offset Current ( $V_{CM} = 0$ V) $T_A = +25^\circ\text{C}$ $T_A = -40^\circ$ to $+85^\circ\text{C}$		$ I_{IO} $	— —	5.0 —	70 100	nA
Common Mode Input Voltage Range	5	$V_{ICR}$	-13	-14 +14	13	V
Large Signal Voltage Gain ( $V_O = -10$ V to $+10$ V) ( $T_A = +25^\circ\text{C}$ ) $R_L = 100 \Omega$ $R_L = 600 \Omega$ ( $T_A = -40^\circ$ to $+85^\circ\text{C}$ ) $R_L = 600 \Omega$	6	$A_{VOL}$	25 50 25	— 200 —	— — —	kV/V
Output Voltage Swing ( $V_{ID} = \pm 1.0$ V) ( $V_{CC} = +15$ V, $V_{EE} = -15$ V) $R_L = 100 \Omega$ $R_L = 100 \Omega$ $R_L = 600 \Omega$ $R_L = 600 \Omega$ ( $V_{CC} = +2.5$ V, $V_{EE} = -2.5$ V) $R_L = 100 \Omega$ $R_L = 100 \Omega$	7, 8, 9	$V_{O+}$ $V_{O-}$ $V_{O+}$ $V_{O-}$ $V_{O+}$ $V_{O-}$	10 — 13 — 1.2 —	+11.7 -11.7 +13.8 -13.8 +1.66 -1.74	— -10 — -13 — -1.2	V
Common Mode Rejection ( $V_{in} = \pm 13$ V)	10	CMR	80	116	—	dB
Power Supply Rejection ( $V_{CC}/V_{EE} = +15$ V/-15 V, +5.0 V/-15 V, +15 V/-5.0 V)	11	PSR	80	120	—	dB

## MC33076

### DC ELECTRICAL CHARACTERISTICS ( $V_{CC} = +15\text{ V}$ , $V_{EE} = -15\text{ V}$ , $T_A = 25^\circ\text{C}$ , unless otherwise noted.)

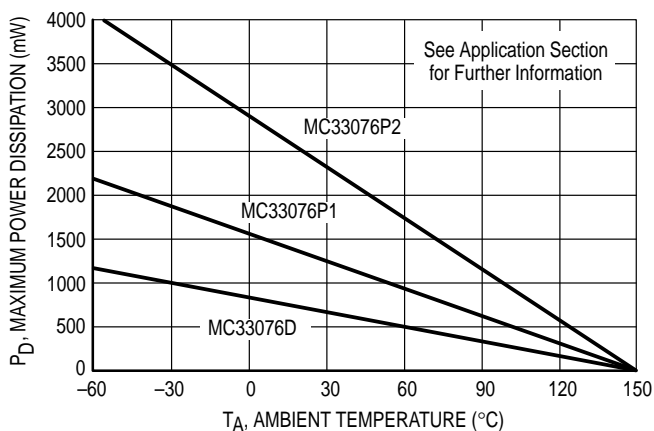
Characteristics	Figure	Symbol	Min	Typ	Max	Unit
Output Short Circuit Current ( $V_{ID} = \pm 1.0\text{ V}$ Output to Gnd) ( $V_{CC} = +15\text{ V}$ , $V_{EE} = -15\text{ V}$ ) Source Sink ( $V_{CC} = +2.5\text{ V}$ , $V_{EE} = -2.5\text{ V}$ ) Source Sink	12, 13	$I_{SC}$	190 —	+250 -280	— -215	mA
Power Supply Current per Amplifier ( $V_O = 0\text{ V}$ ) ( $V_S = \pm 2.5\text{ V}$ to $\pm 15\text{ V}$ ) $T_A = +25^\circ\text{C}$ $T_A = -40^\circ$ to $+85^\circ\text{C}$	14	$I_D$	— —	2.2 —	2.8 3.3	mA

### AC ELECTRICAL CHARACTERISTICS ( $V_{CC} = +15\text{ V}$ , $V_{EE} = -15\text{ V}$ , $T_A = 25^\circ\text{C}$ , unless otherwise noted.)

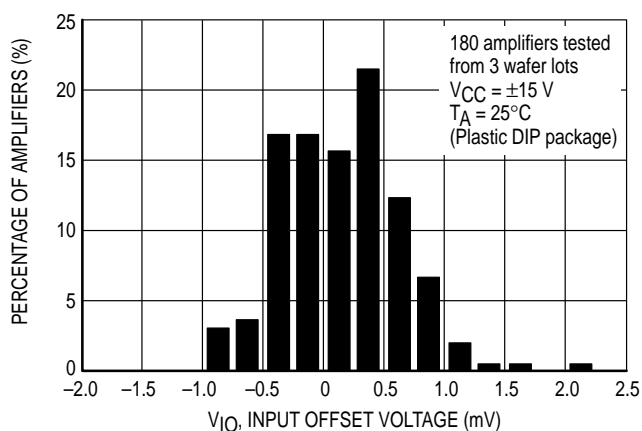
Characteristics	Figure	Symbol	Min	Typ	Max	Unit
Slew Rate ( $V_{in} = -10\text{ V}$ to $+10\text{ V}$ , $R_L = 100\ \Omega$ , $C_L = 100\text{ pF}$ , $A_V = +1$ )	15	SR	1.2	2.6	—	V/ $\mu\text{s}$
Gain Bandwidth Product ( $f = 20\text{ kHz}$ )	16	GBW	4.0	7.4	—	MHz
Unity Gain Frequency (Open Loop) ( $R_L = 600\ \Omega$ , $C_L = 0\text{ pF}$ )	—	$f_U$	—	3.5	—	MHz
Gain Margin ( $R_L = 600\ \Omega$ , $C_L = 0\text{ pF}$ )	19, 20	$A_m$	—	15	—	dB
Phase Margin ( $R_L = 600\ \Omega$ , $C_L = 0\text{ pF}$ )	19, 20	$\phi_m$	—	52	—	Deg
Channel Separation ( $f = 100\text{ Hz}$ to $20\text{ kHz}$ )	21	CS	—	-120	—	dB
Power Bandwidth ( $V_O = 20\text{ V}_{pp}$ , $R_L = 600\ \Omega$ , THD $\leq 1\%$ )	—	$BW_p$	—	32	—	kHz
Total Harmonic Distortion ( $R_L = 600\ \Omega$ , $V_O = 2.0\text{ V}_{pp}$ , $A_V = +1$ ) $f = 1.0\text{ kHz}$ $f = 10\text{ kHz}$ $f = 20\text{ kHz}$	22	THD	— — —	0.0027 0.011 0.022	— — —	%
Open Loop Output Impedance ( $V_O = 0\text{ V}$ , $f = 2.5\text{ MHz}$ , $A_V = 10$ )	23	$ Z_O $	—	75	—	$\Omega$
Differential Input Resistance ( $V_{CM} = 0\text{ V}$ )	—	$R_{in}$	—	200	—	k $\Omega$
Differential Input Capacitance ( $V_{CM} = 0\text{ V}$ )	—	$C_{in}$	—	10	—	pF
Equivalent Input Noise Voltage ( $R_S = 100\ \Omega$ ) $f = 10\text{ Hz}$ $f = 1.0\text{ kHz}$	24	$e_n$	— —	7.5 5.0	—	nV/ $\sqrt{\text{Hz}}$
Equivalent Input Noise Current $f = 10\text{ Hz}$ $f = 1.0\text{ kHz}$	—	$i_n$	— —	0.33 0.15	—	pA/ $\sqrt{\text{Hz}}$

# MC33076

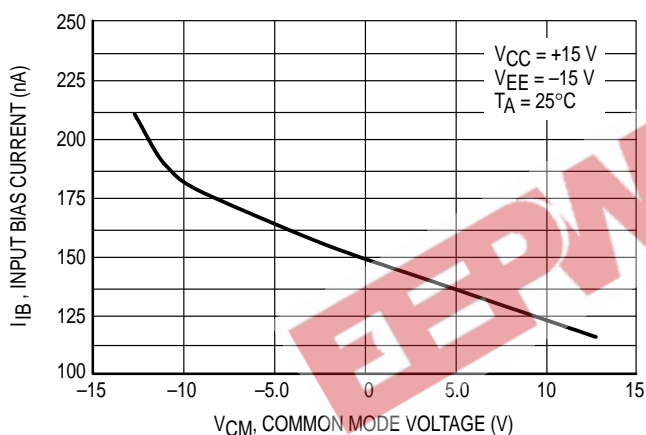
**Figure 1. Maximum Power Dissipation versus Temperature**



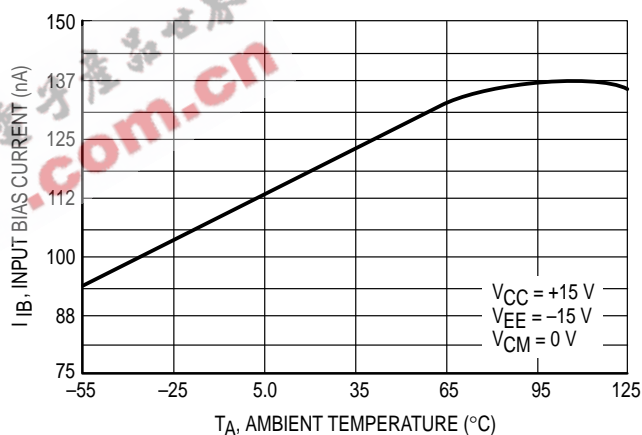
**Figure 2. Distribution of Input Offset Voltage**



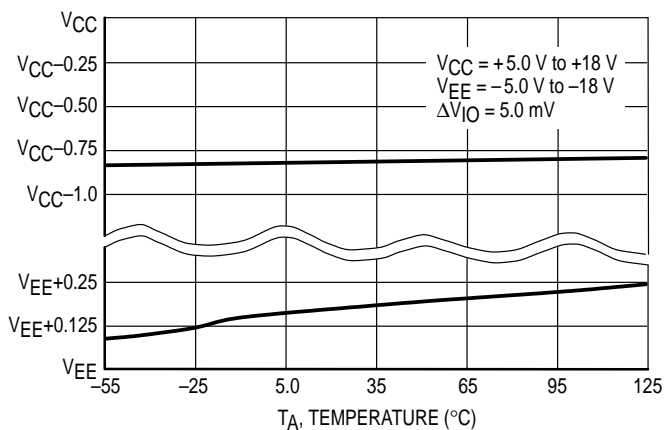
**Figure 3. Input Bias Current versus Common Mode Voltage**



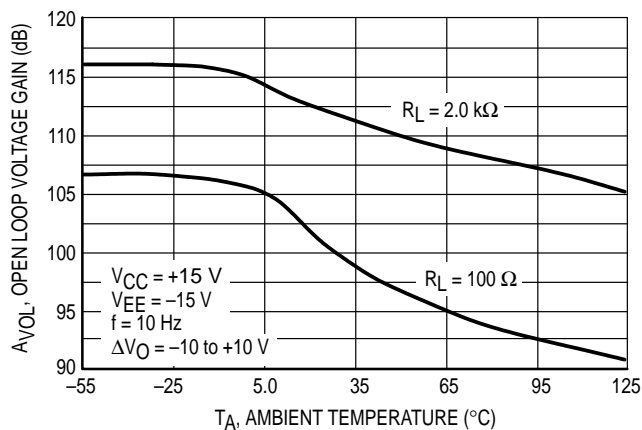
**Figure 4. Input Bias Current versus Temperature**



**Figure 5. Input Common Mode Voltage Range versus Temperature**

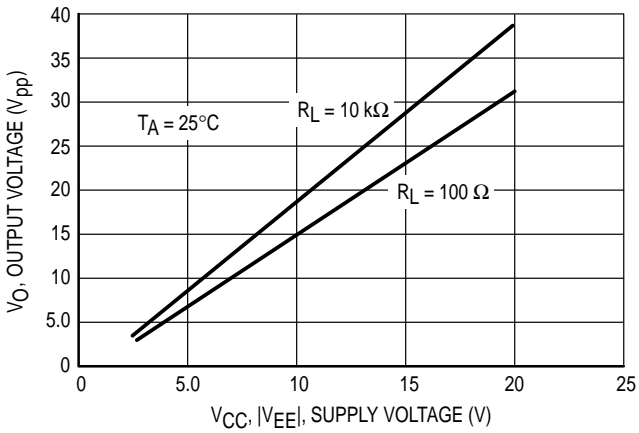


**Figure 6. Open Loop Voltage Gain versus Temperature**

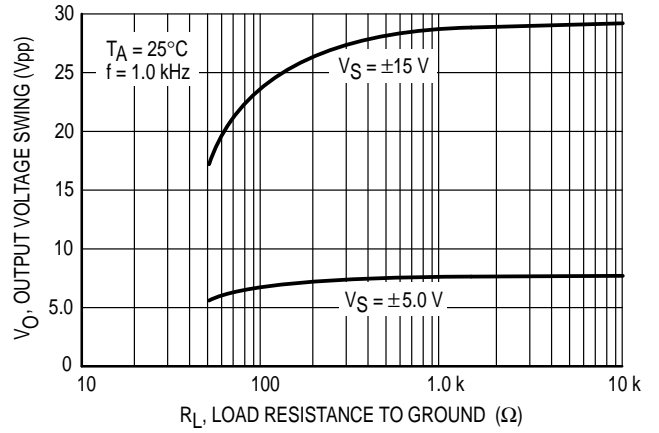


# MC33076

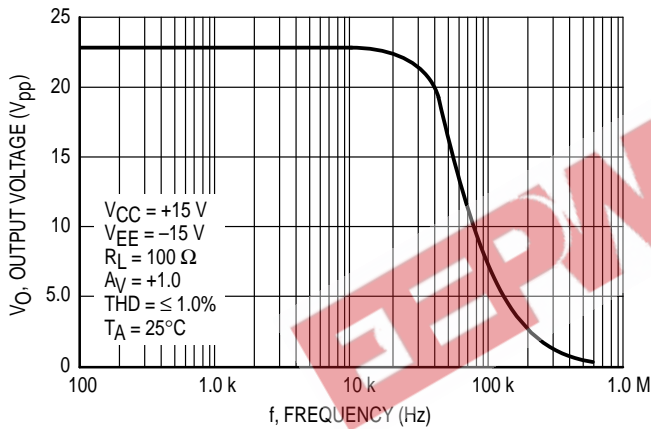
**Figure 7. Output Voltage Swing versus Supply Voltage**



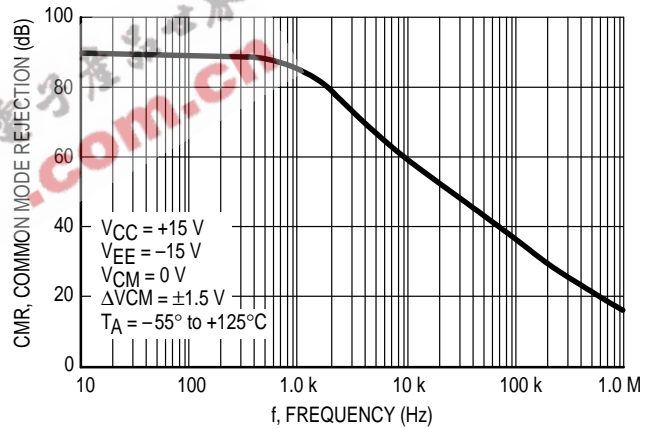
**Figure 8. Maximum Peak-to-Peak Output Voltage Swing versus Load Resistance**



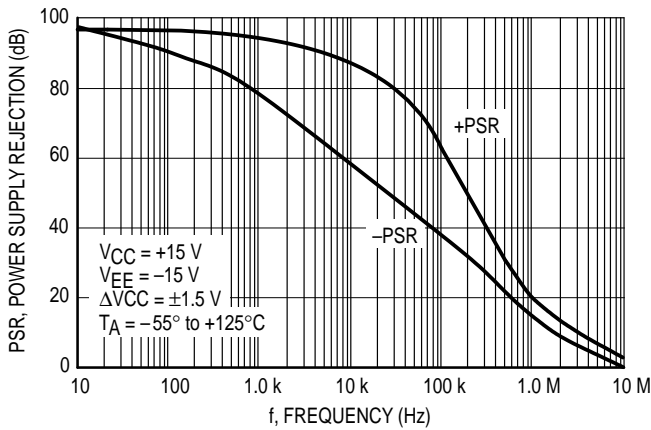
**Figure 9. Output Voltage versus Frequency**



**Figure 10. Common Mode Rejection versus Frequency Over Temperature**



**Figure 11. Power Supply Rejection versus Frequency Over Temperature**



**Figure 12. Output Short Circuit Current versus Output Voltage**

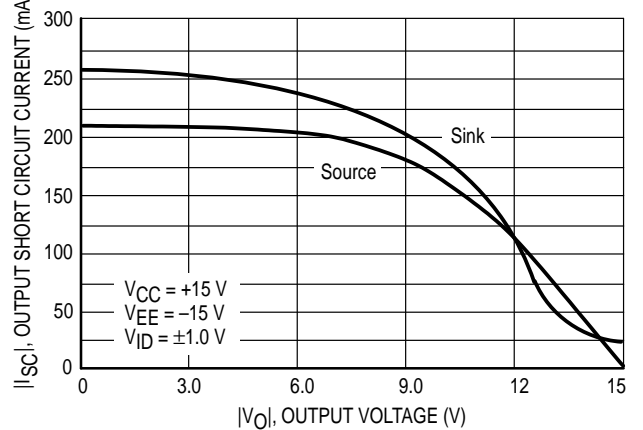


Figure 13. Output Short Circuit Current versus Temperature

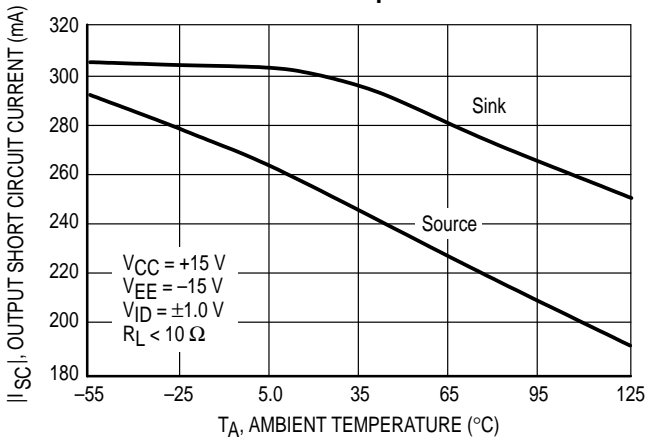


Figure 14. Supply Current versus Supply Voltage with No Load

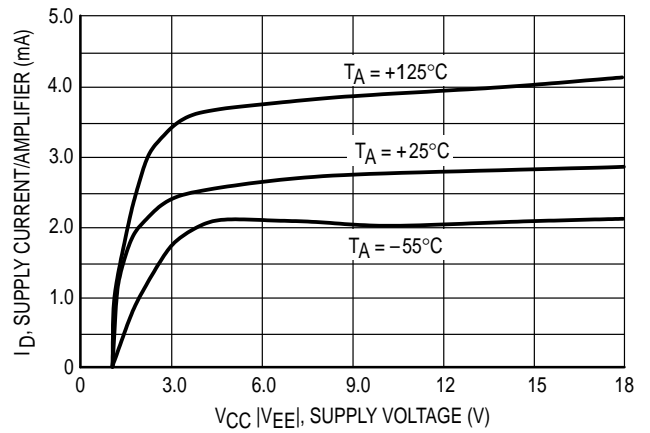


Figure 15. Slew Rate versus Temperature

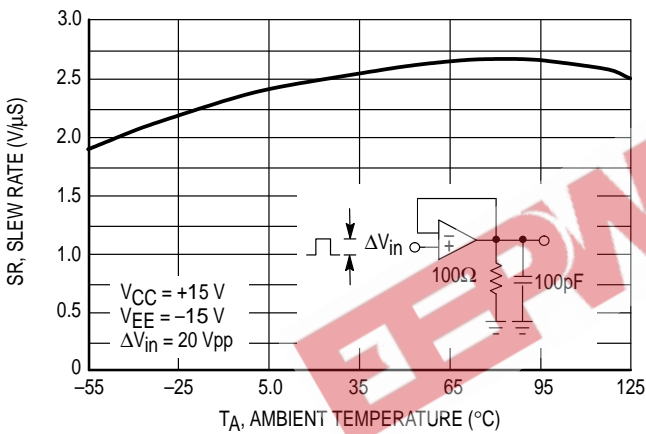


Figure 16. Gain Bandwidth Product versus Temperature

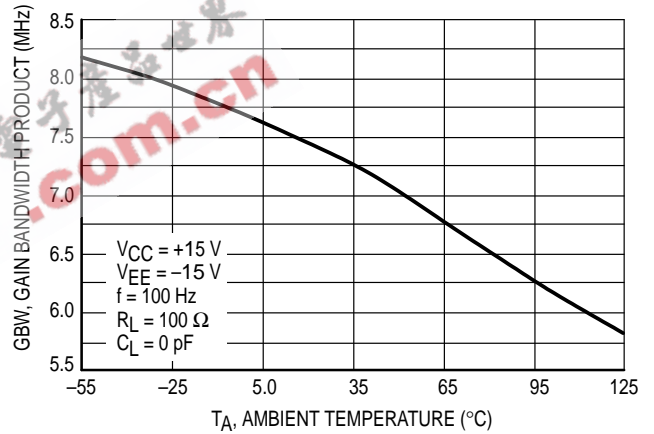


Figure 17. Voltage Gain and Phase versus Frequency

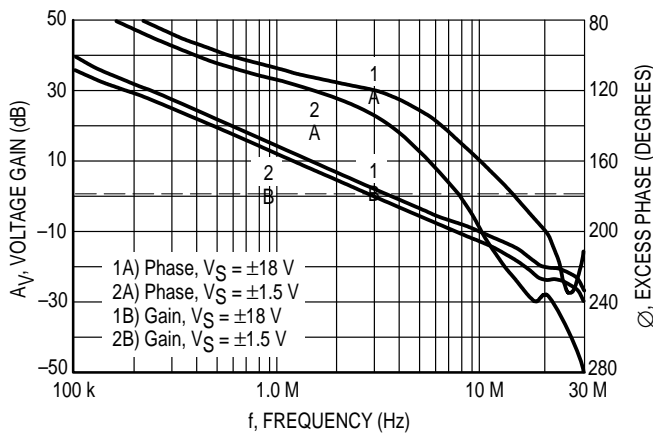
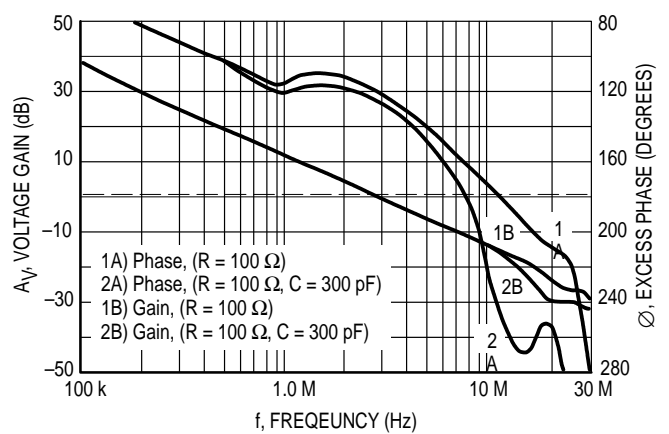
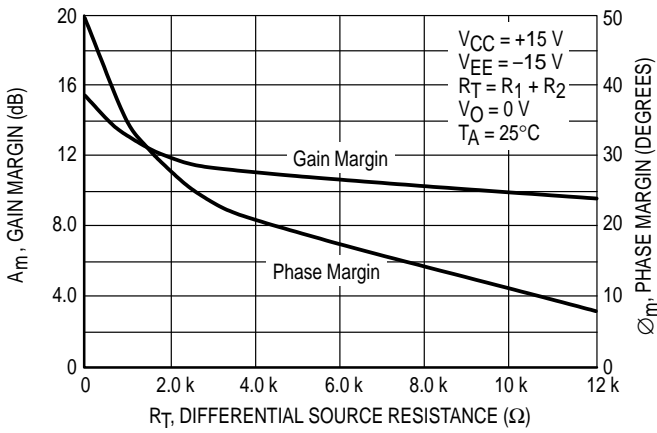


Figure 18. Voltage Gain and Phase versus Frequency

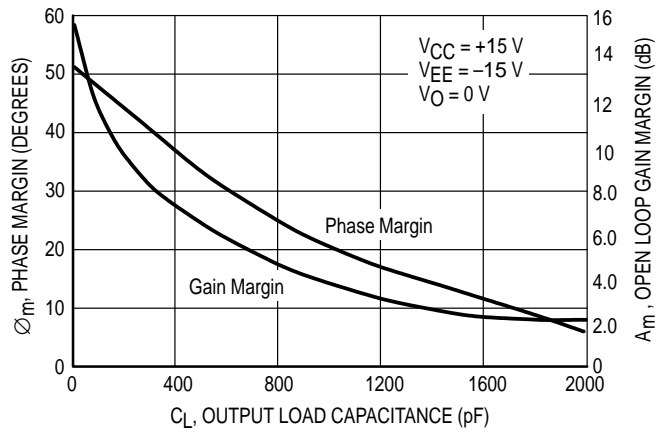


# MC33076

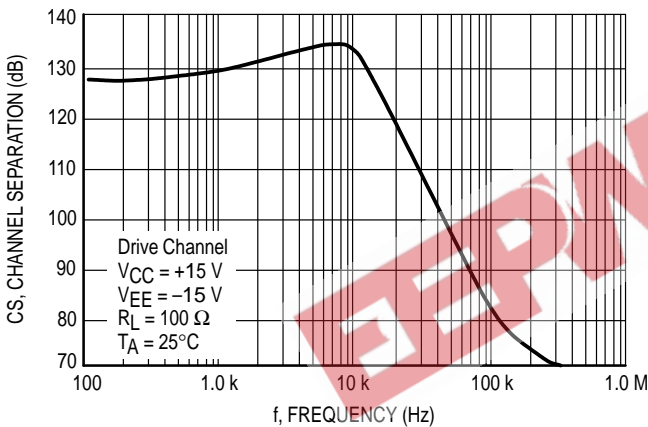
**Figure 19. Phase Margin and Gain Margin versus Differential Source Resistance**



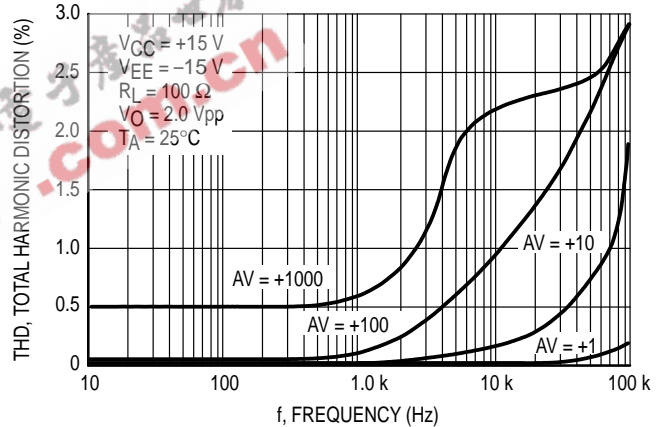
**Figure 20. Open Loop Gain Margin and Phase Margin versus Output Load Capacitance**



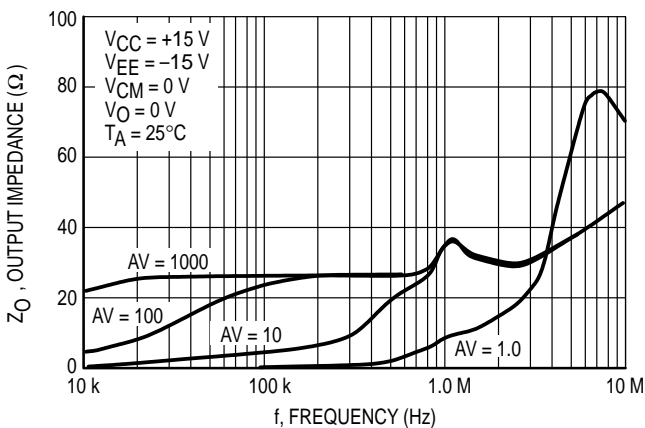
**Figure 21. Channel Separation versus Frequency**



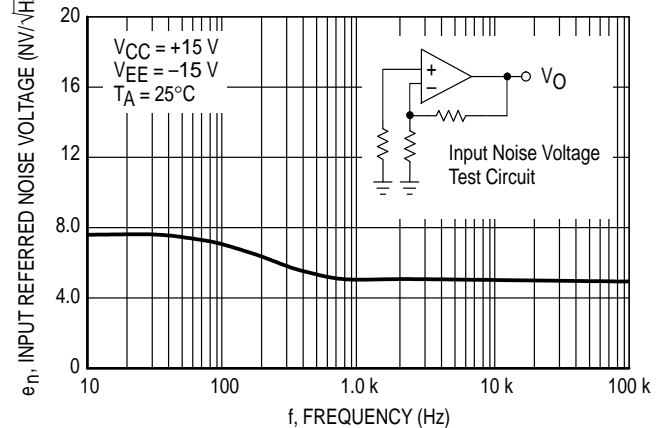
**Figure 22. Total Harmonic Distortion versus Frequency**



**Figure 23. Output Impedance versus Frequency**

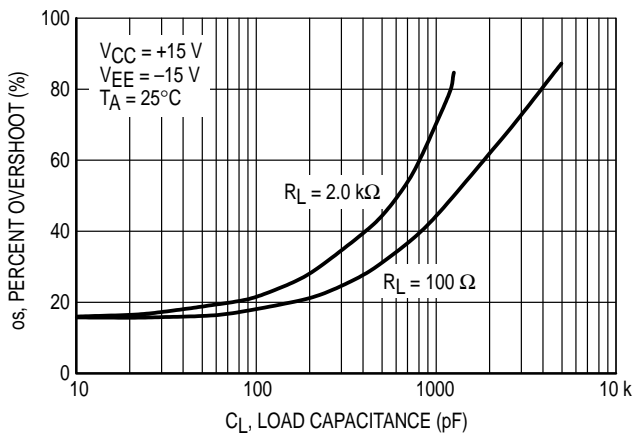


**Figure 24. Input Referred Noise Voltage versus Frequency**

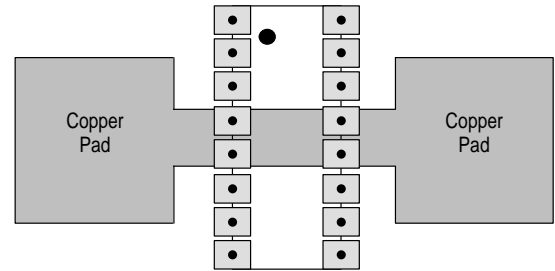


## MC33076

**Figure 25. Percent Overshoot versus Load Capacitance**



**Figure 26. PC Board Heatsink Example**



### APPLICATIONS INFORMATION

The MC33076 dual operational amplifier is available in the standard 8-pin plastic dual-in-line (DIP) and surface mount packages, and also in a 16-pin batwing power package. To enhance the power dissipation capability of the power package, Pins 4, 5, 12, and 13 are tied together on the leadframe, giving it an ambient thermal resistance of  $52^\circ\text{C/W}$

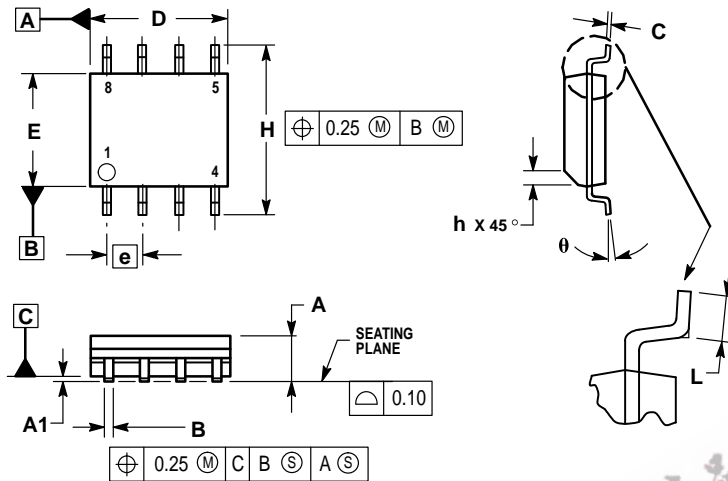
typically, in still air. The junction-to-ambient thermal resistance ( $R_{\theta JA}$ ) can be decreased further by using a copper pad on the printed circuit board (as shown in Figure 26) to draw the heat away from the package. *Care must be taken not to exceed the maximum junction temperature or damage to the device may occur.*



# MC33076

## OUTLINE DIMENSIONS

### D SUFFIX PLASTIC PACKAGE CASE 751-05 (SO-8) ISSUE R

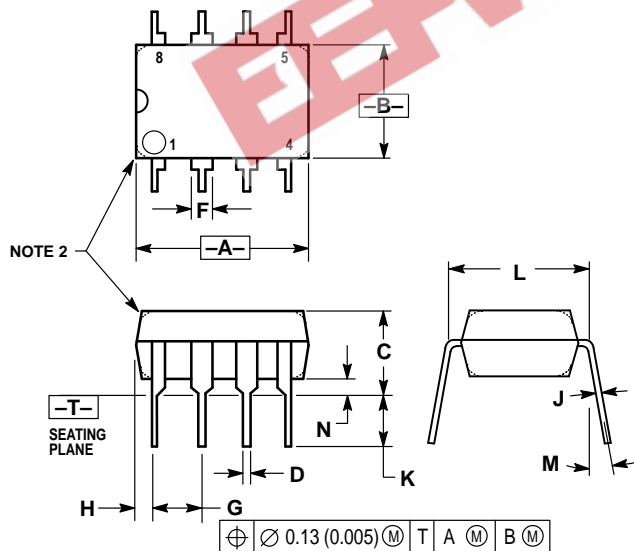


NOTES:

1. DIMENSIONING AND TOLERANCING PER ASME Y14.5M, 1994.
2. DIMENSIONS ARE IN MILLIMETERS.
3. DIMENSION D AND E DO NOT INCLUDE MOLD PROTRUSION.
4. MAXIMUM MOLD PROTRUSION 0.15 PER SIDE.
5. DIMENSION B DOES NOT INCLUDE MOLD PROTRUSION. ALLOWABLE DAMBAR PROTRUSION SHALL BE 0.127 TOTAL IN EXCESS OF THE B DIMENSION AT MAXIMUM MATERIAL CONDITION.

DIM	MILLIMETERS	
	MIN	MAX
A	1.35	1.75
A1	0.10	0.25
B	0.35	0.49
C	0.18	0.25
D	4.80	5.00
E	3.80	4.00
e	1.27 BSC	
H	5.80	6.20
h	0.25	0.50
L	0.40	1.25
$\theta$	0°	7°

### P1 SUFFIX PLASTIC PACKAGE CASE 626-05 ISSUE K



NOTES:

1. DIMENSION L TO CENTER OF LEAD WHEN FORMED PARALLEL.
2. PACKAGE CONTOUR OPTIONAL (ROUND OR SQUARE CORNERS).
3. DIMENSIONING AND TOLERANCING PER ANSI Y14.5M, 1982.

DIM	MILLIMETERS		INCHES	
	MIN	MAX	MIN	MAX
A	9.40	10.16	0.370	0.400
B	6.10	6.60	0.240	0.260
C	3.94	4.45	0.155	0.175
D	0.38	0.51	0.015	0.020
F	1.02	1.78	0.040	0.070
G	2.54 BSC		0.100 BSC	
H	0.76	1.27	0.030	0.050
J	0.20	0.30	0.008	0.012
K	2.92	3.43	0.115	0.135
L	7.62 BSC		0.300 BSC	
M	— 10°		— 10°	
N	0.76	1.01	0.030	0.040

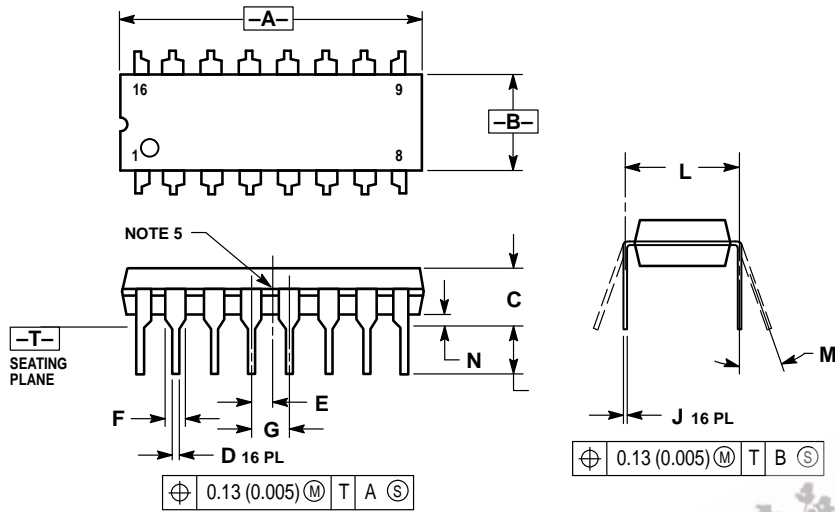
# MC33076

## OUTLINE DIMENSIONS

P2 SUFFIX  
PLASTIC PACKAGE  
CASE 648C-03  
(DIP (12+2+2))  
ISSUE C

NOTES:

1. DIMENSIONING AND TOLERANCING PER ANSI Y14.5M, 1982.
2. CONTROLLING DIMENSION: INCH.
3. DIMENSION L TO CENTER OF LEADS WHEN FORMED PARALLEL.
4. DIMENSION B DOES NOT INCLUDE MOLD FLASH.
5. INTERNAL LEAD CONNECTION BETWEEN 4 AND 5, 12 AND 13.




DIM	INCHES		MILLIMETERS	
	MIN	MAX	MIN	MAX
A	0.740	0.840	18.80	21.34
B	0.240	0.260	6.10	6.60
C	0.145	0.185	3.69	4.69
D	0.015	0.021	0.38	0.53
E	0.050 BSC		1.27 BSC	
F	0.040	0.70	1.02	1.78
G	0.100 BSC		2.54 BSC	
J	0.008	0.015	0.20	0.38
K	0.115	0.135	2.92	3.43
L	0.300 BSC		7.62 BSC	
M	0° 10°		0° 10°	
N	0.015	0.040	0.39	1.01

EEPW.com.cn 电子产品世界

MC33076

EEPW 电子產品世界  
.com.cn

Motorola reserves the right to make changes without further notice to any products herein. Motorola makes no warranty, representation or guarantee regarding the suitability of its products for any particular purpose, nor does Motorola assume any liability arising out of the application or use of any product or circuit, and specifically disclaims any and all liability, including without limitation consequential or incidental damages. "Typical" parameters which may be provided in Motorola data sheets and/or specifications can and do vary in different applications and actual performance may vary over time. All operating parameters, including "Typicals" must be validated for each customer application by customer's technical experts. Motorola does not convey any license under its patent rights nor the rights of others. Motorola products are not designed, intended, or authorized for use as components in systems intended for surgical implant into the body, or other applications intended to support or sustain life, or for any other application in which the failure of the Motorola product could create a situation where personal injury or death may occur. Should Buyer purchase or use Motorola products for any such unintended or unauthorized application, Buyer shall indemnify and hold Motorola and its officers, employees, subsidiaries, affiliates, and distributors harmless against all claims, costs, damages, and expenses, and reasonable attorney fees arising out of, directly or indirectly, any claim of personal injury or death associated with such unintended or unauthorized use, even if such claim alleges that Motorola was negligent regarding the design or manufacture of the part. Motorola and  are registered trademarks of Motorola, Inc. Motorola, Inc. is an Equal Opportunity/Affirmative Action Employer.

MC33076

EEPW 电子产品世界  
.com.cn

**How to reach us:**

**USA/EUROPE/Locations Not Listed:** Motorola Literature Distribution;  
P.O. Box 20912; Phoenix, Arizona 85036. 1-800-441-2447 or 602-303-5454

**MFAX:** RMFAX0@email.sps.mot.com – TOUCHTONE 602-244-6609  
**INTERNET:** <http://Design-NET.com>

**JAPAN:** Nippon Motorola Ltd.; Tatsumi-SPD-JLDC, 6F Seibu-Butsuryu-Center,  
3-14-2 Tatsumi Koto-Ku, Tokyo 135, Japan. 03-81-3521-8315

**ASIA/PACIFIC:** Motorola Semiconductors H.K. Ltd.; 8B Tai Ping Industrial Park,  
51 Ting Kok Road, Tai Po, N.T., Hong Kong. 852-26629298



**MOTOROLA**



MC33076/D

