

Advance Information

MC44BS374T1/374T1A
Rev. 1.2 11/2003

PLL Tuned UHF and
VHF Audio/Video High
Integration Modulator

MC44BS374T1
MC44BS374T1A



SO16NB Package

Ordering Information

Device	Temp Range	Package
MC44BS374T1D,R2	0°C to +70°C	SO16NB
MC44BS374T1AD,R2	0°C to +70°C	SO16NB

NOTE: For tape and reel, add R2 suffix.

Contents

1Features 2

Comparing the
MC44BS374T1/374T1A to
the MC44BC374T1 2

Pin Descriptions 3

Functional Overview 4

Maximum Ratings 5

Thermal Ratings 5

Electrostatic Discharge ... 5

Electrical Characteristics . 6

I2C Bit Mapping 7

I2C Programming 8

Modulator High Frequency
Characteristics 10

Video Characteristics ... 11

Audio Characteristics ... 13

Characterization
Measurement Conditions
14

Modes of Operation 20

High Speed I2C Compatible
Bus 24

Pin Circuit Schematics .. 27

Application Diagrams ... 28

Evaluation Board Schematic
and Layout 29

Packaging Instructions .. 31

Marking Instructions31

The MC44BS374T1 and MC44BS374T1A audio and video modulator are for use in VCRs, set-top boxes, and similar devices. These products are the next generation of the MC44BC374T1 with the following new features:

- TV output level 82dBuV typical for the MC44BS374T1A, 75 dBuV for the MC44BS374T1
- 5V and 3.3V compatible I²C bus
- Logic Output Port pin (pin 3) available

Figure 1 shows the pin connections.

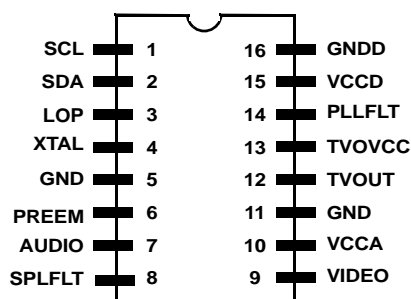

SO16 pin package

Figure 1. MC44BS374T1 and MC44BS374T1A Pin Connections

1 Features

The MC44BS374T1/374T1A is a PAL/NTSC Modulator with integrated VCO.

The channel is set by an on-chip high-speed I²C compatible bus receiver. A Phase-Locked Loop (PLL) tunes the modulator over the full UHF range.

The modulator incorporates a sound subcarrier oscillator and uses a second PLL to derive 4.5, 5.5, 6.0, and 6.5 MHz subcarrier frequencies. These frequencies are selectable by bus.

The picture-to-sound ratio may be adjusted using the bus. In addition, an on-chip video test pattern generator can be switched ON with a 1 KHz audio test signal.

The MC44BS374T1/374T1A have the following features:

- Integrated on-chip programmable UHF oscillator
- No external varicaps diodes/inductor or tuned components
- Extremely low external components count
- Channel 21-69 UHF operation
- VHF range possible by internal dividers (30MHz-450MHz)
- Boosted TV output level (82 dBuV typical) for the MC44BS374T1A
- TV output level of 75 dBuV typical for the MC44BS374T1
- High speed read and write I²C-bus compatible (800kHz)
- I²C-bus 5V and 3.3V compatible
- Fixed video modulation depth (82% typical)
- Peak White Clip disabled by bus
- Programmable picture/sound carrier ratio (12 dB and 16 dB)
- Integrated on-chip programmable sound subcarrier oscillator (4.5, 5.5, 6.0 and 6.5 MHz) - No external varicaps
- On-chip video test pattern generator with sound test signal (1kHz)
- Low-power programmable modulator standby mode
- Transient output inhibit during PLL Lock-up at power-ON
- Logical Output Port controlled by bus
- Start-up on channel '71' (871.25 MHz)
- ESD protection, minimum 4 kV

2 Comparing the MC44BS374T1 and MC44BS374T1A to the MC44BC374T1

Compared to the MC44BC374T1 devices, the MC44BS374T1/374T1A has the following improvements:

- Higher output level for the MC44BS374T1A (82 dBuV versus 74.5 dBuV)
- Higher Video signal to noise (+ 3 dB) for the MC44BS374T1A
- I²C-bus 3.3V compatible
- Lower power consumption in normal and standby modes (-2 mA)

- The device can be powered down without holding the I²C lines down
- Switch between the two integrated VCO's controlled directly by the frequency divider (@ 700 MHz)
- The external standby pin is no more required as the I²C lines are not hold down when the device is not powered up.
- The standby pin is replaced by the LOP Logic Output Port pin (pin 3)
- Lower RF second harmonic spurious but higher third harmonic spurious. In the application it is easier to filter UHF third harmonics spurious than second harmonics as these frequencies are always out of the UHF band. Unfortunately the second harmonic can fall back into the same UHF band (for instance channel 21 second harmonic). For this reason it is almost impossible to have a good rejection of low UHF second harmonic with an external low pass filter. This is the reason why the design has been optimized for a maximum second harmonic rejection in spite of an increase of the third harmonic.

3 Pin Descriptions

Table 1. SO16 Package Pin Descriptions

Pin number	Pin Name	Description
1	SCL	I2C clock
2	SDA	I2C data
3	LOP	Logical output port controlled by I2C bus
4	XTAL	Crystal
5	GND	Ground
6	PREEMP	Pre-emphasis capacitor
7	AUDIO	Audio input
8	SPLFLT	Sound PLL loop filter
9	VIDEO	Video input
10	VCCA	Main analog supply voltage
11	GND	Analog ground
12	TVOUT	TV output signal
13	TVOVCC	TV output stage supply voltage
14	PLLFLT	RF PLL loop filter
15	VCCD	Digital supply voltage
16	GNDD	Digital ground

4 Functional Overview

Figure 2 shows a simplified block diagram of the MC44BS374T1/374T1A device.

The MC44BS374T1/374T1A device has three main sections:

1. A high speed I²C-compatible bus section
2. A PLL section to synthesize the UHF/VHF output channel frequency (from an integrated UHF oscillator, divided for VHF output)
3. A modulator section, which accepts audio and video inputs, then uses them to modulate the UHF/VHF carrier

An on-chip video test pattern generator with an audio test signal is included.

The MC44BS374T1/374T1A operates as a multi-standard modulator and can handle the following systems using the same external circuit components: B/G, I, D/K, M/N.

High frequency BiCMOS technology allows integration of the UHF tank circuit and certain filtering functions.

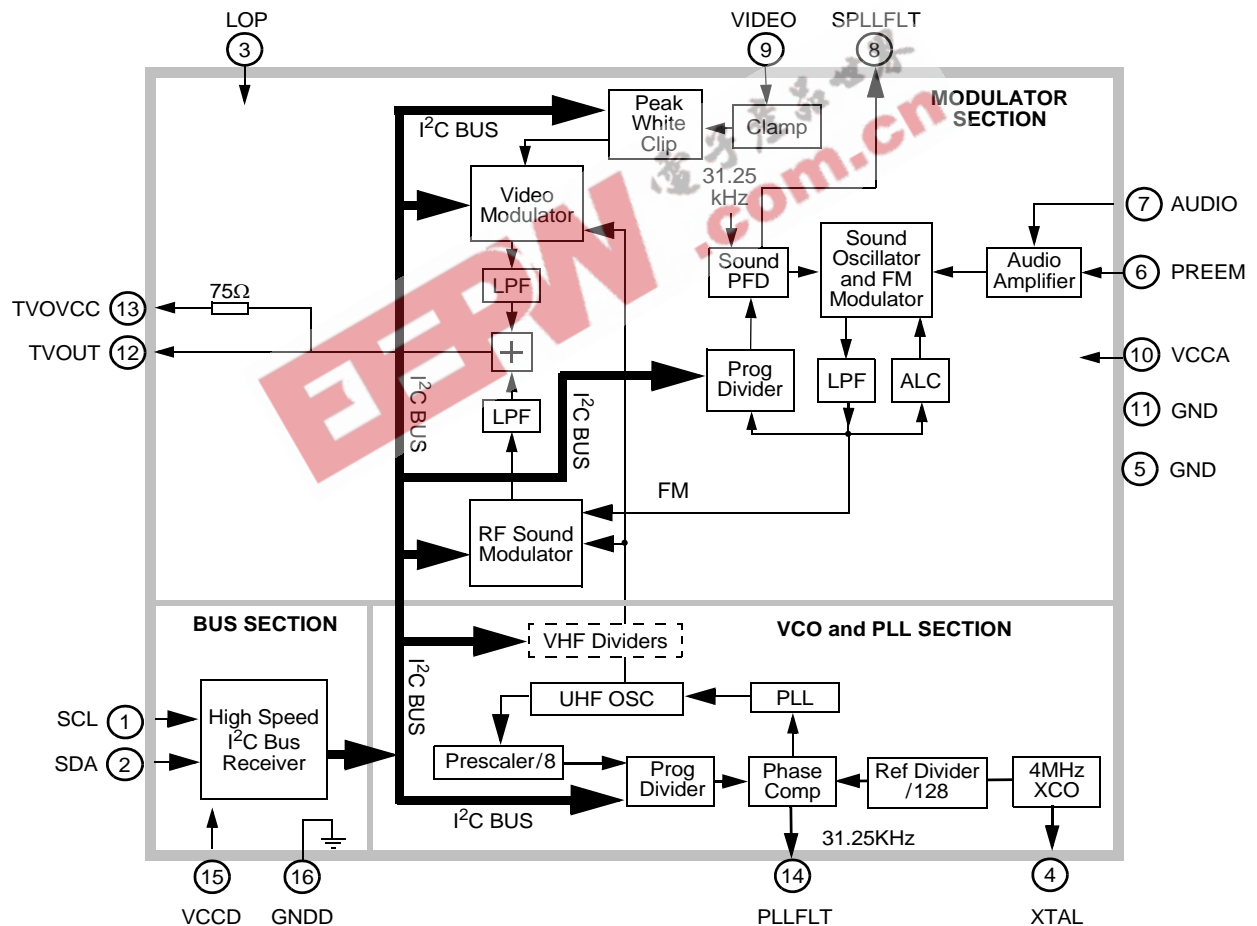

Figure 2. MC44BS374T1/374T1A Simplified Block Diagram

5 Maximum Ratings

Sym	Parameter	Value	Unit
Vcc	Supply voltage	6	V
Tamin	Minimum operating ambient temperature	0	°C
Tamax	Maximum operating ambient temperature	+70	°C
Tstgmin	Minimum storage temperature	-65	°C
Tstgmax	Maximum storage temperature	150	°C
Tj	Junction Temperature	150	°C

This device contains protection circuitry to guard against damage due to high static voltage or electric fields. However, precautions must be taken to avoid applications of any voltage higher than maximum rated voltages to this high impedance circuit. For proper operation, input and output voltages should be constrained to the ranges indicated in the Recommended Operating Conditions.

Note: Maximum ratings are those values beyond which damage to the device may occur. For functional operation, values should be restricted to the Recommended Operating Condition.

Note: Meets Moisture Sensitivity Level 1, no dry pack required.

6 Thermal Ratings

Sym	Parameter	Value	Unit
R _{thja}	Thermal resistance from Junction to Ambient	102	°C/W

7 Electrostatic Discharge

Electrostatic Discharge (ESD) tests are done on all pin

Sym	Parameter	Min	Unit
ESD	MM (Machine Model) - MIL STD 883C method 3015-7	400	V
ESD	HBM (Human Body Model) - MIL STD 883C method 3015-7	4000	V

8 Electrical Characteristics

- A = 100% tested
- B = 100% Correlation tested
- C = Characterized on samples
- D = Design parameter

See Characterization conditions section for each C type parameter.

8.1 Operating Conditions

Unless otherwise stated: $V_{CC}=5.0V$, Ambient Temperature= $25^{\circ}C$, Video Input $1V_{p-p}$, 10-step grayscale. RF output into 75Ohm load.

NOTE:

Specifications only valid for envelope demodulation.

Table 2. Operating Conditions

Parameter	Min	Typ	Max	Unit	Notes	Type
Operating supply voltage range	4.5	5.0	5.5	V		B
Total supply current	42	50	58	mA	All sections active	A
Total standby mode supply current	3	5	7	mA	OSC=0, SO=1, ATT=1 Bus Section active	A
Test pattern sync pulse width	3	4.7	6.5	μS		B
Sound comparator charge pump current						
During locking	7	10	12	μA		A
When locked	0.7	1	1.5	μA		A
RF comparator charge pump current	60	100	150	μA		A
Crystal oscillator stability-negative resistance	1	-	-	K Ω		D
Logic Output Port						
Saturation voltage at I=2mA	-	160	300	mV		A
Leakage current	-	-	1	μA		A

Freescale Semiconductor, Inc.

9 I²C Bit Mapping

WRITE MODE	Bit 7	Bit 6	Bit 5	Bit 4	Bit 3	Bit 2	Bit 1	Bit 0	ACK
CA-CHIP ADDRESS	1	1	0	0	1	0	1	0	ACK
C1-High Order Bits	1	0	SO	LOP	PS	X3	X2	0	ACK
C0-Low Order Bits	PWC	OSC	ATT	SFD1	SFD0	0	X5	X4	ACK
FM-High Order Bits	0	TPEN	N11	N10	N9	N8	N7	N6	ACK
FL-Low Order Bits	N5	N4	N3	N2	N1	N0	X1	X0	ACK
READ MODE	Bit 7	Bit 6	Bit 5	Bit 4	Bit 3	Bit 2	Bit 1	Bit 0	ACK
CHIP ADDRESS	1	1	0	0	1	0	1	1	ACK
R-Status Byte	-	-	-	-	-	Y2	Y1	OOR	-
Bit Name	Description								
PWC	Peak White Clip enable/disable								
OSC	UHF oscillator ON/OFF								
ATT	Modulator output attenuated-sound and video modulators ON/OFF								
SFD0, 1	Sound subcarrier frequency control bits								
SO	Sound Oscillator ON/OFF								
LOP	Logic Output Port								
PS	Picture-to-sound carrier ratio								
TPEN	Test pattern enable-picture and sound								
X5...X0	Test mode bits-All bits are 0 for normal operation (see Test Mode tables, page 6 & page 7) except "OSC" bit (normal mode is "1")								
N0...N11	UHF frequency programming bits, in steps of 250kHz								
OOR	RF oscillator out-of-frequency range information								
Y1, Y2	RF oscillator operating range information								

10 I²C Programming

Sound

SFD1	SFD0	Sound Subcarrier Freq (MHz)
0	0	4.5
0	1	5.5
1	0	6.0
1	1	6.5

PS	Picture-to-Sound Ratio (dB)
0	12
1	16

SO	Sound Oscillator
0	Sound oscillator ON (Normal mode)
1	Sound oscillation disabled (oscillator and PLL section bias turned OFF)

Video

PWC	Peak White Clip
0	Peak White Clip ON (System B/G)
1	Peak White Clip OFF (System L)

TPEN	Test Pattern Signal
0	Test pattern signal OFF (normal operation)
1	Test pattern signal ON (picture and sound)

UHF

OSC	UHF Oscillator
1	Normal operation
0	UHF oscillator disabled (oscillator and PLL sections bias turned OFF)

ATT	Modulator Output Attenuation
0	Normal operation
1	Modulator output attenuation (sound and video modulators sections bias turned OFF).

Standby Mode

OSC	SO	ATT	Combination of 3-bits
0	1	1	Modulator standby mode

Logic Output Port

LOP	Description
0	Pin 3 is low voltage
1	Pin 3 is high impedance

WRITE MODE: Test Mode 1 and VHF Range

X2	X1	X0	State	Description
0	0	0	1.a	Normal operation
0	0	1	1.b	RF frequency divided for low frequency testing or VHF range: RF/2
0	1	0	1.c	RF/4
0	1	1	1.d	RF/8
1	0	0	1.e	RF/16
1	0	1	1.f	DC drive applied to modulators: Non-inverted video at TVOUT
1	1	0	1.g	DC drive applied to modulators: Inverted video at TVOUT
1	1	1	1.h	Transient output inhibit disabled (ie speed up mode) During this speed-up test mode, ATT=0 forces sound current source to 1μA, and ATT=1 forces it to 10μA.

WRITE MODE: Test Mode 2

X5	X4	X3	State	Description
0	0	0	2.a	Normal operation
0	0	1	2.b	Test pattern generator DC verification (Test pattern DC test mode available)
0	1	0	2.c	Program divider test (UHF program divider on PLLFILT pin and sound program divider on SPLLFIL pin)
0	1	1	2.d	Reference divider test (UHF reference divider on PLLFILT pin)
1	0	0	2.e	UHF phase comparison, upper source on PLLFILT pin Sound phase comparison 10 μ A upper source on SPLLFIL (Only valid during transient output inhibit.)
1	0	1	2.f	UHF phase comparison, lower source on PLLFILT pin Sound phase comparison 10 μ A lower source on SPLLFIL (Only valid during transient output inhibit.)
1	1	0	2.g	Sound phase comparison 1 μ A upper source on SPLLFIL (Not valid during transient output inhibit.)
1	1	1	2.h	Sound phase comparison 1 μ A lower source on SPLLFIL (Not valid during transient output inhibit.)

NOTE:

Test modes 1 and 2 are intended for manufacturing test purposes only and cannot be used for normal applications, except for VHF range (states 1.b to 1.e).

READ MODE

OOR	Description
0	Normal operation, VCO in range
1	VCO out of range

Y1	Description
0	VCO out of range, frequency too low, only valid if OOR=1
1	VCO out of range, frequency too high, only valid if OOR=1

Y2	Description
0	High VCO is active
1	Low VCO is active

11 MC44BS374T1A High Frequency Characteristics

Unless otherwise stated: $V_{cc}=5.0V$, Ambient Temperature= $25^{\circ}C$, Video Input $1V_{p-p}$, 10-step grayscale. RF inputs/outputs into 75 Ohm load.

NOTE:

Specifications only valid for envelope demodulation.

Table 3. High Frequency Characteristics

Parameter	Test Conditions	Min	Typ	Max	Unit	Type
TVOUT output level	Output signal from modulator section See Figure 3. See Note 2	79	82	85	$dB_{\mu}V$	B
UHF oscillator frequency		460	-	880	MHz	A
VHF range	From UHF oscillator internally divided	45	-	460	MHz	B
TVOUT output attenuation	During transient output inhibit, or when ATT bit is set to 1. See Figure 3. See Note 2	65	75	-	dBc	B
Sound subcarrier harmonics (F_{p+n*Fs})	Reference picture carrier. See Note 2	50	63	-	dBc	C
Second harmonic of chroma subcarrier	Using red EBU bar. See Note 2	45	70	-	dBc	C
Chroma/Sound intermodulation: $F_{p+}(F_{snd}-F_{chr})$	Using red EBU bar. See Note 2	65	82	-	dBc	C
F_o (picture carrier) harmonics	2nd harmonic: CH21 3rd harmonic: CH21 Other channels: See Figure 3. See NOTE 1. See Note 2	-	38 58	50 70	$dB_{\mu}V$	C
Out band (picture carrier) spurious	$1/2*F_o - 1/4*F_o - 3/2*F_o - 3/4*F_o$ From 40MHz to 1GHz. See Note 2	-	-	10	$dB_{\mu}V$	C
In band spurious ($F_o @ 5MHz$)	No video sound modulation. See Note 2	65	75	-	dBc	C
<p>Note: 1: Picture carrier harmonics are highly dependant on PCB layout and decoupling capacitors. Note: 2: See "Characterization Measurement Conditions" on page 15.</p>						

Freescale Semiconductor, Inc.

Freescale Semiconductor, Inc.

MC44BS374T1 High Frequency Characteristics

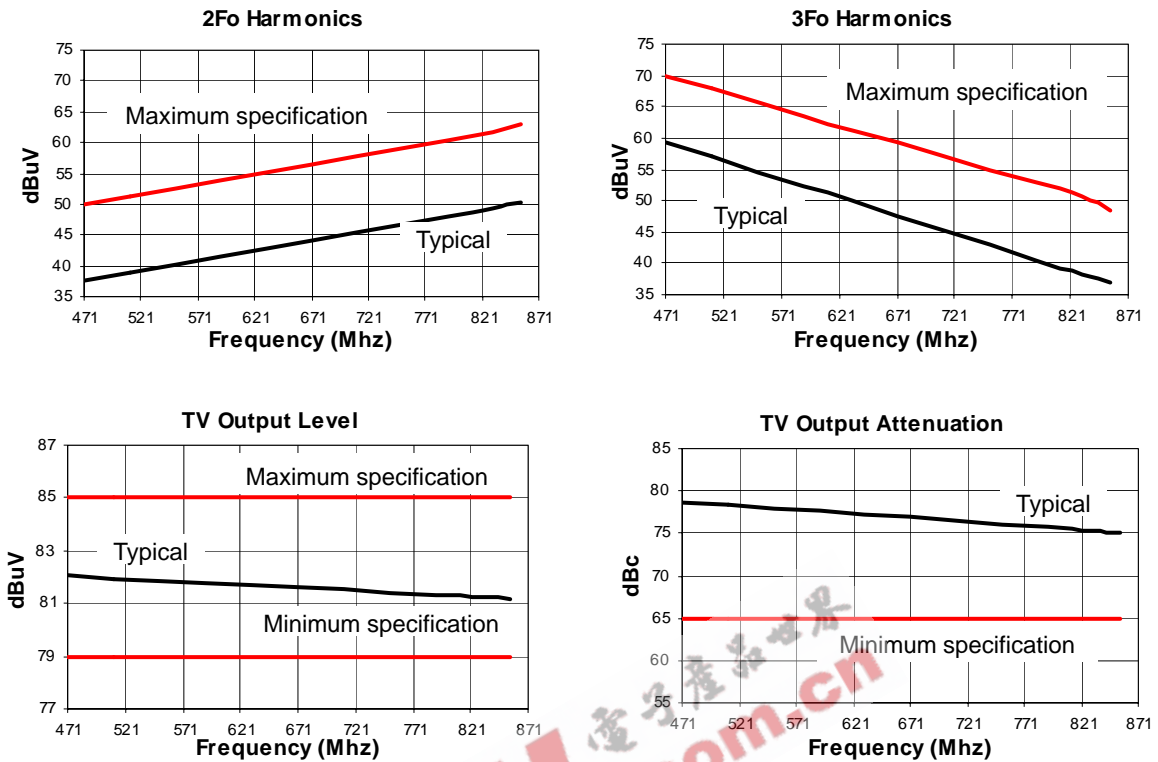

Figure 3. Typical High Frequency Performance

12 MC44BS374T1 High Frequency Characteristics

Unless otherwise stated: $V_{cc}=5.0V$, Ambient Temperature= $25^{\circ}C$, Video Input $1V_{p-p}$, 10-step grayscale. RF inputs/outputs into 75 Ohm load.

NOTE:

Specifications only valid for envelope demodulation.

Table 4. High Frequency Characteristics

Parameter	Test Conditions	Min	Typ	Max	Unit	Type
TVOUT output level for MC44BS374T1A	Output signal from modulator section See Figure 3. See Note 2		75		dB μ V	B
UHF oscillator frequency		460	-	880	MHz	A
VHF range	From UHF oscillator internally divided	45	-	460	MHz	B
TVOUT output attenuation	During transient output inhibit, or when ATT bit is set to 1. See Figure 3. See Note 2		65	-	dBc	B

Table 4. High Frequency Characteristics

Parameter	Test Conditions	Min	Typ	Max	Unit	Type
Sound subcarrier harmonics (Fp+n*Fs)	Reference picture carrier. See Note 2	50	63	-	dBc	C
Second harmonic of chroma subcarrier	Using red EBU bar. See Note 2	45	70	-	dBc	C
Chroma/Sound intermodulation: Fp+ (Fsnd - Fchr)	Using red EBU bar. See Note 2	65	82	-	dBc	C
Fo (picture carrier) harmonics	2nd harmonic: CH21 3rd harmonic: CH21 Other channels: See Figure 3. See NOTE 1. See Note 2	-	32 52	46 64	dB μ V	C
Out band (picture carrier) spurious	1/2*Fo - 1/4*Fo - 3/2*Fo - 3/4*Fo From 40MHz to 1GHz. See Note 2	-	-	4	dB μ V	C
In band spurious (Fo @5MHz)	No video sound modulation. See Note 2	65	75	-	dBc	C

Note: 1: Picture carrier harmonics are highly dependant on PCB layout and decoupling capacitors.
Note: 2: See "Characterization Measurement Conditions" on page 15.

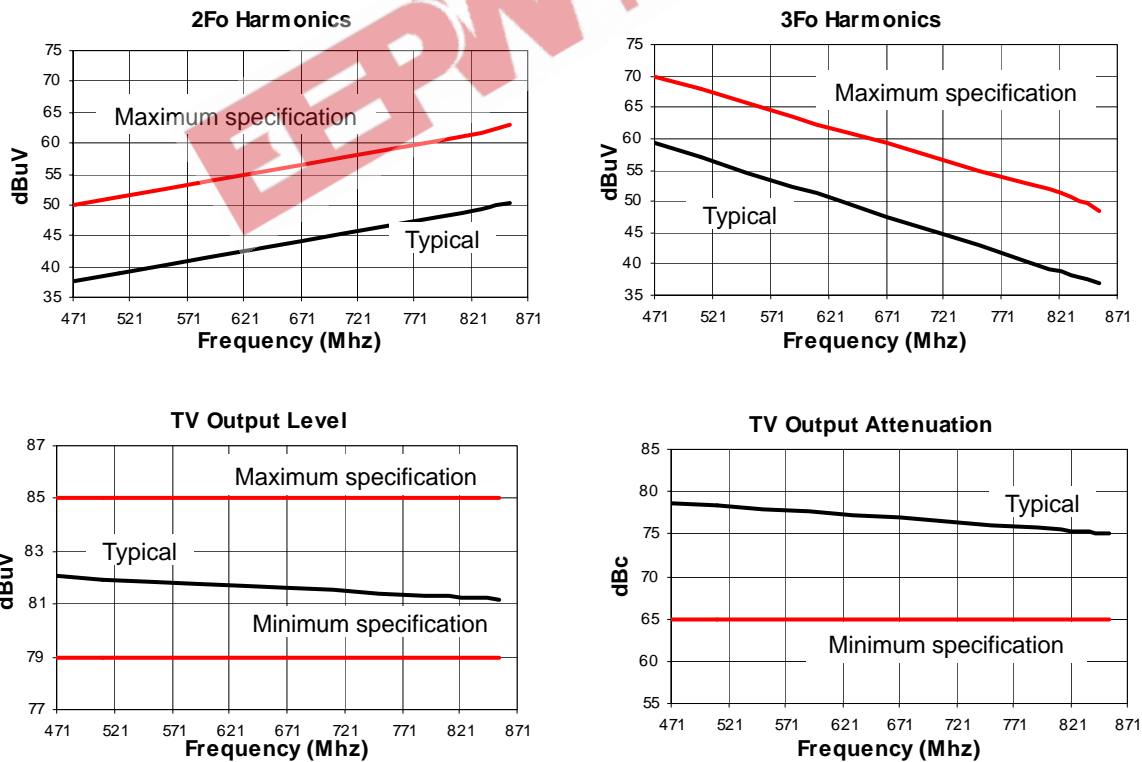

Figure 4. Typical High Frequency Performance

Freescale Semiconductor, Inc.

13 Video Characteristics

Unless otherwise stated: $V_{cc}=5.0V$, Ambient Temperature= $25^{\circ}C$, Video Input $1V_{p-p}$, 10-step grayscale. RF output into 75 Ohm load.

Note: Specifications only valid for envelope demodulation.

Table 5. Video Performance Characteristics

Parameter	Test Conditions	Min	Typ	Max	Unit	Type
Video bandwidth	Reference 0dB at 100kHz, measured at 5MHz. See Note 2	-1.5	-0.8	-	dB	C
Video input level	75Ohm load	-	-	1.5	Vcvbs	D
Video input current		-	0.2	1	μA	A
Video input impedance		500	-	-	K Ω	A
Peak White Clip	Video Modulation depth for video= $1.4V_{CVBS}$	90.5	94	97.5	%	B
Video S/N for the MC44BS374T1A	No sound modulation, 100% white video					
	Using CCIR Rec.567 weighting filter See Figure 5. See Note 2	53	56	-	dB	C
	Unweighted. See Note 2	48	53	-		C
Video S/N for the MC44BS374T1	No sound modulation, 100% white video					
	Using CCIR Rec.567 weighting filter See Figure 5. See Note 2	53	56	-	dB	C
	Unweighted. See Note 2	48	53	-		C
Differential Phase	CCIR Test Line 330, See Note 2	-5	-	5	deg	C
Differential Gain	CCIR Test Line 330, See Note 2	-5	-	5	%	C
Luma/Sync ratio	Input ratio 7.0:3.0	6.8/ 3.2	7.0/ 3.0	7.2/ 2.8	-	B
Video modulation depth	See Figure 5. See Note 2	76	82	88	%	B
Note: 2: See "Characterization Measurement Conditions" on page 15.						

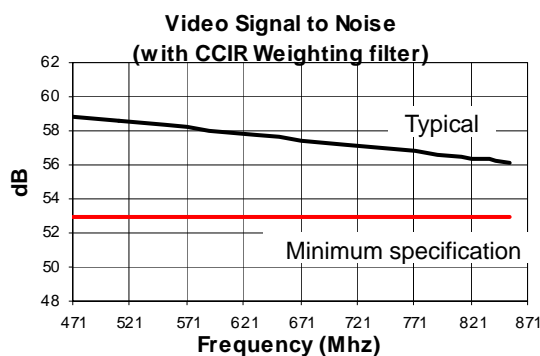

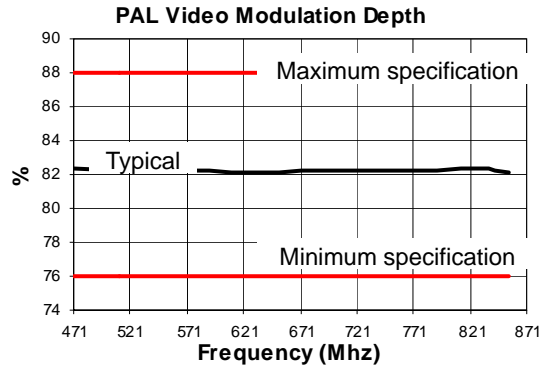

Figure 5. Typical Video Performance

14 Audio Characteristics

Unless otherwise stated: $V_{cc}=5.0V$, Ambient Temperature= $25^{\circ}C$, Video Input $1V_{p-p}$, 10-step grayscale. RF inputs/outputs into 75 Ohm load.

Note: Specifications only valid for envelope demodulation.

Table 6. Audio Performance Characteristics

Parameter	Test Conditions	Min	Typ	Max	Unit	Type
Picture-to-Sound ratio	PS bit set to 0 PS bit set to 1	9 13	12 16	15 19	dB	B
Audio modulation depth	Using specific pre-emphasis circuit, audio input level= $205mV_{rms}$ -audio frequency= $1kHz$					
	FM modulation: $F_s=5.5, 6$ or $6.5MHz$ 100% modulation= $\pm 50kHz$ FM deviation	76	80	84	%	B
	FM modulation: NTSC $F_s=4.5MHz$ 100% modulation= $\pm 25kHz$ FM deviation	76	80	84	%	B
Audio input resistance		45	53	61	$K\Omega$	A
Audio Frequency response	Reference 0dB at 1kHz, using specified pre-emphasis circuit, measure from 50Hz to 15kHz <i>Depends on loop filter components</i>	-2.0	-	+2.0	dB	C
Audio Distortion FM (THD only)	at 1kHz, 100% modulation ($\pm 50kHz$) No video	-	0.2	0.8	%	C
Audio S/N with Sync Buzz FM	Ref 1Khz, 50% modulation ($\pm 25Khz$) EBU color bars Video signal, using CCIR 468.2 weighting filter	50	54	-	dB	C
Note: 2: See "Characterization Measurement Conditions" on page 15.						

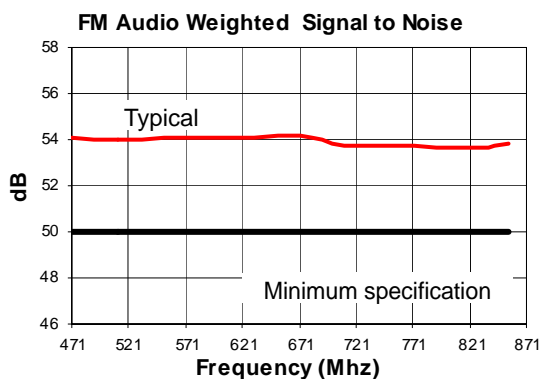

Figure 6. Typical Audio Performance

15 Characterization Measurement Conditions

The following list shows the MC44BS374T1/374T1A default configuration unless otherwise specified.

- Peak White Clip enabled
- UHF oscillator ON
- Sound and video modulators ON
- Sound subcarrier frequency = 5.5 MHz
- Sound Oscillator ON
- Logic Output Port LOW
- Picture-to-sound carrier ratio = 12 dB
- Test pattern disabled
- All test mode bits are '0'
- Frequency from channel 21 to 69

RF Inputs / Output into 75ohm Load using a 75 to 50 ohm transformation. Video Input 1Vpp.
Audio pre-emphasis circuit enabled.

Table 7. Measurement Conditions

Device and Signals Set-up	Measurement Set-up
TVOUT output level	
Video: 10 steps grey scale No audio	Measured picture carrier in dBuV with the HP8596E Spectrum Analyzer using a 75 to 50 ohm transformation, all cables losses and transformation pads having been calibrated. Measurement used as a reference for other tests: TVout_Ref
TVOUT output attenuation	
ATT ⁿ bit = 1 No Video signal No Audio signal	Measure in dBc picture carrier at ATT=1 with reference to picture carrier at ATT=0
Sound Subcarrier Harmonics	
Video: 10 steps grey scale No Audio signal	Measure in dBc second and third sound harmonics levels in reference to picture carrier (TVout_Ref).
Second Harmonics of Chroma subcarrier	
No audio Video: a 700m Vpp 100 kHz sinusoidal signal is inserted on the black level of active video area. 	Measure in dBc, in reference to picture carrier (TVout_Ref), second harmonic of chroma at channel frequency plus 2 times chroma frequency, resulting in the following spectrum.

Table 7. Measurement Conditions

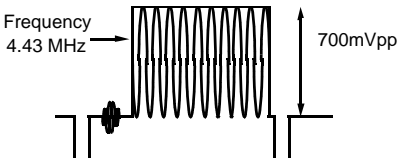
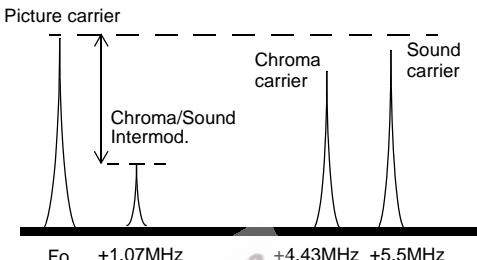
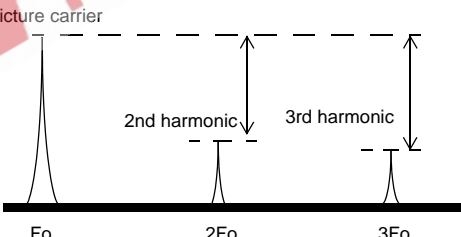
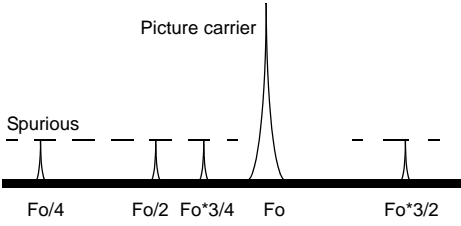
Device and Signals Set-up	Measurement Set-up
Chroma/Sound Intermodulation	
<p>No audio signal Video: 700m Vpp 100 kHz sinusoidal signal inserted on the black level of active video area. This is generated using a Rohde & Schwarz Video Generator SAF and inserting the required frequency from a RF Signal generator.</p> 	<p>Measure in dBc, in reference to picture carrier (TVout_Ref), intermodulation product at channel frequency plus the sound carrier frequency (+5,5 MHz) minus the chroma frequency (-4,43 MHz), resulting in the following spectrum. Intermodulation product is at the channel frequency +1,07 MHz.</p> 
Picture Carrier Harmonics	
<p>No Video signal No Audio signal</p>	<p>Measure in dBc, in reference to picture carrier (TVout_Ref), second and third harmonic of channel frequency, resulting in the following spectrum.</p> 
Out of Band Spurious	
<p>No Video signal No Audio signal</p>	<p>Measure in dBuV spurious levels at 0.25, 0.5, 0.75 and 1.5 times channel frequency, resulting in the following spectrum Measure from 40MHz to 1GHz.</p> 
In Band Spurious	
<p>No Video signal No Audio signal</p>	<p>Measure in dBc, in reference to picture carrier (TVout_Ref), spurious levels falling into video bandwidth starting from +/-100 KHz from the picture carrier up to +/-5MHz.</p>

Freescale Semiconductor, Inc.

Table 7. Measurement Conditions

Device and Signals Set-up	Measurement Set-up
Video Bandwidth	
No audio Video: 600mVpp sinusoidal signal inserted on the black level of active video area.	The Video signal is demodulated on the spectrum analyzer, and the peak level of the 100KHz signal is measured as a reference. The frequency is then swept from 100KHz to 5MHz, and then the difference in dB from the 100KHz reference level is measured.
Weighted Video Signal to Noise	
Video: 100% White video signal - 1Vpk-pk. No Audio signal This is measured using a Rohde & Schwarz AMFS UHF Demodulator in B/G (using a CCIR Rec. 567 weighting network, 100kHz to 5MHz band with sound trap and envelope detection, and a Rohde & Schwarz UAF Video Analyzer.	The Video Analyzer measures the ratio between the amplitude of the active area of the video signal (700mV) and the noise level in Vrms on a video black level which is show below. VideoS/N is calculated as $20 \times \log(700 / N)$ in dB. 
Unweighted Video Signal to Noise	
Same as above with CCIR filter disabled.	Same as above.
Video Differential Phase	
Video: 5 step Grey Scale- 1Vpk-pk. No Audio signal This is measured using a Rohde & Schwarz AMFS UHF Demodulator in B/G (using a CCIR Rec. 567 weighting network, 100kHz to 5MHz band with sound trap, and envelope detection, and a Rohde & Schwarz UAF Video Analyzer.	On line CCIR 330, the video analyzer DP measure consists of calculating the difference of the Chroma phase at the black level and the different chroma subcarrier phase angles at each step of the greyscale. The largest positive or negative difference indicates the distortion. $\text{DIFF PHASE} = \frac{\text{the largest positive or negative difference}}{\text{the phase at position 0}} * 100\%$ The video analyzer method takes the worst step from the first 4 steps.

Table 7. Measurement Conditions

Device and Signals Set-up	Measurement Set-up
Video Differential Gain	
<p>Video: 5 step Grey Scale- 1Vpk-pk. No Audio signal This is measured using a Rohde & Schwarz AMFS UHF Demodulator in B/G (using a CCIR Rec. 567 weighting network, 100kHz to 5MHz band with sound trap and envelope detection, and a Rohde & Schwarz UAF Video Analyzer.</p>	<p>On line CCIR 330 shown below, the video analyzer DG measure consists of calculating the difference of the Chroma amplitude at the black level and the different amplitudes at each step of the greyscale. The largest positive or negative difference indicates the distortion.</p>  <p align="center">5-step Greyscale with Chroma subcarrier superimposed (not to scale), line CCIR 330.</p> $\text{DIFF GAIN} = \frac{\text{the largest positive or negative difference}}{\text{the amplitude at position 0}} * 100\%$ <p>The video analyzer method takes the worst step from the first 4 steps.</p>
Video Modulation Depth	
<p>No Audio signal Video: 10 step grey scale</p>	<p>This is measured using a HP8596E Spectrum Analyzer with a TV Trigger option, allowing demodulation and triggering on any specified TV Line. The analyzer is centred on the maximum peak of the Video signal and reduced to zero Hertz span in Linear mode to demodulate the Video carrier.</p>  <p align="center">TV Line Demodulated by Spectrum Analyzer-BG standard The Modulation Depth is calculated as (A-B)/A x 100 in%</p>
Picture to Sound ratio	
<p>No Video signal No Audio Signal PS" bit set to 0 and 1</p>	<p>Measure in dBc sound carrier in reference to picture carrier (TVout_Ref) for PS" bit=0 (PS=12dB typical) and for PS" bit=1 (PS=16dB),</p> 

Table 7. Measurement Conditions

Device and Signals Set-up	Measurement Set-up
Audio Modulation Depth	
Video Black Level Audio signal: 1Khz, 205mVrms. This is measured using a Rohde & Schwarz AMFS Demodulator in B/G and a HP8903A Audio Analyzer at 1kHz	The audio signal 205mV at 1kHz is supplied by the Audio Analyzer, and the FM demodulated signal deviation is indicated on the Demodulator in Khz peak. This value is then converted in% of FM deviation, based on specified standards.
Audio Frequency response	
Video Black Level Audio signal: 50Hz to 15KHz, 100mV _{rms} This is measured using a Rohde & Schwarz AMFS Demodulator in B/G and a HP8903A.	The audio signal 1KHz 100mV _{rms} is supplied by the Audio Analyzer, demodulated by the Demodulator and the audio analyzer measures the AC amplitude of this demodulated audio signal: this value is taken as a reference (0dB). The audio signal is then swept from 50Hz to 15KHz, and demodulated AC amplitude is measured in dB relative to the 1KHz reference. Audio pre-emphasis and de-emphasis circuits are engaged, all audio analyzer filters are switched OFF.
Audio Distortion FM	
Audio: 1Khz, adjustable level Video Black Level This is measured using a Rohde & Schwarz AMFS UHF Demodulator in B/G and a HP8903A Audio Analyzer at 1kHz. The output level of the Audio analyzer is varied to obtain a deviation of 50kHz indicated on the Demodulator.	The input arms detector of the Audio Analyzer converts the ac level of the combined signal + noise + distortion to dc. It then removes the fundamental signal (1kHz) after having measured the frequency. The output rms detector converts the residual noise + distortion to dc. The dc voltmeter measures both dc signals and calculates the ratio in% of the two signals. $ADist = (Distorsion + Noise)/(Distorsion + Noise + Signal)$
Audio Signal to Noise	
Audio: 1Khz, adjustable level Video: EBU Color Bars This is measured using a Rohde & Schwarz AMFS Demodulator in B/G and a HP8903A Audio Analyzer at 1kHz. The output level of the Audio analyzer is varied to obtain a Modulation Deviation of 25kHz indicated on the AMFS Demodulator.	The Audio Analyzer alternately turns ON and OFF it's internal audio source to make a measure of the Audio signal plus noise and then another measure of only the noise. The measurement is made using the internal CCIR468-2 Filter of the Audio Analyzer together with the internal 30+/-2kHz (60dB/decade) Lowpass filters. The AMFS demodulator uses a quasi-parallel demodulation as is the case in a normal TV set. In this mode the Nyquist filter is bypassed and the video carrier is used without added delay to effectuate intercarrier conversion. In this mode the phase noise information fully cancels out and the true S/N can be measured. $ASN(dB) = 20 \times \log(Signal + Noise)/(Noise)$

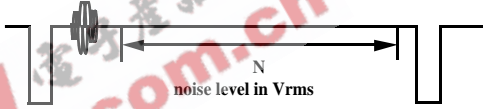
16 Modes of Operation

16.1 Power ON Settings

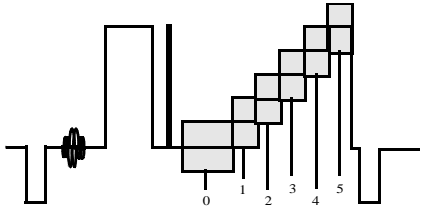
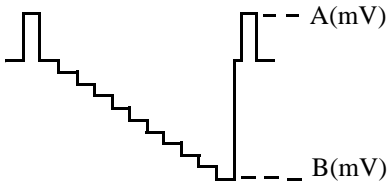
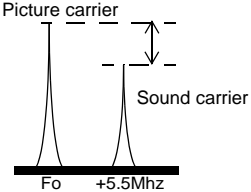
At power-ON, the MC44BS374T1/374T1A is configured as follows:

Table 8. Power ON Settings

WRITE MODE	Bit 7	Bit 6	Bit 5	Bit 4	Bit 3	Bit 2	Bit 1	Bit 0	ACK
C1-High Order Bits	1	0	0	0	0	0	0	0	ACK
C0-Low Order Bits	0	1	0	0	1	0	0	0	ACK
FM-High Order Bits	0	0	N11	N10	N9	N8	N7	N6	ACK
FL-Low Order Bits	N5	N4	N3	N2	N1	N0	0	0	ACK
<p>Note: N0 to N11 are set to have UHF oscillator on channel 71 (871.25MHz).</p> <p>Note: Peak White Clip is ON.</p> <p>Note: Sound frequency is 5.5MHz.</p> <p>Note: Logic Output Port is low voltage</p> <p>Note: Picture to sound ratio is 12dB.</p>									

16.2 Power Supply

The three device Vccs (pins 10, 13 and 15) must be applied at the same time to ensure all internal blocks are correctly biased. Do not bias any other pin before Vcc is applied to the MC44BS374T1/374T1A.

When all Vccs are switched to 0V, SDA and SCL pins are high impedance.

16.3 Standby modes

During standby mode, the modulator is switched to low power consumption. That is, the sound oscillator, UHF oscillator, and the video and sound modulator section's bias are internally turned OFF.

The I²C bus section remains active.

The MC44BS374T1/374T1A can be set to standby mode with a combination of 3 bits: OSC=0, SO=1 and ATT=1

16.4 Transient Output Inhibit

To minimize the risk of interference to other channels while the UHF PLL is acquiring a lock on the desired frequency, the Sound and Video modulators are turned OFF during a time out period for each of the following two cases:

- Power-ON from zero (i.e., all Vcc is switched from 0V to 5V).
- UHF oscillator power-ON from OFF state (i.e., OSC bit is switched from 1 to 0)

There is a time-out of 263ms until the output is enabled. This lets the UHF PLL settle to its programmed frequency. During the 263ms time-out, the sound PLL current source is set to 10μA typical to speed up the locking time. After the 263ms time-out, the current source is switched to 1μA. Use care when selecting loop filter components, to ensure the loop transient does not exceed this delay.

For test purposes, it is possible to disable the 263ms delay using Test Mode 1-State 1.h (this is called speed up mode).

16.5 UHF Oscillator-VHF range

The UHF oscillator is fully integrated and does not require any external components.

For low frequency testing or VHF range operation (test mode 1, states 1.b to 1.e), the UHF oscillator can be internally divided by: 2, 4, 8, or 16.

16.6 UHF PLL Section

The reference divider is a fixed divide-by-128, resulting in a reference frequency of 31.25 KHz with a 4.0MHz crystal.

The prescaler is a fixed divide-by-8 and is permanently engaged.

The programmable divider division-ratio is controlled by the state of control bits N0 to N11. The divider-ratio N for a desired frequency F (in MHz) is given by:

$$N = \frac{F}{8} \times \frac{128}{4}$$

with:

$$N = 2048 \times N11 + 1024 \times N10 + \dots + 4 \times N2 + 2 \times N1 + N0$$

NOTE:

Programming a division-ratio N=0 is not allowed.

16.7 Logic Output Port (LOP)

The LOP pin controls any logic function. The primary applications for the LOP are to control an external attenuator or an external switch, between the antenna input and TV output. A typical attenuator application with PIN diode is shown in Figure 7. The LOP pin switches the PIN attenuator depending on the signal strength of the Antenna Input. This reduces the risks of intermodulation in certain areas. The LOP can also be used as an OFF position bypass switch or for other logic functions in the application.

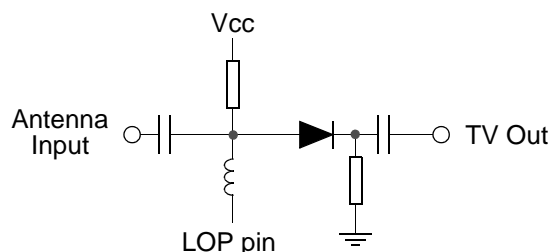

Figure 7. Typical Attenuator Application with Pin Diode

16.8 Video Section - Peak White Clip

The MC44BS374T1/374T1A requires the following for proper video functionality:

- A composite video input with negative going sync pulses
- A nominal level of 1 Vpp

This signal is AC-coupled to the video input where the sync tip level is clamped.

The video signal is then passed to a Peak White Clip (PWC) circuit. The PWC circuit function soft-clips the top of the video waveform, if the sync tip amplitude to peak white clip goes too high. This avoids carrier over-modulation by the video. Clipping can be disabled by software.

16.9 Test Pattern Generator

The I²C generates a simple test pattern, which can be switched under bus control to permit a TV receiver to easily tune to the modulator output. The pattern consists of two white vertical bars on a black background and a 976 Hz audio test signal.

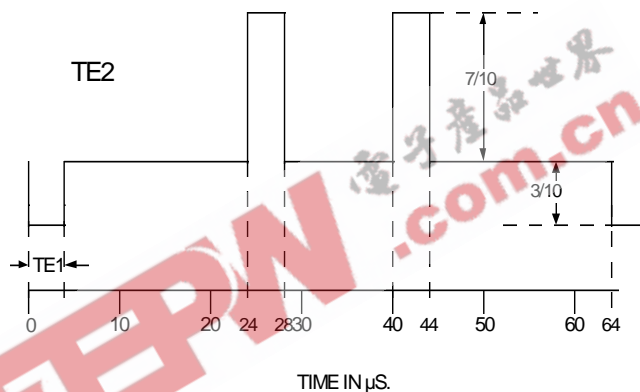

Figure 8. Test Pattern Generator

16.10 Sound Section

The oscillator is fully integrated and does not require any external components. An internal low-pass filter and matched structure provide very low harmonics levels.

The sound modulator system consists of an FM modulator incorporating the sound subcarrier oscillator. The audio input signal is AC-coupled into the amplifier, which then drives the modulator. The audio pre-emphasis circuit is a high-pass filter with an external capacitor and an internal resistor (106K Ohms typical).

The recommended capacitor value for BG standard (with a time constant of 50 μS) is 470 pF.

The recommended capacitor value for M/N standard (with a time constant of 75 μS) is 750 pF.

To increase the audio bandwidth at low frequencies it is possible to change the sound PLL loop filter. The recommended values are 220 nF and 22 nF. To increase the bandwidth at low frequencies (lower than 50 Hz) it is possible to use larger loop filter capacitor values. This will give a lower cut off frequency. In this case it is necessary to calculate the new values of the loop filter according to the required Q factor and loop bandwidth. This is described in the following figure:

Sound PLL loop filter calculation

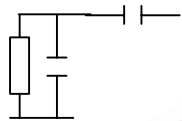

Loop filter equation : $\omega_0 = \sqrt{\frac{Kpd * Kosc}{N * C1}}$, $Q = \frac{1}{R * C1 * \omega_0}$, with :

- ω_0 = 3dB cut off frequency
- Kpd = 1uA : Phase detector current
- Kosc = 5MHz/V : sound oscillator slope (in fact Kosc=40MHz/prescaler divider =8) This gives 5 MHz/V
- N = sound divider ratio
- Q = quality factor

C2, added to minimize glitches, is usually set to one tenth the size of C1.

Example :

Fref=31.25KHz → N=5.5MHz / 31.25KHz = 176

Assuming C1= 220 nF, then ω_0 = 360 rad, and fo= 57Hz

Q depends on the desired frequency response ; Choosing Q = 0.7 as a starting point, then R= 18 kΩ. The resistance acts directly on the factor quality and can be adjusted to create peaking on the low frequency range. It is recommended to adjust the value of R experimentally depending on the application and requirements. In the proposed application schematic a value of 15 kΩ has been chosen.

Figure 9. Sound PLL Loop Filter Calculation

17 High Speed I²C Compatible Bus

17.1 Specification Conditions

Unless otherwise specified, V_{cc}=5.0V, TA=25°C.

Electrical Characteristics	Symbol	Min	Typ	Max	Unit	Type
SDA / SCL output current at 0V		-5	-2	-	μA	A
SDA / SCL low input level	V _{IL}	-	-	1.5	V	B
SDA / SCL high input level	V _{IH}	2.1	-	-	V	B
SDA/SCL input current for input level from 0.4V to 0.3V _{cc}		-5	-	5	μA	C
SDA/SCL input level		0	-	V _{cc} +0,3	V	D
SDA/SCL capacitance		-	-	10	pF	C
ACK low output level (3 mA sinking current)		-	-	0.3	V	C
ACK low output level (9 mA sinking current)		-	-	0.8	V	C

Timing Characteristics	Symbol	Min	Typ	Max	Unit	Type
Bus clock frequency		0	-	800	kHz	C
Bus free time between stop and start	T _{buf}	200	-	-	ns	C
Setup time for start condition	T _{su;sta}	500	-	-	ns	C
Hold time for start condition	T _{hd;sta}	500	-	-	ns	C
Data setup time	T _{su;dat}	0	-	-	ns	C
Data hold time	T _{hd;dat}	0	-	-	ns	C
Setup time for stop condition	T _{su;sto}	500	-	-	ns	C
Hold time for stop condition	T _{hd;sto}	500	-	-	ns	C
Acknowledge propagation delay	T _{ack;low}	-	-	300	ns	C
SDA fall time at 3ma sink I and 130pF load		-	-	50	ns	C
SDA fall time at 3ma sink I and 400pF load		-	-	80	ns	C
SDA rise time		-	-	300	ns	C
SCL fall/rise time		-	-	300	ns	C
Pulse width of spikes suppressed by the input filter		-	-	50	ns	C

17.2 Timing Definitions

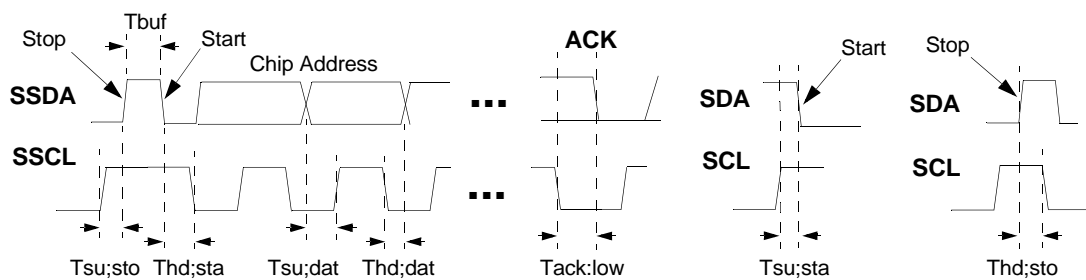

Figure 10. SSDA/SSCL Timing

17.3 Level Definitions

SDA/SCL high and low levels are designed to be compatible with 0-5V and 0-3.3V SDA / SCL signals.

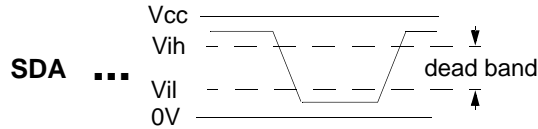

Figure 11. SDA/SCL Levels

17.4 High Speed I²C Compatible Bus Format

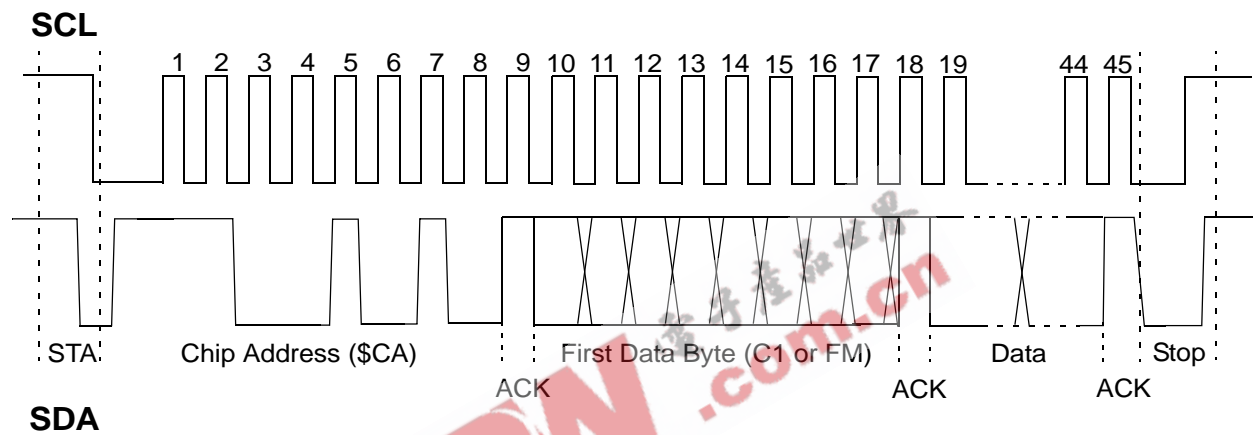

Figure 12. I²C Bus Timing

17.5 I²C Write Mode Format and Bus Receiver

The bus receiver operates the I²C compatible data format. The chip address (I²C bus) is as follows.

Table 9. Chip Address (I²C Bus)

1 1 0 0 1 0 1 0 (ACK) = \$CA (hex) in write mode
--

In write mode, each ninth data bit (bits 9, 18, 27, 36, and 45) is an acknowledge bit (ACK) during which the MCU sends a logic 1 and the Modulator circuit answers on the data line by pulling it low. Besides the chip address, the circuit needs two or four data bytes for operation. The following sequences of data bytes are the permitted incoming information:

Table 10. Permitted Data Bytes (Incoming Information)

Example 1	STA	CA	C1	C0	STO		
Example 2	STA	CA	FM	FL	STO		
Example 3	STA	CA	C1	C0	FM	FL	STO
Example 4	STA	CA	FM	FL	C1	C0	STO
Note:							
STA = Start condition				CA = Chip Address			

Table 10. Permitted Data Bytes (Incoming Information)

FM = Frequency information, high order bits	FL = Frequency information, low order bits
C1 = Control information, high order bits	CO = Control information, low order bits
STO = Stop condition	

After the chip address, two or four data bytes may be received.

- If three data bytes are received, the third one is ignored.
- If five or more data bytes are received, the fifth and following ones are ignored, and the last ACK pulse is sent at the end of the fourth data byte.

The first and third data bytes contain a function bit, which lets the IC distinguish between frequency information and control information. If the function bit is a logic 1, the two following bytes contain control information. The first data byte after the chip address, may be byte CO or byte FM. The two bytes of frequency information are preceded by a logic 0.

17.6 I²C Read Mode Format

The chip address (I²C) is:

Table 11. Chip Address (I²C Read Mode)

1 1 0 0 1 0 1 1 (ACK) = \$CB (hex) in read mode

The incoming information consists of the read mode chip address byte. The device then answers with an ACK followed by one byte containing three bits of status information. No acknowledge is answered by the modulator after this byte.

18 Pin Circuit Schematics

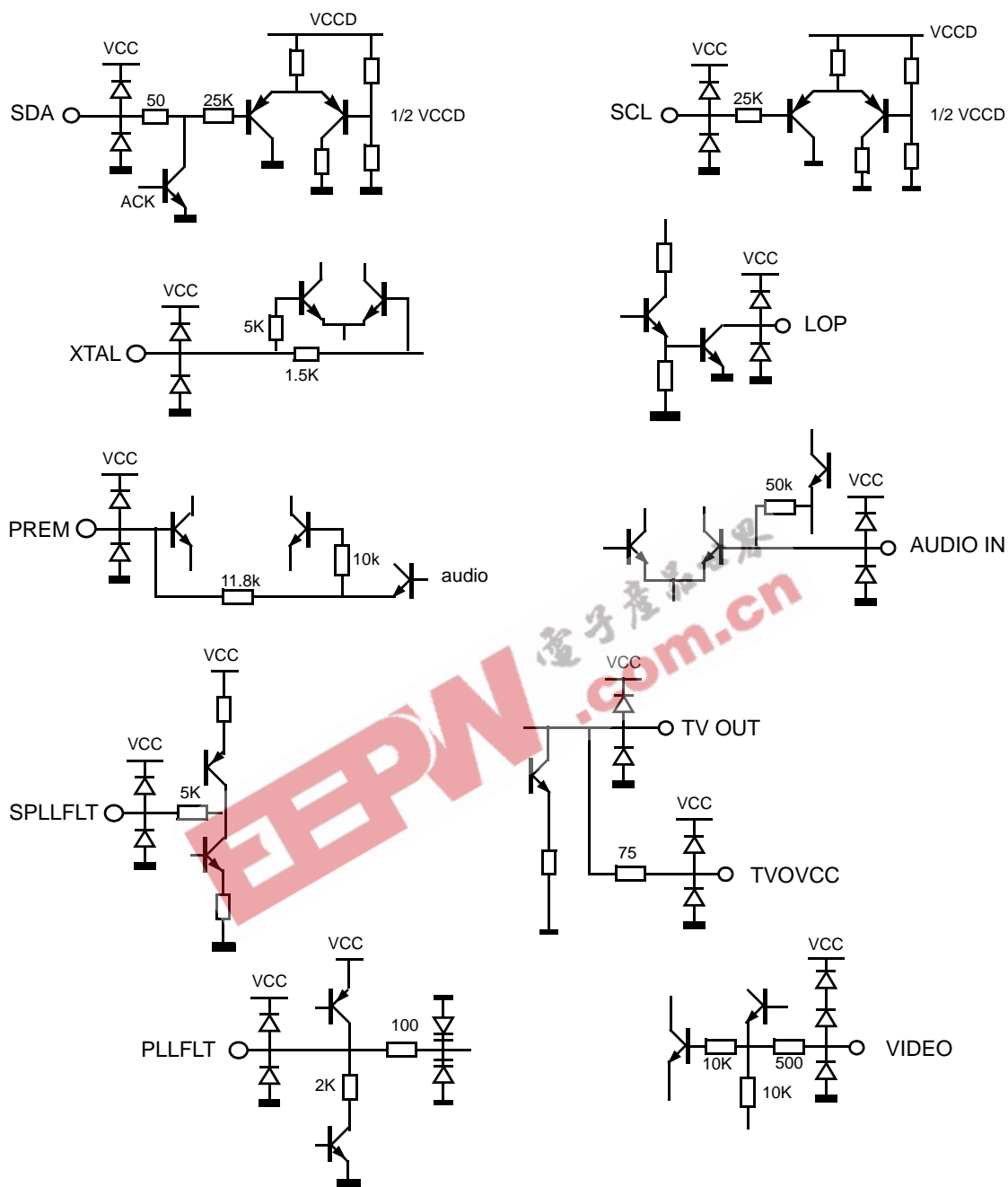

Figure 13. Pin Circuit Schematics

19 Application Diagram

This document contains information on a new product under development.
Motorola reserves the right to change or discontinue this product without notice.

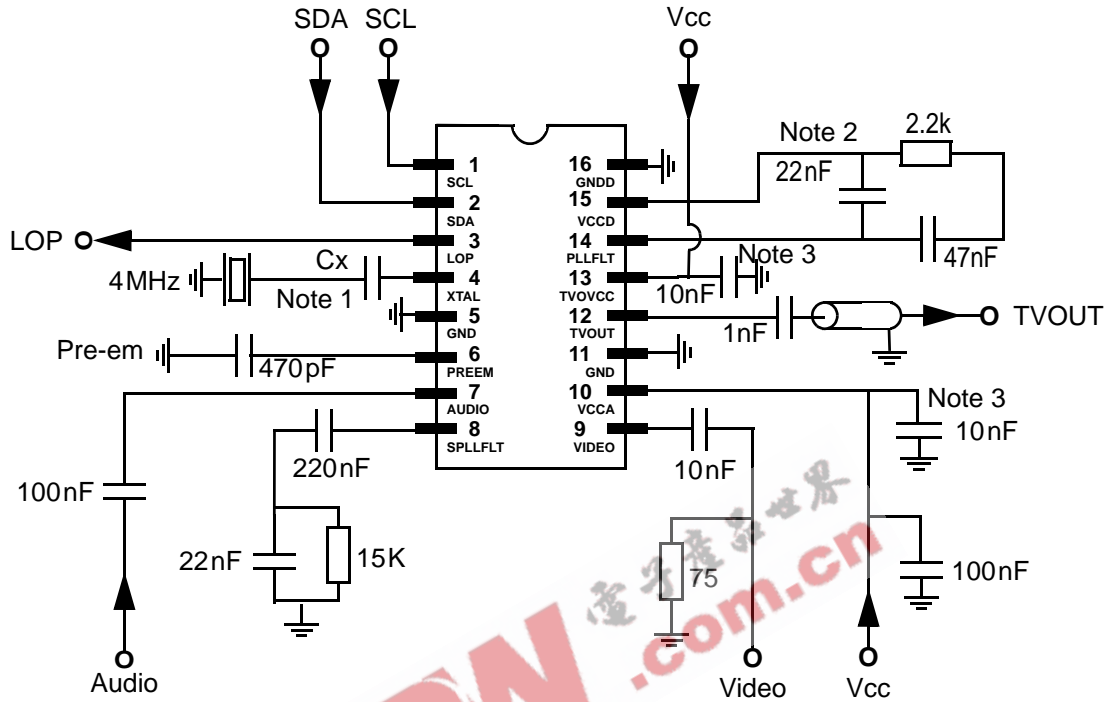

Figure 14. Proposed Application Schematic

- Note:** 1. Cx value depends on crystal characteristics. Cx = 27pF on Motorola application board.
Note: 2. RF PLL Loop Filter components at pin 14 must be as close as possible to Vccd at pin 15.
Note: 3. Supply voltage decoupling capacitors must be as close as possible to ground.

20 Evaluation Board Layout and Schematic

20.1 Evaluation Board Layout

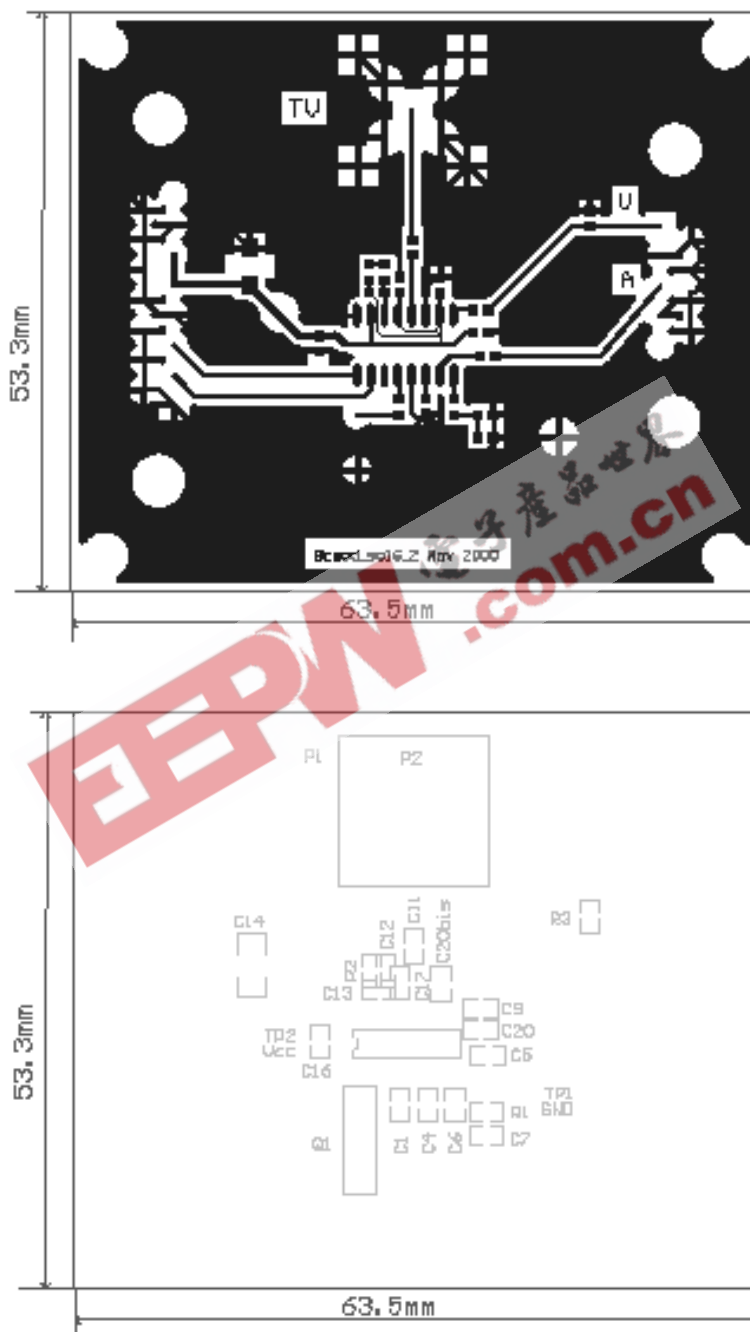

Figure 15. Evaluation Board PCB Layout

20.2 Evaluation Board Schematic

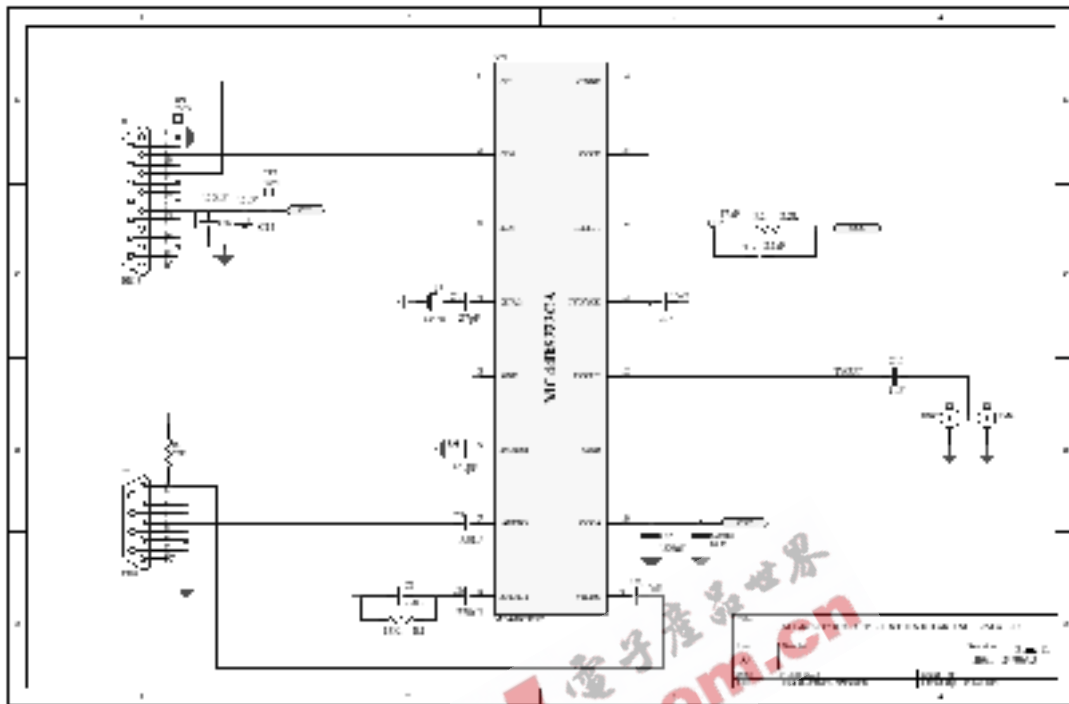

Figure 16. Evaluation Board Schematic

21 Packaging Instructions

Tape and reel packaging per 12MRH00360A issue Y with the following conditions applicable for Dual In-Line SOP (SOIC) package.

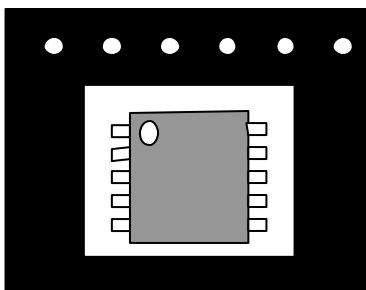
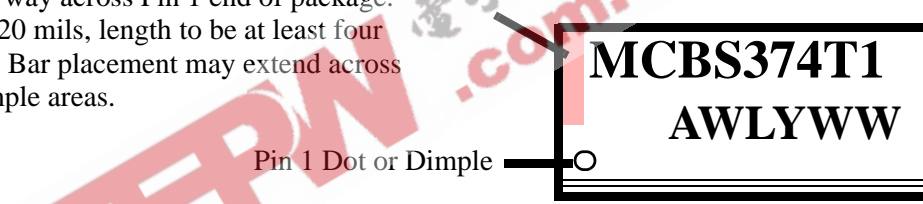

Figure 17. Dual In-line SOP (SOIC)

Component Orientation: Arrange parts with the pin 1 side closest to the tape's round sprocket holes on the tape's trailing edge.

22 Marking Instructions

Bar marked part way across Pin 1 end of package.
Bar width 10 to 20 mils, length to be at least four times Bar width. Bar placement may extend across chamfer and dimple areas.

- 
- 1st line:
MCBS374T1 (Part number coded on 9 digits)
 - 2nd line:
Assembly site code AW (2 digits) followed by the wafer lot code L (1 digit), year Y (1 digit) and work week WW (2 digits)

Bar marked part way across Pin 1 end of package.
Bar width 10 to 20 mils, length to be at least four times Bar width. Bar placement may extend across chamfer and dimple areas.

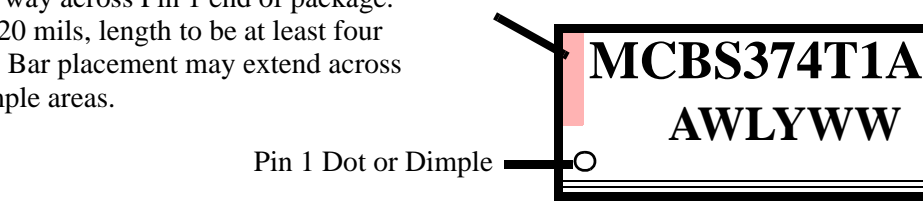
- 
- 1st line:
MCBS374T1A (Part number coded on 10 digits)
 - 2nd line:
Assembly site code AW (2 digits) followed by the wafer lot code L (1 digit), year Y (1 digit) and work week WW (2 digits)

Freescale Semiconductor, Inc.

23 Case Outline

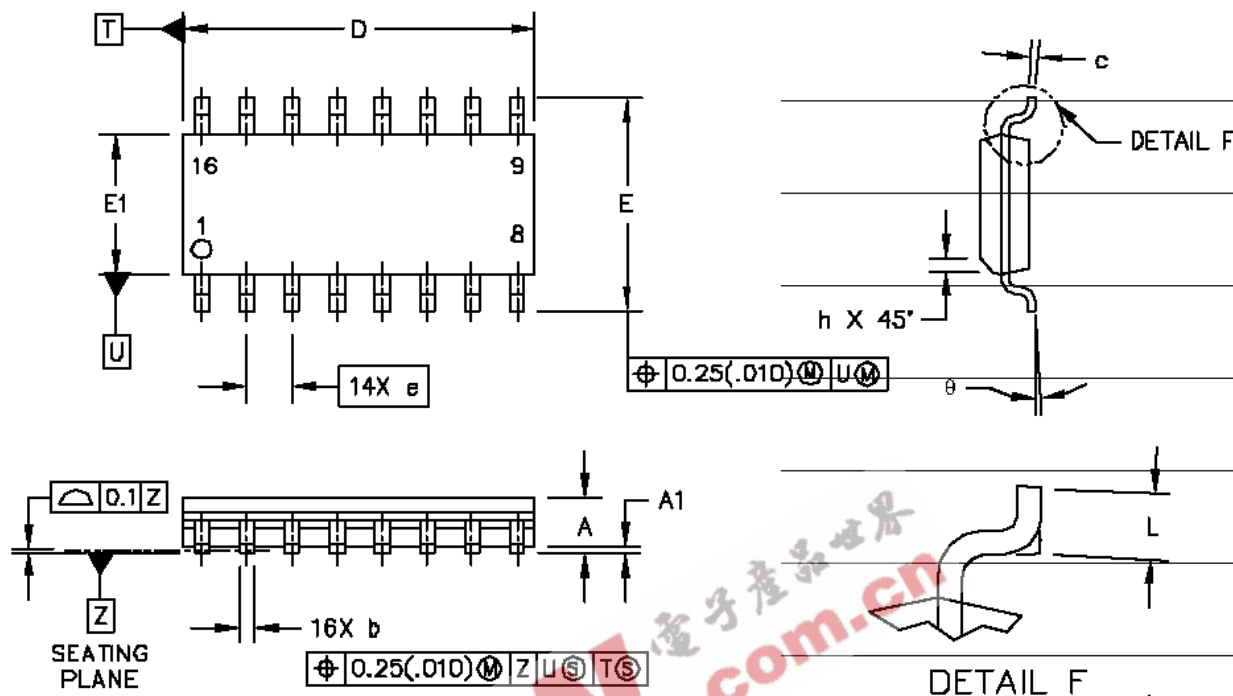

Dim	Millimeters		Inches	
	Min	Max	Min	Max
A	1.35	1.75	0.054	0.068
A1	0.1	0.25	0.004	0.009
D	9.8	10	0.385	0.393
E	5.8	6.2	0.229	0.244
E1	3.8	4	0.150	0.157
b	0.35	0.49	0.014	0.019
c	0.19	0.25	0.008	0.009
e	1.27 BSC		0.050 BSC	
L	0.4	1.25	0.016	0.049
h	0.25	0.5	0.010	0.019
Q	0°	7°	0°	7°

Note: 1. Dimensions and Tolerances per ASME Y14.5M, 1994.

Note: 2. Controlling dimension: Millimeters.

Note: 3. Dimension D and E1 do not include mold protrusion.

Note: 4. Maximum mold protrusion 0.15 (0.006) per side.

Note: 5. Dimension b does not include Dambar protrusion. Allowable Dambar protrusion shall be 0.127 (0.005) total in excess of the b dimension at maximum material condition.

Figure 18. SO16NB package

Freescale Semiconductor, Inc.

Freescale Semiconductor, Inc.

EEPW 电子产品世界
.com.cn

MC44BS374T1/374T1A

**For More Information On This Product,
Go to: www.freescale.com**