

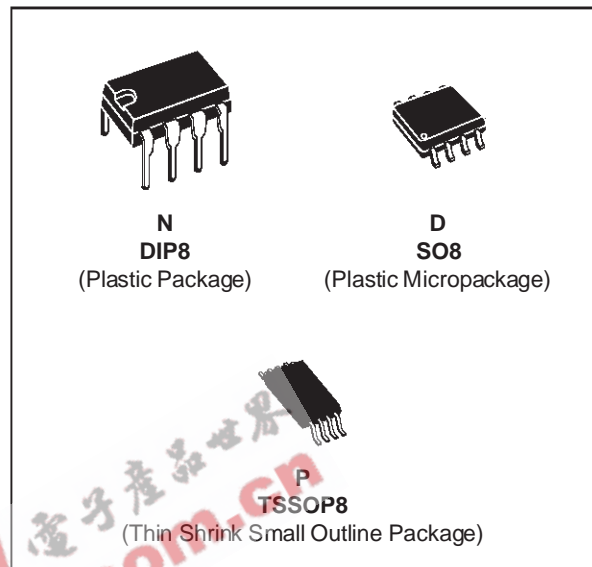

# MC4558

## WIDE BANDWIDTH DUAL BIPOLAR OPERATIONAL AMPLIFIERS

- INTERNALLY COMPENSATED
- SHORT-CIRCUIT PROTECTION
- GAIN AND PHASE MATCH BETWEEN AMPLIFIERS
- LOW POWER CONSUMPTION
- PIN TO PIN COMPATIBLE WITH MC1458/LM358
- GAIN BANDWIDTH PRODUCT (at 100kHz) 5.5MHz



### DESCRIPTION

The MC4558 is a high performance monolithic dual operational amplifier.

The circuit combines all the outstanding features of the MC1458 and, in addition, possesses three times the unity gain bandwidth of the industry standard.

### ORDER CODES

Part Number	Temperature Range	Package		
		N	D	P
MC4558C	0°C, +70°C	•	•	•
MC4558I	-40°C, +105°C	•	•	•

Example : MC4558CN

### PIN CONNECTIONS (top view)

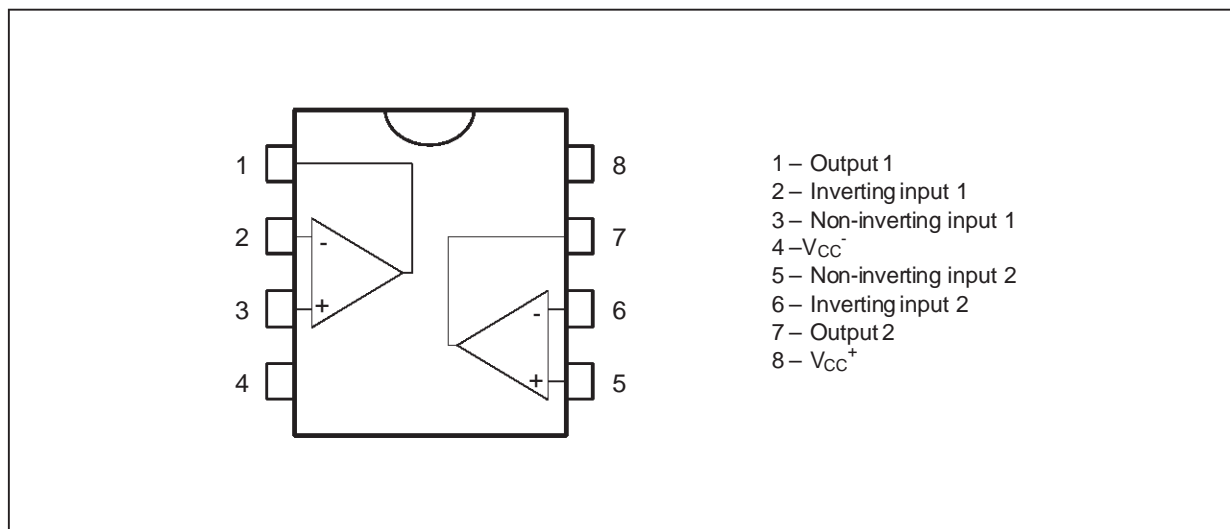

SCHMATIC DIAGRAM (1/2 MC4558)

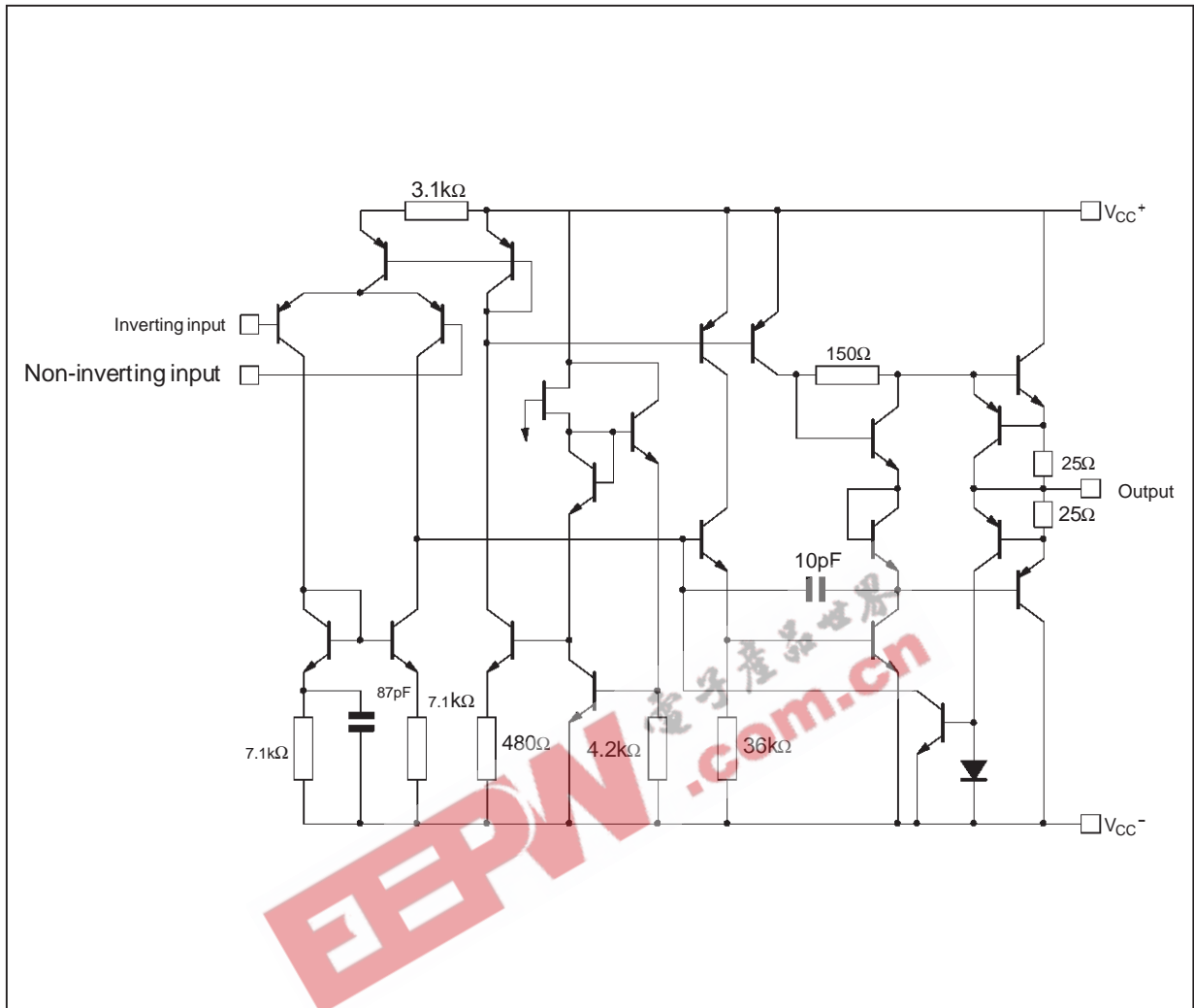

ABSOLUTE MAXIMUM RATINGS

Symbol	Parameter	MC4558I	MC4558C	Unit
$V_{CC}$	Supply Voltage	$\pm 22$	$\pm 22$	V
$V_i$	Input Voltage	$\pm 15$	$\pm 15$	V
$V_{id}$	Differential Input Voltage	$\pm 30$	$\pm 30$	V
$P_{tot}$	Power Dissipation	680	680	mW
	Output Short-circuit Duration	Infinite		
$T_{oper}$	Operating Free-air Temperature Range	-40 to +105	0 to +70	$^{\circ}C$
$T_{stg}$	Storage Temperature Range	-65 to +150	-65 to +150	$^{\circ}C$



TRANSIENT RESPONSE TEST CIRCUIT

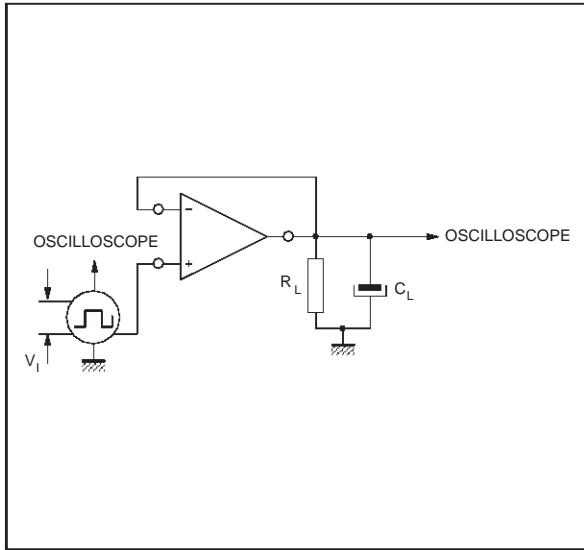

OPEN LOOP FREQUENCY RESPONSE

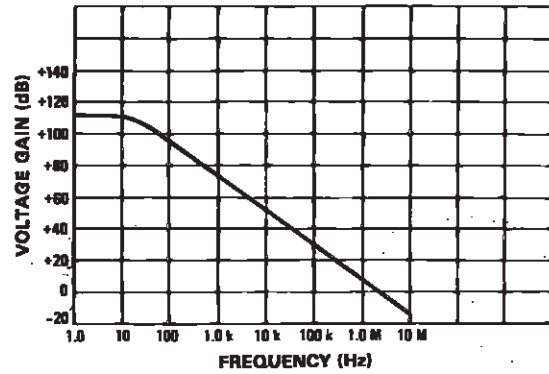

PHASE MARGIN VERSUS FREQUENCY

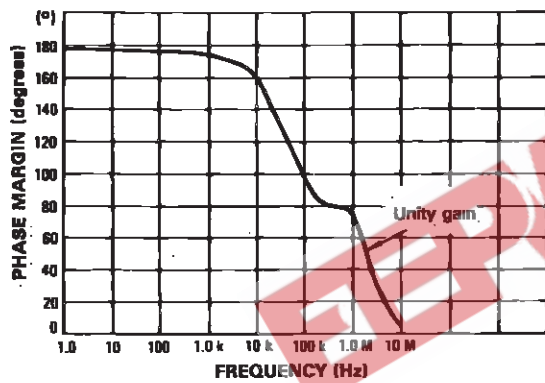

POSITIVE OUTPUT VOLTAGE SWING VERSUS LOAD RESISTANCE

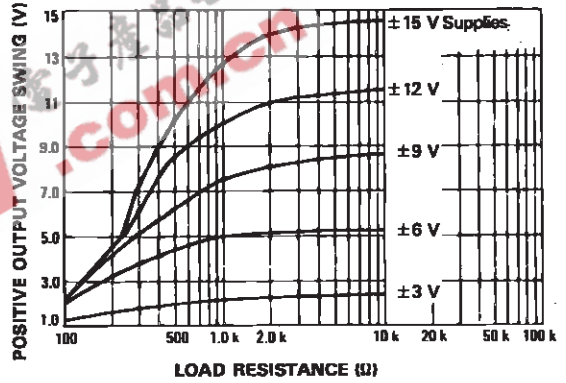

NEGATIVE OUTPUT VOLTAGE SWING VERSUS LOAD RESISTANCE

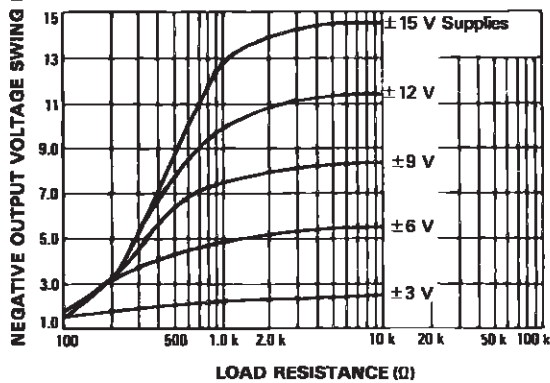

POWER BANDWIDTH (Large signal swing versus frequency)

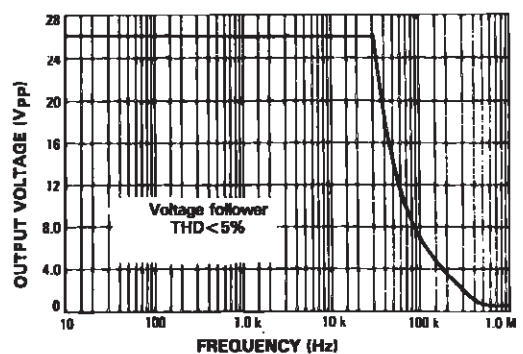

## PACKAGE MECHANICAL DATA

8 PINS – PLASTIC DIP

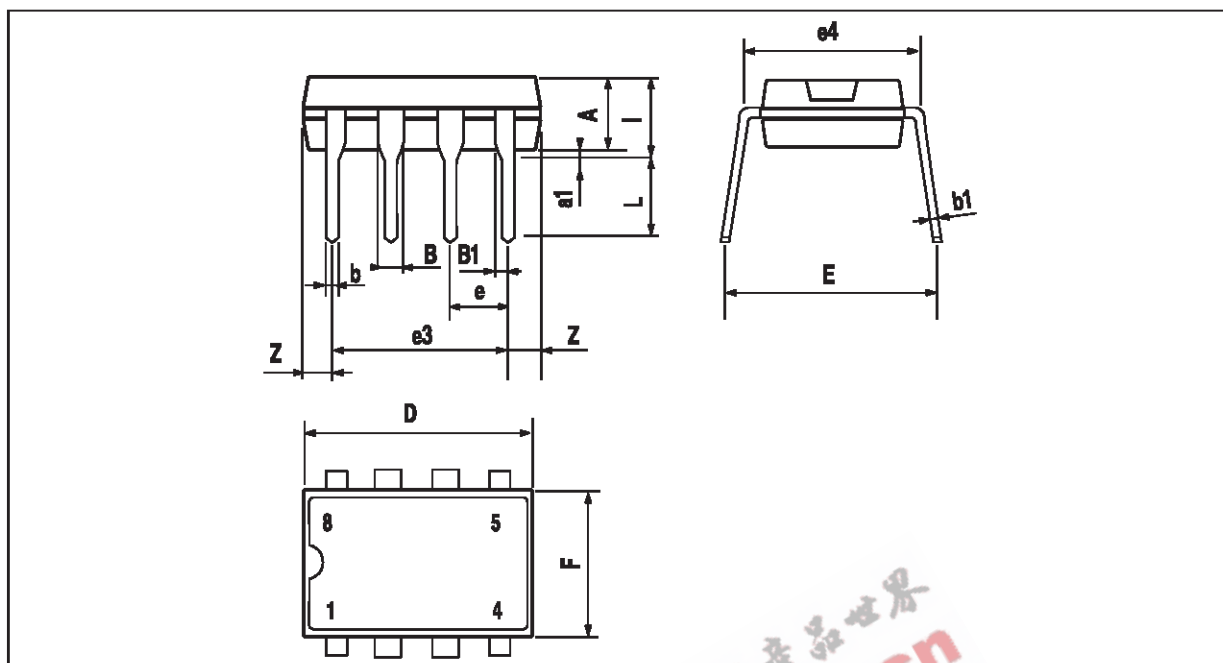

PM-DIP8EFS

Dimensions	Millimeters			Inches		
	Min.	Typ.	Max.	Min.	Typ.	Max.
A		3.32			0.131	
a1	0.51			0.020		
B	1.15		1.65	0.045		0.065
b	0.356		0.55	0.014		0.022
b1	0.204		0.304	0.008		0.012
D			10.92			0.430
E	7.95		9.75	0.313		0.384
e		2.54			0.100	
e3		7.62			0.300	
e4		7.62			0.300	
F			6.6			0.260
i			5.08			0.200
L	3.18		3.81	0.125		0.150
Z			1.52			0.060

DIP8.TBL

# MC4558

## PACKAGE MECHANICAL DATA 8 PINS – PLASTIC MICROPACKAGE (SO)

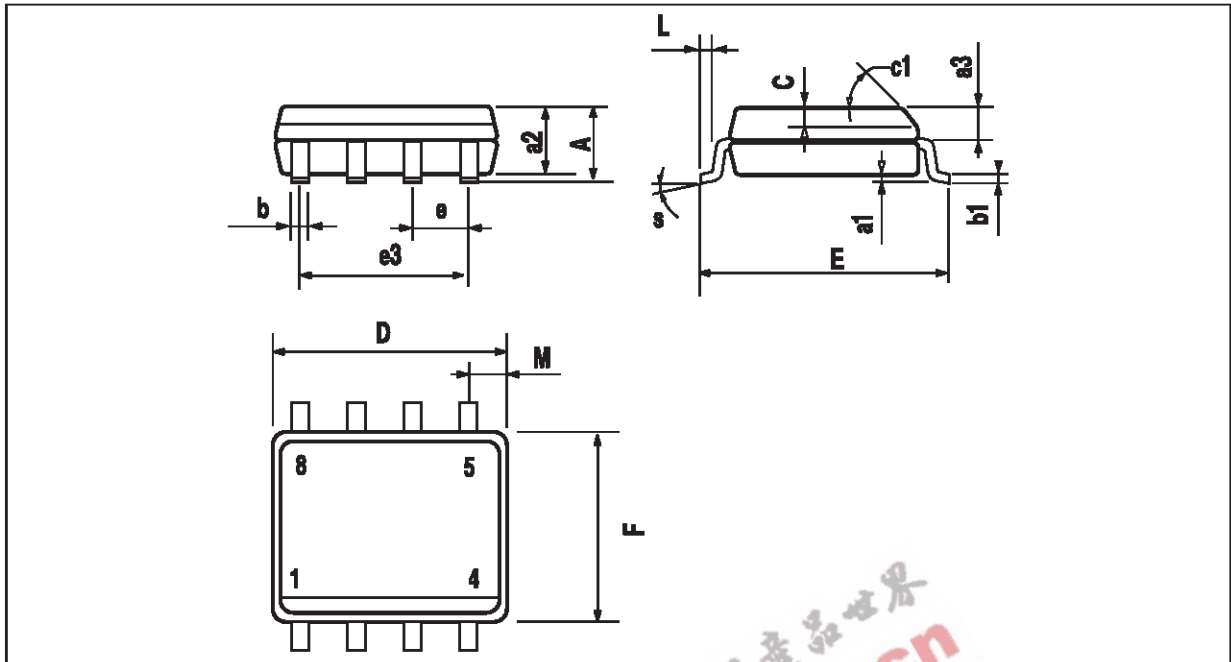

PM-SO8.EPS

Dimensions	Millimeters			Inches		
	Min.	Typ.	Max.	Min.	Typ.	Max.
A			1.75			0.069
a1	0.1		0.25	0.004		0.010
a2			1.65			0.065
a3	0.65		0.85	0.026		0.033
b	0.35		0.48	0.014		0.019
b1	0.19		0.25	0.007		0.010
C	0.25		0.5	0.010		0.020
c1	45° (typ.)					
D	4.8		5.0	0.189		0.197
E	5.8		6.2	0.228		0.244
e		1.27			0.050	
e3		3.81			0.150	
F	3.8		4.0	0.150		0.157
L	0.4		1.27	0.016		0.050
M			0.6			0.024
S	8° (max.)					

SO8.TBL

## PACKAGE MECHANICAL DATA

## 8 PINS – THIN SHRINK SMALL OUTLINE PACKAGE

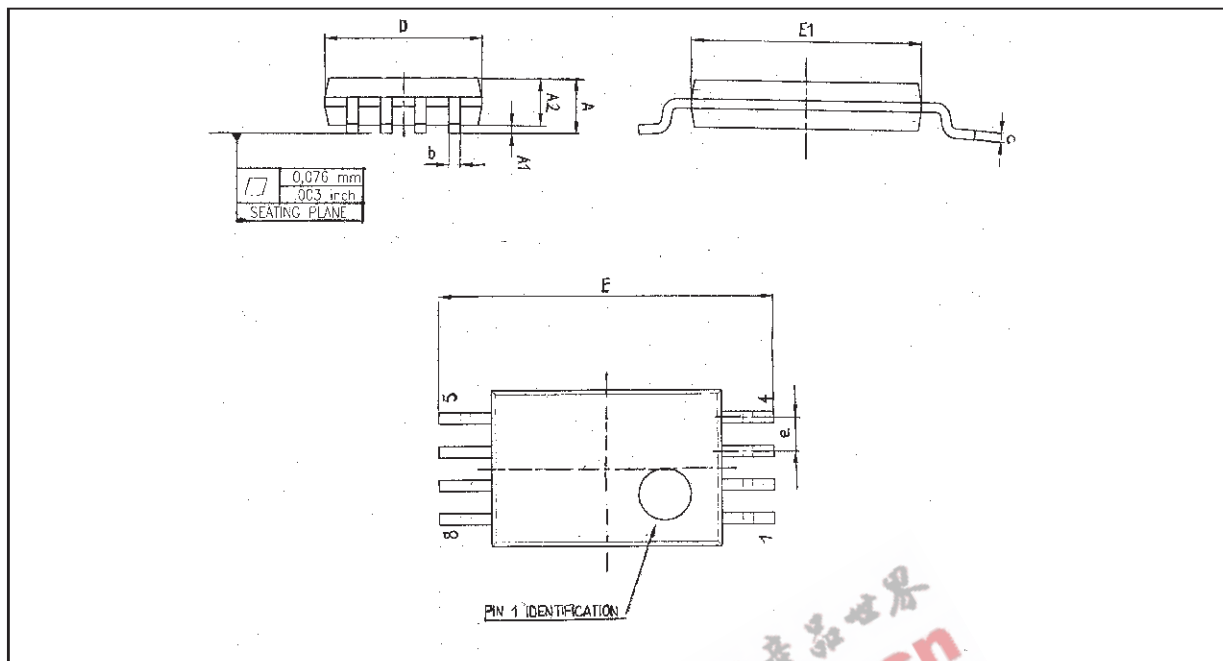

Dim.	Millimeters			Inches		
	Min.	Typ.	Max.	Min.	Typ.	Max.
A			1.20			0.05
A1	0.05		0.15	0.01		0.006
A2	0.80	1.00	1.05	0.031	0.039	0.041
b	0.19		0.30	0.007		0.15
c	0.09		0.20	0.003		0.012
D	2.90	3.00	3.10	0.114	0.118	0.122
E		6.40			0.252	
E1	4.30	4.40	4.50	0.169	0.173	0.177
e		0.65			0.025	
k	0°		8°	0°		8°
l	0.50	0.60	0.75	0.09	0.0236	0.030

Information furnished is believed to be accurate and reliable. However, STMicroelectronics assumes no responsibility for the consequences of use of such information nor for any infringement of patents or other rights of third parties which may result from its use. No license is granted by implication or otherwise under any patent or patent rights of STMicroelectronics. Specifications mentioned in this publication are subject to change without notice. This publication supersedes and replaces all information previously supplied. STMicroelectronics products are not authorized for use as critical components in life support devices or systems without express written approval of STMicroelectronics.

© The ST logo is a trademark of STMicroelectronics

© 1998 STMicroelectronics – Printed in Italy – All Rights Reserved  
STMicroelectronics GROUP OF COMPANIES

Australia - Brazil - Canada - China - France - Germany - Italy - Japan - Korea - Malaysia - Malta - Mexico - Morocco  
The Netherlands - Singapore - Spain - Sweden - Switzerland - Taiwan - Thailand - United Kingdom - U.S.A.

ORDER CODE :