

# MC74HC1G04

## Single Inverter

The MC74HC1G04 is a high speed CMOS inverter fabricated with silicon gate CMOS technology.

The internal circuit is composed of multiple stages, including a buffer output which provides high noise immunity and stable output.

The MC74HC1G04 output drive current is 1/2 compared to MC74HC series.

- High Speed:  $t_{PD} = 7 \text{ ns}$  (Typ) at  $V_{CC} = 5 \text{ V}$
- Low Power Dissipation:  $I_{CC} = 1 \mu\text{A}$  (Max) at  $T_A = 25^\circ\text{C}$
- High Noise Immunity
- Balanced Propagation Delays ( $t_{pLH} = t_{pHL}$ )
- Symmetrical Output Impedance ( $I_{OH} = I_{OL} = 2 \text{ mA}$ )
- Chip Complexity: FET = 105
- Pb-Free Packages are Available

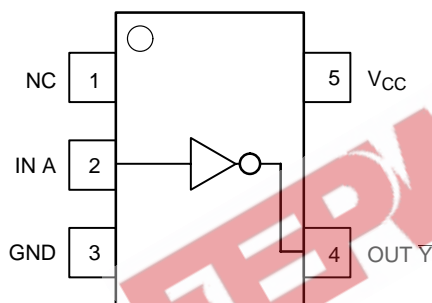

Figure 1. Pinout (Top View)

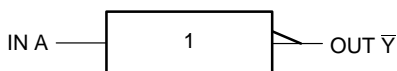

Figure 2. Logic Symbol



ON Semiconductor®

<http://onsemi.com>

### MARKING DIAGRAMS



SC70-5/SC-88A/SOT-353  
DF SUFFIX  
CASE 419A

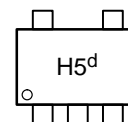

Pin 1



SOT23-5/TSOP-5/SC59-5  
DT SUFFIX  
CASE 483

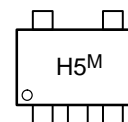

Pin 1

d = Date Code  
M = Month Code

### PIN ASSIGNMENT

| PIN ASSIGNMENT |               |
|----------------|---------------|
| 1              | NC            |
| 2              | IN A          |
| 3              | GND           |
| 4              | OUT $\bar{Y}$ |
| 5              | $V_{CC}$      |

### FUNCTION TABLE

| Input A | Output $\bar{Y}$ |
|---------|------------------|
| L       | H                |
| H       | L                |

### ORDERING INFORMATION

See detailed ordering and shipping information in the package dimensions section on page 4 of this data sheet.

# MC74HC1G04

## MAXIMUM RATINGS

| Symbol               | Parameter                                       | Value  | Unit                   |
|----------------------|---|--|------------------------|
| V <sub>CC</sub>      | DC Supply Voltage                               | - 0.5 to + 7.0   | V                      |
| V <sub>IN</sub>      | DC Input Voltage                                | - 0.5 to V <sub>CC</sub> + 0.5   | V                      |
| V <sub>OUT</sub>     | DC Output Voltage                               | - 0.5 to V <sub>CC</sub> + 0.5   | V                      |
| I <sub>IK</sub>      | DC Input Diode Current                          | ± 20   | mA                     |
| I <sub>OK</sub>      | DC Output Diode Current                         | ± 20   | mA                     |
| I <sub>OUT</sub>     | DC Output Sink Current                          | ± 12.5   | mA                     |
| I <sub>CC</sub>      | DC Supply Current per Supply Pin                | ± 25   | mA                     |
| T <sub>STG</sub>     | Storage Temperature Range                       | - 65 to + 150  | °C                     |
| T <sub>L</sub>       | Lead Temperature, 1 mm from Case for 10 Seconds | 260  | °C                     |
| T <sub>J</sub>       | Junction Temperature Under Bias                 | + 150  | °C                     |
| θ <sub>JA</sub>      | Thermal Resistance                              | SC70-5/SC-88A (Note 1)<br>TSOP-5<br>350<br>230                                       | °C/W                   |
| P <sub>D</sub>       | Power Dissipation in Still Air at 85°C          | SC70-5/SC-88A<br>TSOP-5<br>150<br>200  | mW                     |
| MSL                  | Moisture Sensitivity                            | Level 1  |                        |
| F <sub>R</sub>       | Flammability Rating                             | Oxygen Index: 28 to 34   | UL 94 V-0 @ 0.125 in   |
| V <sub>ESD</sub>     | ESD Withstand Voltage                           | Human Body Model (Note 2)<br>Machine Model (Note 3)<br>Charged Device Model (Note 4) | > 2000<br>> 200<br>N/A |
| I <sub>LATCHUP</sub> | Latchup Performance                             | Above V <sub>CC</sub> and Below GND at 125°C (Note 5)                                | ± 500<br>mA            |

Maximum ratings are those values beyond which device damage can occur. Maximum ratings applied to the device are individual stress limit values (not normal operating conditions) and are not valid simultaneously. If these limits are exceeded, device functional operation is not implied, damage may occur and reliability may be affected.

1. Measured with minimum pad spacing on an FR4 board, using 10 mm-by-1 inch, 2 ounce copper trace with no air flow.
2. Tested to EIA/JESD22-A114-A.
3. Tested to EIA/JESD22-A115-A.
4. Tested to JESD22-C101-A.
5. Tested to EIA/JESD78.

## RECOMMENDED OPERATING CONDITIONS

| Symbol                          | Parameter                   | Min  | Max                            | Unit |
|---------------------------------|-----------------------------|--|--------------------------------|------|
| V <sub>CC</sub>                 | DC Supply Voltage           | 2.0  | 6.0                            | V    |
| V <sub>IN</sub>                 | DC Input Voltage            | 0.0  | V <sub>CC</sub>                | V    |
| V <sub>OUT</sub>                | DC Output Voltage           | 0.0  | V <sub>CC</sub>                | V    |
| T <sub>A</sub>                  | Operating Temperature Range | - 55   | + 125                          | °C   |
| t <sub>r</sub> , t <sub>f</sub> | Input Rise and Fall Time    | V <sub>CC</sub> = 2.0 V<br>V <sub>CC</sub> = 3.0 V<br>V <sub>CC</sub> = 4.5 V<br>V <sub>CC</sub> = 6.0 V | 0<br>1000<br>600<br>500<br>400 | ns   |

## DEVICE JUNCTION TEMPERATURE VERSUS TIME TO 0.1% BOND FAILURES

| Junction Temperature °C | Time, Hours | Time, Years |
|-------------------------|-------------|-------------|
| 80                      | 1,032,200   | 117.8       |
| 90                      | 419,300     | 47.9        |
| 100                     | 178,700     | 20.4        |
| 110                     | 79,600      | 9.4         |
| 120                     | 37,000      | 4.2         |
| 130                     | 17,800      | 2.0         |
| 140                     | 8,900       | 1.0         |

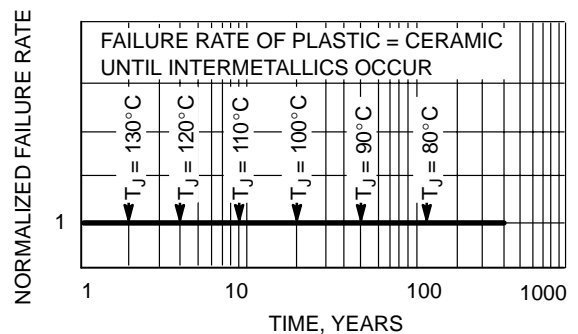

Figure 3. Failure Rate vs. Time Junction Temperature

# MC74HC1G04

## DC ELECTRICAL CHARACTERISTICS

| Symbol          | Parameter   | Test Conditions  | V <sub>CC</sub><br>(V)        | T <sub>A</sub> = 25°C          |                 |                                  | T <sub>A</sub> ≤ 85°C                    |      | -55°C ≤ T <sub>A</sub> ≤ 125°C |      | Unit |  |      |    |
|-----------------|---|--|-------------------------------|--------------------------------|-----------------|----------------------------------|--|------|--------------------------------|------|------|--|------|----|
|                 |   |  |                               | Min                            | Typ             | Max                              | Min                                      | Max  | Min                            | Max  |      |  |      |    |
| V <sub>IH</sub> | Minimum High-Level Input Voltage  |  | 2.0                           | 1.5                            |                 |                                  | 1.5                                      |      | 1.5                            |      | V    |  |      |    |
|                 |   |  | 3.0                           | 2.1                            |                 |                                  | 2.1                                      |      | 2.1                            |      |      |  |      |    |
|                 |   |  | 4.5                           | 3.15                           |                 |                                  | 3.15                                     |      | 3.15                           |      |      |  |      |    |
|                 |   |  | 6.0                           | 4.20                           |                 |                                  | 4.20                                     |      | 4.20                           |      |      |  |      |    |
| V <sub>IL</sub> | Maximum Low-Level Input Voltage   |  | 2.0                           |                                |                 | 0.5                              |  | 0.5  |                                | 0.5  | V    |  |      |    |
|                 |   |  | 3.0                           |                                |                 | 0.9                              |  | 0.9  |                                | 0.9  |      |  |      |    |
|                 |   |  | 4.5                           |                                |                 | 1.35                             |  | 1.35 |                                | 1.35 |      |  |      |    |
|                 |   |  | 6.0                           |                                |                 | 1.80                             |  | 1.80 |                                | 1.80 |      |  |      |    |
| V <sub>OH</sub> | Minimum High-Level Output Voltage<br>V <sub>IN</sub> = V <sub>IH</sub> or V <sub>IL</sub> | V <sub>IN</sub> = V <sub>IH</sub> or V <sub>IL</sub><br>I <sub>OH</sub> = -20 μA | 2.0                           | 1.9                            | 2.0             |                                  | 1.9                                      |      | 1.9                            |      | V    |  |      |    |
|                 |   |  | 3.0                           | 2.9                            | 3.0             |                                  | 2.9                                      |      | 2.9                            |      |      |  |      |    |
|                 |   | 4.5  | 4.4                           | 4.5                            |                 | 4.4                              |  | 4.4  |                                | 4.4  |      |  |      |    |
|                 |   | 6.0  | 5.9                           | 6.0                            |                 | 5.9                              |  | 5.9  |                                | 5.9  |      |  |      |    |
| V <sub>OL</sub> | Maximum Low-Level Output Voltage<br>V <sub>IN</sub> = V <sub>IH</sub> or V <sub>IL</sub>  | V <sub>IN</sub> = V <sub>IH</sub> or V <sub>IL</sub><br>I <sub>OL</sub> = 20 μA  | 2.0                           |                                | 0.0             | 0.1                              |  | 0.1  |                                | 0.1  | V    |  |      |    |
|                 |   |  | 3.0                           |                                | 0.0             | 0.1                              |  | 0.1  |                                | 0.1  |      |  |      |    |
|                 |   | 4.5  |                               | 0.0                            | 0.1             |                                  | 0.1                                      |      | 0.1                            |      |      |  |      |    |
|                 |   | 6.0  |                               | 0.0                            | 0.1             |                                  | 0.1                                      |      | 0.1                            |      |      |  |      |    |
| V <sub>OL</sub> | Maximum Low-Level Output Voltage<br>V <sub>IN</sub> = V <sub>IH</sub> or V <sub>IL</sub>  | V <sub>IN</sub> = V <sub>IH</sub> or V <sub>IL</sub><br>I <sub>OL</sub> = 2 mA   | 4.5                           |                                | 0.17            | 0.26                             |  | 0.33 |                                | 0.40 | V    |  |      |    |
|                 |   |  | 6.0                           |                                | 0.18            | 0.26                             |  | 0.33 |                                | 0.40 |      |  |      |    |
|                 |   | I <sub>IN</sub>  | Maximum Input Leakage Current | V <sub>IN</sub> = 6.0 V or GND | 6.0             |                                  |  | ±0.1 |                                | ±1.0 |      |  | ±1.0 | μA |
|                 |   |  |                               |                                | I <sub>CC</sub> | Maximum Quiescent Supply Current | V <sub>IN</sub> = V <sub>CC</sub> or GND | 6.0  |                                | 1.0  |      |  | 10   |    |

## AC ELECTRICAL CHARACTERISTICS (Input t<sub>r</sub> = t<sub>f</sub> = 6.0 ns)

| Symbol                                 | Parameter                                    | Test Conditions                                | T <sub>A</sub> = 25°C |     |     | T <sub>A</sub> ≤ 85°C |     | -55°C ≤ T <sub>A</sub> ≤ 125°C |     | Unit |
|--|--|--|-----------------------|-----|-----|-----------------------|-----|--------------------------------|-----|------|
|  |  |  | Min                   | Typ | Max | Min                   | Max | Min                            | Max |      |
| t <sub>PLH</sub> ,<br>t <sub>PHL</sub> | Maximum Propagation Delay, Input A or B to Y | V <sub>CC</sub> = 5.0 V C <sub>L</sub> = 15 pF |                       | 3.5 | 15  |                       | 20  |                                | 25  | ns   |
|  |  | V <sub>CC</sub> = 2.0 V C <sub>L</sub> = 50 pF |                       | 18  | 100 |                       | 125 |                                | 155 |      |
|  |  | V <sub>CC</sub> = 3.0 V                        |                       | 10  | 27  |                       | 35  |                                | 90  |      |
|  |  | V <sub>CC</sub> = 4.5 V                        |                       | 7   | 20  |                       | 25  |                                | 35  |      |
|  |  | V <sub>CC</sub> = 6.0 V                        |                       | 6   | 17  |                       | 21  |                                | 26  |      |
| t <sub>TLH</sub> ,<br>t <sub>THL</sub> | Output Transition Time                       | V <sub>CC</sub> = 5.0 V C <sub>L</sub> = 15 pF |                       | 3   | 10  |                       | 15  |                                | 20  | ns   |
|  |  | V <sub>CC</sub> = 2.0 V C <sub>L</sub> = 50 pF |                       | 25  | 125 |                       | 155 |                                | 200 |      |
|  |  | V <sub>CC</sub> = 3.0 V                        |                       | 16  | 35  |                       | 45  |                                | 60  |      |
|  |  | V <sub>CC</sub> = 4.5 V                        |                       | 11  | 25  |                       | 31  |                                | 38  |      |
|  |  | V <sub>CC</sub> = 6.0 V                        |                       | 9   | 21  |                       | 26  |                                | 32  |      |
| C <sub>IN</sub>                        | Maximum Input Capacitance                    |  |                       | 5   | 10  |                       | 10  |                                | 10  | pF   |

| C <sub>PD</sub> | Power Dissipation Capacitance (Note 6) | Typical @ 25°C, V <sub>CC</sub> = 5.0 V |  | pF |
|-----------------|--|---|--|----|
|                 |  | 10                                      |  |    |
|                 |  |   |  |    |

6. C<sub>PD</sub> is defined as the value of the internal equivalent capacitance which is calculated from the operating current consumption without load. Average operating current can be obtained by the equation: I<sub>CC(OPR)</sub> = C<sub>PD</sub> • V<sub>CC</sub> • f<sub>in</sub> + I<sub>CC</sub>. C<sub>PD</sub> is used to determine the no-load dynamic power consumption; P<sub>D</sub> = C<sub>PD</sub> • V<sub>CC</sub><sup>2</sup> • f<sub>in</sub> + I<sub>CC</sub> • V<sub>CC</sub>.

## MC74HC1G04

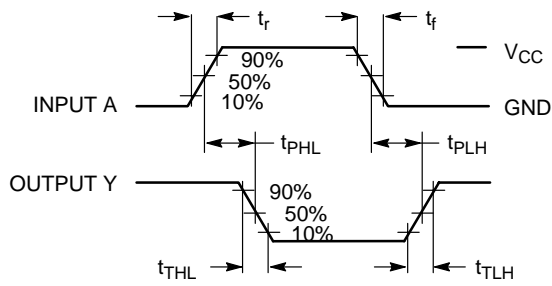
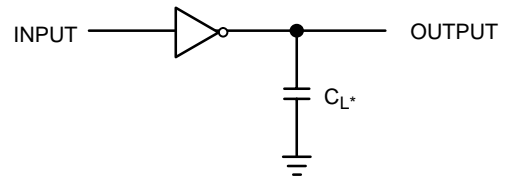

Figure 4. Switching Waveforms



\*Includes all probe and jig capacitance.  
A 1-MHz square input wave is recommended for propagation delay tests.

Figure 5. Test Circuit

### DEVICE ORDERING INFORMATION

| Device Order Number | Device Nomenclature     |                       |            |                 |                |                      | Package Type                    | Tape and Reel Size†     |
|---------------------|-------------------------|-----------------------|------------|-----------------|----------------|----------------------|---------------------------------|-------------------------|
|                     | Logic Circuit Indicator | Temp Range Identifier | Technology | Device Function | Package Suffix | Tape and Reel Suffix |                                 |                         |
| MC74HC1G04DFT1      | MC                      | 74                    | HC1G       | 08              | DF             | T1                   | SC70-5/SC-88A/SOT-353           | 178 mm (7 in) 3000 Unit |
| MC74HC1G04DFT1G     | MC                      | 74                    | HC1G       | 08              | DF             | T1                   | SC70-5/SC-88A/SOT-353 (Pb-Free) | 178 mm (7 in) 3000 Unit |
| MC74HC1G04DFT2      | MC                      | 74                    | HC1G       | 08              | DF             | T2                   | SC70-5/SC-88A/SOT-353           | 178 mm (7 in) 3000 Unit |
| MC74HC1G04DFT2G     | MC                      | 74                    | HC1G       | 08              | DF             | T2                   | SC70-5/SC-88A/SOT-353 (Pb-Free) | 178 mm (7 in) 3000 Unit |
| MC74HC1G04DTT1      | MC                      | 74                    | HC1G       | 08              | DT             | T1                   | SOT23-5/TSOP-5/SC59-5           | 178 mm (7 in) 3000 Unit |
| MC74HC1G04DTT1G     | MC                      | 74                    | HC1G       | 08              | DT             | T1                   | SOT23-5/TSOP-5/SC59-5 (Pb-Free) | 178 mm (7 in) 3000 Unit |

†For information on tape and reel specifications, including part orientation and tape sizes, please refer to our Tape and Reel Packaging Specifications Brochure, BRD8011/D.

# MC74HC1G04

## PACKAGE DIMENSIONS

SC70-5/SC-88A/SOT-353  
 DF SUFFIX  
 5-LEAD PACKAGE  
 CASE 419A-02  
 ISSUE G

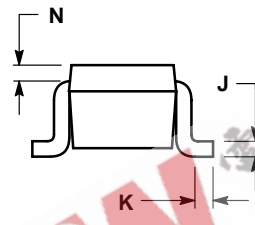
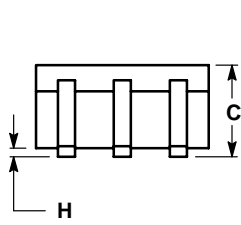
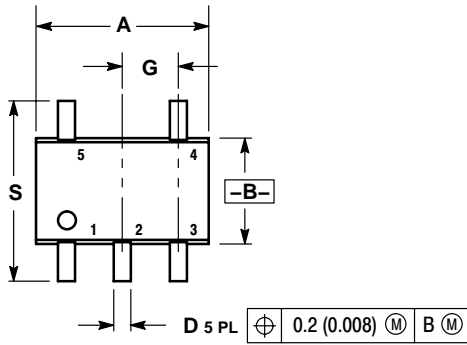

NOTES:

1. DIMENSIONING AND TOLERANCING PER ANSI Y14.5M, 1982.
2. CONTROLLING DIMENSION: INCH.
3. 419A-01 OBSOLETE. NEW STANDARD 419A-02.
4. DIMENSIONS A AND B DO NOT INCLUDE MOLD FLASH, PROTRUSIONS, OR GATE BURRS.

| DIM | INCHES    |       | MILLIMETERS |      |
|-----|-----------|-------|-------------|------|
|     | MIN       | MAX   | MIN         | MAX  |
| A   | 0.071     | 0.087 | 1.80        | 2.20 |
| B   | 0.045     | 0.053 | 1.15        | 1.35 |
| C   | 0.031     | 0.043 | 0.80        | 1.10 |
| D   | 0.004     | 0.012 | 0.10        | 0.30 |
| G   | 0.026 BSC |       | 0.65 BSC    |      |
| H   | ---       | 0.004 | ---         | 0.10 |
| J   | 0.004     | 0.010 | 0.10        | 0.25 |
| K   | 0.004     | 0.012 | 0.10        | 0.30 |
| N   | 0.008 REF |       | 0.20 REF    |      |
| S   | 0.079     | 0.087 | 2.00        | 2.20 |

### SOLDERING FOOTPRINT\*

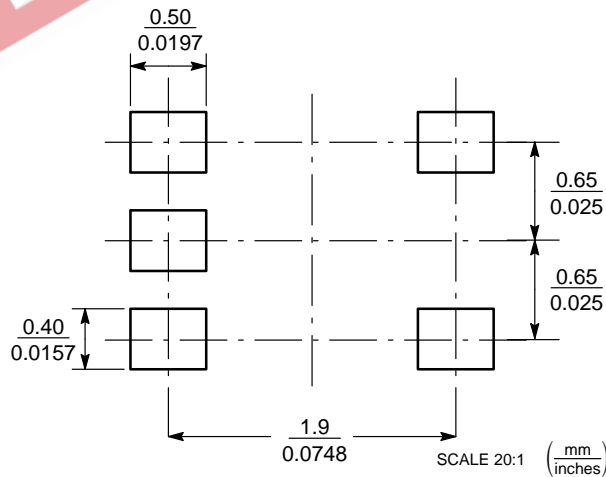

\*For additional information on our Pb-Free strategy and soldering details, please download the ON Semiconductor Soldering and Mounting Techniques Reference Manual, SOLDERRM/D.

# MC74HC1G04

## PACKAGE DIMENSIONS

SOT23-5/TSOP-5/SC59-5

DT SUFFIX  
5-LEAD PACKAGE  
CASE 483-02  
ISSUE C

NOTES:

1. DIMENSIONING AND TOLERANCING PER ANSI Y14.5M, 1982.
2. CONTROLLING DIMENSION: MILLIMETER.
3. MAXIMUM LEAD THICKNESS INCLUDES LEAD FINISH THICKNESS. MINIMUM LEAD THICKNESS IS THE MINIMUM THICKNESS OF BASE MATERIAL.
4. A AND B DIMENSIONS DO NOT INCLUDE MOLD FLASH, PROTRUSIONS, OR GATE BURRS.

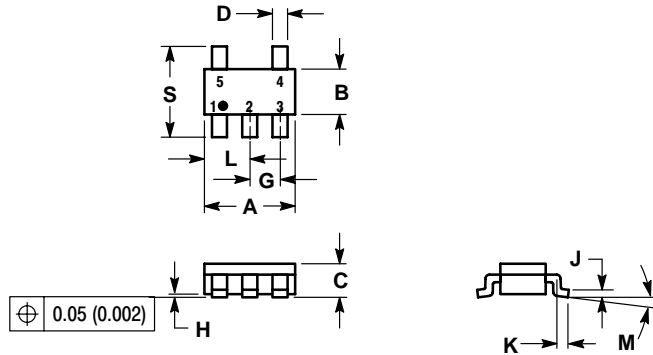

| DIM | MILLIMETERS |       | INCHES |        |
|-----|-------------|-------|--------|--------|
|     | MIN         | MAX   | MIN    | MAX    |
| A   | 2.90        | 3.10  | 0.1142 | 0.1220 |
| B   | 1.30        | 1.70  | 0.0512 | 0.0669 |
| C   | 0.90        | 1.10  | 0.0354 | 0.0433 |
| D   | 0.25        | 0.50  | 0.0098 | 0.0197 |
| G   | 0.85        | 1.05  | 0.0335 | 0.0413 |
| H   | 0.013       | 0.100 | 0.0005 | 0.0040 |
| J   | 0.10        | 0.26  | 0.0040 | 0.0102 |
| K   | 0.20        | 0.60  | 0.0079 | 0.0236 |
| L   | 1.25        | 1.55  | 0.0493 | 0.0610 |
| M   | 0           | 10    | 0      | 10     |
| S   | 2.50        | 3.00  | 0.0985 | 0.1181 |

### SOLDERING FOOTPRINT\*

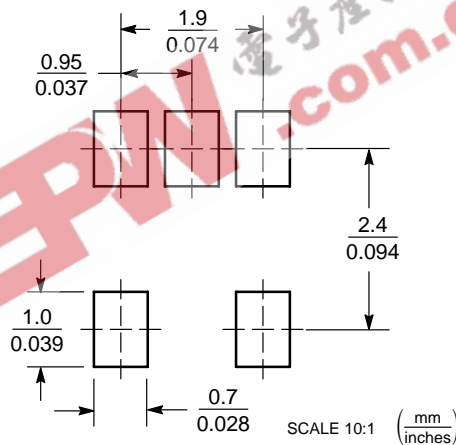

\*For additional information on our Pb-Free strategy and soldering details, please download the ON Semiconductor Soldering and Mounting Techniques Reference Manual, SOLDERRM/D.

ON Semiconductor and  are registered trademarks of Semiconductor Components Industries, LLC (SCILLC). SCILLC reserves the right to make changes without further notice to any products herein. SCILLC makes no warranty, representation or guarantee regarding the suitability of its products for any particular purpose, nor does SCILLC assume any liability arising out of the application or use of any product or circuit, and specifically disclaims any and all liability, including without limitation special, consequential or incidental damages. "Typical" parameters which may be provided in SCILLC data sheets and/or specifications can and do vary in different applications and actual performance may vary over time. All operating parameters, including "Typicals" must be validated for each customer application by customer's technical experts. SCILLC does not convey any license under its patent rights nor the rights of others. SCILLC products are not designed, intended, or authorized for use as components in systems intended for surgical implant into the body, or other applications intended to support or sustain life, or for any other application in which the failure of the SCILLC product could create a situation where personal injury or death may occur. Should Buyer purchase or use SCILLC products for any such unintended or unauthorized application, Buyer shall indemnify and hold SCILLC and its officers, employees, subsidiaries, affiliates, and distributors harmless against all claims, costs, damages, and expenses, and reasonable attorney fees arising out of, directly or indirectly, any claim of personal injury or death associated with such unintended or unauthorized use, even if such claim alleges that SCILLC was negligent regarding the design or manufacture of the part. SCILLC is an Equal Opportunity/Affirmative Action Employer. This literature is subject to all applicable copyright laws and is not for resale in any manner.

### PUBLICATION ORDERING INFORMATION

**LITERATURE FULFILLMENT:**

Literature Distribution Center for ON Semiconductor  
P.O. Box 61312, Phoenix, Arizona 85082-1312 USA  
Phone: 480-829-7710 or 800-344-3860 Toll Free USA/Canada  
Fax: 480-829-7709 or 800-344-3867 Toll Free USA/Canada  
Email: orderlit@onsemi.com

**N. American Technical Support:** 800-282-9855 Toll Free  
USA/Canada

**Japan:** ON Semiconductor, Japan Customer Focus Center  
2-9-1 Kamimeguro, Meguro-ku, Tokyo, Japan 153-0051  
Phone: 81-3-5773-3850

**ON Semiconductor Website:** <http://onsemi.com>

**Order Literature:** <http://www.onsemi.com/litorder>

For additional information, please contact your local Sales Representative.