

MC79L00 SERIES NEGATIVE-VOLTAGE REGULATORS

SLVS011D – OCTOBER 1982 – REVISED AUGUST 2003

- 3-Terminal Regulators
- Output Current Up To 100 mA
- No External Components Required
- Internal Thermal-Overload Protection
- Internal Short-Circuit Current Limiting
- Direct Replacement for Industry-Standard MC79L00 Series
- Available in 5% or 10% Selections

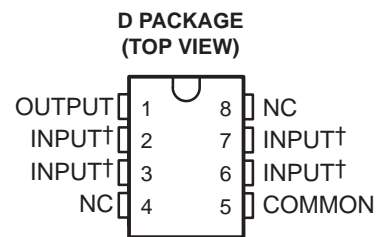

† Internally connected
NC – No internal connection

description/ordering information

This series of fixed negative-voltage integrated-circuit voltage regulators is designed for a wide range of applications. These include on-card regulation for elimination of noise and distribution problems associated with single-point regulation. In addition, they can be used to control series pass elements to make high-current voltage-regulator circuits. One of these regulators can deliver up to 100 mA of output current. The internal current-limiting and thermal-shutdown features essentially make the regulators immune to overload. When used as a replacement for a Zener-diode and resistor combination, these devices can provide an effective improvement in output impedance of two orders of magnitude, with lower bias current.

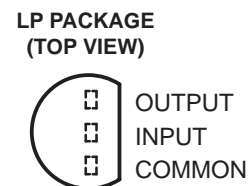

ORDERING INFORMATION

T _J	OUTPUT VOLTAGE TOLERANCE	NOMINAL OUTPUT VOLTAGE (V)	PACKAGE†		ORDERABLE PART NUMBER	TOP-SIDE MARKING
0°C to 125°C	5%	-5	SOIC (D)	Tube of 75	MC79L05ACD	79L05A
				Reel of 2500	MC79L05ACDR	
		TO-226 / TO-92 (LP)	Bulk of 1000	MC79L05ACL	79L05AC	
			Reel of 2000	MC79L05ACLPR		
		-12	SOIC (D)	Tube of 75	MC79L12ACD	79L12A
				Reel of 2500	MC79L12ACDR	
	TO-226 / TO-92 (LP)		Bulk of 1000	MC79L12ACL	79L12AC	
			Reel of 2000	MC79L12ACLPR		
	-15	TO-226 / TO-92 (LP)	Bulk of 1000	MC79L15ACL	79L15AC	
			Ammo of 2000	MC79L15ACLPM		
			Reel of 2000	MC79L15ACLPR		
	10%	-12	TO-226 / TO-92 (LP)	Bulk of 1000	MC79L12CLP	79L12C
-15		SOIC (D)	Tube of 75	MC79L15CD	79L15C	

† Package drawings, standard packing quantities, thermal data, symbolization, and PCB design guidelines are available at www.ti.com/sc/package.



Please be aware that an important notice concerning availability, standard warranty, and use in critical applications of Texas Instruments semiconductor products and disclaimers thereto appears at the end of this data sheet.

PRODUCTION DATA information is current as of publication date. Products conform to specifications per the terms of Texas Instruments standard warranty. Production processing does not necessarily include testing of all parameters.

**TEXAS
INSTRUMENTS**

POST OFFICE BOX 655303 • DALLAS, TEXAS 75265

Copyright © 2003, Texas Instruments Incorporated

MC79L00 SERIES NEGATIVE-VOLTAGE REGULATORS

SLVS011D – OCTOBER 1982 – REVISED AUGUST 2003

equivalent schematic

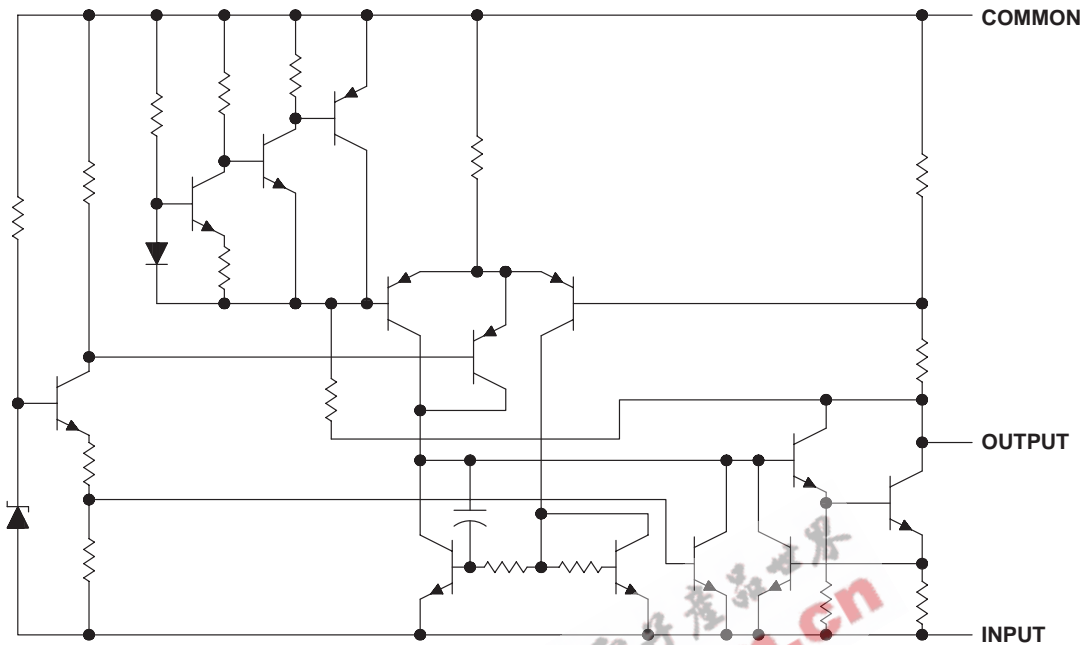

absolute maximum ratings over operating free-air temperature range (unless otherwise noted)[†]

Input voltage: MC79L05	-30 V
MC79L12, MC79L15	-35 V
Package thermal impedance, θ_{JA} (see Notes 1 and 2): D package	97°C/W
LP package	140°C/W
Operating free-air, case, or virtual junction temperature	150°C
Lead temperature 1.6 mm (1/16 inch) from case for 10 seconds	260°C
Storage temperature range, T_{stg}	-65°C to 150°C

[†] Stresses beyond those listed under "absolute maximum ratings" may cause permanent damage to the device. These are stress ratings only, and functional operation of the device at these or any other conditions beyond those indicated under "recommended operating conditions" is not implied. Exposure to absolute-maximum-rated conditions for extended periods may affect device reliability.

- NOTES: 1. Maximum power dissipation is a function of $T_J(max)$, θ_{JA} , and T_A . The maximum allowable power dissipation at any allowable ambient temperature is $P_D = (T_J(max) - T_A) / \theta_{JA}$. Operating at the absolute maximum T_J of 150°C can affect reliability.
2. The package thermal impedance is calculated in accordance with JESD 51-7.

recommended operating conditions

		MIN	MAX	UNIT	
V _I	Input voltage	MC79L05	-7	-20	V
		MC79L12	-14.5	-27	
		MC79L15	-17.5	-30	
I _O	Output current		100	mA	
T _J	Operating virtual junction temperature	0	125	°C	

MC79L00 SERIES NEGATIVE-VOLTAGE REGULATORS

SLVS011D – OCTOBER 1982 – REVISED AUGUST 2003

electrical characteristics at specified virtual junction temperature, $V_I = -10\text{ V}$, $I_O = 40\text{ mA}$ (unless otherwise noted)

PARAMETER	TEST CONDITIONS†	T_J	MC79L05C			MC79L05AC			UNIT
			MIN	TYP	MAX	MIN	TYP	MAX	
Output voltage‡		25°C	-4.6	-5	-5.4	-4.8	-5	-5.2	V
	$V_I = -7\text{ V to }-20\text{ V}$, $I_O = 1\text{ mA to }40\text{ mA}$	0°C to 125°C	-4.5		-5.5	-4.75		-5.25	
	$V_I = -10\text{ V}$, $I_O = 1\text{ mA to }70\text{ mA}$	0°C to 125°C	-4.5		-5.5	-4.75		-5.25	
Input regulation	$V_I = -7\text{ V to }-20\text{ V}$	25°C	200			150			mV
	$V_I = -8\text{ V to }-20\text{ V}$		150			100			
Ripple rejection	$V_I = -8\text{ V to }-18\text{ V}$, $f = 120\text{ Hz}$	25°C	40	49		41	49		dB
Output regulation	$I_O = 1\text{ mA to }100\text{ mA}$	25°C	60			60			mV
	$I_O = 1\text{ mA to }40\text{ mA}$		30			30			
Output noise voltage	$f = 10\text{ Hz to }100\text{ kHz}$	25°C	40			40			μV
Dropout voltage	$I_O = 40\text{ mA}$	25°C	1.7			1.7			V
Bias current		25°C	6			6			mA
		125°C	5.5			5.5			
Bias current change	$V_I = -8\text{ V to }-20\text{ V}$	0°C to 125°C	1.5			1.5			mA
	$I_O = 1\text{ mA to }40\text{ mA}$		0.2			0.1			

† All characteristics are measured with a 0.33- μF capacitor across the input and a 0.1- μF capacitor across the output. Pulse-testing techniques are used to maintain the junction temperature as close to the ambient temperature as possible. Thermal effects must be taken into account separately.

‡ This specification applies only for dc power dissipation permitted by absolute maximum ratings.

electrical characteristics at specified virtual junction temperature, $V_I = -19\text{ V}$, $I_O = 40\text{ mA}$ (unless otherwise noted)

PARAMETER	TEST CONDITIONS†	T_J	MC79L12C			MC79L12AC			UNIT
			MIN	TYP	MAX	MIN	TYP	MAX	
Output voltage‡		25°C	-11.1	-12	-12.9	-11.5	-12	-12.5	V
	$V_I = -14.5\text{ V to }-27\text{ V}$, $I_O = 1\text{ mA to }40\text{ mA}$	0°C to 125°C	-10.8		-13.2	-11.4		-12.6	
	$V_I = -19\text{ V}$, $I_O = 1\text{ mA to }70\text{ mA}$	0°C to 125°C	-10.8		-13.2	-11.4		-12.6	
Input regulation	$V_I = -14.5\text{ V to }-27\text{ V}$	25°C	250			250			mV
	$V_I = -16\text{ V to }-27\text{ V}$		200			200			
Ripple rejection	$V_I = -15\text{ V to }-25\text{ V}$, $f = 120\text{ Hz}$	25°C	36	42		37	42		dB
Output regulation	$I_O = 1\text{ mA to }100\text{ mA}$	25°C	100			100			mV
	$I_O = 1\text{ mA to }40\text{ mA}$		50			50			
Output noise voltage	$f = 10\text{ Hz to }100\text{ kHz}$	25°C	80			80			μV
Dropout voltage	$I_O = 40\text{ mA}$	25°C	1.7			1.7			V
Bias current		25°C	6.5			6.5			mA
		125°C	6			6			
Bias current change	$V_I = -16\text{ V to }-27\text{ V}$	0°C to 125°C	1.5			1.5			mA
	$I_O = 1\text{ mA to }40\text{ mA}$		0.2			0.1			

† All characteristics are measured with a 0.33- μF capacitor across the input and a 0.1- μF capacitor across the output. Pulse-testing techniques are used to maintain the junction temperature as close to the ambient temperature as possible. Thermal effects must be taken into account separately.

‡ This specification applies only for dc power dissipation permitted by absolute maximum ratings.

MC79L00 SERIES NEGATIVE-VOLTAGE REGULATORS

SLVS011D – OCTOBER 1982 – REVISED AUGUST 2003

electrical characteristics at specified virtual junction temperature, $V_I = -23\text{ V}$, $I_O = 40\text{ mA}$ (unless otherwise noted)

PARAMETER	TEST CONDITIONS†	T_J	MC79L15C			MC79L15AC			UNIT
			MIN	TYP	MAX	MIN	TYP	MAX	
Output voltage‡		25°C	-13.8	-15	-16.2	-14.4	-15	-15.6	V
	$V_I = -17.5\text{ V to }-30\text{ V}$, $I_O = 1\text{ mA to }40\text{ mA}$	0°C to 125°C	-13.5		-16.5	-14.25		-15.75	
	$V_I = -23\text{ V}$, $I_O = 1\text{ mA to }70\text{ mA}$	0°C to 125°C	-13.5		-16.5	-14.25		-15.75	
Input regulation	$V_I = -17.5\text{ V to }-30\text{ V}$	25°C				300			mV
	$V_I = -17.5\text{ V to }-30\text{ V}$					250			
Ripple rejection	$V_I = -18.5\text{ V to }-28.5\text{ V}$, $f = 120\text{ Hz}$	25°C	33	39		34	39		dB
Output regulation	$I_O = 1\text{ mA to }100\text{ mA}$	25°C				150			mV
	$I_O = 1\text{ mA to }40\text{ mA}$					75			
Output noise voltage	$f = 10\text{ Hz to }100\text{ kHz}$	25°C	90			90			μV
Dropout voltage	$I_O = 40\text{ mA}$	25°C	1.7			1.7			V
Bias current		25°C				6.5			mA
		125°C				6			
Bias current change	$V_I = -20\text{ V to }-30\text{ V}$	0°C to 125°C				1.5			mA
	$I_O = 1\text{ mA to }40\text{ mA}$					0.2			

† All characteristics are measured with a 0.33- μF capacitor across the input and a 0.1- μF capacitor across the output. Pulse-testing techniques are used to maintain the junction temperature as close to the ambient temperature as possible. Thermal effects must be taken into account separately.

‡ This specification applies only for dc power dissipation permitted by absolute maximum ratings.

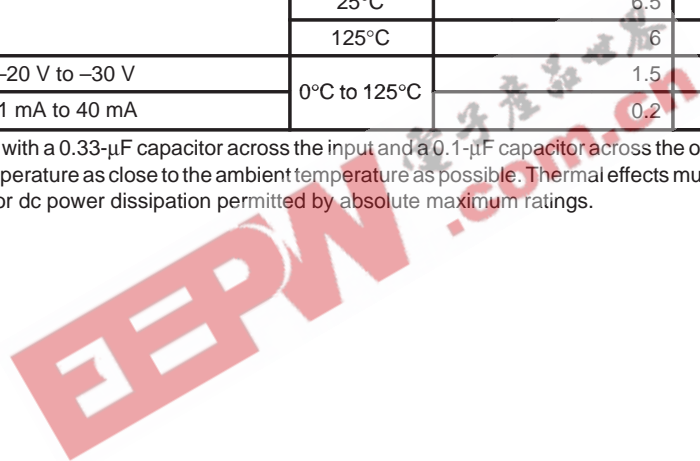

PACKAGING INFORMATION

Orderable Device	Status ⁽¹⁾	Package Type	Package Drawing	Pins	Package Qty	Eco Plan ⁽²⁾	Lead/Ball Finish	MSL Peak Temp ⁽³⁾
MC79L05ACD	ACTIVE	SOIC	D	8	75	Green (RoHS & no Sb/Br)	CU NIPDAU	Level-1-260C-UNLIM
MC79L05ACDE4	ACTIVE	SOIC	D	8	75	Green (RoHS & no Sb/Br)	CU NIPDAU	Level-1-260C-UNLIM
MC79L05ACDG4	ACTIVE	SOIC	D	8	75	Green (RoHS & no Sb/Br)	CU NIPDAU	Level-1-260C-UNLIM
MC79L05ACDR	ACTIVE	SOIC	D	8	2500	Green (RoHS & no Sb/Br)	CU NIPDAU	Level-1-260C-UNLIM
MC79L05ACDRE4	ACTIVE	SOIC	D	8	2500	Green (RoHS & no Sb/Br)	CU NIPDAU	Level-1-260C-UNLIM
MC79L05ACDRG4	ACTIVE	SOIC	D	8	2500	Green (RoHS & no Sb/Br)	CU NIPDAU	Level-1-260C-UNLIM
MC79L05ACLP	ACTIVE	TO-92	LP	3	1000	TBD	CU SNPB	Level-NC-NC-NC
MC79L05ACLPR	ACTIVE	TO-92	LP	3	2000	TBD	CU SNPB	Level-NC-NC-NC
MC79L05AILP	OBSOLETE	TO-92	LP	3		TBD	Call TI	Call TI
MC79L05CD	OBSOLETE	SOIC	D	8		TBD	Call TI	Call TI
MC79L05CDR	OBSOLETE	SOIC	D	8		TBD	Call TI	Call TI
MC79L05CLP	OBSOLETE	TO-92	LP	3		TBD	Call TI	Call TI
MC79L12ACD	ACTIVE	SOIC	D	8	75	Green (RoHS & no Sb/Br)	CU NIPDAU	Level-1-260C-UNLIM
MC79L12ACDE4	ACTIVE	SOIC	D	8	75	Green (RoHS & no Sb/Br)	CU NIPDAU	Level-1-260C-UNLIM
MC79L12ACDR	ACTIVE	SOIC	D	8	2500	Green (RoHS & no Sb/Br)	CU NIPDAU	Level-1-260C-UNLIM
MC79L12ACDRE4	ACTIVE	SOIC	D	8	2500	Green (RoHS & no Sb/Br)	CU NIPDAU	Level-1-260C-UNLIM
MC79L12ACLP	ACTIVE	TO-92	LP	3	1000	TBD	CU SNPB	Level-NC-NC-NC
MC79L12ACLPR	ACTIVE	TO-92	LP	3	2000	TBD	CU SNPB	Level-NC-NC-NC
MC79L12CD	OBSOLETE	SOIC	D	8		TBD	Call TI	Call TI
MC79L12CLP	ACTIVE	TO-92	LP	3	1000	TBD	CU SNPB	Level-NC-NC-NC
MC79L15ACD	OBSOLETE	SOIC	D	8		TBD	Call TI	Call TI
MC79L15ACLP	ACTIVE	TO-92	LP	3	1000	TBD	CU SNPB	Level-NC-NC-NC
MC79L15ACLPM	ACTIVE	TO-92	LP	3	2000	TBD	CU SNPB	Level-NC-NC-NC
MC79L15ACLPR	ACTIVE	TO-92	LP	3	2000	TBD	CU SNPB	Level-NC-NC-NC
MC79L15CD	ACTIVE	SOIC	D	8	75	Green (RoHS & no Sb/Br)	CU NIPDAU	Level-1-260C-UNLIM
MC79L15CDE4	ACTIVE	SOIC	D	8	75	Green (RoHS & no Sb/Br)	CU NIPDAU	Level-1-260C-UNLIM
MC79L15CLP	OBSOLETE	TO-92	LP	3		TBD	Call TI	Call TI

⁽¹⁾ The marketing status values are defined as follows:

ACTIVE: Product device recommended for new designs.

LIFEBUY: TI has announced that the device will be discontinued, and a lifetime-buy period is in effect.

NRND: Not recommended for new designs. Device is in production to support existing customers, but TI does not recommend using this part in a new design.

PREVIEW: Device has been announced but is not in production. Samples may or may not be available.

OBSOLETE: TI has discontinued the production of the device.

(2) Eco Plan - The planned eco-friendly classification: Pb-Free (RoHS) or Green (RoHS & no Sb/Br) - please check <http://www.ti.com/productcontent> for the latest availability information and additional product content details.

TBD: The Pb-Free/Green conversion plan has not been defined.

Pb-Free (RoHS): TI's terms "Lead-Free" or "Pb-Free" mean semiconductor products that are compatible with the current RoHS requirements for all 6 substances, including the requirement that lead not exceed 0.1% by weight in homogeneous materials. Where designed to be soldered at high temperatures, TI Pb-Free products are suitable for use in specified lead-free processes.

Green (RoHS & no Sb/Br): TI defines "Green" to mean Pb-Free (RoHS compatible), and free of Bromine (Br) and Antimony (Sb) based flame retardants (Br or Sb do not exceed 0.1% by weight in homogeneous material)

(3) MSL, Peak Temp. -- The Moisture Sensitivity Level rating according to the JEDEC industry standard classifications, and peak solder temperature.

Important Information and Disclaimer:The information provided on this page represents TI's knowledge and belief as of the date that it is provided. TI bases its knowledge and belief on information provided by third parties, and makes no representation or warranty as to the accuracy of such information. Efforts are underway to better integrate information from third parties. TI has taken and continues to take reasonable steps to provide representative and accurate information but may not have conducted destructive testing or chemical analysis on incoming materials and chemicals. TI and TI suppliers consider certain information to be proprietary, and thus CAS numbers and other limited information may not be available for release.

In no event shall TI's liability arising out of such information exceed the total purchase price of the TI part(s) at issue in this document sold by TI to Customer on an annual basis.

EEPW 电子产品世界
.com.cn

MECHANICAL DATA

D (R-PDSO-G8)

PLASTIC SMALL-OUTLINE PACKAGE

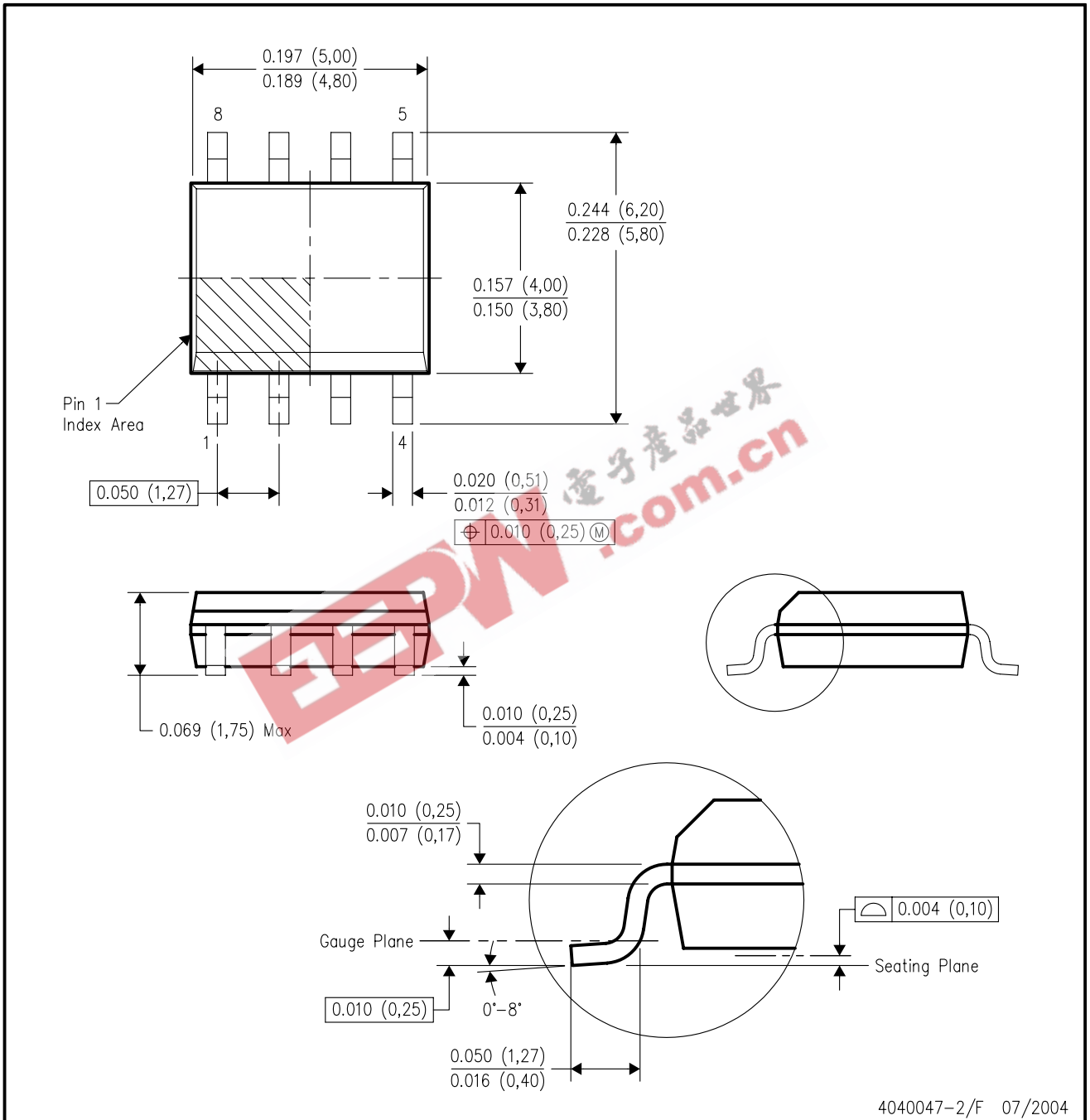

- NOTES:
- All linear dimensions are in inches (millimeters).
 - This drawing is subject to change without notice.
 - Body dimensions do not include mold flash or protrusion not to exceed 0.006 (0,15).
 - Falls within JEDEC MS-012 variation AA.

MECHANICAL DATA

MSOT002A – OCTOBER 1994 – REVISED NOVEMBER 2001

LP (O-PBCY-W3)

PLASTIC CYLINDRICAL PACKAGE

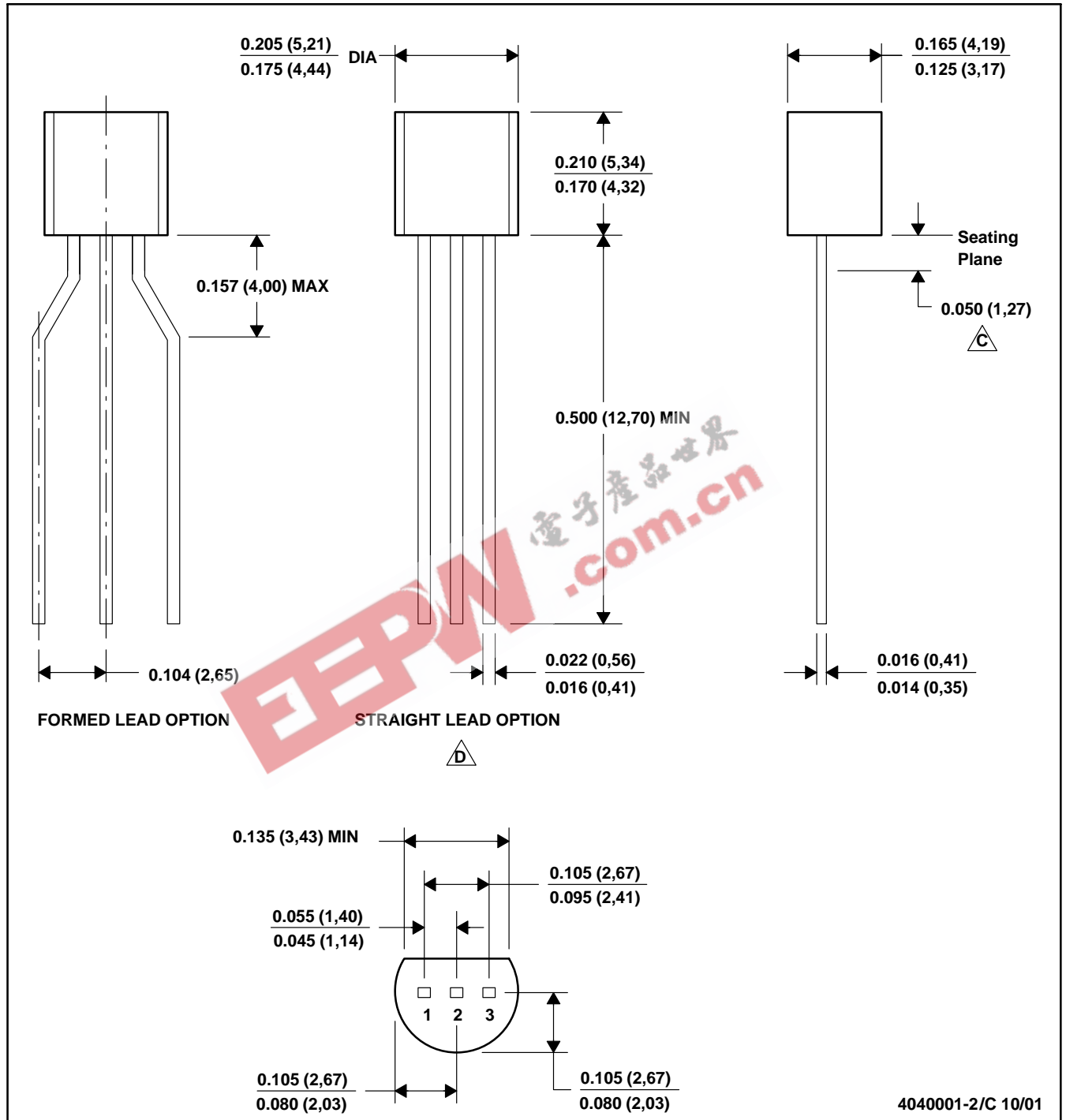

4040001-2/C 10/01

- NOTES:
- A. All linear dimensions are in inches (millimeters).
 - B. This drawing is subject to change without notice.
 - C** Lead dimensions are not controlled within this area
 - D** Falls within JEDEC TO -226 Variation AA (TO-226 replaces TO-92)
 - E. Shipping Method:
 - Straight lead option available in bulk pack only.
 - Formed lead option available in tape & reel or ammo pack.

MECHANICAL DATA

MSOT002A – OCTOBER 1994 – REVISED NOVEMBER 2001

LP (O-PBCY-W3)

PLASTIC CYLINDRICAL PACKAGE

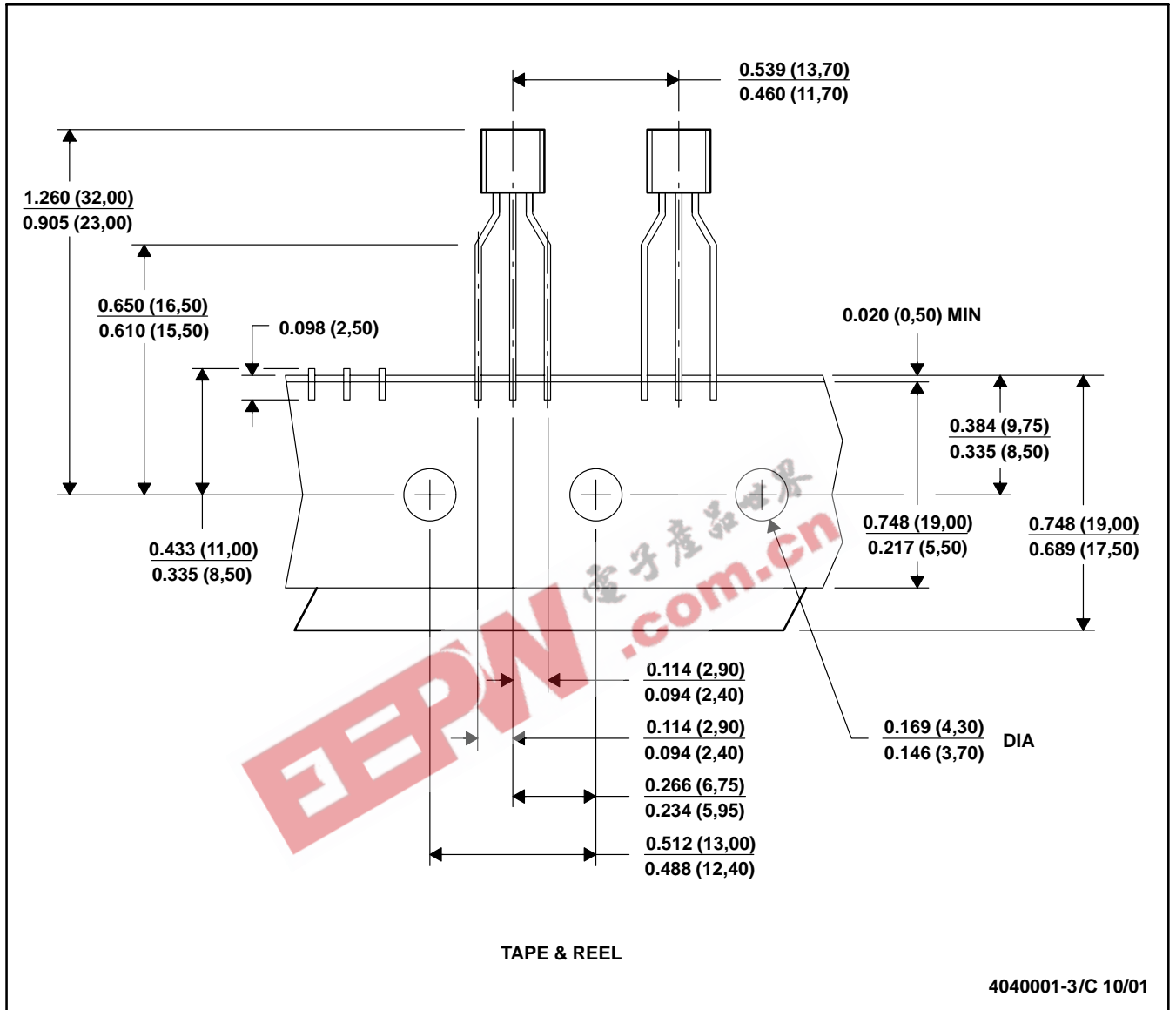

- NOTES:
- All linear dimensions are in inches (millimeters).
 - This drawing is subject to change without notice.
 - Tape and Reel information for the Format Lead Option package.

IMPORTANT NOTICE

Texas Instruments Incorporated and its subsidiaries (TI) reserve the right to make corrections, modifications, enhancements, improvements, and other changes to its products and services at any time and to discontinue any product or service without notice. Customers should obtain the latest relevant information before placing orders and should verify that such information is current and complete. All products are sold subject to TI's terms and conditions of sale supplied at the time of order acknowledgment.

TI warrants performance of its hardware products to the specifications applicable at the time of sale in accordance with TI's standard warranty. Testing and other quality control techniques are used to the extent TI deems necessary to support this warranty. Except where mandated by government requirements, testing of all parameters of each product is not necessarily performed.

TI assumes no liability for applications assistance or customer product design. Customers are responsible for their products and applications using TI components. To minimize the risks associated with customer products and applications, customers should provide adequate design and operating safeguards.

TI does not warrant or represent that any license, either express or implied, is granted under any TI patent right, copyright, mask work right, or other TI intellectual property right relating to any combination, machine, or process in which TI products or services are used. Information published by TI regarding third-party products or services does not constitute a license from TI to use such products or services or a warranty or endorsement thereof. Use of such information may require a license from a third party under the patents or other intellectual property of the third party, or a license from TI under the patents or other intellectual property of TI.

Reproduction of information in TI data books or data sheets is permissible only if reproduction is without alteration and is accompanied by all associated warranties, conditions, limitations, and notices. Reproduction of this information with alteration is an unfair and deceptive business practice. TI is not responsible or liable for such altered documentation.

Resale of TI products or services with statements different from or beyond the parameters stated by TI for that product or service voids all express and any implied warranties for the associated TI product or service and is an unfair and deceptive business practice. TI is not responsible or liable for any such statements.

Following are URLs where you can obtain information on other Texas Instruments products and application solutions:

Products		Applications	
Amplifiers	amplifier.ti.com	Audio	www.ti.com/audio
Data Converters	dataconverter.ti.com	Automotive	www.ti.com/automotive
DSP	dsp.ti.com	Broadband	www.ti.com/broadband
Interface	interface.ti.com	Digital Control	www.ti.com/digitalcontrol
Logic	logic.ti.com	Military	www.ti.com/military
Power Mgmt	power.ti.com	Optical Networking	www.ti.com/opticalnetwork
Microcontrollers	microcontroller.ti.com	Security	www.ti.com/security
		Telephony	www.ti.com/telephony
		Video & Imaging	www.ti.com/video
		Wireless	www.ti.com/wireless

Mailing Address: Texas Instruments
Post Office Box 655303 Dallas, Texas 75265