

Freescale Semiconductor, Inc.



MOTOROLA
intelligence everywhere™

digital dna™

MC68HC05J1A
MC68HCL05J1A
MC68HSC05J1A

Technical Data

M68HC05
Microcontrollers

MC68HC05J1A/D
Rev. 3, 4/2002

WWW.MOTOROLA.COM/SEMICONDUCTORS

**For More Information On This Product,
Go to: www.freescale.com**

Freescale Semiconductor, Inc.

Freescale Semiconductor, Inc.

Freescale Semiconductor, Inc.

EEPW 电子产品世界
.com.cn

**For More Information On This Product,
Go to: www.freescale.com**

Freescale Semiconductor, Inc.

MC68HC05J1A

MC68HCL05J1A

MC68HSC05J1A

Technical Data

To provide the most up-to-date information, the revision of our documents on the World Wide Web will be the most current. Your printed copy may be an earlier revision. To verify you have the latest information available, refer to:

<http://www.motorola.com/semiconductors/>

The following revision history table summarizes changes contained in this document. For your convenience, the page number designators have been linked to the appropriate location.

Freescale Semiconductor, Inc.

Technical Data

Revision History

Date	Revision Level	Description	Page Number(s)
July, 2001	2.0	10.5 Thermal Characteristics — In table under Thermal resistance, device numbers corrected	97
		Section 12. Ordering Information — Added Table 12-1. MC Order Numbers for clarity	111
April, 2002	3.0	Update World Wide Web address	112

Freescale Semiconductor, Inc.

Technical Data — MC68HC05J1A

List of Sections

Section 1. General Description	17
Section 2. Memory	27
Section 3. Central Processor Unit (CPU)	33
Section 4. Interrupts	41
Section 5. Resets	49
Section 6. Low-Power Modes	55
Section 7. Parallel Input/Output (I/O)	61
Section 8. Multifunction Timer	71
Section 9. Instruction Set	77
Section 10. Electrical Specifications	95
Section 11. Mechanical Specifications	109
Section 12. Ordering Information	111
Appendix A. MC68HCL05J1A	117
Appendix B. MC68HSC05J1A	123



Table of Contents

Section 1. General Description

1.1	Contents	17
1.2	Introduction	18
1.3	Features	18
1.4	Mask Options	19
1.5	MCU Structure	20
1.6	Pin Assignments	21
1.6.1	V _{DD} and V _{SS}	21
1.6.2	OSC1 and OSC2	22
1.6.2.1	Crystal	22
1.6.2.2	Ceramic Resonator	24
1.6.2.3	RC Oscillator	25
1.6.2.4	External Clock	25
1.6.3	$\overline{\text{RESET}}$	26
1.6.4	$\overline{\text{IRQ}}$	26
1.6.5	PA7–PA0	26
1.6.6	PB5–PB0	26

Section 2. Memory

2.1	Contents	27
2.2	Introduction	27
2.3	Memory Map	27
2.4	Input/Output (I/O) Section	28
2.5	Random-Access Memory (RAM)	28
2.6	Read-Only Memory (ROM)	28

Section 3. Central Processor Unit (CPU)

3.1 Contents 33

3.2 Introduction 33

3.3 CPU Registers 34

3.3.1 Accumulator 35

3.3.2 Index Register 35

3.3.3 Stack Pointer 36

3.3.4 Program Counter 37

3.3.5 Condition Code Register 38

3.4 Arithmetic/Logic Unit (ALU) 39

Section 4. Interrupts

4.1 Contents 41

4.2 Introduction 41

4.3 Interrupt Sources 41

4.3.1 Software Interrupt 42

4.3.2 External Interrupts 42

4.3.2.1 $\overline{\text{IRQ}}$ Pin 42

4.3.2.2 PA3–PA0 Pins 44

4.3.2.3 IRQ Status and Control Register 45

4.3.3 Timer Interrupts 46

4.3.3.1 Timer Overflow Interrupt 46

4.3.3.2 Real-Time Interrupt 46

4.4 Interrupt Processing 46

Section 5. Resets

5.1 Contents 49

5.2 Introduction 49

5.3 Reset Types 50

5.3.1 Power-On Reset 50

5.3.2 External Reset 51

5.3.3 Computer Operating Properly (COP) Reset 51

5.3.4 Illegal Address Reset 52

5.4 Reset States 52
5.4.1 CPU 52
5.4.2 I/O Port Registers 52
5.4.3 Multifunction Timer 53
5.4.4 COP Watchdog 53

Section 6. Low-Power Modes

6.1 Contents 55
6.2 Introduction 55
6.3 Stop Mode 55
6.4 Wait Mode 56
6.5 Halt Mode 57
6.6 Data-Retention Mode 59

Section 7. Parallel Input/Output (I/O)

7.1 Contents 61
7.2 Introduction 61
7.3 I/O Port Function 61
7.4 Port A 62
7.4.1 Port A Data Register 62
7.4.2 Data Direction Register A 63
7.4.3 Pulldown Register A 64
7.4.4 Port A External Interrupts 65
7.5 Port B 67
7.5.1 Port B Data Register 67
7.5.2 Data Direction Register B 68
7.5.3 Pulldown Register B 69

Section 8. Multifunction Timer

8.1 Contents 71

8.2 Introduction 71

8.3 Timer Status and Control Register 73

8.4 COP Watchdog 76

Section 9. Instruction Set

9.1 Contents 77

9.2 Introduction 78

9.3 Addressing Modes 78

9.3.1 Inherent 79

9.3.2 Immediate 79

9.3.3 Direct 79

9.3.4 Extended 79

9.3.5 Indexed, No Offset 80

9.3.6 Indexed, 8-Bit Offset 80

9.3.7 Indexed, 16-Bit Offset 80

9.3.8 Relative 81

9.4 Instruction Types 81

9.4.1 Register/Memory Instructions 82

9.4.2 Read-Modify-Write Instructions 83

9.4.3 Jump/Branch Instructions 84

9.4.4 Bit Manipulation Instructions 86

9.4.5 Control Instructions 87

9.5 Instruction Set Summary 88

9.6 Opcode Map 93

Section 10. Electrical Specifications

10.1 Contents 95

10.2 Introduction 95

10.3 Maximum Ratings 96

10.4 Operating Temperature Range 97

10.5 Thermal Characteristics 97

10.6 Power Considerations. 98

10.7 5.0-Volt DC Electrical Characteristics. 99

10.8 3.3-Volt DC Electrical Characteristics. 100

10.9 5.0-Volt Control Timing. 105

10.10 3.3-Volt Control Timing. 106

Section 11. Mechanical Specifications

11.1 Contents 109

11.2 Introduction. 109

11.3 20-Pin Plastic Dual In-Line Package (PDIP). 110

11.4 20-Pin Small Outline Integrated Circuit Package (SOIC) 110

Section 12. Ordering Information

12.1 Contents 111

12.2 Introduction. 111

12.3 MC Order Numbers 111

12.4 MCU Ordering Forms 112

12.5 Application Program Media. 112

12.6 Diskettes. 113

12.7 EPROMs. 114

12.8 ROM Program Verification 114

12.9 ROM Verification Units (RVUs). 115

Appendix A. MC68HCL05J1A

A.1 Contents117
A.2 Introduction.....117
A.3 DC Electrical Characteristics118
A.4 MC Ordering Information121

Appendix B. MC68HSC05J1A

B.1 Contents123
B.2 Introduction.....123
B.3 DC Electrical Characteristics124
B.4 Control Timing125
B.5 MC Ordering Information126



List of Figures

Figure	Title	Page
1-1	MC68HC05J1A Block Diagram	20
1-2	Pin Assignments	21
1-3	Bypassing Layout Recommendation	22
1-4	Crystal Connections with Feedback Resistor Mask Option	23
1-5	Crystal Connections without Feedback Resistor Mask Option	23
1-6	Ceramic Resonator Connections with Feedback Resistor Mask Option	24
1-7	Ceramic Resonator Connections without Feedback Resistor Mask Option	24
1-8	RC Oscillator Connections	25
1-9	External Clock Connections	25
2-1	Memory Map	29
2-2	I/O Register Summary	30
3-1	Programming Model	34
3-2	Accumulator (A)	35
3-3	Index Register (X)	35
3-4	Stack Pointer (SP)	36
3-5	Program Counter (PC)	37
3-6	Condition Code Register (CCR)	38
4-1	External Interrupt Logic	43
4-2	IRQ Status and Control Register (ISCR)	45
4-3	Stacking Order	47

List of Figures

Figure	Title	Page
4-4	Interrupt Flowchart	48
5-1	Reset Sources	50
5-2	COP Register (COPR)	51
6-1	Stop/Wait/Halt Flowchart	58
7-1	Port A Data Register (PORTA)	62
7-2	Data Direction Register A (DDRA)	63
7-3	Pulldown Register A (PDRA)	64
7-4	Port A I/O Circuit	65
7-5	Port B Data Register (PORTB)	67
7-6	Data Direction Register B (DDRB)	68
7-7	Pulldown Register B (PDRB)	69
7-8	Port B I/O Circuit	70
8-1	Multifunction Timer Block Diagram	72
8-2	Timer Status and Control Register (TSCR)	73
8-3	Timer Counter Register (TCNTR)	75
8-4	COP Register (COPR)	76
10-1	Typical V_{OH}/I_{OH} ($V_{DD} = 5.0\text{ V}$)	101
10-2	Typical V_{OH}/I_{OH} ($V_{DD} = 3.3\text{ V}$)	101
10-3	Typical V_{OL}/I_{OL} ($V_{DD} = 5.0\text{ V}$)	102
10-4	Typical V_{OL}/I_{OL} ($V_{DD} = 3.3\text{ V}$)	102
10-5	Typical Operating I_{DD} (25°C)	103
10-6	Typical Wait Mode I_{DD} (25°C)	103
10-7	Typical Internal Operating Frequency for Various V_{DD} at 25°C — RC Option Only	104
10-8	External Interrupt Timing	107
10-9	Stop Mode Recovery Timing	107
10-10	Power-On Reset Timing	108
10-11	External Reset Timing	108
A-1	Maximum Run Mode I_{DD} versus Frequency	120
A-2	Maximum Wait Mode I_{DD} versus Frequency	121

Freescale Semiconductor, Inc.

Technical Data — MC68HC05J1A

List of Tables

Table	Title	Page
4-1	Reset/Interrupt Vector Addresses	47
7-1	Port A Pin Functions	66
7-2	Port B Pin Functions	70
8-1	Real-Time Interrupt Rate Selection	74
9-1	Register/Memory Instructions	82
9-2	Read-Modify-Write Instructions	83
9-3	Jump and Branch Instructions	85
9-4	Bit Manipulation Instructions	86
9-5	Control Instructions	87
9-6	Instruction Set Summary	88
9-7	Opcode Map	94
12-1	MC Order Numbers	111
A-1	Low-Power Output Voltage ($V_{DD} = 1.8\text{--}2.4\text{ Vdc}$)	118
A-2	Low-Power Output Voltage ($V_{DD} = 2.5\text{--}3.6\text{ Vdc}$)	118
A-3	Low-Power Supply Current	119
A-4	Low-Power Pulldown Current	120
A-5	MC Order Numbers	121
B-1	High-Speed Supply Current	124
B-2	High-Speed Control Timing ($V_{DD} = 5.0\text{ V} \pm 10\%$)	125
B-3	High-Speed Control Timing ($V_{DD} = 3.3\text{ V} \pm 10\%$)	125
B-4	MC Order Numbers	126



Section 1. General Description

1.1 Contents

1.2	Introduction	18
1.3	Features	18
1.4	Mask Options	19
1.5	MCU Structure	20
1.6	Pin Assignments	21
1.6.1	V_{DD} and V_{SS}	21
1.6.2	OSC1 and OSC2	22
1.6.2.1	Crystal	22
1.6.2.2	Ceramic Resonator	24
1.6.2.3	RC Oscillator	25
1.6.2.4	External Clock	25
1.6.3	$\overline{\text{RESET}}$	26
1.6.4	$\overline{\text{IRQ}}$	26
1.6.5	PA7–PA0	26
1.6.6	PB5–PB0	26

1.2 Introduction

The MC68HC05J1A is a member of the low-cost, high-performance M68HC05 Family of 8-bit microcontroller units (MCU). The M68HC05 Family is based on the customer-specified integrated circuit (CSIC) design strategy. All MCUs in the family use the popular M68HC05 central processor unit (CPU) and are available with a variety of subsystems, memory sizes and types, and package types.

On-chip memory of the MC68HC05J1A includes:

- 1240 bytes of user read-only memory (ROM)
- 64 bytes of user random-access memory (RAM)

Information on the MC68HCL05J1A, a low-power version of the MC68HC05J1A, is introduced in [Appendix A. MC68HCL05J1A](#).

Information on the MC68HSC05J1A, a high-speed version of the MC68HC05J1A, is introduced in [Appendix B. MC68HSC05J1A](#).

1.3 Features

Features of the MCU include:

- Popular M68HC05 CPU
- Memory-mapped input/output (I/O) registers
- 1240 bytes of user ROM including eight user vector locations
- 64 bytes of user RAM
- 14 bidirectional I/O pins with these features:
 - Software programmable pulldown devices
 - Four I/O pins with 8-mA current sinking capability
 - Four I/O pins with maskable external interrupt capability
- Hardware mask and flag for external interrupts
- Fully static operation with no minimum clock speed
- On-chip oscillator with connections for a crystal or ceramic resonator or for a resistor-capacitor (RC) network

- 15-bit multifunction timer
- Computer operating properly (COP) watchdog
- Power-saving stop (or halt), wait, and data-retention modes
- Illegal address reset
- Internal steering diode between $\overline{\text{RESET}}$ and V_{DD} pins
- 8×8 unsigned multiply instruction
- 20-pin plastic dual in-line package (PDIP)
- 20-pin small outline integrated circuit package (SOIC)

1.4 Mask Options

Available MC68HC05J1A mask options are:

- On-chip oscillator connections: crystal/ceramic resonator connections or resistor-capacitor (RC) network connections
- Crystal/ceramic resonator feedback resistor: connected or not connected (available only with crystal/ceramic oscillator mask option)
- STOP instruction: enabled or disabled (converted to WAIT instruction)
- External interrupt pins: edge-triggered or edge- and level-triggered
- Port A and port B pulldown resistors: connected or not connected
- COP watchdog timer: enabled or disabled
- Port A external interrupt capability: enabled or disabled

General Description

1.5 MCU Structure

Figure 1-1 shows the structure of the MC68HC05J1A MCU.

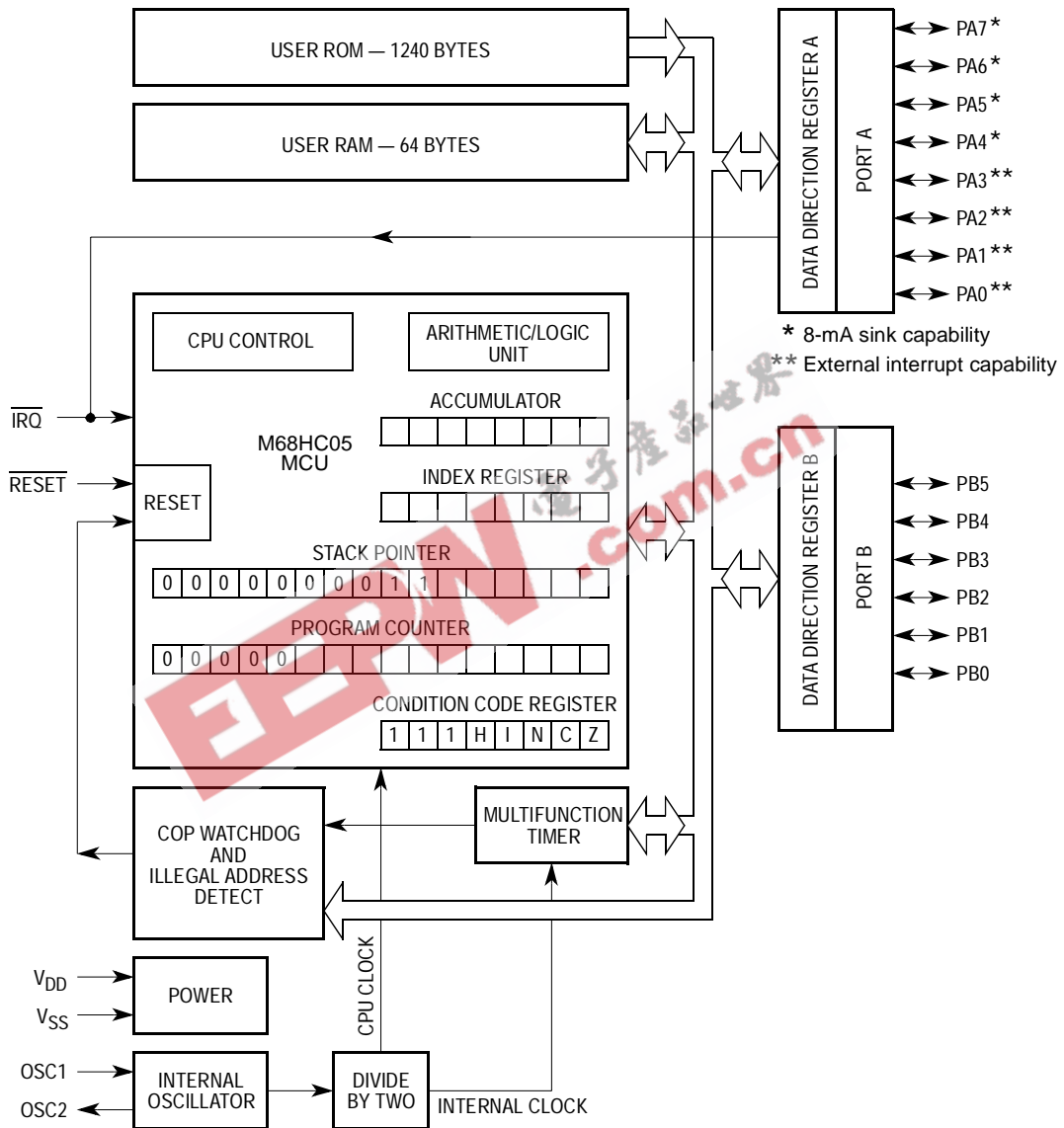

Figure 1-1. MC68HC05J1A Block Diagram

1.6 Pin Assignments

Figure 1-2 shows the MC68HC05J1A pin assignments.

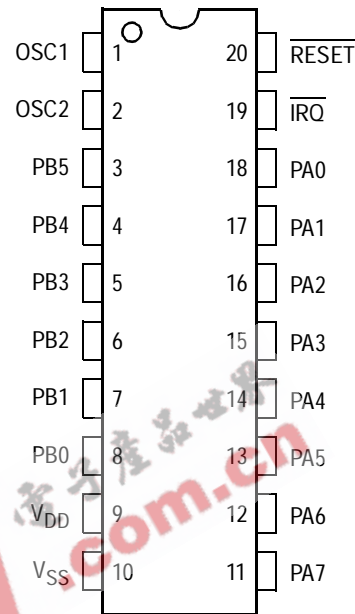

Figure 1-2. Pin Assignments

1.6.1 V_{DD} and V_{SS}

V_{DD} and V_{SS} are the power supply and ground pins. The MCU operates from a single 5-V power supply.

Very fast signal transitions occur on the MCU pins, placing high short-duration current demands on the power supply. To prevent noise problems, take special care to provide good power supply bypassing at the MCU. Place bypass capacitors as close to the MCU as possible, as Figure 1-3 shows. C2 is an optional bulk current bypass capacitor for use in applications that require the port pins to source high current levels.

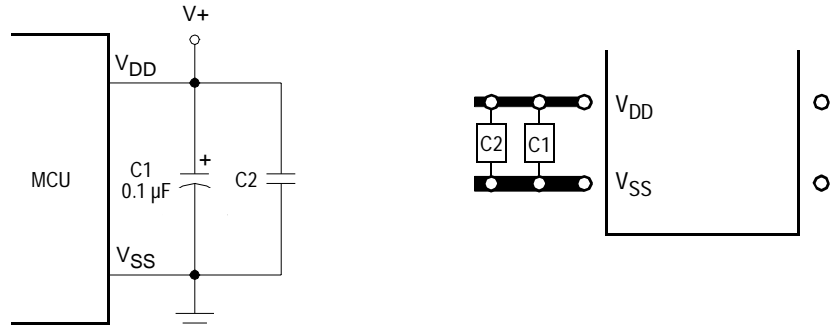

Figure 1-3. Bypassing Layout Recommendation

1.6.2 OSC1 and OSC2

The OSC1 and OSC2 pins are the control connections for the on-chip oscillator. Depending on the mask option selected, the oscillator can be driven by any one of these:

- Crystal
- Ceramic resonator
- Resistor-capacitor (RC) network
- External clock signal

The frequency of the internal oscillator is f_{OSC} . The MCU divides the internal oscillator output by two to produce the internal clock with a frequency of f_{OP} .

An internal feedback resistor between the OSC1 and OSC2 pins is available as a mask option. The feedback resistor mask option is available only when the crystal/ceramic resonator mask option is also selected.

1.6.2.1 Crystal

With the crystal/ceramic resonator mask option, a crystal connected to the OSC1 and OSC2 pins can drive the on-chip oscillator. **Figure 1-4** and **Figure 1-5** show a typical crystal oscillator circuit for an AT-cut, parallel resonant crystal. Follow the crystal supplier's recommendations, as the crystal parameters determine the external component values

required to provide reliable startup and maximum stability. The load capacitance values used in the oscillator circuit design should include all stray layout capacitances. To minimize output distortion, mount the crystal and capacitors as close as possible to the pins.

NOTE: Use an AT-cut crystal and not an AT-strip crystal. The MCU may overdrive an AT-strip crystal.

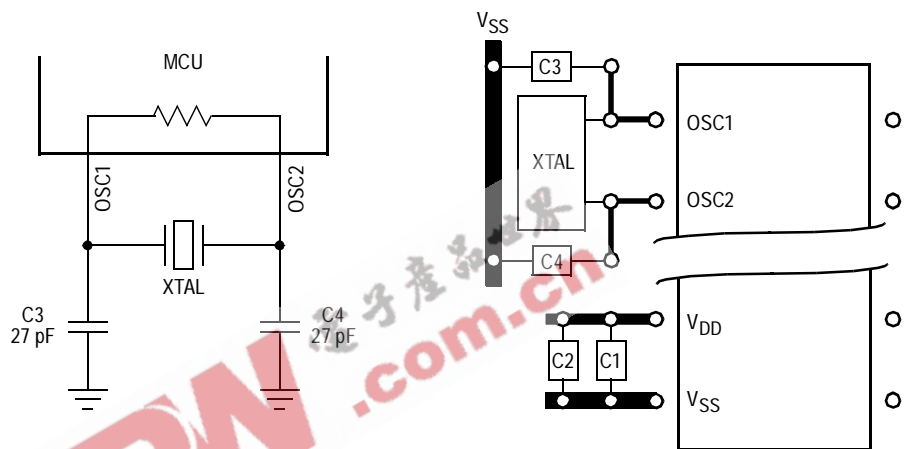

Figure 1-4. Crystal Connections with Feedback Resistor Mask Option

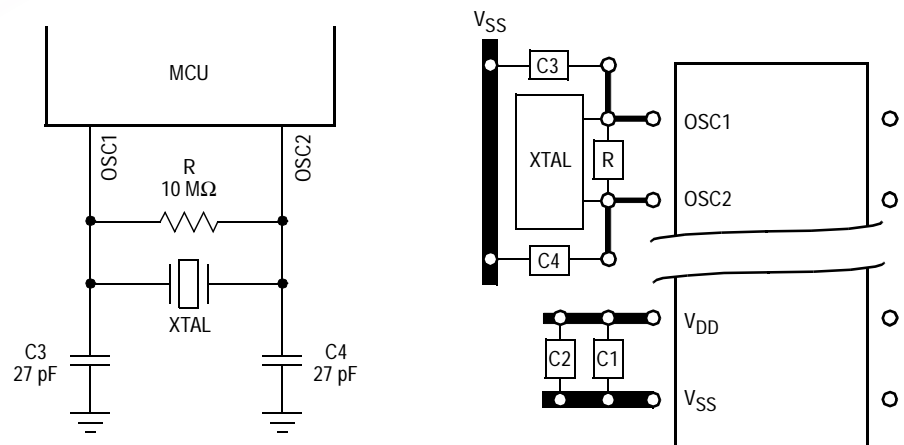

Figure 1-5. Crystal Connections without Feedback Resistor Mask Option

General Description

1.6.2.2 Ceramic Resonator

To reduce cost, use a ceramic resonator in place of the crystal. Use the circuit in **Figure 1-6** or **Figure 1-7** for a ceramic resonator and follow the resonator manufacturer's recommendations. The load capacitance values used in the oscillator circuit design should include all stray layout capacitances. To minimize output distortion, mount the resonator as close as possible to the pins.

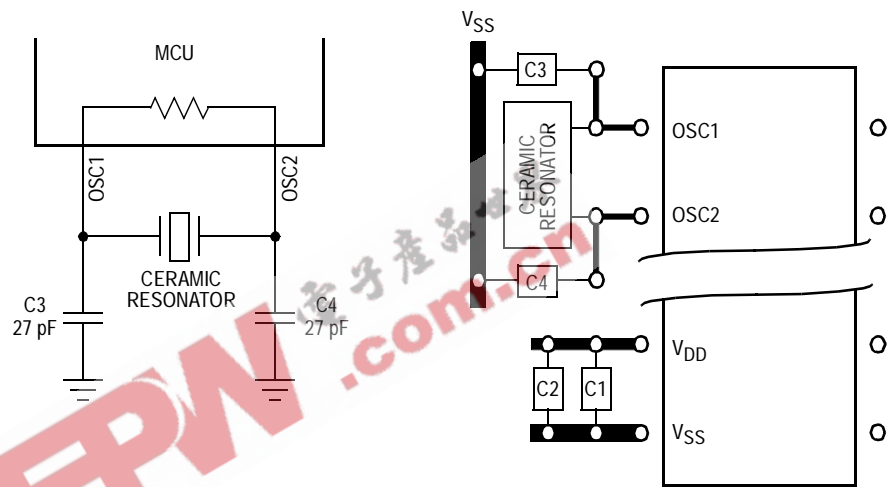

Figure 1-6. Ceramic Resonator Connections with Feedback Resistor Mask Option

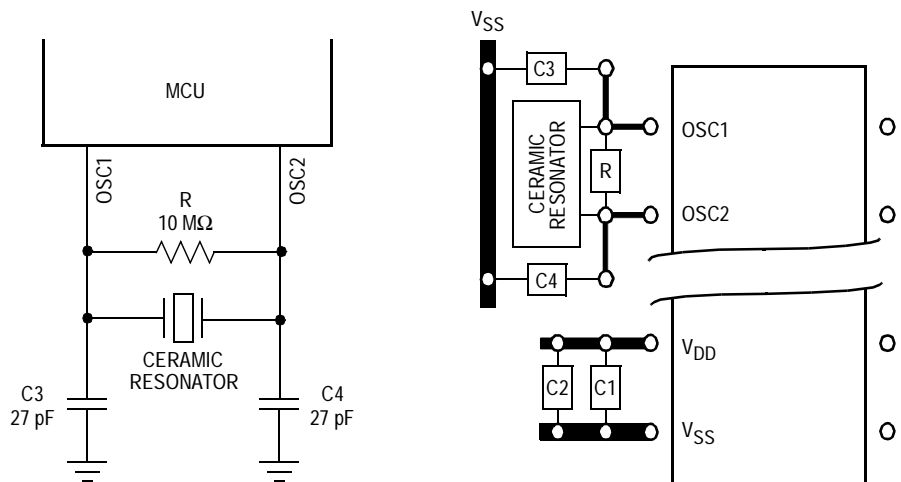

Figure 1-7. Ceramic Resonator Connections without Feedback Resistor Mask Option

1.6.2.3 RC Oscillator

For maximum cost reduction, the RC oscillator mask option allows the configuration shown in **Figure 1-8** to drive the on-chip oscillator. The OSC2 signal is a square wave, and the signal on OSC1 is a triangular wave. The optimum frequency for the RC oscillator configuration is 2 MHz. Mount the RC components as close as possible to the pins for startup stabilization and to minimize output distortion.

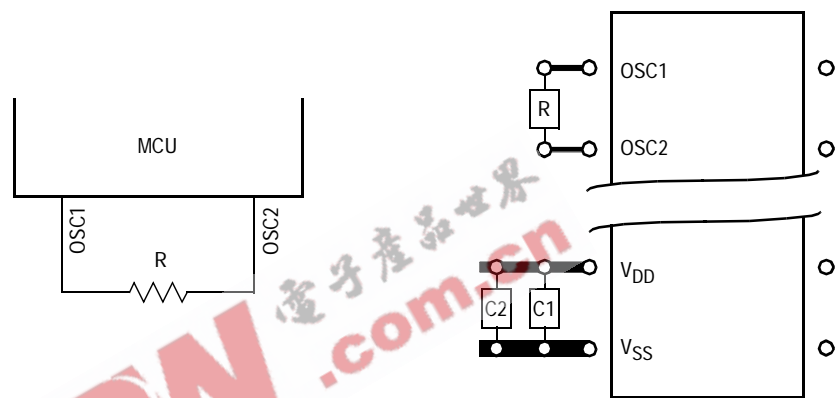

Figure 1-8. RC Oscillator Connections

1.6.2.4 External Clock

With the RC oscillator mask option, an external clock from another CMOS-compatible device can drive the OSC1 input. Leave the OSC2 pin unconnected, as **Figure 1-9** shows.

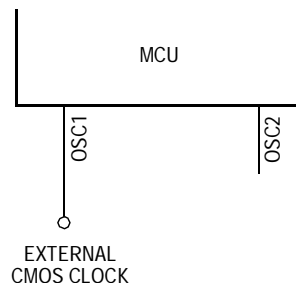

Figure 1-9. External Clock Connections

General Description

1.6.3 $\overline{\text{RESET}}$

A logic 0 on the $\overline{\text{RESET}}$ pin forces the MCU to a known startup state. See [5.3.2 External Reset](#) for more information.

1.6.4 $\overline{\text{IRQ}}$

The $\overline{\text{IRQ}}$ pin is an asynchronous external interrupt pin. See [4.3.2.1 IRQ Pin](#).

1.6.5 PA7–PA0

PA7–PA0 are the pins of port A, a general-purpose, bidirectional I/O port. See [7.4 Port A](#).

1.6.6 PB5–PB0

PB5–PB0 are the pins of port B, a general-purpose, bidirectional I/O port. See [7.5 Port B](#).

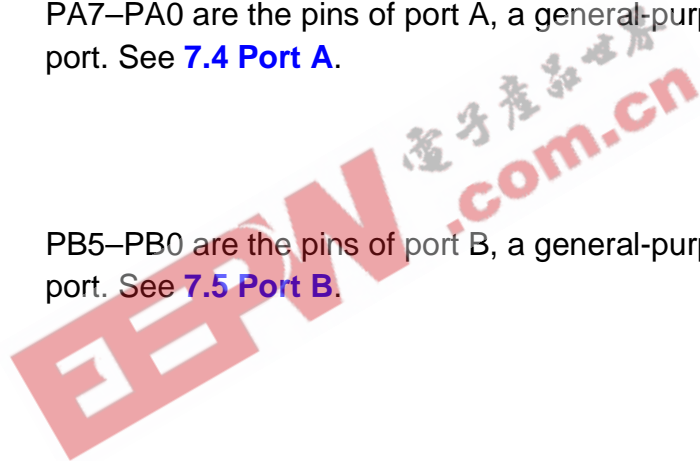

Section 2. Memory

2.1 Contents

2.2	Introduction	27
2.3	Memory Map	27
2.4	Input/Output (I/O) Section	28
2.5	Random-Access Memory (RAM)	28
2.6	Read-Only Memory (ROM)	28

2.2 Introduction

This section describes the organization of the on-chip memory.

2.3 Memory Map

The central processor unit (CPU) can address 2 Kbytes of memory space as shown in **Figure 2-1**. The read-only memory (ROM) portion of memory holds the program instructions, fixed data, user-defined vectors, and interrupt service routines. The random-access memory (RAM) portion of memory holds variable data. Input/output (I/O) registers are memory-mapped so that the CPU can access their locations in the same way that it accesses all other memory locations.

2.4 Input/Output (I/O) Section

The first 32 addresses of the memory space, \$0001–\$001F, are the I/O section. These are the addresses of the I/O control registers, status registers, and data registers. See [Figure 2-2](#).

One I/O register shown in [Figure 2-2](#) is located outside the 32-byte I/O section: the computer operating properly (COP) register is mapped at \$07F0.

2.5 Random-Access Memory (RAM)

The 64 addresses from \$00C0 to \$00FF serve as both the user RAM and the stack RAM. The CPU uses five stack RAM bytes to save all CPU register contents before processing an interrupt. During a subroutine call, the CPU uses two bytes to store the return address. The stack pointer decrements during pushes and increments during pulls.

NOTE: *Be careful when using nested subroutines or multiple interrupt levels. The CPU may overwrite data in the RAM during a subroutine or during the interrupt stacking operation.*

2.6 Read-Only Memory (ROM)

The ROM is located in two areas of the memory map:

1. Addresses \$0300–\$07CF contain 1232 bytes of user ROM.
2. Addresses \$07F8–\$07FF contain 16 bytes of ROM reserved for user vectors.

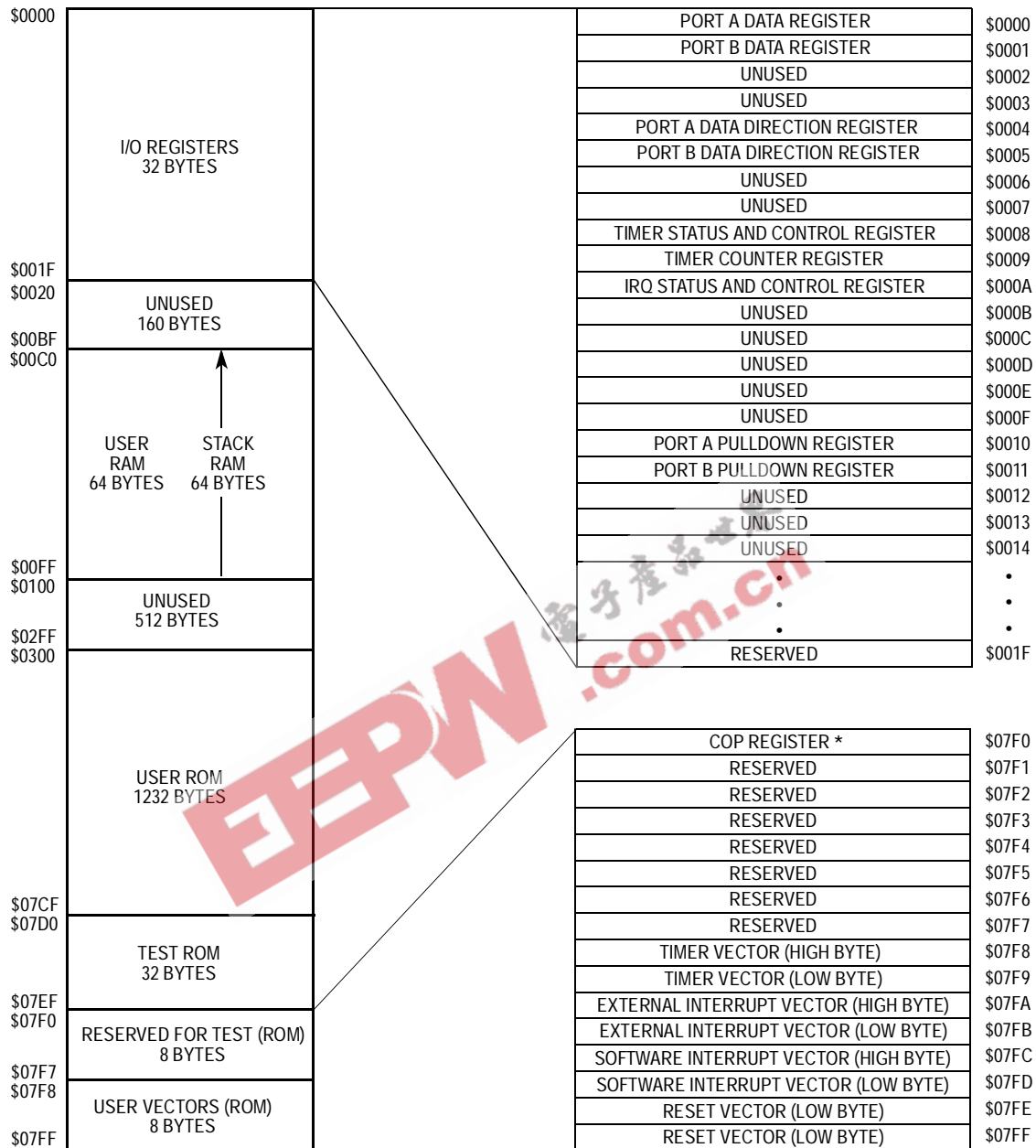

*Writing to bit 0 of \$07F0 clears the COP watchdog. Reading \$07F0 returns ROM data.

Figure 2-1. Memory Map

Freescale Semiconductor, Inc.

Memory

Addr.	Register Name	Bit 7	6	5	4	3	2	1	Bit 0	
\$0000	Port A Data Register (PORTA) See page 62.	Read:	PA7	PA6	PA5	PA4	PA3	PA2	PA1	PA0
		Write:								
		Reset:	Unaffected by reset							
\$0001	Port B Data Register (PORTB) See page 67.	Read:	0	0	PB5	PB4	PB3	PB2	PB1	PB0
		Write:								
		Reset:	Unaffected by reset							
\$0002	Unimplemented									
\$0003	Unimplemented									
\$0004	Data Direction Register A (DDRA) See page 63.	Read:	DDRA7	DDRA6	DDRA5	DDRA4	DDRA3	DDRA2	DDRA1	DDRA0
		Write:								
		Reset:	0	0	0	0	0	0	0	0
\$0005	Data Direction Register B (DDRB) See page 68.	Read:	0	0	DDRB5	DDRB4	DDRB3	DDRB2	DDRB1	DDRB0
		Write:								
		Reset:	0	0	0	0	0	0	0	0
\$0006	Unimplemented									
\$0007	Unimplemented									
\$0008	Timer Status and Control Register (TSCR) See page 73.	Read:	TOF	RTIF	TOIE	RTIE	0	0	RT1	RT0
		Write:					TOFR	RTIFR		
		Reset:	0	0	0	0	0	0	1	1
\$0009	Timer Counter Register (TCNTR) See page 75.	Read:	Bit 7	Bit 6	Bit 5	Bit 4	Bit 3	Bit 2	Bit 1	Bit 0
		Write:								
		Reset:	0	0	0	0	0	0	0	0
\$000A	IRQ Status and Control Register (ISCR) See page 45.	Read:	IRQE	IRQF	0	0	0	0		0
		Write:							IRQR	
		Reset:	1	0	0	0	0	0	0	0

= Unimplemented
 R = Reserved
 U = Unaffected

Figure 2-2. I/O Register Summary (Sheet 1 of 2)

Freescale Semiconductor, Inc.

Freescale Semiconductor, Inc.

Memory
Read-Only Memory (ROM)

Addr.	Register Name	Bit 7	6	5	4	3	2	1	Bit 0	
\$000B	Unimplemented									
↓										
\$000F	Unimplemented									
\$0010	Pulldown Register A (PDRA) See page 64.	Read:								
		Write:	PDIA7	PDIA6	PDIA5	PDIA4	PDIA3	PDIA2	PDIA1	PDIA0
		Reset:	0	0	0	0	0	0	0	0
\$0011	Pulldown Register B (PDRB) See page 69.	Read:								
		Write:			PDIB5	PDIB4	PDIB3	PDIB2	PDIB1	PDIB0
		Reset:	U	U	0	0	0	0	0	0
\$0012	Unimplemented									
↓										
\$001E	Unimplemented									
\$001F	Reserved	Read:	R	R	R	R	R	R	R	
		Write:								
		Reset:	Unaffected by reset							
\$07F0	COP Register (COPR) See page 51.	Read:								
		Write:							COPC	
		Reset:	U	U	U	U	U	U	U	0

= Unimplemented
 R = Reserved
 U = Unaffected

Figure 2-2. I/O Register Summary (Sheet 2 of 2)



Section 3. Central Processor Unit (CPU)

3.1 Contents

3.2	Introduction	33
3.3	CPU Registers	34
3.3.1	Accumulator	35
3.3.2	Index Register	35
3.3.3	Stack Pointer	36
3.3.4	Program Counter	37
3.3.5	Condition Code Register	38
3.4	Arithmetic/Logic Unit (ALU)	39

3.2 Introduction

This section describes the central processor unit (CPU) registers.

3.3 CPU Registers

Figure 3-1 shows the five CPU registers. CPU registers are not part of the memory map.

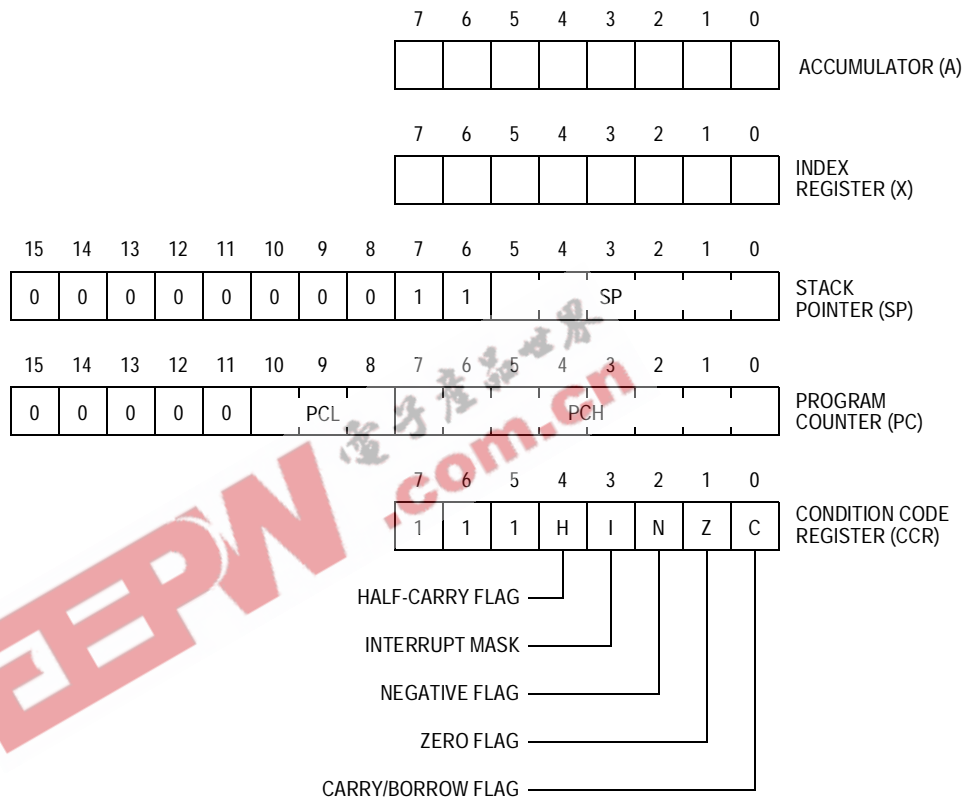

Figure 3-1. Programming Model

Freescale Semiconductor, Inc.

Central Processor Unit (CPU)
CPU Registers

3.3.1 Accumulator

The accumulator (A) shown in [Figure 3-2](#) is a general-purpose 8-bit register. The CPU uses the accumulator to hold operands and results of arithmetic and non-arithmetic operations.

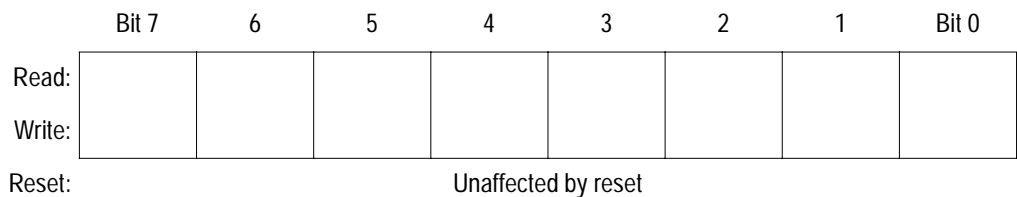

Figure 3-2. Accumulator (A)

3.3.2 Index Register

In the indexed addressing modes, the CPU uses the byte in the index register (X) shown in [Figure 3-3](#) to determine the conditional address of the operand. See [9.3.5 Indexed, No Offset](#), [9.3.6 Indexed, 8-Bit Offset](#), and [9.3.7 Indexed, 16-Bit Offset](#) for more information on indexed addressing.

The 8-bit index register also can serve as a temporary data storage location.

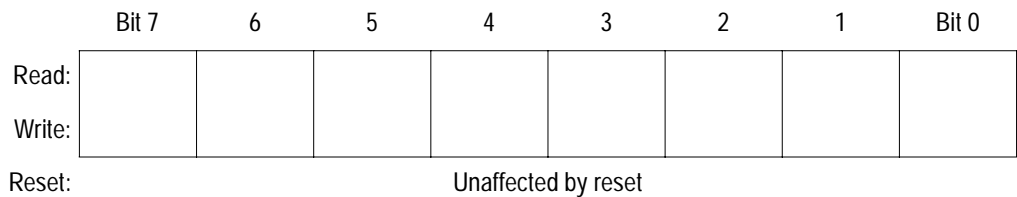

Figure 3-3. Index Register (X)

Central Processor Unit (CPU)

3.3.3 Stack Pointer

The stack pointer (SP) shown in **Figure 3-4** is a 16-bit register that contains the address of the next free location on the stack. During a reset or after the reset stack pointer (RSP) instruction, the stack pointer initializes to \$00FF. The address in the stack pointer decrements as data is pushed onto the stack and increments as data is pulled from the stack.

The 10 most significant bits of the stack pointer are fixed permanently at 0000000011, so the stack pointer produces addresses from \$00C0 to \$00FF. If subroutines and interrupts use more than 64 stack locations, the stack pointer wraps around to address \$00FF and begins writing over the previously stored data. A subroutine uses two stack locations. An interrupt uses five locations.

	Bit 15	14	13	12	11	10	9	8	7	6	5	4	3	2	1	Bit 0
Read:	0	0	0	0	0	0	0	0	1	1	0	0	0	0	0	0
Write:																
Reset:	0	0	0	0	0	0	0	0	1	1	1	1	1	1	1	1

= Unimplemented

Figure 3-4. Stack Pointer (SP)

Freescale Semiconductor, Inc.

Central Processor Unit (CPU)
CPU Registers

3.3.4 Program Counter

The program counter (PC) shown in **Figure 3-5** is a 16-bit register that contains the address of the next instruction or operand to be fetched. The five most significant bits of the program counter are ignored internally and appear as 00000.

Normally, the address in the program counter automatically increments to the next sequential memory location every time an instruction or operand is fetched. Jump, branch, and interrupt operations load the program counter with an address other than that of the next sequential location.

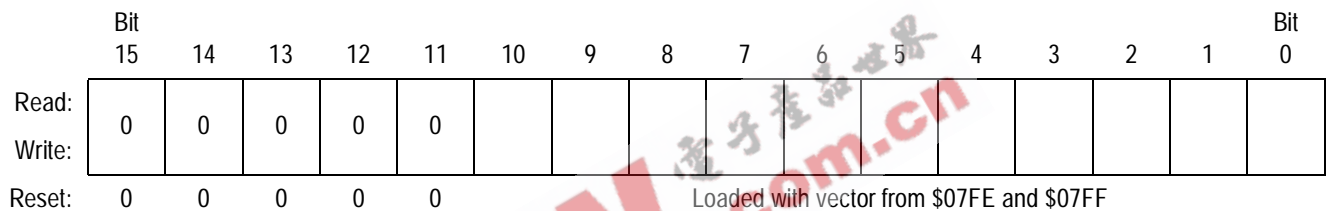

Figure 3-5. Program Counter (PC)

3.3.5 Condition Code Register

The condition code register (CCR) shown in [Figure 3-6](#) is an 8-bit register whose three most significant bits are permanently fixed at 111. The condition code register contains the interrupt mask and four flags that indicate the results of prior instructions.

	Bit 7	6	5	4	3	2	1	Bit 0
Read:	1	1	1	H	I	N	Z	C
Write:								
Reset:	1	1	1	U	1	U	U	U

= Unimplemented
 U = Unaffected

Figure 3-6. Condition Code Register (CCR)

H — Half-Carry Flag

The CPU sets the half-carry flag when a carry occurs between bits 3 and 4 of the accumulator during an add without carry (ADD) or add with carry (ADC) operation. The half-carry bit is required for binary-coded decimal (BCD) arithmetic operations. Reset has no effect on the half-carry flag.

I — Interrupt Mask Flag

Setting the interrupt mask (I) disables interrupts. If an interrupt request occurs while the interrupt mask is a logic 0, the CPU saves the CPU registers on the stack, sets the interrupt mask, and then fetches the interrupt vector. If an interrupt request occurs while the interrupt mask is set, the interrupt request is latched. The CPU processes the latched interrupt as soon as the interrupt mask is cleared again.

A return-from-interrupt (RTI) instruction pulls the CPU registers from the stack, restoring the interrupt mask to its cleared state. After a reset, the interrupt mask is set and can be cleared only by a clear interrupt mask bit (CLI), STOP, or WAIT instruction.

Freescale Semiconductor, Inc.

Central Processor Unit (CPU)
Arithmetic/Logic Unit (ALU)

N — Negative Flag

The CPU sets the negative flag when an arithmetic operation, logical operation, or data manipulation produces a negative result (bit 7 in the results is a logic 1). Reset has no effect on the negative flag.

Z — Zero Flag

The CPU sets the zero flag when an arithmetic operation, logical operation, or data manipulation produces a result of \$00. Reset has no effect on the zero flag.

C — Carry/Borrow Flag

The CPU sets the carry/borrow flag when an addition operation produces a carry out of bit 7 of the accumulator or when a subtraction operation requires a borrow. Some logical operations and data manipulation instructions also clear or set the carry/borrow bit. Reset has no effect on the carry/borrow flag.

3.4 Arithmetic/Logic Unit (ALU)

The arithmetic/logic unit (ALU) performs the arithmetic and logical operations defined by the instruction set. The binary arithmetic circuits decode instructions and set up the ALU for the selected operation. Most binary arithmetic is based on the addition algorithm, carrying out subtraction as negative addition. Multiplication is not performed as a discrete operation but as a chain of addition and shift operations within the ALU. The multiply instruction requires 11 internal clock cycles to complete this chain of operations.

EEPW 电子产品世界
.com.cn

Section 4. Interrupts

4.1 Contents

4.2	Introduction	41
4.3	Interrupt Sources	41
4.3.1	Software Interrupt	42
4.3.2	External Interrupts	42
4.3.2.1	IRQ Pin	42
4.3.2.2	PA3–PA0 Pins	44
4.3.2.3	IRQ Status and Control Register	45
4.3.3	Timer Interrupts	46
4.3.3.1	Timer Overflow Interrupt	46
4.3.3.2	Real-Time Interrupt	46
4.4	Interrupt Processing	46

4.2 Introduction

This section describes how interrupts temporarily change the normal processing sequence.

4.3 Interrupt Sources

These sources can generate interrupt requests:

- SWI (software interrupt) instruction
- $\overline{\text{IRQ}}$ pin
- PA3–PA0 pins (mask option)
- Multifunction timer

An interrupt temporarily stops normal program execution to process a particular event. An interrupt does not stop the execution of the instruction in progress, but takes effect when the current instruction completes its execution. Interrupt processing automatically saves the central processor unit (CPU) registers on the stack and loads the program counter with a user-defined vector address.

4.3.1 Software Interrupt

The software interrupt (SWI) instruction causes a non-maskable interrupt.

4.3.2 External Interrupts

These sources can generate external interrupts:

- $\overline{\text{IRQ}}$ pin
- PA3–PA0 pins (mask option)

Setting the I bit in the condition code register or clearing the IRQE bit in the interrupt status and control register disables external interrupts.

4.3.2.1 $\overline{\text{IRQ}}$ Pin

An interrupt signal on the $\overline{\text{IRQ}}$ pin latches an external interrupt request. When the CPU completes its current instruction, it tests the IRQ latch. If the IRQ latch is set, the CPU then tests the I bit in the condition code register and the IRQE bit in the interrupt status and control register. If the I bit is clear and the IRQE bit is set, the CPU then begins the interrupt sequence. The CPU clears the IRQ latch while it fetches the interrupt vector, so that another external interrupt request can be latched during the interrupt service routine. As soon as the I bit is cleared during the return from interrupt, the CPU can recognize the new interrupt request. **Figure 4-1** shows the external interrupt logic.

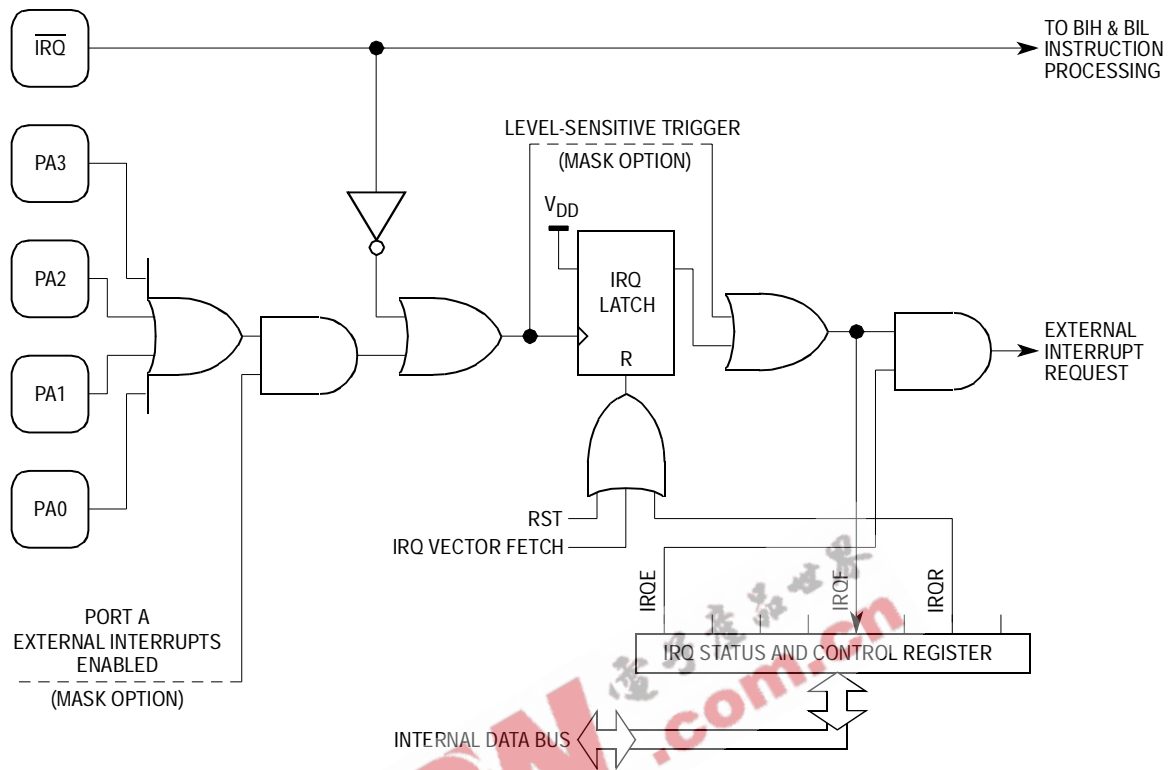

Figure 4-1. External Interrupt Logic

External interrupt triggering sensitivity is a mask option. The $\overline{\text{IRQ}}$ pin can be negative edge-triggered only or negative edge- and low level-triggered.

With the mask option for an edge- and level-sensitive external interrupt trigger, a falling edge or a low level on the $\overline{\text{IRQ}}$ pin latches an external interrupt request. Edge- and level-sensitive triggering allows the use of multiple wired-OR external interrupt sources. An external interrupt request is latched as long as any source is holding the $\overline{\text{IRQ}}$ pin low.

With the mask option for an edge-sensitive only external interrupt trigger, a falling edge on the $\overline{\text{IRQ}}$ pin latches an external interrupt request. A subsequent external interrupt request can be latched only after the voltage level on the $\overline{\text{IRQ}}$ pin returns to logic 1 and then falls again to logic 0.

4.3.2.2 PA3–PA0 Pins

The mask option for port A external interrupts enables pins PA3–PA0 to serve as additional external interrupt sources. An interrupt signal on a PA3–PA0 pin latches an external interrupt request. After completing the current instruction, the CPU tests the IRQ latch. If the IRQ latch is set, the CPU then tests the I bit in the condition code register and the IRQE bit in the interrupt status and control register. If the I bit is clear and the IRQE bit is set, the CPU then begins the interrupt sequence. The CPU clears the IRQ latch while it fetches the interrupt vector, so that another external interrupt request can be latched during the interrupt service routine. As soon as the I bit is cleared during the return from interrupt, the CPU can recognize the new interrupt request.

External interrupt triggering sensitivity is a mask option. The PA3–PA0 pins can be positive edge-triggered only or positive edge- and high level-triggered.

With the mask option for an edge- and level-sensitive external interrupt trigger, a rising edge or a high level on a PA3–PA0 pin latches an external interrupt request. Edge- and level-sensitive triggering allows the use of multiple wired-OR external interrupt sources. As long as any source is holding a PA3–PA0 pin high, an external interrupt request is latched, and the CPU continues to execute the interrupt service routine.

With the mask option for an edge-sensitive only external interrupt trigger, a rising edge on a PA3–PA0 pin latches an external interrupt request. A subsequent external interrupt request can be latched only after the voltage level of the previous interrupt signal returns to logic 0 and then rises again to logic 1.

4.3.2.3 IRQ Status and Control Register

The IRQ status and control register (ISCR), shown in **Figure 4-2**, contains an external interrupt mask, an external interrupt flag, and a flag reset bit.

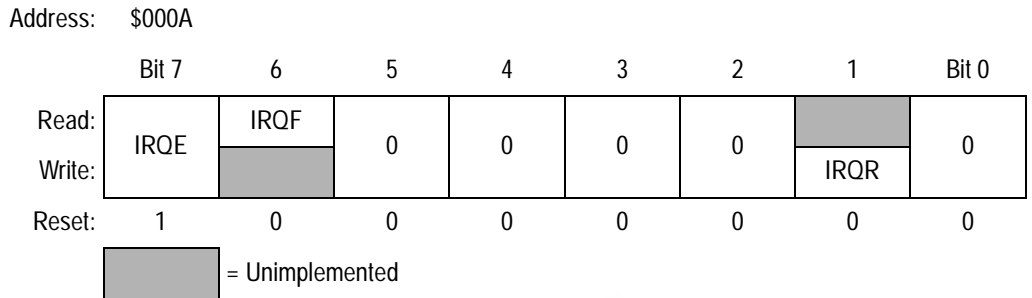

Figure 4-2. IRQ Status and Control Register (ISCR)

IRQE — External Interrupt Request Enable Bit

This read/write bit enables external interrupts. Resets set the IRQE bit.

- 1 = External interrupt processing enabled
- 0 = External interrupt processing disabled

IRQF — External Interrupt Request Flag

The IRQ flag is a clearable, read-only bit that is set when an external interrupt request is pending. Resets clear the IRQF bit.

- 1 = Interrupt request pending
- 0 = No interrupt request pending

These conditions set the IRQ flag:

- a. An external interrupt signal on the \overline{IRQ} pin
- b. An external interrupt signal on pin PA3, PA2, PA1, or PA0 when PA3–PA0 are enabled to serve as external interrupt sources

The CPU clears the IRQ flag when fetching the interrupt vector. Writing to the IRQ flag has no effect. Clear the IRQ flag by writing a logic 1 to the IRQR bit.

IRQR — Interrupt Request Reset Bit

This write-only bit clears the IRQ flag.

- 1 = IRQF bit cleared
- 0 = No effect

4.3.3 Timer Interrupts

The multifunction timer can generate these interrupts:

- Timer overflow interrupt
- Real-time interrupt

Setting the I bit in the condition code register disables timer interrupts.

4.3.3.1 Timer Overflow Interrupt

A timer overflow interrupt request occurs if the timer overflow flag, TOF, becomes set while the timer overflow interrupt enable bit, TOIE, is also set. See [8.3 Timer Status and Control Register](#).

4.3.3.2 Real-Time Interrupt

A real-time interrupt request occurs if the real-time interrupt flag, RTIF, becomes set while the real-time interrupt enable bit, RTIE, is also set. See [8.3 Timer Status and Control Register](#).

4.4 Interrupt Processing

The CPU takes these actions to begin servicing an interrupt:

- Stores the CPU registers on the stack in the order shown in [Figure 4-3](#)
- Sets the I bit in the condition code register to prevent further interrupts
- Loads the program counter with the contents of the appropriate interrupt vector locations:
 - \$07FC and \$07FD (software interrupt vector)
 - \$07FA and \$07FB (external interrupt vector)
 - \$07F8 and \$07F9 (timer interrupt vector)

The return-from-interrupt (RTI) instruction causes the CPU to recover the CPU registers from the stack as shown in [Figure 4-3](#).

Freescale Semiconductor, Inc.

Interrupts
Interrupt Processing

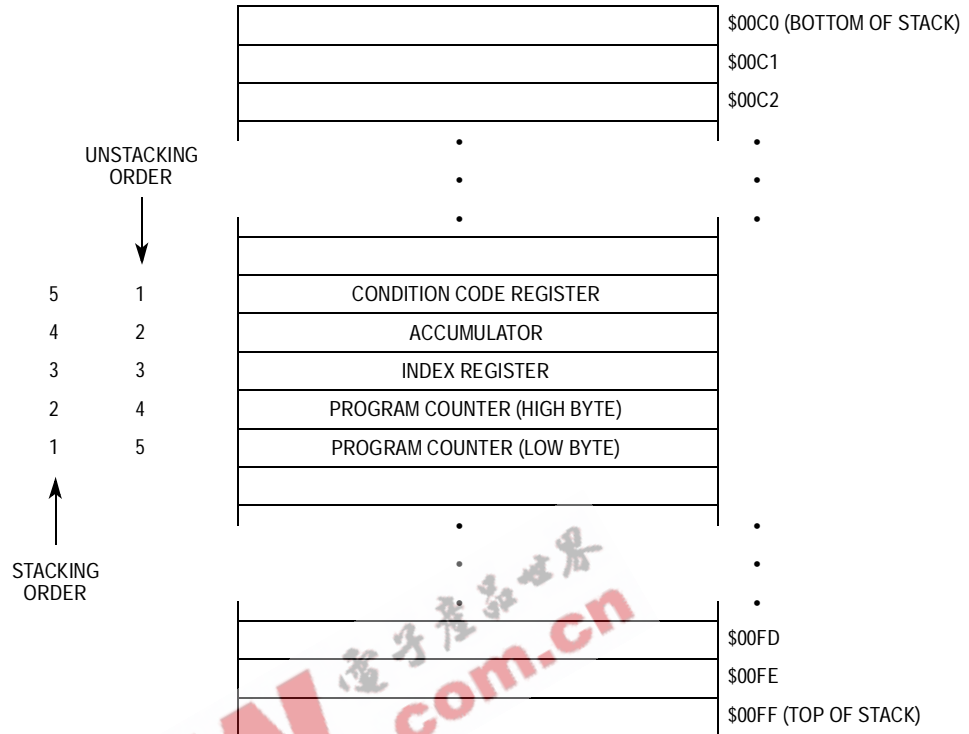

Figure 4-3. Stacking Order

Table 4-1 summarizes the reset and interrupt sources and vector assignments.

Table 4-1. Reset/Interrupt Vector Addresses

Function	Source	Local Mask	Global Mask	Priority (1 = Highest)	Vector Address
Reset	Power-on	None	None	1	\$07FE-\$07FF
	RESET pin		None	1	
	COP watchdog ⁽¹⁾		None	1	
	illegal address		None	1	
Software interrupt (SWI)	User code	None	None	Same priority as instruction	\$07FC-\$07FD
External interrupt	IRQ pin PA3 pin ⁽²⁾ PA2 pin ⁽²⁾ PA1 pin ⁽²⁾ PA0 pin ⁽²⁾	IRQE bit	I bit	2	\$07FA-\$07FB
Timer interrupts	TOF bit RTIF bit	TOFE bit RTIE bit	I bit	3	\$07F8-\$07F9

1. The COP watchdog is a mask option.
2. Port A external interrupt capability is a mask option.

Figure 4-4 shows the sequence of events caused by an interrupt.

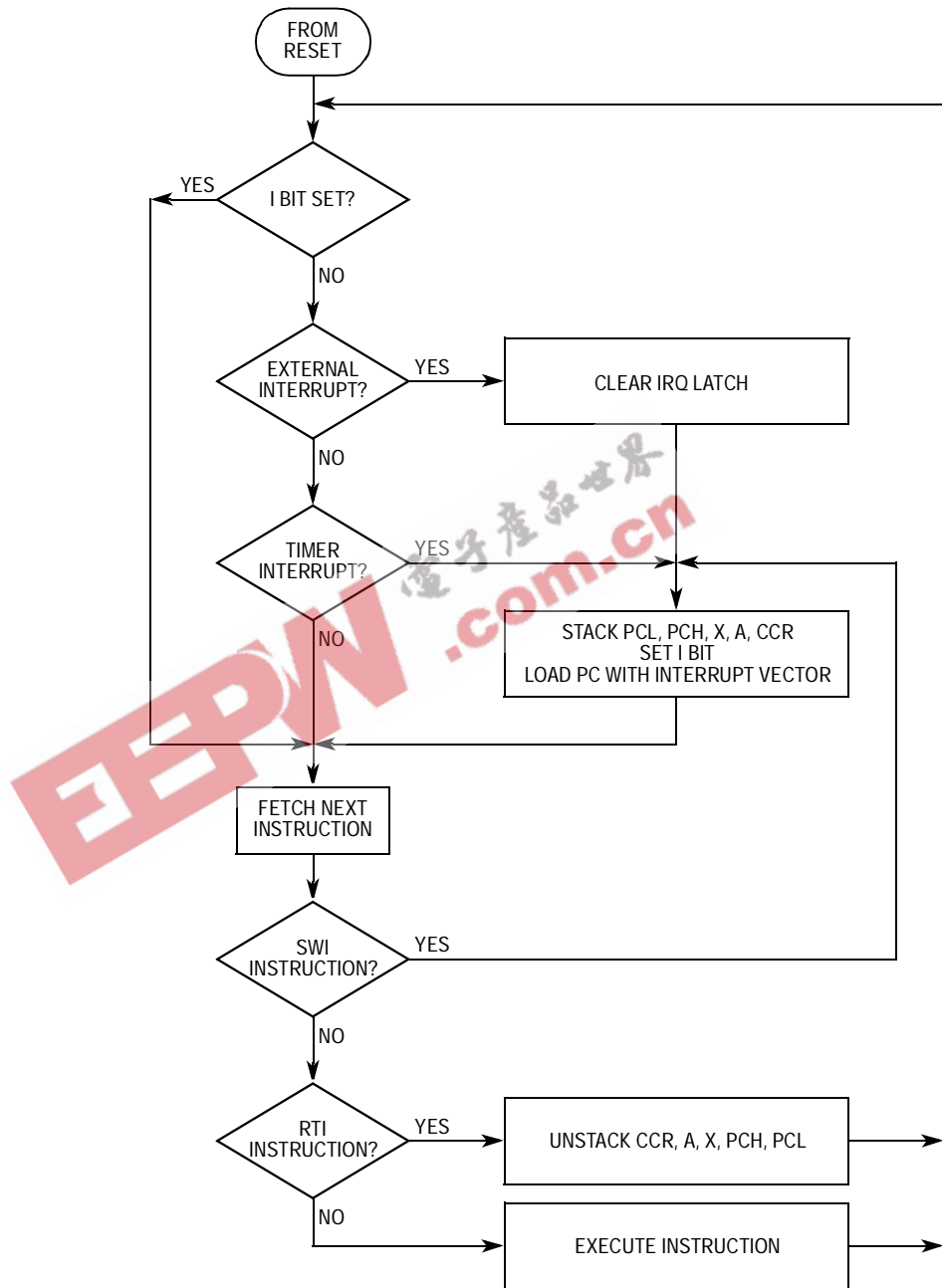

Figure 4-4. Interrupt Flowchart

Section 5. Resets

5.1 Contents

5.2	Introduction	49
5.3	Reset Types	50
5.3.1	Power-On Reset	50
5.3.2	External Reset	51
5.3.3	Computer Operating Properly (COP) Reset	51
5.3.4	Illegal Address Reset	52
5.4	Reset States	52
5.4.1	CPU	52
5.4.2	I/O Port Registers	52
5.4.3	Multifunction Timer	53
5.4.4	COP Watchdog	53

5.2 Introduction

This section describes the four reset sources and how they initialize the microcontroller unit (MCU).

5.3 Reset Types

A reset immediately stops the operation of the instruction being executed, initializes certain control bits, and loads the program counter with a user-defined reset vector address. These conditions produce a reset:

- Initial power-up (power-on reset)
- A logic 0 applied to the $\overline{\text{RESET}}$ pin (external reset)
- Timeout of the mask-optional computer operating properly (COP) watchdog (COP reset)
- An opcode fetch from an address not in the memory map (illegal address reset)

Figure 5-1 is a block diagram of the reset sources.

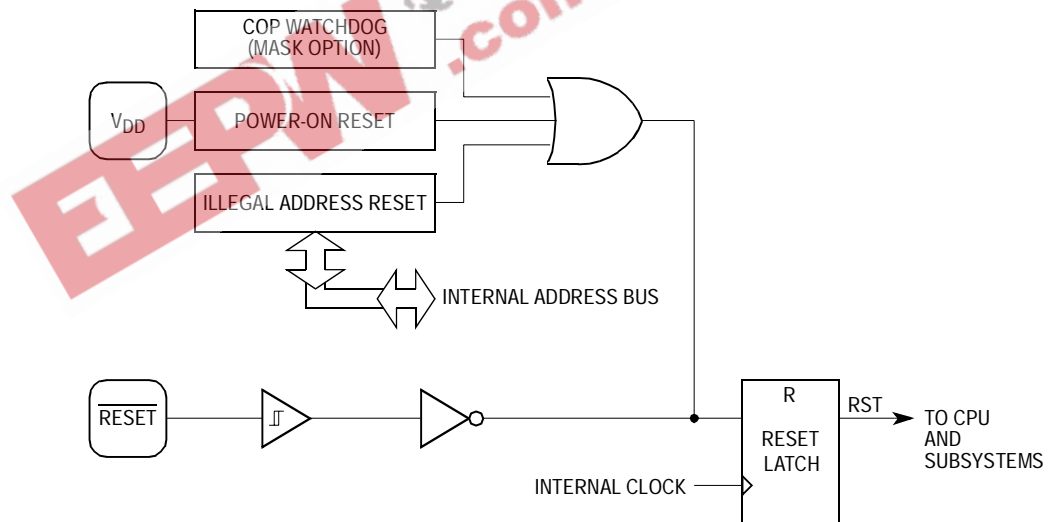

Figure 5-1. Reset Sources

5.3.1 Power-On Reset

A positive transition on the V_{DD} pin generates a power-on reset. The power-on reset is strictly for power-up conditions and cannot be used to detect drops in power supply voltage.

A 4064 t_{CYC} (internal clock cycle) delay after the oscillator becomes active allows the clock generator to stabilize. If the \overline{RESET} pin is at logic 0 at the end of 4064 t_{CYC} , the MCU remains in the reset condition until the signal on the \overline{RESET} pin goes to logic 1.

5.3.2 External Reset

A logic 0 applied to the \overline{RESET} pin for one and one-half t_{CYC} generates an external reset. A Schmitt trigger senses the logic level at the \overline{RESET} pin.

5.3.3 Computer Operating Properly (COP) Reset

A timeout of the COP watchdog generates a COP reset. The COP watchdog is part of a software error detection system and must be cleared periodically to start a new timeout period. See [8.4 COP Watchdog](#).

To clear the COP watchdog and prevent a COP reset, write a logic 0 to bit 0 (COPC) of the COP register at location \$07F0. The COP register, shown in [Figure 5-2](#), is a write-only register that returns the contents of a ROM location when read.

The COP watchdog function is a mask option.

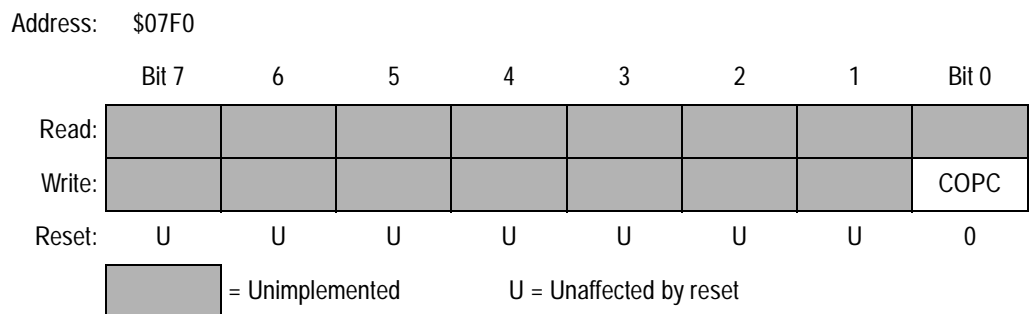

Figure 5-2. COP Register (COPR)

COPC — COP Clear Bit

COPC is a write-only bit. Periodically writing a logic 0 to COPC prevents the COP watchdog from resetting the MCU.

5.3.4 Illegal Address Reset

An opcode fetch from an address that is not in the ROM (locations \$0300–\$07FF) or the RAM (locations \$00C0–\$00FF) generates an illegal address reset.

5.4 Reset States

This subsection describes how resets initialize the MCU.

5.4.1 CPU

A reset has the following effects on the CPU:

- Loads the stack pointer with \$FF
- Sets the I bit in the condition code register, inhibiting interrupts
- Sets the IRQE bit in the interrupt status and control register
- Loads the program counter with the user-defined reset vector from locations \$07FE and \$07FF
- Clears the stop latch, enabling the CPU clock
- Clears the wait latch, waking the CPU from the wait mode

5.4.2 I/O Port Registers

A reset has these effects on I/O port registers:

- Clears bits DDRA7–DDRA0 in data direction register A so that port A pins are inputs
- Clears bits PDIA7–PDIA0 in pulldown register A so that port A pulldown devices are enabled
- Clears bits DDRB5–DDRB0 in data direction register B so that port B pins are inputs
- Clears bits PDIB5–PDIB0 in pulldown register B so that port B pulldown devices are enabled
- Has no effect on port A or port B data registers

5.4.3 Multifunction Timer

A reset has these effects on the multifunction timer:

- Clears the timer status and control register
- Clears the timer counter register

5.4.4 COP Watchdog

A reset clears the COP watchdog, if the COP watchdog is enabled by mask option.





Section 6. Low-Power Modes

6.1 Contents

6.2	Introduction	55
6.3	Stop Mode	55
6.4	Wait Mode	56
6.5	Halt Mode	57
6.6	Data-Retention Mode	59

6.2 Introduction

This section describes the four low-power modes:

- Stop mode
- Wait mode
- Halt mode (mask option)
- Data-retention mode

6.3 Stop Mode

The STOP instruction puts the microcontroller unit (MCU) in its lowest power-consumption mode and has these effects on the MCU:

- Clears TOF and RTIF, the timer interrupt flags in the timer status and control register, removing any pending timer interrupts
- Clears TOIE and RTIE, the timer interrupt enable bits in the timer status and control register, disabling further timer interrupts
- Clears the multifunction timer counter

- Sets the IRQE bit in the IRQ status and control register to enable external interrupts
- Clears the I bit in the condition code register, enabling interrupts
- Stops the internal oscillator, turning off the central processor unit (CPU) clock and the timer clock, including the computer operating properly (COP) watchdog

The STOP instruction does not affect any other registers or any input/output (I/O) lines.

These conditions bring the MCU out of stop mode:

- An external interrupt signal on the $\overline{\text{IRQ}}$ pin — A high-to-low transition on the $\overline{\text{IRQ}}$ pin loads the program counter with the contents of locations \$07FA and \$07FB.
- An external interrupt signal on a port A external interrupt pin — If the mask option for the port A external interrupt function is selected, a low-to-high transition on a PA3–PA0 pin loads the program counter with the contents of locations \$07FA and \$07FB.
- External reset — A logic 0 on the $\overline{\text{RESET}}$ pin resets the MCU and loads the program counter with the contents of locations \$07FE and \$07FF.

When the MCU exits stop mode, processing resumes after a stabilization delay of 4064 oscillator cycles.

6.4 Wait Mode

The WAIT instruction puts the MCU in an intermediate power-consumption mode and has these effects on the MCU:

- Clears the I bit in the condition code register, enabling interrupts
- Sets the IRQE bit in the IRQ status and control register, enabling external interrupts
- Stops the central processor unit (CPU) clock, but allows the internal oscillator and timer clock to continue to run

The WAIT instruction does not affect any other registers or any I/O lines.

These conditions restart the CPU clock and bring the MCU out of wait mode:

- An external interrupt signal on the $\overline{\text{IRQ}}$ pin — A high-to-low transition on the $\overline{\text{IRQ}}$ pin loads the program counter with the contents of locations \$07FA and \$07FB.
- An external interrupt signal on a port A external interrupt pin — If the mask option for the port A external interrupt function is selected, a low-to-high transition on a PA3–PA0 pin loads the program counter with the contents of locations \$07FA and \$07FB.
- A timer interrupt — A timer overflow or a real-time interrupt request loads the program counter with the contents of locations \$07F8 and \$07F9.
- A COP watchdog reset — A timeout of the mask-optional COP watchdog resets the MCU and loads the program counter with the contents of locations \$07FE and \$07FF. Software can enable real-time interrupts so that the MCU can periodically exit wait mode to reset the COP watchdog.
- External reset — A logic 0 on the $\overline{\text{RESET}}$ pin resets the MCU and loads the program counter with the contents of locations \$07FE and \$07FF.

6.5 Halt Mode

If the mask option to disable the STOP instruction is selected, a STOP instruction puts the MCU in halt mode. The halt mode is identical to the wait mode, except that a recovery delay of 1–4064 internal clock cycles occurs when the MCU exits the halt mode. If the mask option to disable the STOP instruction is selected, the COP watchdog cannot be inadvertently turned off by a STOP instruction.

Figure 6-1 shows the sequence of events in stop, wait, and halt modes.

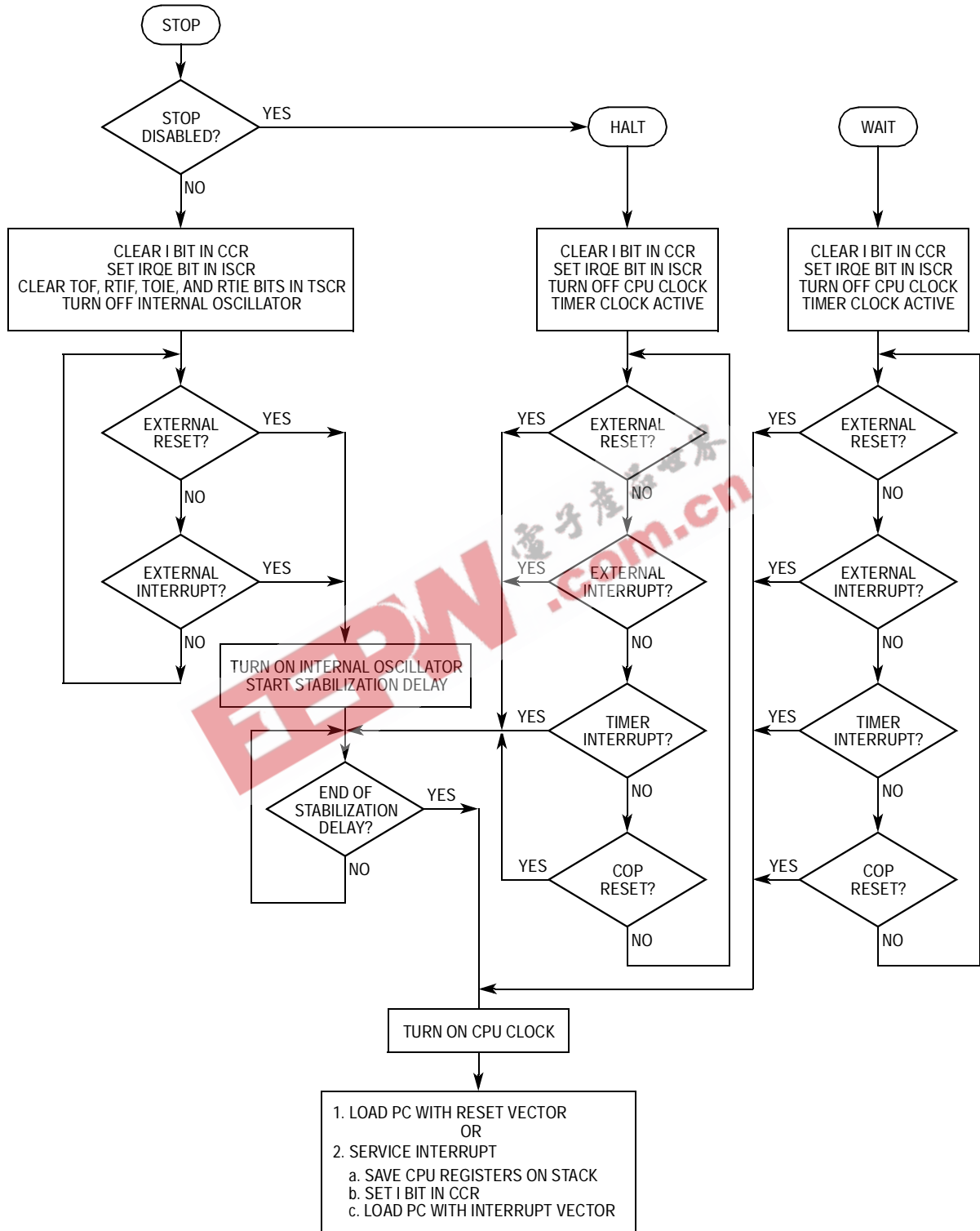

Figure 6-1. Stop/Wait/Halt Flowchart

6.6 Data-Retention Mode

In data-retention mode, the MCU retains random-access memory (RAM) contents and CPU register contents at V_{DD} voltages as low as 2.0 Vdc. The data-retention feature allows the MCU to remain in a low power-consumption state during which it retains data, but the CPU cannot execute instructions.

To put the MCU in data-retention mode:

1. Drive the $\overline{\text{RESET}}$ pin to logic 0.
2. Lower the V_{DD} voltage. The $\overline{\text{RESET}}$ pin must remain low continuously during data-retention mode.

To take the MCU out of data-retention mode:

1. Return V_{DD} to normal operating voltage.
2. Return the $\overline{\text{RESET}}$ pin to logic 1.

EEPW 电子产品世界
.com.cn

Section 7. Parallel Input/Output (I/O)

7.1 Contents

7.2	Introduction	61
7.3	I/O Port Function	61
7.4	Port A	62
7.4.1	Port A Data Register	62
7.4.2	Data Direction Register A	63
7.4.3	Pulldown Register A	64
7.4.4	Port A External Interrupts	65
7.5	Port B	67
7.5.1	Port B Data Register	67
7.5.2	Data Direction Register B	68
7.5.3	Pulldown Register B	69

7.2 Introduction

This section describes the two bidirectional input/output (I/O) ports.

7.3 I/O Port Function

The 14 bidirectional I/O pins form two parallel I/O ports. Each I/O pin is programmable as an input or an output. The contents of the data direction registers determine the data direction of each I/O pin.

All 14 I/O pins have mask-optional, software-programmable pulldown devices.

7.4 Port A

Port A is an 8-bit, general-purpose, bidirectional I/O port with these features:

- Programmable pulldown devices (mask option)
- 8-mA current sinking capability (pins PA7–PA4)
- External interrupt capability (mask option: pins PA3–PA0)

7.4.1 Port A Data Register

The port A data register (PORTA) contains a bit for each of the port A pins. When a port A pin is programmed to be an output, the state of its data register bit determines the state of the output pin. When a port A pin is programmed to be an input, reading the port A data register returns the logic state of the pin.

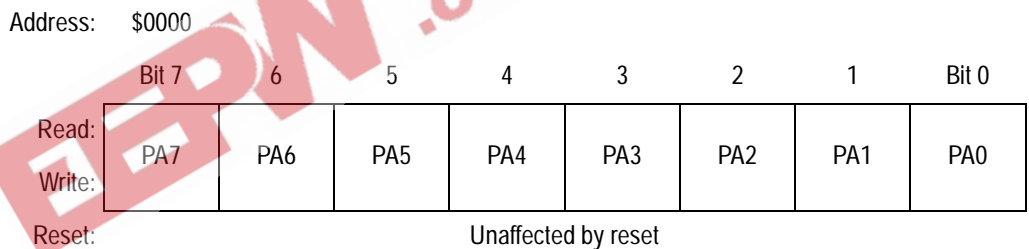

Figure 7-1. Port A Data Register (PORTA)

PA7–PA0 — Port A Data Bits

These read/write bits are software-programmable. Data direction of each bit is under the control of the corresponding bit in data direction register A. Resets have no effect on port A data.

7.4.2 Data Direction Register A

The contents of data direction register A (DDRA) determine whether each port A pin is an input or an output. Writing a logic 1 to a DDRA bit enables the output buffer for the associated port A pin; a logic 0 disables the output buffer. A reset initializes all DDRA bits to 0, configuring all port A pins as inputs.

Address: \$0004

	Bit 7	6	5	4	3	2	1	Bit 0
Read:	DDRA7	DDRA6	DDRA5	DDRA4	DDRA3	DDRA2	DDRA1	DDRA0
Write:								
Reset:	0	0	0	0	0	0	0	0

Figure 7-2. Data Direction Register A (DDRA)

DDRA7–DDRA0 — Port A Data Direction Bits

These read/write bits control port A data direction.

1 = Corresponding port A pin configured as output

0 = Corresponding port A pin configured as input

NOTE: *Avoid glitches on port A pins by writing to the port A data register before changing DDRA bits from logic 0 to logic 1.*

7.4.3 Pulldown Register A

All port A pins have mask-optional, programmable pulldown devices that typically sink 100 μ A. Clearing the PDIA7–PDIA0 bits in pulldown register A (PDRA) turns on the pulldown devices. See [Figure 7-3](#).

Pulldown register A can turn on a port A pulldown device only when the port A pin is an input. Reset clears the PDIA7–PDIA0 bits, turning on all the port A pulldown devices.

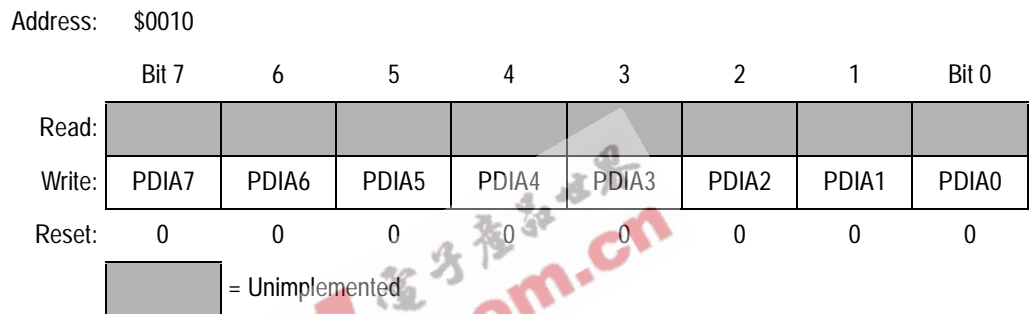

Figure 7-3. Pulldown Register A (PDRA)

PDIA7–PDIA0 — Port A Pulldown Inhibit Bits

Writing logic 0s to these write-only bits turns on the port A pulldown devices. Reading pulldown register A returns undefined data.

- 1 = Corresponding port A pin pulldown device turned off
- 0 = Corresponding port A pin pulldown device turned on

NOTE: Avoid a floating port A input by clearing its pulldown register bit before changing its DDRA bit from logic 1 to logic 0.

Do not use read-modify-write instructions on pulldown register A.

7.4.4 Port A External Interrupts

If the port A external interrupt mask option is selected, the PA3–PA0 pins serve as external interrupt pins in addition to the \overline{IRQ} pin.

External interrupt triggering sensitivity is a mask option. The PA3–PA0 pins can be positive edge-triggered or positive edge- and high level-triggered.

NOTE: When testing for external interrupts, the BIH and BIL instructions test the voltage on the \overline{IRQ} pin, not the state of the internal IRQ signal. Therefore, BIH and BIL cannot test the port A external interrupt pins.

Figure 7-4 shows the port A I/O logic.

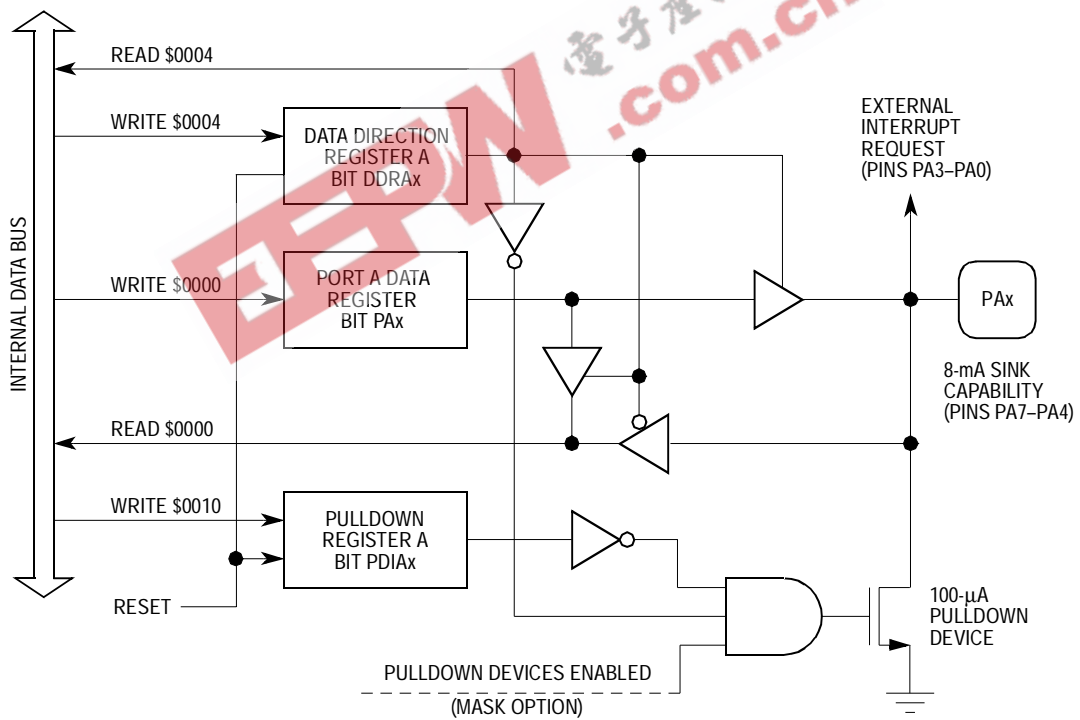

Figure 7-4. Port A I/O Circuit

Parallel Input/Output (I/O)

When a port A pin is programmed as an output, reading the port bit actually reads the value of the data latch and not the voltage on the pin itself. When a port A pin is programmed as an input, reading the port bit reads the voltage level on the pin. The data latch can always be written, regardless of the state of its DDR bit. [Table 7-1](#) summarizes the operations of the port A pins.

Table 7-1. Port A Pin Functions

Pulldown Mask Option	Control Bits		I/O Pin Mode	Accesses to PDRA		Accesses to DDRA	Accesses to PORTA	
	PDIAx	DDRAx		Read	Write	Read/Write	Read	Write
No	X ⁽¹⁾	0	Input, hi-z	U ⁽²⁾	PDIA7–PDIA0	DDRA7–DDRA0	Pin	PA7–PA0
No	X	1	Output	U	PDIA7–PDIA0	DDRA7–DDRA0	PA7–PA0	PA7–PA0
Yes	0	0	Input, pulldown on	U	PDIA7–PDIA0	DDRA7–DDRA0	Pin	PA7–PA0
Yes	0	1	Output, pulldown on	U	PDIA7–PDIA0	DDRA7–DDRA0	PA7–PA0	PA7–PA0
Yes	1	0	Input, hi-z	U	PDIA7–PDIA0	DDRA7–DDRA0	Pin	PA7–PA0
Yes	1	1	Output	U	PDIA7–PDIA0	DDRA7–DDRA0	PA7–PA0	PA7–PA0

1. X = Don't care
2. U = Undefined

7.5 Port B

Port B is a 6-bit, general-purpose, bidirectional I/O port with programmable pulldown devices.

7.5.1 Port B Data Register

The port B data register (PORTB) contains a bit for each of the port B pins. When a port B pin is programmed to be an output, the state of its data register bit determines the state of the output pin. When a port B pin is programmed to be an input, reading the port B data register returns the logic state of the pin.

Address: \$0001

	Bit 7	6	5	4	3	2	1	Bit 0
Read:	0	0	PB5	PB4	PB3	PB2	PB1	PB0
Write:								
Reset:	Unaffected by reset							

= Unimplemented

Figure 7-5. Port B Data Register (PORTB)

PB5–PB0 — Port B Data Bits

These read/write bits are software programmable. Data direction of each bit is under the control of the corresponding bit in the port B data direction register.

Bits 7 and 6 — Not used

Bits 7 and 6 always read as logic 0s. Writes to these bits have no effect.

7.5.2 Data Direction Register B

The contents of data direction register B (DDRB) determine whether each port B pin is an input or an output. Writing a logic 1 to a DDRB bit enables the output buffer for the associated port B pin; a logic 0 disables the output buffer. A reset initializes all DDRB bits to logic 0, configuring all port B pins as inputs.

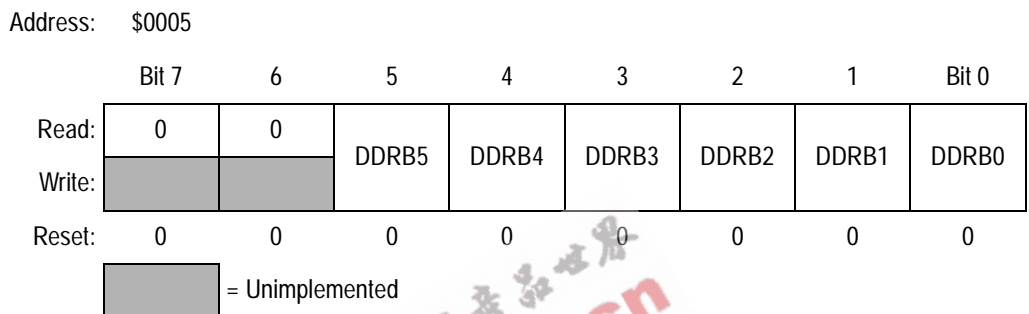

Figure 7-6. Data Direction Register B (DDRB)

DDRB5–DDRB0 — Data Direction Bits

- These read/write bits control port B data direction.
- 1 = Corresponding port B pin configured as output
- 0 = Corresponding port B pin configured as input

Bit 7 and 6 — Not used

Bits 7 and 6 always read as logic 0s. Writes to these bits have no effect.

NOTE: Avoid glitches on port B pins by writing to the port B data register before changing DDRB bits from logic 0 to logic 1.

7.5.3 Pulldown Register B

All port B pins have mask-optional, programmable pulldown devices that typically sink 100 μ A. Clearing any of the PDIB5–PDIB0 bits in pulldown register B (PDRB) turns on the pulldown devices. See [Figure 7-7](#).

Pulldown register B can turn on a port B pulldown device only when the port B pin is an input. Reset clears bits PDIB5–PDIB0, turning on the port B pulldown devices.

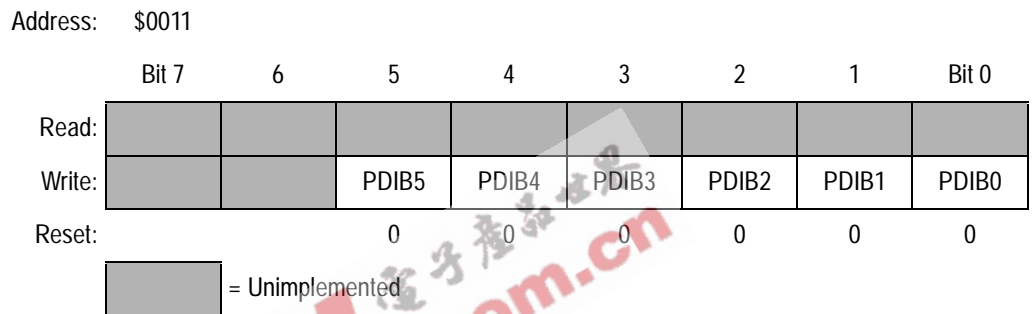

Figure 7-7. Pulldown Register B (PDRB)

PDIB5–PDIB0 — Pulldown Inhibit Bits

Writing logic 0s to these write-only bits turns on the port B pulldown devices. Reading pulldown register B returns undefined data.

- 1 = Corresponding port B pin pulldown device turned off
- 0 = Corresponding port B pin pulldown device turned on

Bits 7 and 6 — Not used

NOTE: Avoid a floating port B input by clearing its pulldown register bit before changing its DDRB bit from logic 1 to logic 0.

Do not use read-modify-write instructions on pulldown register B.

[Figure 7-8](#) shows the port B I/O logic.

Reading a port B output actually reads the value of the data latch and not the voltage on the pin itself. When a port B pin is programmed as an input, reading the port bit reads the voltage level on the pin. The data latch can always be written, regardless of the state of its DDR bit.

[Table 7-2](#) summarizes the operation of the port B pins.

Parallel Input/Output (I/O)

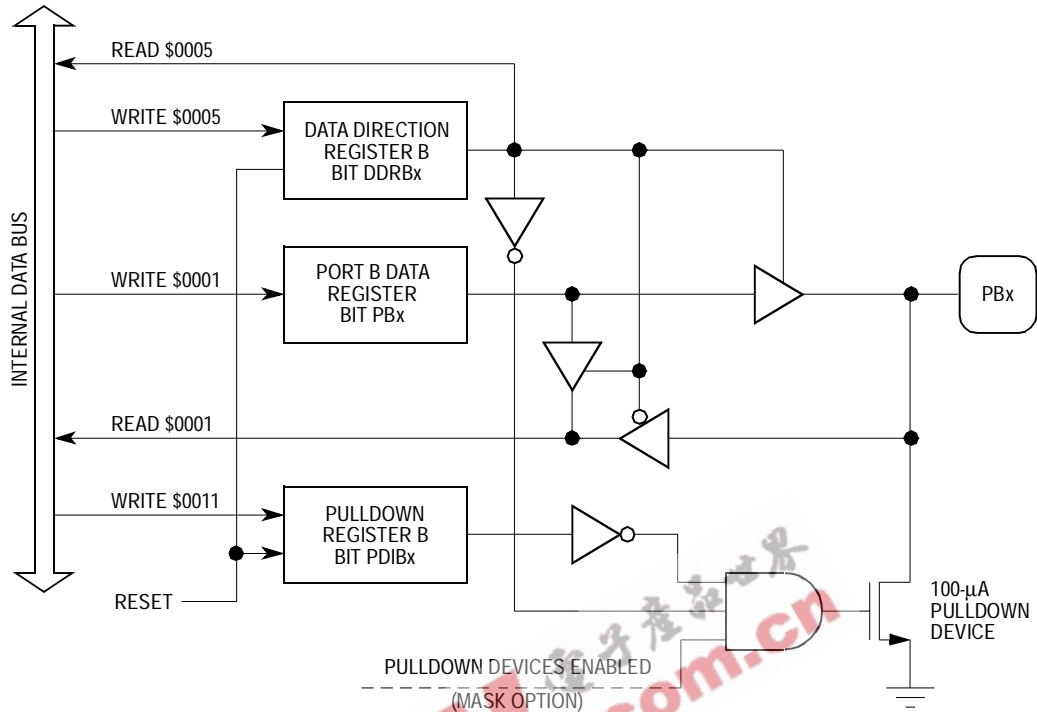

Figure 7-8. Port B I/O Circuit

Table 7-2. Port B Pin Functions

Pull-down Mask Option	Control Bits		I/O Pin Mode	Accesses to PDRB		Accesses to DDRB	Accesses to PORTB	
	PDIBx	DDRBx		Read	Write		Read	Write
No	X ⁽¹⁾	0	Input, hi-z	U ⁽²⁾	PDIB7–PDIB0	DDRB7–DDRB0	Pin	PB7–PB0
No	X	1	Output	U	PDIB7–PDIB0	DDRB7–DDRB0	PB7–PB0	PB7–PB0
Yes	0	0	Input, pull-down on	U	PDIB7–PDIB0	DDRB7–DDRB0	Pin	PB7–PB0
Yes	0	1	Output, pull-down on	U	PDIB7–PDIB0	DDRB7–DDRB0	PB7–PB0	PB7–PB0
Yes	1	0	Input, hi-z	U	PDIB7–PDIB0	DDRB7–DDRB0	Pin	PB7–PB0
Yes	1	1	Output	U	PDIB7–PDIB0	DDRB7–DDRB0	PB7–PB0	PB7–PB0

1. X = Don't care
2. U = Undefined

Section 8. Multifunction Timer

8.1 Contents

8.2	Introduction	71
8.3	Timer Status and Control Register	73
8.4	COP Watchdog	76

8.2 Introduction

This section describes the operation of the multifunction timer and the computer operating properly (COP) watchdog. **Figure 8-1** shows the organization of the timer subsystem.

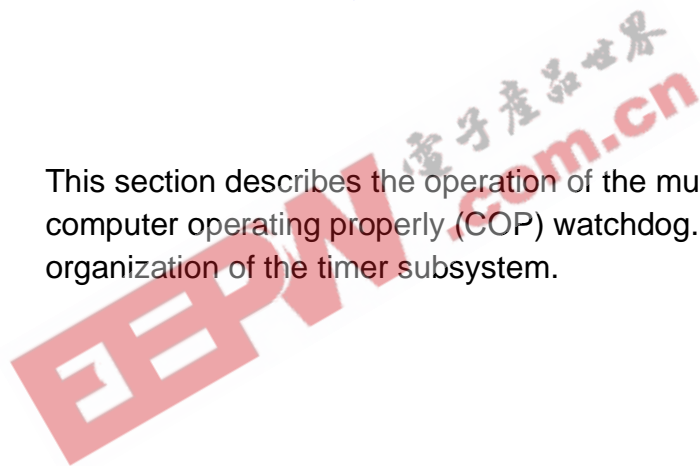

Multifunction Timer

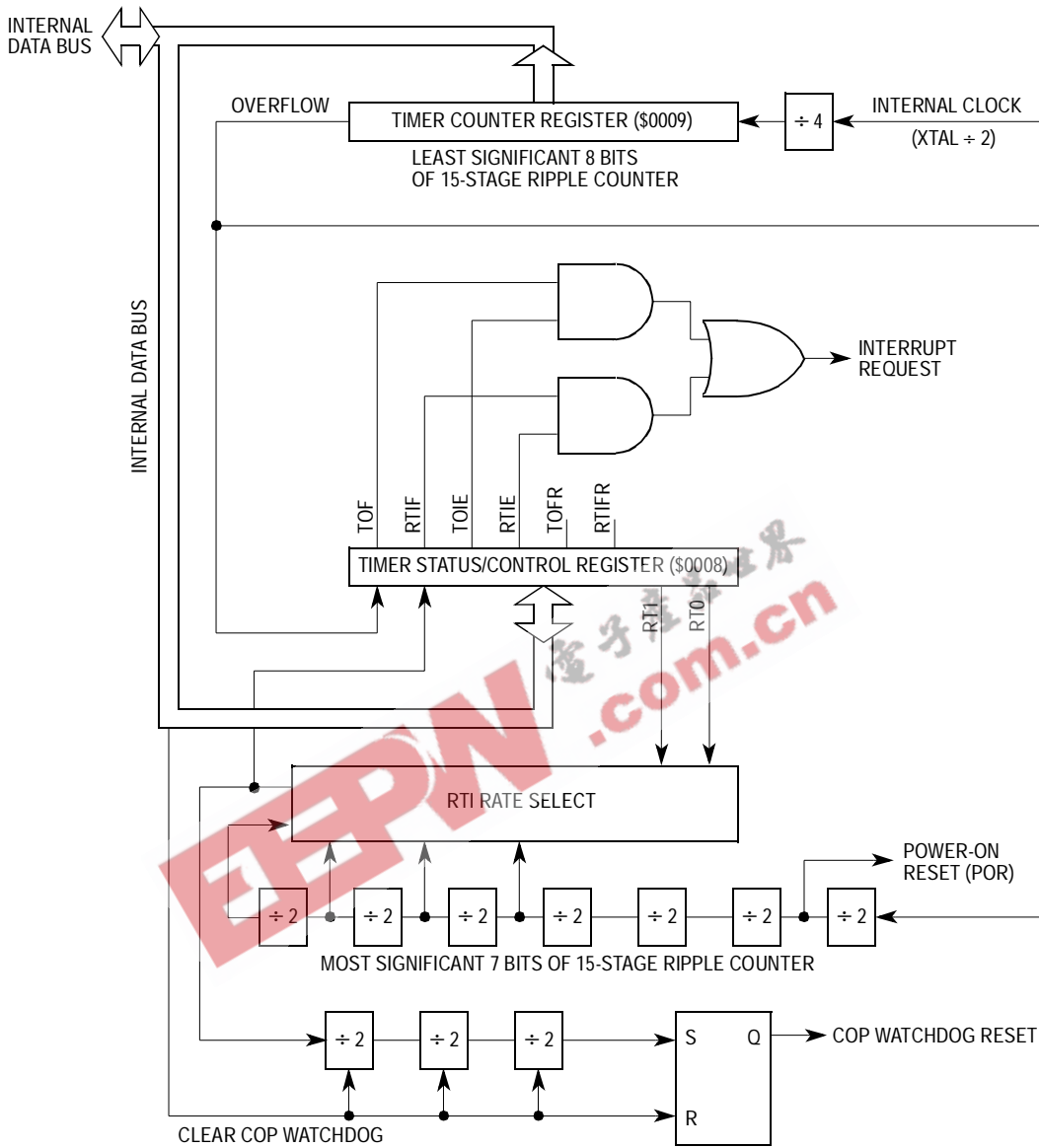

Figure 8-1. Multifunction Timer Block Diagram

8.3 Timer Status and Control Register

The read/write timer status and control register (TSCR) contains these bits:

- Timer interrupt enable bits
- Timer interrupt flags
- Timer interrupt flag reset bits
- Timer interrupt rate select bits

Address: \$0008

	Bit 7	6	5	4	3	2	1	Bit 0
Read:	TOF	RTIF	TOIE	RTIE	0	0	RT1	RT0
Write:					TOFR	RTIFR		
Reset:	0	0	0	0	0	0	1	1

 = Unimplemented

Figure 8-2. Timer Status and Control Register (TSCR)

TOF — Timer Overflow Flag

This read-only flag becomes set when the first eight stages of the counter roll over from \$FF to \$00. TOF generates a timer overflow interrupt request if TOIE is also set. Clear TOF by writing a logic 1 to the TOFR bit. Writing to TOF has no effect. Reset clears TOF.

RTIF — Real-Time Interrupt Flag

This read-only flag becomes set when the selected real-time interrupt (RTI) output becomes active. RTIF generates a real-time interrupt request if RTIE is also set. Clear RTIF by writing a logic 1 to the RTIFR bit. Writing to RTIF has no effect. Reset clears RTIF.

TOIE — Timer Overflow Interrupt Enable Bit

This read/write bit enables timer overflow interrupts.

- 1 = Timer overflow interrupts enabled
- 0 = Timer overflow interrupts disabled

RTIE — Real-Time Interrupt Enable Bit

This read/write bit enables real-time interrupts.

1 = Real-time interrupts enabled

0 = Real-time interrupts disabled

TOFR — Timer Overflow Flag Reset Bit

Writing a logic 1 to this write-only bit clears the TOF bit. TOFR always reads as logic 0. Reset clears TOFR.

RTIFR — Real-Time Interrupt Flag Reset Bit

Writing a logic 1 to this write-only bit clears the RTIF bit. RTIFR always reads as logic 0. Reset clears RTIFR.

RT1 and RT0 — Real-Time Interrupt Select Bits 1 and 0

These read/write bits select one of four RTI rates, as shown in [Table 8-1](#). Because the selected RTI output drives the COP watchdog, changing the real-time interrupt rate also changes the counting rate of the COP watchdog. Reset sets RT1 and RT0.

NOTE: *Changing RT1 and RT0 when a COP timeout is imminent or uncertain may cause a real-time interrupt request to be missed or an additional real-time interrupt request to be generated. Clear the COP timer just before changing RT1 and RT0.*

Table 8-1. Real-Time Interrupt Rate Selection

RT1:RT0	Number of Cycles to RTI	RTI Period ⁽¹⁾	Number of Cycles to COP Reset	COP Timeout Period ⁽¹⁾
0 0	$2^{14} = 16,384$	8.2 ms	$2^{17} = 131,072$	65.5 ms
0 1	$2^{15} = 32,768$	16.4 ms	$2^{18} = 262,144$	131.1 ms
1 0	$2^{16} = 65,536$	32.8 ms	$2^{19} = 524,288$	262.1 ms
1 1	$2^{17} = 131,072$	65.5 ms	$2^{20} = 1,048,576$	524.3 ms

1. At 2-MHz bus, 4-MHz XTAL, 0.5 μ s per cycle

A 15-stage ripple counter is the core of the timer. The value of the first eight stages is readable at any time from the read-only timer counter register (TCNTR).

Address: \$0009

	Bit 7	6	5	4	3	2	1	Bit 0
Read:	Bit 7	Bit 6	Bit 5	Bit 4	Bit 3	Bit 2	Bit 1	Bit 0
Write:								
Reset:	0	0	0	0	0	0	0	0

 = Unimplemented

Figure 8-3. Timer Counter Register (TCNTR)

Power-on clears the entire counter chain and begins clocking the counter. After 4064 cycles, the power-on reset circuit is released, clearing the counter again and allowing the MCU to come out of reset.

A timer overflow function at the eighth counter stage allows a timer interrupt every 1024 internal clock cycles.

8.4 COP Watchdog

Four counter stages at the end of the timer make up the mask-optional computer operating properly (COP) watchdog. (See [Figure 8-4](#).)

The COP watchdog is a software error detection system that automatically times out and resets the MCU if not cleared periodically by a program sequence. Writing a logic 0 to bit 0 of the COP register clears the COP watchdog and prevents a COP reset.

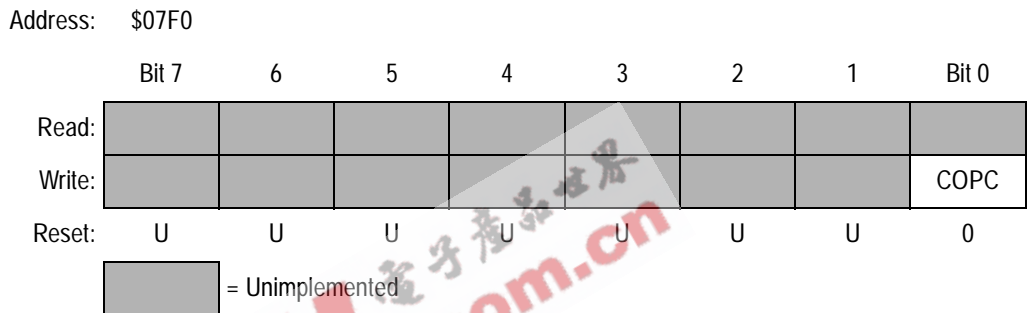

Figure 8-4. COP Register (COPR)

COPC — COP Clear Bit

This write-only bit resets the COP watchdog. Reading address \$07F0 returns the ROM data at that address.

NOTE: *The STOP instruction turns off the COP watchdog. In applications that depend on the COP watchdog, the STOP instruction can be disabled by a mask option.*

Section 9. Instruction Set

9.1 Contents

9.2	Introduction	78
9.3	Addressing Modes	78
9.3.1	Inherent	79
9.3.2	Immediate	79
9.3.3	Direct	79
9.3.4	Extended	79
9.3.5	Indexed, No Offset	80
9.3.6	Indexed, 8-Bit Offset	80
9.3.7	Indexed, 16-Bit Offset	80
9.3.8	Relative	81
9.4	Instruction Types	81
9.4.1	Register/Memory Instructions	82
9.4.2	Read-Modify-Write Instructions	83
9.4.3	Jump/Branch Instructions	84
9.4.4	Bit Manipulation Instructions	86
9.4.5	Control Instructions	87
9.5	Instruction Set Summary	88
9.6	Opcode Map	93

9.2 Introduction

The microcontroller unit (MCU) instruction set has 62 instructions and uses eight addressing modes. The instructions include all those of the M146805 CMOS Family plus one more: the unsigned multiply (MUL) instruction. The MUL instruction allows unsigned multiplication of the contents of the accumulator (A) and the index register (X). The high-order product is stored in the index register, and the low-order product is stored in the accumulator.

9.3 Addressing Modes

The central processor unit (CPU) uses eight addressing modes for flexibility in accessing data. The addressing modes provide eight different ways for the CPU to find the data required to execute an instruction.

The eight addressing modes are:

- Inherent
- Immediate
- Direct
- Extended
- Indexed, no offset
- Indexed, 8-bit offset
- Indexed, 16-bit offset
- Relative

9.3.1 Inherent

Inherent instructions are those that have no operand, such as return from interrupt (RTI) and stop (STOP). Some of the inherent instructions act on data in the CPU registers, such as set carry flag (SEC) and increment accumulator (INCA). Inherent instructions require no operand address and are one byte long.

9.3.2 Immediate

Immediate instructions are those that contain a value to be used in an operation with the value in the accumulator or index register. Immediate instructions require no operand address and are two bytes long. The opcode is the first byte, and the immediate data value is the second byte.

9.3.3 Direct

Direct instructions can access any of the first 256 memory locations with two bytes. The first byte is the opcode, and the second is the low byte of the operand address. In direct addressing, the CPU automatically uses \$00 as the high byte of the operand address.

9.3.4 Extended

Extended instructions use three bytes and can access any address in memory. The first byte is the opcode; the second and third bytes are the high and low bytes of the operand address.

When using the Motorola assembler, the programmer does not need to specify whether an instruction is direct or extended. The assembler automatically selects the shortest form of the instruction.

9.3.5 Indexed, No Offset

Indexed instructions with no offset are 1-byte instructions that can access data with variable addresses within the first 256 memory locations. The index register contains the low byte of the effective address of the operand. The CPU automatically uses \$00 as the high byte, so these instructions can address locations \$0000–\$00FF.

Indexed, no offset instructions are often used to move a pointer through a table or to hold the address of a frequently used RAM or I/O location.

9.3.6 Indexed, 8-Bit Offset

Indexed, 8-bit offset instructions are 2-byte instructions that can access data with variable addresses within the first 511 memory locations. The CPU adds the unsigned byte in the index register to the unsigned byte following the opcode. The sum is the effective address of the operand. These instructions can access locations \$0000–\$01FE.

Indexed 8-bit offset instructions are useful for selecting the *k*th element in an *n*-element table. The table can begin anywhere within the first 256 memory locations and could extend as far as location 510 (\$01FE). The *k* value is typically in the index register, and the address of the beginning of the table is in the byte following the opcode.

9.3.7 Indexed, 16-Bit Offset

Indexed, 16-bit offset instructions are 3-byte instructions that can access data with variable addresses at any location in memory. The CPU adds the unsigned byte in the index register to the two unsigned bytes following the opcode. The sum is the effective address of the operand. The first byte after the opcode is the high byte of the 16-bit offset; the second byte is the low byte of the offset.

Indexed, 16-bit offset instructions are useful for selecting the *k*th element in an *n*-element table anywhere in memory.

As with direct and extended addressing, the Motorola assembler determines the shortest form of indexed addressing.

9.3.8 Relative

Relative addressing is only for branch instructions. If the branch condition is true, the CPU finds the effective branch destination by adding the signed byte following the opcode to the contents of the program counter. If the branch condition is not true, the CPU goes to the next instruction. The offset is a signed, two's complement byte that gives a branching range of -128 to $+127$ bytes from the address of the next location after the branch instruction.

When using the Motorola assembler, the programmer does not need to calculate the offset, because the assembler determines the proper offset and verifies that it is within the span of the branch.

9.4 Instruction Types

The MCU instructions fall into five categories:

- Register/memory instructions
- Read-modify-write instructions
- Jump/branch instructions
- Bit manipulation instructions
- Control instructions

9.4.1 Register/Memory Instructions

These instructions operate on CPU registers and memory locations. Most of them use two operands. One operand is in either the accumulator or the index register. The CPU finds the other operand in memory.

Table 9-1. Register/Memory Instructions

Instruction	Mnemonic
Add memory byte and carry bit to accumulator	ADC
Add memory byte to accumulator	ADD
AND memory byte with accumulator	AND
Bit test accumulator	BIT
Compare accumulator	CMP
Compare index register with memory byte	CPX
Exclusive OR accumulator with memory byte	EOR
Load accumulator with memory byte	LDA
Load Index register with memory byte	LDX
Multiply	MUL
OR accumulator with memory byte	ORA
Subtract memory byte and carry bit from accumulator	SBC
Store accumulator in memory	STA
Store index register in memory	STX
Subtract memory byte from accumulator	SUB

9.4.2 Read-Modify-Write Instructions

These instructions read a memory location or a register, modify its contents, and write the modified value back to the memory location or to the register.

NOTE: Do not use read-modify-write operations on write-only registers.

Table 9-2. Read-Modify-Write Instructions

Instruction	Mnemonic
Arithmetic shift left (same as LSL)	ASL
Arithmetic shift right	ASR
Bit clear	BCLR ⁽¹⁾
Bit set	BSET ⁽¹⁾
Clear register	CLR
Complement (one's complement)	COM
Decrement	DEC
Increment	INC
Logical shift left (same as ASL)	LSL
Logical shift right	LSR
Negate (two's complement)	NEG
Rotate left through carry bit	ROL
Rotate right through carry bit	ROR
Test for negative or zero	TST ⁽²⁾

1. Unlike other read-modify-write instructions, BCLR and BSET use only direct addressing.
2. TST is an exception to the read-modify-write sequence because it does not write a replacement value.

9.4.3 Jump/Branch Instructions

Jump instructions allow the CPU to interrupt the normal sequence of the program counter. The unconditional jump instruction (JMP) and the jump-to-subroutine instruction (JSR) have no register operand. Branch instructions allow the CPU to interrupt the normal sequence of the program counter when a test condition is met. If the test condition is not met, the branch is not performed.

The BRCLR and BRSET instructions cause a branch based on the state of any readable bit in the first 256 memory locations. These 3-byte instructions use a combination of direct addressing and relative addressing. The direct address of the byte to be tested is in the byte following the opcode. The third byte is the signed offset byte. The CPU finds the effective branch destination by adding the third byte to the program counter if the specified bit tests true. The bit to be tested and its condition (set or clear) is part of the opcode. The span of branching is from -128 to $+127$ from the address of the next location after the branch instruction. The CPU also transfers the tested bit to the carry/borrow bit of the condition code register.

Table 9-3. Jump and Branch Instructions

Instruction	Mnemonic
Branch if carry bit clear	BCC
Branch if carry bit set	BCS
Branch if equal	BEQ
Branch if half-carry bit clear	BHCC
Branch if half-carry bit set	BHCS
Branch if higher	BHI
Branch if higher or same	BHS
Branch if \overline{IRQ} pin high	BIH
Branch if \overline{IRQ} pin low	BIL
Branch if lower	BLO
Branch if lower or same	BLS
Branch if interrupt mask clear	BMC
Branch if minus	BMI
Branch if interrupt mask set	BMS
Branch if not equal	BNE
Branch if plus	BPL
Branch always	BRA
Branch if bit clear	BRCLR
Branch never	BRN
Branch if bit set	BRSET
Branch to subroutine	BSR
Unconditional jump	JMP
Jump to subroutine	JSR

9.4.4 Bit Manipulation Instructions

The CPU can set or clear any writable bit in the first 256 bytes of memory, which includes I/O registers and on-chip RAM locations. The CPU can also test and branch based on the state of any bit in any of the first 256 memory locations.

Table 9-4. Bit Manipulation Instructions

Instruction	Mnemonic
Bit clear	BCLR
Branch if bit clear	BRCLR
Branch if bit set	BRSET
Bit set	BSET



9.4.5 Control Instructions

These instructions act on CPU registers and control CPU operation during program execution.

Table 9-5. Control Instructions

Instruction	Mnemonic
Clear carry bit	CLC
Clear interrupt mask	CLI
No operation	NOP
Reset stack pointer	RSP
Return from interrupt	RTI
Return from subroutine	RTS
Set carry bit	SEC
Set interrupt mask	SEI
Stop oscillator and enable \overline{IRQ} pin	STOP
Software interrupt	SWI
Transfer accumulator to index register	TAX
Transfer index register to accumulator	TXA
Stop CPU clock and enable interrupts	WAIT

Freescale Semiconductor, Inc.

9.5 Instruction Set Summary

Table 9-6. Instruction Set Summary (Sheet 1 of 6)



Source Form	Operation	Description	Effect on CCR					Address Mode	Opcode	Operand	Cycles
			H	I	N	Z	C				
ADC #opr ADC opr ADC opr ADC opr,X ADC opr,X ADC ,X	Add with Carry	$A \leftarrow (A) + (M) + (C)$	↑	—	↑	↑	↑	IMM DIR EXT IX2 IX1 IX	A9 B9 C9 D9 E9 F9	ii dd hh ll ee ff ff	2 3 4 5 4 3
ADD #opr ADD opr ADD opr ADD opr,X ADD opr,X ADD ,X	Add without Carry	$A \leftarrow (A) + (M)$	↑	—	↑	↑	↑	IMM DIR EXT IX2 IX1 IX	AB BB CB DB EB FB	ii dd hh ll ee ff ff	2 3 4 5 4 3
AND #opr AND opr AND opr AND opr,X AND opr,X AND ,X	Logical AND	$A \leftarrow (A) \wedge (M)$	—	—	↑	↑	—	IMM DIR EXT IX2 IX1 IX	A4 B4 C4 D4 E4 F4	ii dd hh ll ee ff ff	2 3 4 5 4 3
ASL opr ASLA ASLX ASL opr,X ASL ,X	Arithmetic Shift Left (Same as LSL)		—	—	↑	↑	↑	DIR INH INH IX1 IX	38 48 58 68 78	dd ff	5 3 3 6 5
ASR opr ASRA ASRX ASR opr,X ASR ,X	Arithmetic Shift Right		—	—	↑	↑	↑	DIR INH INH IX1 IX	37 47 57 67 77	dd ff	5 3 3 6 5
BCC rel	Branch if Carry Bit Clear	$PC \leftarrow (PC) + 2 + rel ? C = 0$	—	—	—	—	—	REL	24	rr	3
BCLR n opr	Clear Bit n	$M_n \leftarrow 0$	—	—	—	—	—	DIR (b0) DIR (b1) DIR (b2) DIR (b3) DIR (b4) DIR (b5) DIR (b6) DIR (b7)	11 13 15 17 19 1B 1D 1F	dd dd dd dd dd dd dd dd	5 5 5 5 5 5 5 5
BCS rel	Branch if Carry Bit Set (Same as BLO)	$PC \leftarrow (PC) + 2 + rel ? C = 1$	—	—	—	—	—	REL	25	rr	3
BEQ rel	Branch if Equal	$PC \leftarrow (PC) + 2 + rel ? Z = 1$	—	—	—	—	—	REL	27	rr	3
BHCC rel	Branch if Half-Carry Bit Clear	$PC \leftarrow (PC) + 2 + rel ? H = 0$	—	—	—	—	—	REL	28	rr	3
BHCS rel	Branch if Half-Carry Bit Set	$PC \leftarrow (PC) + 2 + rel ? H = 1$	—	—	—	—	—	REL	29	rr	3
BHI rel	Branch if Higher	$PC \leftarrow (PC) + 2 + rel ? C \vee Z = 0$	—	—	—	—	—	REL	22	rr	3
BHS rel	Branch if Higher or Same	$PC \leftarrow (PC) + 2 + rel ? C = 0$	—	—	—	—	—	REL	24	rr	3

Table 9-6. Instruction Set Summary (Sheet 2 of 6)

Source Form	Operation	Description	Effect on CCR					Address Mode	Opcode	Operand	Cycles
			H	I	N	Z	C				
BIH <i>rel</i>	Branch if IRQ Pin High	$PC \leftarrow (PC) + 2 + rel ? IRQ = 1$	—	—	—	—	—	REL	2F	rr	3
BIL <i>rel</i>	Branch if IRQ Pin Low	$PC \leftarrow (PC) + 2 + rel ? IRQ = 0$	—	—	—	—	—	REL	2E	rr	3
BIT # <i>opr</i> BIT <i>opr</i> BIT <i>opr</i> BIT <i>opr,X</i> BIT <i>opr,X</i> BIT , <i>X</i>	Bit Test Accumulator with Memory Byte	(A) \wedge (M)	—	—	↑	↑	—	IMM DIR EXT IX2 IX1 IX	A5 B5 C5 D5 E5 F5	ii dd hh ll ee ff ff	2 3 4 5 4 3
BLO <i>rel</i>	Branch if Lower (Same as BCS)	$PC \leftarrow (PC) + 2 + rel ? C = 1$	—	—	—	—	—	REL	25	rr	3
BLS <i>rel</i>	Branch if Lower or Same	$PC \leftarrow (PC) + 2 + rel ? C \vee Z = 1$	—	—	—	—	—	REL	23	rr	3
BMC <i>rel</i>	Branch if Interrupt Mask Clear	$PC \leftarrow (PC) + 2 + rel ? I = 0$	—	—	—	—	—	REL	2C	rr	3
BMI <i>rel</i>	Branch if Minus	$PC \leftarrow (PC) + 2 + rel ? N = 1$	—	—	—	—	—	REL	2B	rr	3
BMS <i>rel</i>	Branch if Interrupt Mask Set	$PC \leftarrow (PC) + 2 + rel ? I = 1$	—	—	—	—	—	REL	2D	rr	3
BNE <i>rel</i>	Branch if Not Equal	$PC \leftarrow (PC) + 2 + rel ? Z = 0$	—	—	—	—	—	REL	26	rr	3
BPL <i>rel</i>	Branch if Plus	$PC \leftarrow (PC) + 2 + rel ? N = 0$	—	—	—	—	—	REL	2A	rr	3
BRA <i>rel</i>	Branch Always	$PC \leftarrow (PC) + 2 + rel ? 1 = 1$	—	—	—	—	—	REL	20	rr	3
BRCLR <i>n opr rel</i>	Branch if Bit n Clear	$PC \leftarrow (PC) + 2 + rel ? Mn = 0$	—	—	—	—	↑	DIR (b0) DIR (b1) DIR (b2) DIR (b3) DIR (b4) DIR (b5) DIR (b6) DIR (b7)	01 03 05 07 09 0B 0D 0F	dd rr dd rr dd rr dd rr dd rr dd rr dd rr dd rr	5 5 5 5 5 5 5 5
BRN <i>rel</i>	Branch Never	$PC \leftarrow (PC) + 2 + rel ? 1 = 0$	—	—	—	—	—	REL	21	rr	3
BRSET <i>n opr rel</i>	Branch if Bit n Set	$PC \leftarrow (PC) + 2 + rel ? Mn = 1$	—	—	—	—	↑	DIR (b0) DIR (b1) DIR (b2) DIR (b3) DIR (b4) DIR (b5) DIR (b6) DIR (b7)	00 02 04 06 08 0A 0C 0E	dd rr dd rr dd rr dd rr dd rr dd rr dd rr dd rr	5 5 5 5 5 5 5 5
BSET <i>n opr</i>	Set Bit n	$Mn \leftarrow 1$	—	—	—	—	—	DIR (b0) DIR (b1) DIR (b2) DIR (b3) DIR (b4) DIR (b5) DIR (b6) DIR (b7)	10 12 14 16 18 1A 1C 1E	dd dd dd dd dd dd dd dd	5 5 5 5 5 5 5 5
BSR <i>rel</i>	Branch to Subroutine	$PC \leftarrow (PC) + 2$; push (PCL) $SP \leftarrow (SP) - 1$; push (PCH) $SP \leftarrow (SP) - 1$ $PC \leftarrow (PC) + rel$	—	—	—	—	—	REL	AD	rr	6
CLC	Clear Carry Bit	$C \leftarrow 0$	—	—	—	—	0	INH	98		2
CLI	Clear Interrupt Mask	$I \leftarrow 0$	—	0	—	—	—	INH	9A		2

Freescale Semiconductor, Inc.

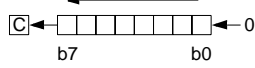
Table 9-6. Instruction Set Summary (Sheet 3 of 6)

Source Form	Operation	Description	Effect on CCR					Address Mode	Opcode	Operand	Cycles
			H	I	N	Z	C				
CLR <i>opr</i> CLRA CLR X CLR <i>opr</i> ,X CLR ,X	Clear Byte	M ← \$00 A ← \$00 X ← \$00 M ← \$00 M ← \$00	—	—	0	1	—	DIR INH INH IX1 IX	3F 4F 5F 6F 7F	dd ff	5 3 3 6 5
CMP # <i>opr</i> CMP <i>opr</i> CMP <i>opr</i> CMP <i>opr</i> ,X CMP <i>opr</i> ,X CMP ,X	Compare Accumulator with Memory Byte	(A) – (M)	—	—	↑	↑	↑	IMM DIR EXT IX2 IX1 IX	A1 B1 C1 D1 E1 F1	ii dd hh ll ee ff ff	2 3 4 5 4 3
COM <i>opr</i> COMA COM X COM <i>opr</i> ,X COM ,X	Complement Byte (One's Complement)	M ← $\overline{(M)} = \$FF - (M)$ A ← $\overline{(A)} = \$FF - (A)$ X ← $\overline{(X)} = \$FF - (X)$ M ← $\overline{(M)} = \$FF - (M)$ M ← $\overline{(M)} = \$FF - (M)$	—	—	↑	↑	1	DIR INH INH IX1 IX	33 43 53 63 73	dd ff	5 3 3 6 5
CPX # <i>opr</i> CPX <i>opr</i> CPX <i>opr</i> CPX <i>opr</i> ,X CPX <i>opr</i> ,X CPX ,X	Compare Index Register with Memory Byte	(X) – (M)	—	—	↑	↑	↑	IMM DIR EXT IX2 IX1 IX	A3 B3 C3 D3 E3 F3	ii dd hh ll ee ff ff	2 3 4 5 4 3
DEC <i>opr</i> DECA DEC X DEC <i>opr</i> ,X DEC ,X	Decrement Byte	M ← (M) – 1 A ← (A) – 1 X ← (X) – 1 M ← (M) – 1 M ← (M) – 1	—	—	↑	↑	—	DIR INH INH IX1 IX	3A 4A 5A 6A 7A	dd ff	5 3 3 6 5
EOR # <i>opr</i> EOR <i>opr</i> EOR <i>opr</i> EOR <i>opr</i> ,X EOR <i>opr</i> ,X EOR ,X	EXCLUSIVE OR Accumulator with Memory Byte	A ← (A) ⊕ (M)	—	—	↑	↑	—	IMM DIR EXT IX2 IX1 IX	A8 B8 C8 D8 E8 F8	ii dd hh ll ee ff ff	2 3 4 5 4 3
INC <i>opr</i> INCA INC X INC <i>opr</i> ,X INC ,X	Increment Byte	M ← (M) + 1 A ← (A) + 1 X ← (X) + 1 M ← (M) + 1 M ← (M) + 1	—	—	↑	↑	—	DIR INH INH IX1 IX	3C 4C 5C 6C 7C	dd ff	5 3 3 6 5
JMP <i>opr</i> JMP <i>opr</i> JMP <i>opr</i> ,X JMP <i>opr</i> ,X JMP ,X	Unconditional Jump	PC ← Jump Address	—	—	—	—	—	DIR EXT IX2 IX1 IX	BC CC DC EC FC	dd hh ll ee ff ff	2 3 4 3 2

Freescale Semiconductor, Inc.

Table 9-6. Instruction Set Summary (Sheet 4 of 6)

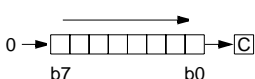
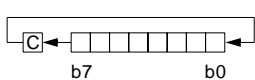
Source Form	Operation	Description	Effect on CCR					Address Mode	Opcode	Operand	Cycles
			H	I	N	Z	C				
JSR <i>opr</i> JSR <i>opr</i> JSR <i>opr,X</i> JSR <i>opr,X</i> JSR ,X	Jump to Subroutine	PC ← (PC) + n (n = 1, 2, or 3) Push (PCL); SP ← (SP) - 1 Push (PCH); SP ← (SP) - 1 PC ← Effective Address	—	—	—	—	—	DIR EXT IX2 IX1 IX	BD CD DD ED FD	dd hh ll ee ff ff	5 6 7 6 5
LDA # <i>opr</i> LDA <i>opr</i> LDA <i>opr</i> LDA <i>opr,X</i> LDA <i>opr,X</i> LDA ,X	Load Accumulator with Memory Byte	A ← (M)	—	—	↑	↑	—	IMM DIR EXT IX2 IX1 IX	A6 B6 C6 D6 E6 F6	ii dd hh ll ee ff ff	2 3 4 5 4 3
LDX # <i>opr</i> LDX <i>opr</i> LDX <i>opr</i> LDX <i>opr,X</i> LDX <i>opr,X</i> LDX ,X	Load Index Register with Memory Byte	X ← (M)	—	—	↑	↑	—	IMM DIR EXT IX2 IX1 IX	AE BE CE DE EE FE	ii dd hh ll ee ff ff	2 3 4 5 4 3
LSL <i>opr</i> LSLA LSLX LSL <i>opr,X</i> LSL ,X	Logical Shift Left (Same as ASL)		—	—	↑	↑	↑	DIR INH INH IX1 IX	38 48 58 68 78	dd ff	5 3 3 6 5
LSR <i>opr</i> LSRA LSRX LSR <i>opr,X</i> LSR ,X	Logical Shift Right		—	—	0	↑	↑	DIR INH INH IX1 IX	34 44 54 64 74	dd ff	5 3 3 6 5
MUL	Unsigned Multiply	X : A ← (X) × (A)	0	—	—	—	0	INH	42		1 1
NEG <i>opr</i> NEGA NEGX NEG <i>opr,X</i> NEG ,X	Negate Byte (Two's Complement)	M ← -(M) = \$00 - (M) A ← -(A) = \$00 - (A) X ← -(X) = \$00 - (X) M ← -(M) = \$00 - (M) M ← -(M) = \$00 - (M)	—	—	↑	↑	↑	DIR INH INH IX1 IX	30 40 50 60 70	dd ff	5 3 3 6 5
NOP	No Operation		—	—	—	—	—	INH	9D		2
ORA # <i>opr</i> ORA <i>opr</i> ORA <i>opr</i> ORA <i>opr,X</i> ORA <i>opr,X</i> ORA ,X	Logical OR Accumulator with Memory	A ← (A) ∨ (M)	—	—	↑	↑	—	IMM DIR EXT IX2 IX1 IX	AA BA CA DA EA FA	ii dd hh ll ee ff ff	2 3 4 5 4 3
ROL <i>opr</i> ROLA ROLX ROL <i>opr,X</i> ROL ,X	Rotate Byte Left through Carry Bit		—	—	↑	↑	↑	DIR INH INH IX1 IX	39 49 59 69 79	dd ff	5 3 3 6 5

Freescale Semiconductor, Inc.

Instruction Set

Table 9-6. Instruction Set Summary (Sheet 5 of 6)

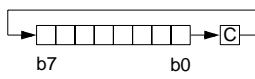
Source Form	Operation	Description	Effect on CCR					Address Mode	Opcode	Operand	Cycles
			H	I	N	Z	C				
ROR <i>opr</i> RORA RORX ROR <i>opr,X</i> ROR ,X	Rotate Byte Right through Carry Bit		—	—	↑	↑	↑	DIR INH INH IX1 IX	36 46 56 66 76	dd ff	5 3 3 6 5
RSP	Reset Stack Pointer	SP ← \$00FF	—	—	—	—	—	INH	9C		2
RTI	Return from Interrupt	SP ← (SP) + 1; Pull (CCR) SP ← (SP) + 1; Pull (A) SP ← (SP) + 1; Pull (X) SP ← (SP) + 1; Pull (PCH) SP ← (SP) + 1; Pull (PCL)	↑	↑	↑	↑	↑	INH	80		9
RTS	Return from Subroutine	SP ← (SP) + 1; Pull (PCH) SP ← (SP) + 1; Pull (PCL)	—	—	—	—	—	INH	81		6
SBC # <i>opr</i> SBC <i>opr</i> SBC <i>opr</i> SBC <i>opr,X</i> SBC <i>opr,X</i> SBC ,X	Subtract Memory Byte and Carry Bit from Accumulator	A ← (A) - (M) - (C)	—	—	↑	↑	↑	IMM DIR EXT IX2 IX1 IX	A2 B2 C2 D2 E2 F2	ii dd hh ll ee ff ff	2 3 4 5 4 3
SEC	Set Carry Bit	C ← 1	—	—	—	—	1	INH	99		2
SEI	Set Interrupt Mask	I ← 1	—	1	—	—	—	INH	9B		2
STA <i>opr</i> STA <i>opr</i> STA <i>opr,X</i> STA <i>opr,X</i> STA ,X	Store Accumulator in Memory	M ← (A)	—	—	↑	↑	—	DIR EXT IX2 IX1 IX	B7 C7 D7 E7 F7	dd hh ll ee ff ff	4 5 6 5 4
STOP	Stop Oscillator and Enable IRQ Pin		—	0	—	—	—	INH	8E		2
STX <i>opr</i> STX <i>opr</i> STX <i>opr,X</i> STX <i>opr,X</i> STX ,X	Store Index Register In Memory	M ← (X)	—	—	↑	↑	—	DIR EXT IX2 IX1 IX	BF CF DF EF FF	dd hh ll ee ff ff	4 5 6 5 4
SUB # <i>opr</i> SUB <i>opr</i> SUB <i>opr</i> SUB <i>opr,X</i> SUB <i>opr,X</i> SUB ,X	Subtract Memory Byte from Accumulator	A ← (A) - (M)	—	—	↑	↑	↑	IMM DIR EXT IX2 IX1 IX	A0 B0 C0 D0 E0 F0	ii dd hh ll ee ff ff	2 3 4 5 4 3
SWI	Software Interrupt	PC ← (PC) + 1; Push (PCL) SP ← (SP) - 1; Push (PCH) SP ← (SP) - 1; Push (X) SP ← (SP) - 1; Push (A) SP ← (SP) - 1; Push (CCR) SP ← (SP) - 1; I ← 1 PCH ← Interrupt Vector High Byte PCL ← Interrupt Vector Low Byte	—	1	—	—	—	INH	83		1 0
TAX	Transfer Accumulator to Index Register	X ← (A)	—	—	—	—	—	INH	97		2

Freescale Semiconductor, Inc.

Table 9-6. Instruction Set Summary (Sheet 6 of 6)

Source Form	Operation	Description	Effect on CCR					Address Mode	Opcode	Operand	Cycles
			H	I	N	Z	C				
TST <i>opr</i> TSTA TSTX TST <i>opr,X</i> TST <i>,X</i>	Test Memory Byte for Negative or Zero	(M) – \$00	—	—	↑	↑	—	DIR INH INH IX1 IX	3D 4D 5D 6D 7D	dd ff	4 3 3 5 4
TXA	Transfer Index Register to Accumulator	A ← (X)	—	—	—	—	—	INH	9F		2
WAIT	Stop CPU Clock and Enable Interrupts		—	0	—	—	—	INH	8F		2

- | | | | |
|-------|---|------------|--------------------------------------|
| A | Accumulator | <i>opr</i> | Operand (one or two bytes) |
| C | Carry/borrow flag | PC | Program counter |
| CCR | Condition code register | PCH | Program counter high byte |
| dd | Direct address of operand | PCL | Program counter low byte |
| dd rr | Direct address of operand and relative offset of branch instruction | REL | Relative addressing mode |
| DIR | Direct addressing mode | <i>rel</i> | Relative program counter offset byte |
| ee ff | High and low bytes of offset in indexed, 16-bit offset addressing | rr | Relative program counter offset byte |
| EXT | Extended addressing mode | SP | Stack pointer |
| ff | Offset byte in indexed, 8-bit offset addressing | X | Index register |
| H | Half-carry flag | Z | Zero flag |
| hh ll | High and low bytes of operand address in extended addressing | # | Immediate value |
| I | Interrupt mask | ^ | Logical AND |
| ii | Immediate operand byte | ∨ | Logical OR |
| IMM | Immediate addressing mode | ⊕ | Logical EXCLUSIVE OR |
| INH | Inherent addressing mode | () | Contents of |
| IX | Indexed, no offset addressing mode | -() | Negation (two's complement) |
| IX1 | Indexed, 8-bit offset addressing mode | ← | Loaded with |
| IX2 | Indexed, 16-bit offset addressing mode | ? | If |
| M | Memory location | : | Concatenated with |
| N | Negative flag | ‡ | Set or cleared |
| n | Any bit | — | Not affected |

9.6 Opcode Map

See [Table 9-7](#).

Instruction Set

Table 9-7. Opcode Map

MSB LSB	Bit Manipulation			Read-Modify-Write				Control			Register/Memory						MSB LSB
	DIR	DIR	REL	DIR	INH	INH	INH	IX1	IX	INH	INH	IMM	DIR	EXT	IX2	IX1	
0	BRSET0 3 DIR2	BSET0 5 DIR2	BRA 3 REL2	NEG 5 DIR1	NEGA 3 INH1	NEGX 3 INH2	NEG 5 IX1	RTI 9 INH	7	8	9	A	B	C	D	E	F
1	BRCLR0 3 DIR2	BCLR0 5 DIR2	BRN 3 REL2					RTS 6 INH				CMP 2 IMM2	CMP 3 DIR3	CMP 4 EXT3	CMP 5 IX2	CMP 4 IX1	CMP 3 IX
2	BRSET1 3 DIR2	BSET1 5 DIR2	BHI 3 REL2	MUL 1 INH								SBC 2 IMM2	SBC 3 DIR3	SBC 4 EXT3	SBC 5 IX2	SBC 4 IX1	SBC 3 IX
3	BRCLR1 3 DIR2	BCLR1 5 DIR2	BLS 3 REL2	COMA 5 DIR1	COMX 3 INH1	COM 3 INH2	COM 6 IX1	SWI 10 INH				CPX 2 IMM2	CPX 3 DIR3	CPX 4 EXT3	CPX 5 IX2	CPX 4 IX1	CPX 3 IX
4	BRSET2 3 DIR2	BSET2 5 DIR2	BCC 3 REL2	LSR 5 DIR1	LSRA 3 INH1	LSRX 3 INH2	LSR 6 IX1					AND 2 IMM2	AND 3 DIR3	AND 4 EXT3	AND 5 IX2	AND 4 IX1	AND 3 IX
5	BRCLR2 3 DIR2	BCLR2 5 DIR2	BCS/BLO 3 REL2									BIT 2 IMM2	BIT 3 DIR3	BIT 4 EXT3	BIT 5 IX2	BIT 4 IX1	BIT 3 IX
6	BRSET3 3 DIR2	BSET3 5 DIR2	BNE 3 REL2	ROR 5 DIR1	RORA 3 INH1	RORX 3 INH2	ROR 6 IX1					LDA 2 IMM2	LDA 3 DIR3	LDA 4 EXT3	LDA 5 IX2	LDA 4 IX1	LDA 3 IX
7	BRCLR3 3 DIR2	BCLR3 5 DIR2	BEQ 3 REL2	ASR 5 DIR1	ASRA 3 INH1	ASRX 3 INH2	ASR 6 IX1	TAX 1 INH				STA 2 IMM2	STA 3 DIR3	STA 4 EXT3	STA 5 IX2	STA 4 IX1	STA 3 IX
8	BRSET4 3 DIR2	BSET4 5 DIR2	BHCC 3 REL2	ASL/LSL 5 DIR1	ASLA/LSLA 3 INH1	ASL/LSL 3 INH2	ASL/LSL 6 IX1	CLC 1 INH				EOR 2 IMM2	EOR 3 DIR3	EOR 4 EXT3	EOR 5 IX2	EOR 4 IX1	EOR 3 IX
9	BRCLR4 3 DIR2	BCLR4 5 DIR2	BHCS 3 REL2	ROL 5 DIR1	ROLA 3 INH1	ROXL 3 INH2	ROL 6 IX1	SEC 1 INH				ADC 2 IMM2	ADC 3 DIR3	ADC 4 EXT3	ADC 5 IX2	ADC 4 IX1	ADC 3 IX
A	BRSET5 3 DIR2	BSET5 5 DIR2	BPL 3 REL2	DEC 5 DIR1	DECA 3 INH1	DECX 3 INH2	DEC 6 IX1	CLI 1 INH				ORA 2 IMM2	ORA 3 DIR3	ORA 4 EXT3	ORA 5 IX2	ORA 4 IX1	ORA 3 IX
B	BRCLR5 3 DIR2	BCLR5 5 DIR2	BMI 3 REL2					SEI 1 INH				ADD 2 IMM2	ADD 3 DIR3	ADD 4 EXT3	ADD 5 IX2	ADD 4 IX1	ADD 3 IX
C	BRSET6 3 DIR2	BSET6 5 DIR2	BMC 3 REL2	INC 5 DIR1	INCA 3 INH1	INCX 3 INH2	INC 6 IX1	RSP 1 INH				JMP 2 IMM2	JMP 3 DIR3	JMP 4 EXT3	JMP 5 IX2	JMP 4 IX1	JMP 3 IX
D	BRCLR6 3 DIR2	BCLR6 5 DIR2	BMS 3 REL2	TST 4 DIR1	TSTA 3 INH1	TSTX 3 INH2	TST 5 IX1	NOP 1 INH				BSR 2 IMM2	BSR 3 DIR3	BSR 4 EXT3	BSR 5 IX2	BSR 4 IX1	BSR 3 IX
E	BRSET7 3 DIR2	BSET7 5 DIR2	BIL 3 REL2					STOP 2 INH				LDX 2 IMM2	LDX 3 DIR3	LDX 4 EXT3	LDX 5 IX2	LDX 4 IX1	LDX 3 IX
F	BRCLR7 3 DIR2	BCLR7 5 DIR2	BIH 3 REL2	CLR 5 DIR1	CLRA 3 INH1	CLRXL 3 INH2	CLR 6 IX1	WAIT 2 INH				STX 2 IMM2	STX 3 DIR3	STX 4 EXT3	STX 5 IX2	STX 4 IX1	STX 3 IX

INH = Inherent
IMM = Immediate
DIR = Direct
EXT = Extended

REL = Relative
IX = Indexed, No Offset
IX1 = Indexed, 8-Bit Offset
IX2 = Indexed, 16-Bit Offset

MSB of Opcode in Hexadecimal
0
LSB

MSB of Opcode in Hexadecimal
0
LSB

Number of Cycles
OpCode Mnemonic
Number of Bytes/Addressing Mode

Section 10. Electrical Specifications

10.1 Contents

10.2	Introduction	95
10.3	Maximum Ratings	96
10.4	Operating Temperature Range	97
10.5	Thermal Characteristics	97
10.6	Power Considerations	98
10.7	5.0-Volt DC Electrical Characteristics	99
10.8	3.3-Volt DC Electrical Characteristics	100
10.9	5.0-Volt Control Timing	105
10.10	3.3-Volt Control Timing	106

10.2 Introduction

This section contains electrical and timing specifications.

Electrical Specifications

10.3 Maximum Ratings

Maximum ratings are the extreme limits to which the MCU can be exposed without permanently damaging it.

The MCU contains circuitry to protect the inputs against damage from high static voltages; however, do not apply voltages higher than those shown in the table here. Keep V_{In} and V_{Out} within the range $V_{SS} \leq (V_{In} \text{ or } V_{Out}) \leq V_{DD}$. Connect unused inputs to the appropriate voltage level, either V_{SS} or V_{DD} .

Rating ⁽¹⁾	Symbol	Value	Unit
Supply voltage	V_{DD}	-0.3 to +7.0	V
Input voltage	V_{In}	$V_{SS} - 0.3$ to $V_{DD} + 0.3$	V
Current drain per pin excluding V_{DD} and V_{SS}	I	25	mA
Storage temperature range	T_{STG}	-65 to +150	°C

1. Voltages referenced to V_{SS}

NOTE: *This device is not guaranteed to operate properly at the maximum ratings. Refer to [10.7 5.0-Volt DC Electrical Characteristics](#) and [10.8 3.3-Volt DC Electrical Characteristics](#) for guaranteed operating conditions.*

10.4 Operating Temperature Range

Rating	Symbol	Value	Unit
Operating temperature range MC68HC05J1AP ⁽¹⁾ , DW ⁽²⁾ MC68HC05J1AC ⁽³⁾ P, CDW MC68HC05J1AV ⁽⁴⁾ P MC68HC05J1AVDW	T_A	0 to +70 -40 to +85 -40 to +105 -40 to +105	°C

1. P = Plastic dual in-line package (PDIP)
2. DW = Small outline integrated circuit (SOIC)
3. C = Extended temperature range (-40°C to +85°C)
4. V = Automotive temperature range (-40°C to +105°C)

10.5 Thermal Characteristics

Characteristic	Symbol	Value	Unit
Maximum junction temperature	T_J	150	°C
Thermal resistance MC68HC05J1AP ⁽¹⁾ MC68HC05J1ADW ⁽²⁾	θ_{JA}	68 85	°C/W

1. P = Plastic dual in-line package (PDIP)
2. DW = Small outline integrated circuit (SOIC)

10.6 Power Considerations

The average chip junction temperature, T_J , in °C can be obtained from:

$$T_J = T_A + (P_D \times \theta_{JA}) \quad (1)$$

Where:

T_A = ambient temperature in °C

θ_{JA} = package thermal resistance, junction to ambient in °C/W

$P_D = P_{INT} + P_{I/O}$

$P_{INT} = I_{CC} \times V_{CC}$ = chip internal power dissipation

$P_{I/O}$ = power dissipation on input and output pins (user-determined)

For most applications, $P_{I/O} < P_{INT}$ and can be neglected.

Ignoring $P_{I/O}$, the relationship between P_D and T_J is approximately:

$$P_D = \frac{K}{T_J + 273^\circ\text{C}} \quad (2)$$

Solving equations (1) and (2) for K gives:

$$K = P_D \times (T_A + 273^\circ\text{C}) + \theta_{JA} \times (P_D)^2 \quad (3)$$

where K is a constant pertaining to the particular part. K can be determined from equation (3) by measuring P_D (at equilibrium) for a known T_A . Using this value of K, the values of P_D and T_J can be obtained by solving equations (1) and (2) iteratively for any value of T_A .

10.7 5.0-Volt DC Electrical Characteristics

Characteristic ⁽¹⁾	Symbol	Min	Typ	Max	Unit
Output voltage $I_{Load} = 10.0 \mu A$ $I_{Load} = -10.0 \mu A$	V_{OL} V_{OH}	— $V_{DD} - 0.1$	— —	0.1 —	V
Output high voltage PA7–PA0, PB5–PB0 ($I_{Load} = -0.8 \text{ mA}$)	V_{OH}	$V_{DD} - 0.8$	—	—	V
Output low voltage PA3–PA0, PB5–PB0 ($I_{Load} = 1.6 \text{ mA}$) PA7–PA4 ($I_{Load} = 8.0 \text{ mA}$)	V_{OL}	— —	— —	0.4 0.4	V
Input high voltage PA7–PA0, PB5–PB0, \overline{IRQ} , \overline{RESET} , OSC1	V_{IH}	$0.7 \times V_{DD}$	—	V_{DD}	V
Input low voltage PA7–PA0, PB5–PB0, \overline{IRQ} , \overline{RESET} , OSC1	V_{IL}	V_{SS}	—	$0.2 \times V_{DD}$	V
Supply current Run ⁽²⁾ Wait ⁽³⁾ Stop ⁽⁴⁾ 25°C –40°C to +85°C	I_{DD}	— — — —	3.0 1.6 0.2 2.0	4.0 2.5 10 20	mA mA μA μA
I/O ports hi-z leakage current PA7–PA0, PB5–PB0 (pulldown device off)	I_{IL}	—	—	± 10	μA
Input pulldown current PA7–PA0, PB5–PB0 (pulldown device on)	I_{IL}	50	100	200	μA
Input current \overline{RESET} , \overline{IRQ} , OSC1	I_{In}	—	—	± 1	μA
Capacitance PA7–PA0, PB5–PB0 (input or output) \overline{RESET} , \overline{IRQ} , OSC1, OSC2	C_{Out} C_{In}	— —	— —	12 8	pF
Oscillator internal resistor (Crystal/ceramic resonator mask option)	R_{Osc}	1.0	2.0	3.0	M Ω

- $V_{DD} = 5.0 \text{ Vdc} \pm 10\%$; $V_{SS} = 0 \text{ Vdc}$; $T_A = -40^\circ\text{C}$ to $+85^\circ\text{C}$; values reflect average measurements at midpoint of voltage range at 25°C
- Run (operating) I_{DD} measured using external square wave clock source ($f_{OSC} = 4.2 \text{ MHz}$) with all inputs 0.2 V from rail. No dc loads. Less than 50 pF on all outputs. $C_L = 20 \text{ pF}$ on OSC2.
- Wait I_{DD} measured using external square wave clock source ($f_{OSC} = 4.2 \text{ MHz}$) with all inputs 0.2 V from rail and only the timer active. No dc loads. Less than 50 pF on all outputs. $C_L = 20 \text{ pF}$ on OSC2. All ports configured as inputs. $V_{IL} = 0.2 \text{ V}$. $V_{IH} = V_{DD} - 0.2 \text{ V}$. OSC2 capacitance linearly affects wait I_{DD} .
- Stop I_{DD} measured with $OSC1 = V_{SS}$. All ports configured as inputs. $V_{IL} = 0.2 \text{ V}$. $V_{IH} = V_{DD} - 0.2 \text{ V}$.

Electrical Specifications

10.8 3.3-Volt DC Electrical Characteristics

Characteristic ⁽¹⁾	Symbol	Min	Typ	Max	Unit
Output voltage $I_{Load} \leq 10.0 \mu A$ $I_{Load} \leq -10.0 \mu A$	V_{OL} V_{OH}	— $V_{DD} - 0.1$	— —	0.1 —	V
Output high voltage PA7–PA0, PB5–PB0 ($I_{Load} = -0.2 \text{ mA}$)	V_{OH}	$V_{DD} - 0.3$	—	—	V
Output low voltage PA3–PA0 ($I_{Load} = -0.4 \text{ mA}$) PA7–PA4 ($I_{Load} = 5.0 \text{ mA}$)	V_{OL}	— —	— —	0.3 0.3	V
Input high voltage PA7–PA0, PB5–PB0, \overline{IRQ} , \overline{RESET} , OSC1	V_{IH}	$0.7 \times V_{DD}$	—	V_{DD}	V
Input low voltage PA7–PA0, PB5–PB0, \overline{IRQ} , \overline{RESET} , OSC1	V_{IL}	V_{SS}	—	$0.2 \times V_{DD}$	V
Supply current Run ⁽²⁾ Wait ⁽³⁾ Stop ⁽⁴⁾ 25°C –40°C to +85°C	I_{DD}	— — — —	1.0 0.5 0.1 1	2.0 1.0 5 10	mA mA μA μA
I/O ports hi-z leakage current PA7–PA0, PB5–PB0 (pulldown device off)	I_{IL}	—	—	± 10	μA
Input pulldown current PA7–PA0, PB5–PB0 (pulldown device on)	I_{IL}	20	40	100	μA
Input current \overline{RESET} , \overline{IRQ} , OSC1	I_{In}	—	—	± 1	μA
Capacitance PA7–PA0, PB5–PB0 (input or output) \overline{RESET} , \overline{IRQ} , OSC1, OSC2	C_{Out} C_{In}	— —	— —	12 8	pF
Oscillator internal resistor (Crystal/ceramic resonator mask option)	R_{Osc}	1.0	2.0	3.0	M Ω

- $V_{DD} = 3.3 \text{ Vdc} \pm 10\%$; $V_{SS} = 0 \text{ Vdc}$; $T_A = -40^\circ\text{C}$ to $+85^\circ\text{C}$; values reflect average measurements at midpoint of voltage range at 25°C
- Run (operating) I_{DD} measured using external square wave clock source ($f_{OSC} = 2.0 \text{ MHz}$) with all inputs 0.2 V from rail. No dc loads. Less than 50 pF on all outputs. $C_L = 20 \text{ pF}$ on OSC2.
- Wait I_{DD} measured using external square wave clock source ($f_{OSC} = 2.0 \text{ MHz}$) with all inputs 0.2 V from rail and only the timer active. No dc loads. Less than 50 pF on all outputs. $C_L = 20 \text{ pF}$ on OSC2. All ports configured as inputs. $V_{IL} = 0.2 \text{ V}$. $V_{IH} = V_{DD} - 0.2 \text{ V}$. OSC2 capacitance linearly affects wait I_{DD} .
- Stop I_{DD} measured with $OSC1 = V_{SS}$. All ports configured as inputs. $V_{IL} = 0.2 \text{ V}$. $V_{IH} = V_{DD} - 0.2 \text{ V}$.

Freescale Semiconductor, Inc.

Electrical Specifications
3.3-Volt DC Electrical Characteristics

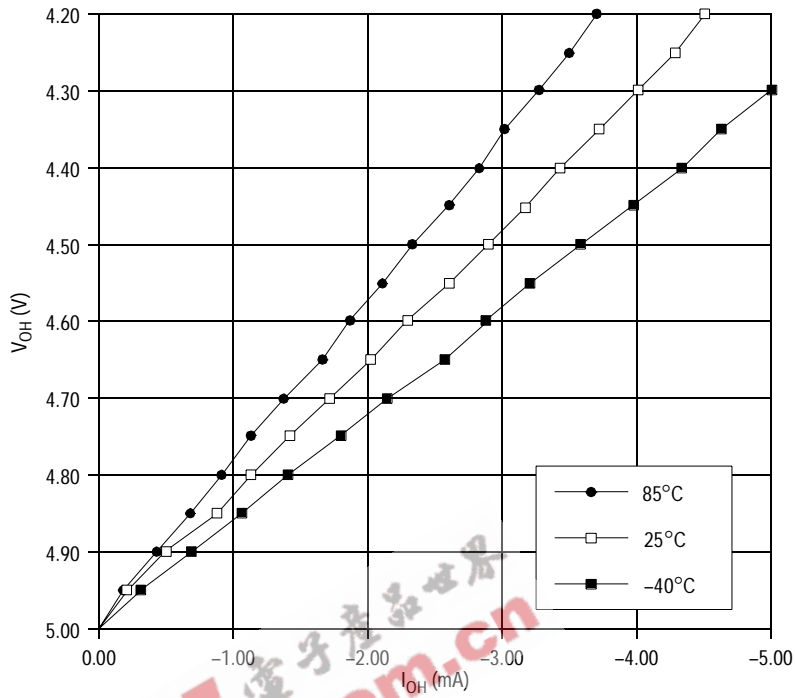

Figure 10-1. Typical V_{OH}/I_{OH} ($V_{DD} = 5.0$ V)

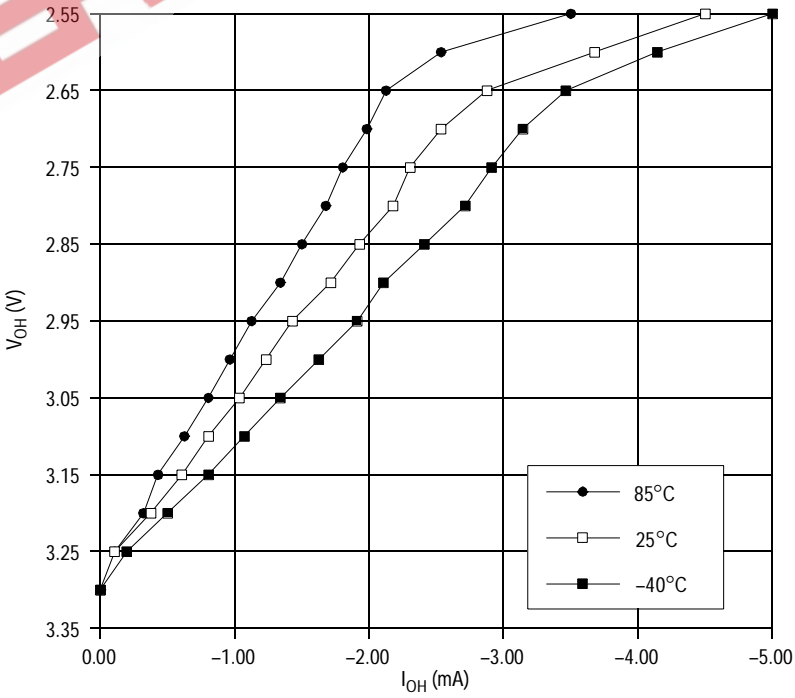

Figure 10-2. Typical V_{OH}/I_{OH} ($V_{DD} = 3.3$ V)

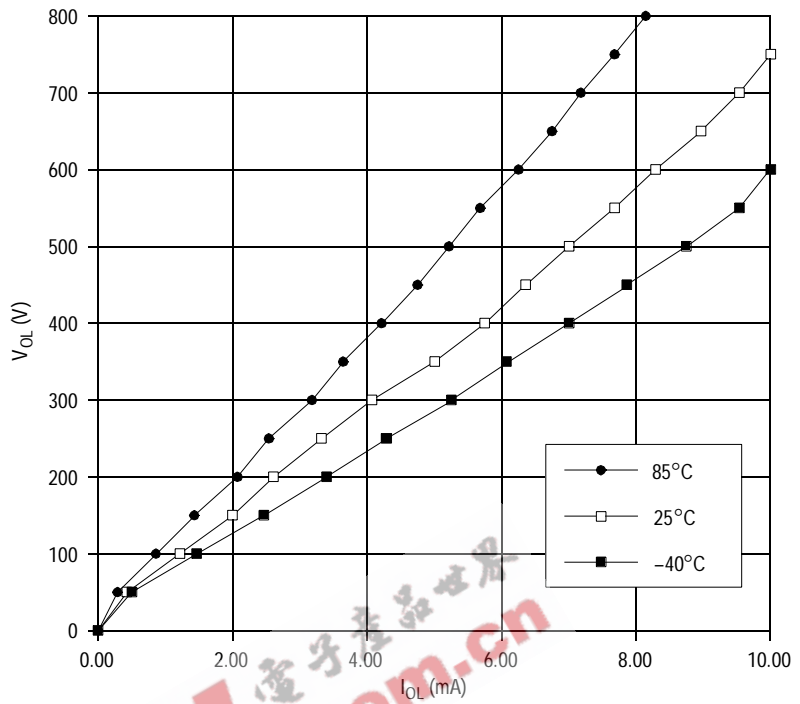

Figure 10-3. Typical V_{OL}/I_{OL} ($V_{DD} = 5.0$ V)

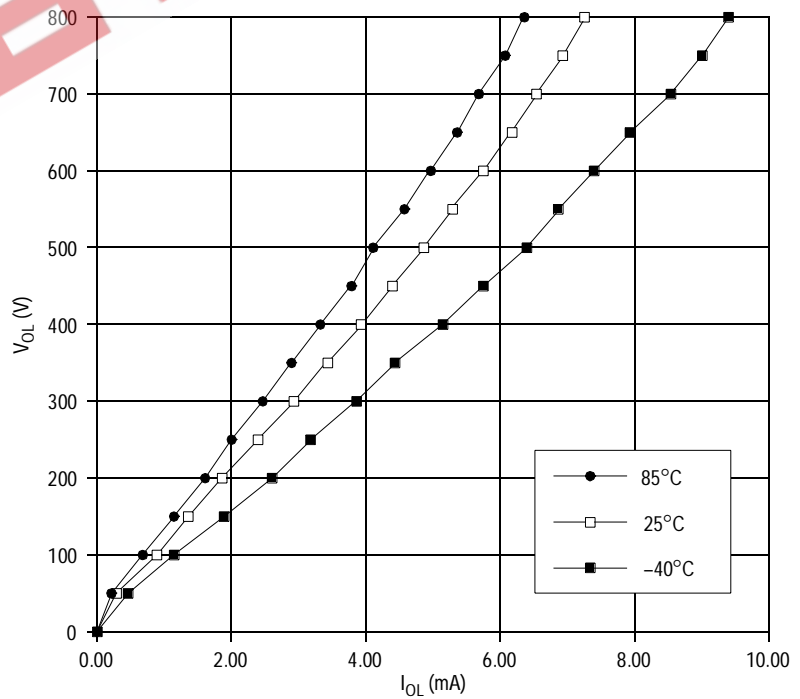

Figure 10-4. Typical V_{OL}/I_{OL} ($V_{DD} = 3.3$ V)

Freescale Semiconductor, Inc.

Electrical Specifications
3.3-Volt DC Electrical Characteristics

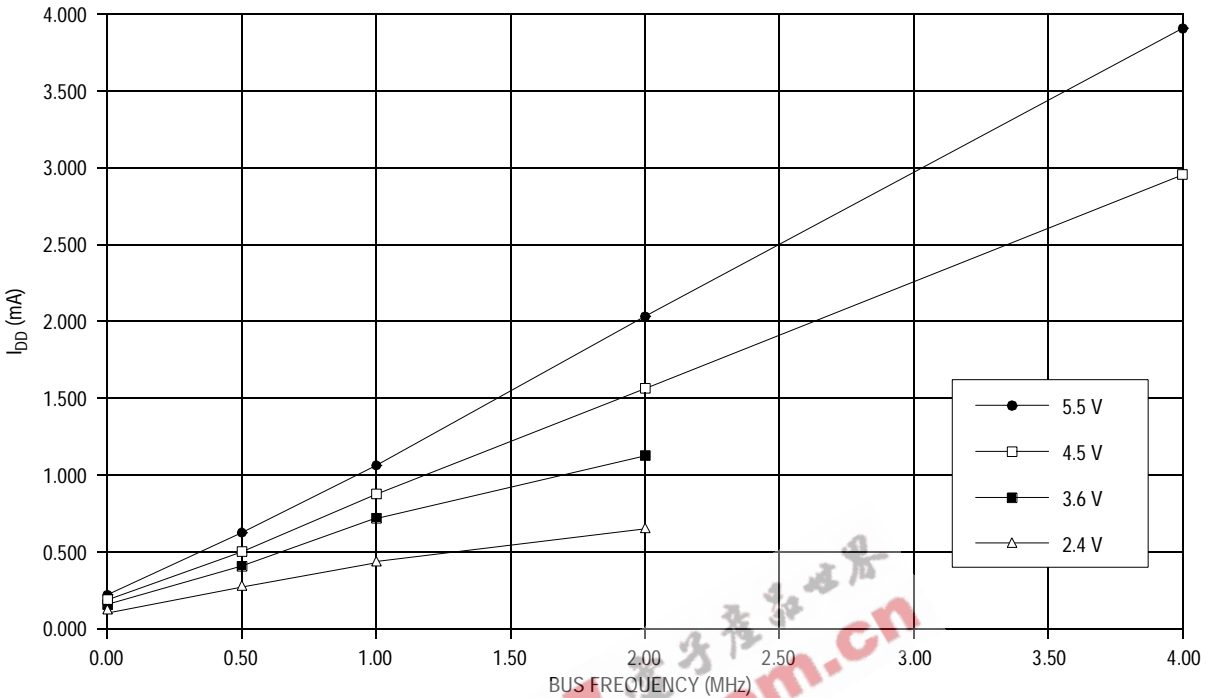

Figure 10-5. Typical Operating I_{DD} (25°C)

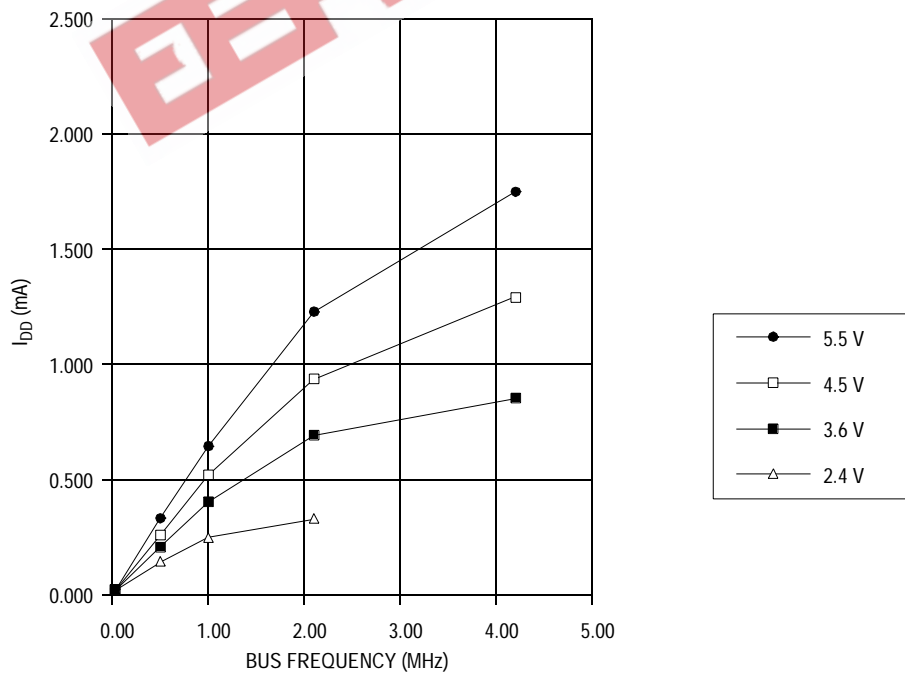

Figure 10-6. Typical Wait Mode I_{DD} (25°C)

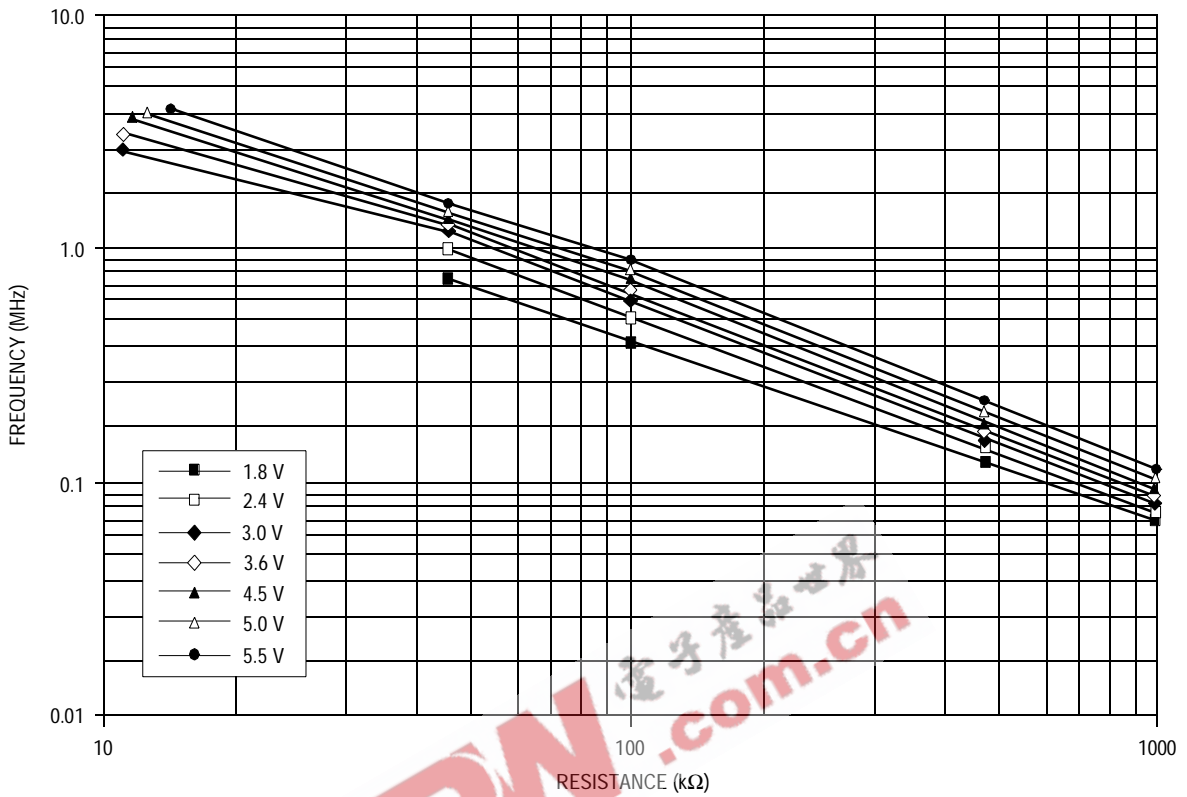

Figure 10-7. Typical Internal Operating Frequency for Various V_{DD} at 25°C — RC Option Only

10.9 5.0-Volt Control Timing

Characteristic ⁽¹⁾	Symbol	Min	Max	Unit
Oscillator frequency Crystal/ceramic resonator mask option ⁽²⁾ RC oscillator mask option External clock mask option	f_{OSC}	— dc —	4.2 4.2 4.2	MHz
Internal operating frequency ($f_{OSC} \div 2$) Crystal oscillator Ceramic resonator RC oscillator External clock	f_{op}	— — dc —	2.1 2.1 2.1 2.1	MHz
Cycle time ($1 \div f_{op}$)	t_{cyc}	476	—	ns
\overline{RESET} pulse width low (edge-triggered)	t_{RL}	1.5	—	t_{cyc}
Timer resolution ⁽³⁾	t_{RESL}	4.0	—	t_{cyc}
\overline{IRQ} interrupt pulse width low (edge-triggered)	t_{ILIH}	125	—	ns
\overline{IRQ} interrupt pulse period	t_{ILIL}	(4)	—	t_{cyc}
PA3–PA0 interrupt pulse width high (edge-triggered)	t_{IHIL}	125	—	ns
PA3–PA0 interrupt pulse period	t_{IHIH}	(4)	—	t_{cyc}
OSC1 pulse width	t_{OH}, t_{OL}	200	—	ns

1. $V_{DD} = 5.0 \text{ Vdc} \pm 10\%$; $V_{SS} = 0 \text{ Vdc}$; $T_A = T_L$ to T_H

2. Use only AT-cut crystals.

3. The 2-bit timer prescaler is the limiting factor in determining timer resolution.

4. The minimum period, t_{ILIL} or t_{IHIH} , should not be less than the number of cycles required to execute the interrupt service routine plus $19 t_{cyc}$.

Electrical Specifications

10.10 3.3-Volt Control Timing

Characteristic ⁽¹⁾	Symbol	Min	Max	Unit
Oscillator frequency Crystal/ceramic resonator mask option ⁽²⁾ RC oscillator mask option External clock mask option	f_{OSC}	— dc —	2.0 2.0 2.0	MHz
Internal operating frequency ($f_{OSC} \div 2$) Crystal oscillator Ceramic resonator RC oscillator External clock	f_{op}	— — dc —	1.0 1.0 1.0 1.0	MHz
Cycle time ($1 \div f_{op}$)	t_{cyc}	1000	—	ns
\overline{RESET} pulse width low (edge-triggered)	t_{RL}	1.5	—	t_{cyc}
Timer resolution ⁽³⁾	t_{RESL}	4.0	—	t_{cyc}
\overline{IRQ} interrupt pulse width low (edge-triggered)	t_{ILIH}	250	—	ns
\overline{IRQ} interrupt pulse period	t_{ILIL}	(4)	—	t_{cyc}
PA3–PA0 interrupt pulse width high (edge-triggered)	t_{IHIL}	250	—	ns
PA3–PA0 interrupt pulse period	t_{HIH}	(4)	—	t_{cyc}
OSC1 pulse width	t_{OH}, t_{OL}	400	—	ns

1. $V_{DD} = 3.3 \text{ Vdc} \pm 10\%$; $V_{SS} = 0 \text{ Vdc}$; $T_A = T_L$ to T_H

2. Use only AT-cut crystals.

3. The 2-bit timer prescaler is the limiting factor in determining timer resolution.

4. The minimum period, t_{ILIL} or t_{HIH} , should not be less than the number of cycles required to execute the interrupt service routine plus $19 t_{cyc}$.

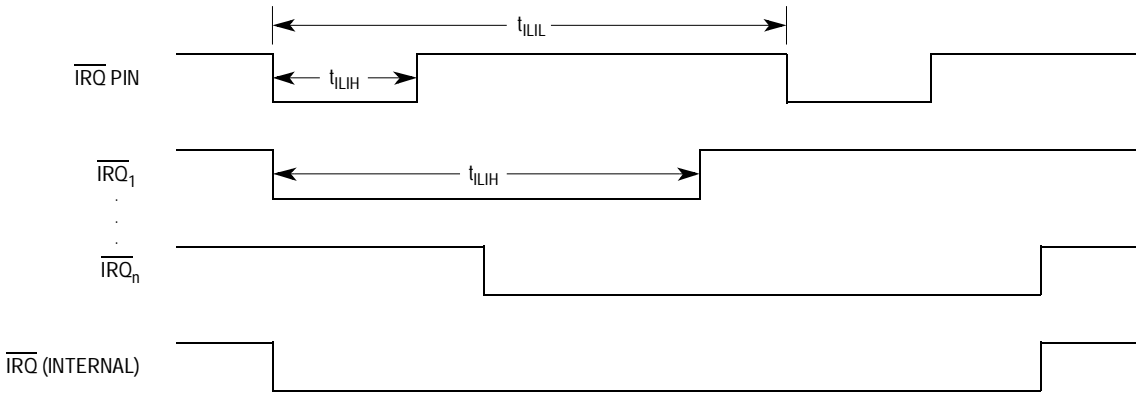
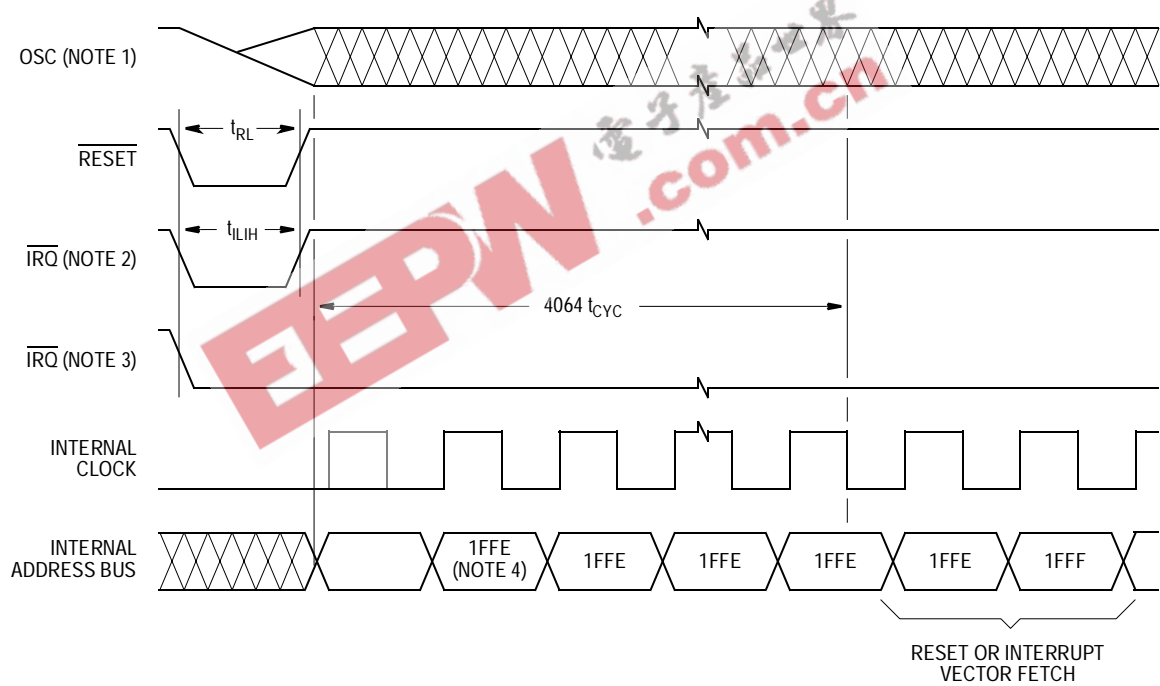

Figure 10-8. External Interrupt Timing



- Notes:
1. Internal clocking from OSC1 pin
 2. Edge-triggered external interrupt mask option
 3. Edge- and level-triggered external interrupt mask option
 4. Reset vector shown as example

Figure 10-9. Stop Mode Recovery Timing

Electrical Specifications

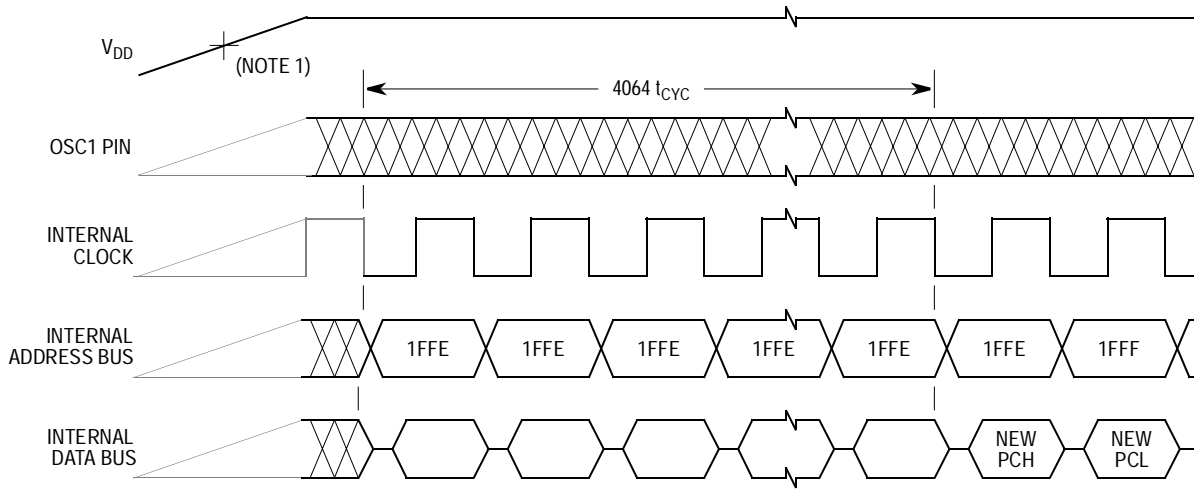

Notes:

1. Power-on reset threshold is typically between 1 V and 2 V.
2. Internal clock, internal address bus, and internal data bus are not available externally.

Figure 10-10. Power-On Reset Timing

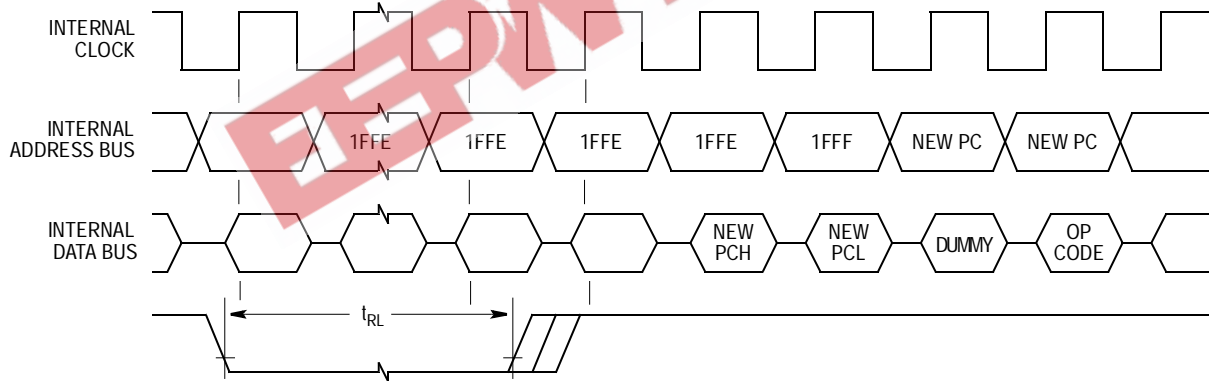

Notes:

1. Internal clock, internal address bus, and internal data bus are not available externally.
2. The next rising edge of the internal clock after the rising edge of RESET initiates the reset sequence.

Figure 10-11. External Reset Timing

Section 11. Mechanical Specifications

11.1 Contents

11.2	Introduction	109
11.3	20-Pin Plastic Dual In-Line Package (PDIP)	110
11.4	20-Pin Small Outline Integrated Circuit Package (SOIC)	110

11.2 Introduction

Package dimensions for the MC68HC05J1A are provided in this section.
The packages are:

- 20-pin plastic dual in-line package (PDIP)
- 20-pin small outline integrated circuit package (SOIC)

Mechanical Specifications

11.3 20-Pin Plastic Dual In-Line Package (PDIP)

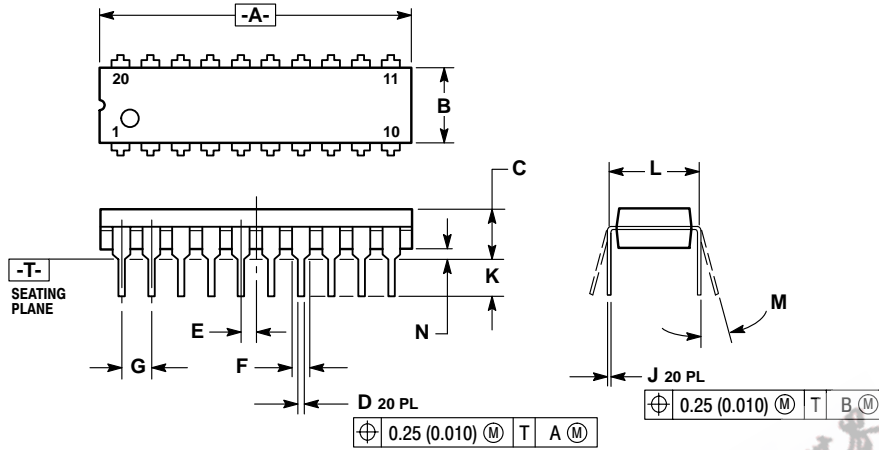

- NOTES:
1. DIMENSIONING AND TOLERANCING PER ANSI Y14.5M, 1982.
 2. CONTROLLING DIMENSION: INCH.
 3. DIMENSION L TO CENTER OF LEAD WHEN FORMED PARALLEL.
 4. DIMENSION B DOES NOT INCLUDE MOLD FLASH.

DIM	INCHES		MILLIMETERS	
	MIN	MAX	MIN	MAX
A	1.010	1.070	25.66	27.17
B	0.240	0.260	6.10	6.60
C	0.150	0.180	3.81	4.57
D	0.015	0.022	0.39	0.55
E	0.050 BSC		1.27 BSC	
F	0.050	0.070	1.27	1.77
G	0.100 BSC		2.54 BSC	
J	0.008	0.015	0.21	0.38
K	0.110	0.140	2.80	3.55
L	0.300 BSC		7.62 BSC	
M	0°	15°	0°	15°
N	0.020	0.040	0.51	1.01

CASE 738-03

11.4 20-Pin Small Outline Integrated Circuit Package (SOIC)

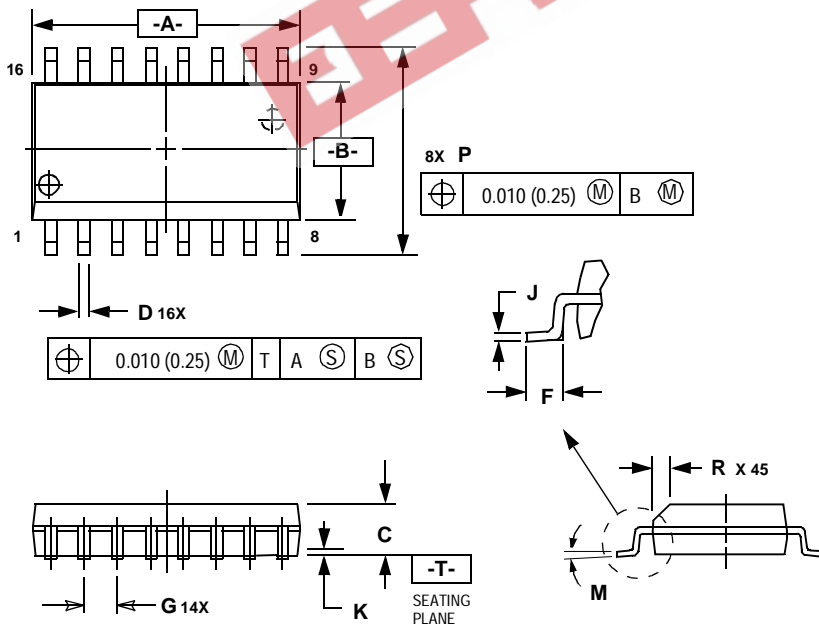

DIM	MILLIMETERS		INCHES	
	MIN	MAX	MIN	MAX
A	10.15	10.45	0.400	0.411
B	7.40	7.60	0.292	0.299
C	2.35	2.65	0.093	0.104
D	0.35	0.49	0.014	0.019
F	0.50	0.90	0.020	0.035
G	1.27 BSC		0.050 BSC	
J	0.25	0.32	0.010	0.012
K	0.10	0.25	0.004	0.009
M	0°	7°	0°	7°
P	10.05	10.55	0.395	0.415
R	0.25	0.75	0.010	0.029

CASE 751

Freescale Semiconductor, Inc.

Section 12. Ordering Information

12.1 Contents

12.2	Introduction	111
12.3	MC Order Numbers	111
12.4	MCU Ordering Forms	112
12.5	Application Program Media	112
12.6	Diskettes	113
12.7	EPROMs	114
12.8	ROM Program Verification	114
12.9	ROM Verification Units (RVUs)	115

12.2 Introduction

This section contains instructions for ordering custom-masked read-only memory (ROM) microcontroller units (MCU).

12.3 MC Order Numbers

Table 12-1. MC Order Numbers

Package Type	Temperature Range	Order Number
20-pin dual in-line package	0°C to 70°C	MC68HC05J1AP
	-40°C to 85°C	MC68HC05J1ACP
	-40°C to 105°C	MC68HC05J1AVP
20-pin small outline integrated circuit (SOIC)	0°C to 70°C	MC68HC05J1ADW
	-40°C to 85°C	MC68HC05J1ACDW
	-40°C to 105°C	MC68HC05J1AVDW

12.4 MCU Ordering Forms

To initiate an order for a ROM-based MCU, first obtain the current ordering form for the MCU from a Motorola representative. Submit these items when ordering MCUs:

- A current MCU ordering form that is **completely filled out** (Contact your Motorola sales office for assistance.)
- A copy of the customer specification if the customer specification deviates from the Motorola specification for the MCU
- Customer's application program on one of the media listed in [12.5 Application Program Media](#)

The current MCU ordering form is also available through the World Wide Web at <http://www.motorola.com/semiconductors/>

12.5 Application Program Media

Deliver the application program to Motorola in one of these media:

- Macintosh®¹ 3 1/2-inch diskette (double-sided double-density 800 Kbytes or double-sided high-density 1.4 Mbytes)
- MS-DOS®² or PC-DOS®³ 3 1/2-inch diskette (double-sided double-density 720 Kbytes or double-sided high-density 1.44 Mbytes)
- MS-DOS® or PC-DOS® 5 1/4-inch diskette (double-sided double-density 360 Kbytes or double-sided high-density 1.2 Mbytes)
- Erasable, programmable read-only memory(s) (EPROM) 2716, 2732, 2764, 27128, 27256, or 27512 (depending on the size of the memory map of the MCU)

Use positive logic for data and addresses.

1. Macintosh is a registered trademark of Apple Computer, Inc.

2. MS-DOS is a registered trademark of Microsoft, Inc.

3. PC-DOS is a registered trademark of International Business Machines Corporation.

12.6 Diskettes

If submitting the application program on a diskette, clearly label the diskette with this information:

- Customer name
- Customer part number
- Project or product name
- Filename of object code
- Date
- Name of operating system that formatted diskette
- Formatted capacity of diskette

On diskettes, the application program must be in Motorola's S-record format (S1 and S9 records), a character-based object file format generated by M6805 cross assemblers and linkers.

NOTE: *Begin the application program at the first user ROM location. Program addresses must correspond exactly to the available on-chip user ROM addresses as shown in the memory map. Write \$00 in all non-user ROM locations or leave all non-user ROM locations blank. See the current MCU ordering form for additional requirements.*

If the memory map has two user ROM areas with the same addresses, then write the two areas in separate files on the diskette. Label the diskette with both filenames.

In addition to the object code, a file containing the source code can be included. Motorola keeps this code confidential and uses it only to expedite ROM pattern generation in case of any difficulty with the object code. Label the diskette with the filename of the source code.

12.7 EPROMs

If submitting the application program in an EPROM, clearly label the EPROM with this information:

- Customer name
- Customer part number
- Checksum
- Project or product name
- Date

NOTE: *Begin the application program at the first user ROM location. Program addresses must correspond exactly to the available on-chip user ROM addresses as shown in the memory map. Write \$00 in all non-user ROM locations. See the current MCU ordering form for additional requirements.*

Submit the application program in one EPROM large enough to contain the entire memory map. If the memory map has two user ROM areas with the same addresses, then write the two areas on separate EPROMs. Label the EPROMs with the addresses they contain.

Pack EPROMs securely in a conductive IC carrier for shipment. Do not use Styrofoam®¹.

12.8 ROM Program Verification

The primary use for the on-chip ROM is to hold the customer's application program. The customer develops and debugs the application program and then submits the MCU order along with the application program.

Motorola inputs the customer's application program code into a computer program that generates a listing verify file. The listing verify file represents the memory map of the MCU. The listing verify file contains the user ROM code and may also contain non-user ROM code, such as self-check code. Motorola sends the customer a computer printout of the listing verify file along with a listing verify form.

¹ Styrofoam is a registered trademark of The Dow Chemical Company.

Freescale Semiconductor, Inc.

Ordering Information
ROM Verification Units (RVUs)

To aid the customer in checking the listing verify file, Motorola will program the listing verify file into customer-supplied blank EPROMs or preformatted Macintosh or DOS disks. All original pattern media are filed for contractual purposes and are not returned.

Check the listing verify file thoroughly, then complete and sign the listing verify form and return the listing verify form to Motorola. The signed listing verify form constitutes the contractual agreement for the creation of the custom mask.

12.9 ROM Verification Units (RVUs)

After receiving the signed listing verify form, Motorola manufactures a custom photographic mask. The mask contains the customer's application program and is used to process silicon wafers. The application program cannot be changed after the manufacture of the mask begins. Motorola then produces ten MCUs, called RVUs, and sends the RVUs to the customer. RVUs are usually packaged in unmarked ceramic and tested to 5 Vdc at room temperature. RVUs are not tested to environmental extremes because their sole purpose is to demonstrate that the customer's user ROM pattern was properly implemented. The ten RVUs are free of charge with the minimum order quantity but are not production parts. RVUs are not guaranteed by Motorola Quality Assurance.



Appendix A. MC68HCL05J1A

A.1 Contents

A.2	Introduction	117
A.3	DC Electrical Characteristics	118
A.4	MC Ordering Information	121

A.2 Introduction

This appendix introduces the MC68HCL05J1A, a low-power version of the MC68HC05J1A. All of the information in this document applies to the MC68HCL05J1A with the exceptions given in this appendix.

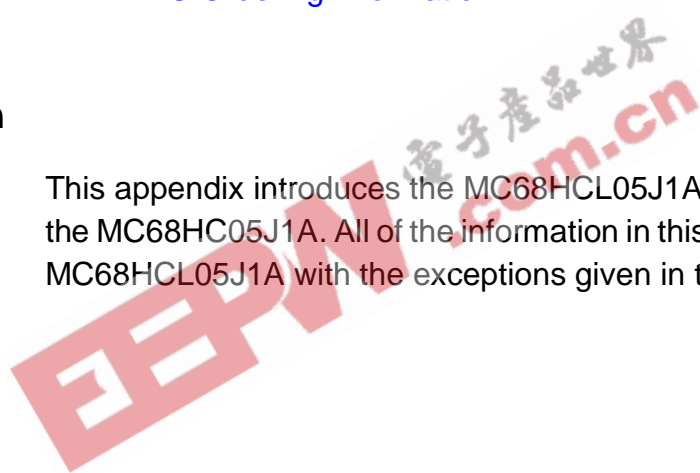

A.3 DC Electrical Characteristics

The data in [10.7 5.0-Volt DC Electrical Characteristics](#) and [10.8 3.3-Volt DC Electrical Characteristics](#) applies to the MC68HCL05J1A with the exceptions shown in [Table A-1](#), [Table A-2](#), [Table A-3](#), and [Table A-4](#).

Table A-1. Low-Power Output Voltage ($V_{DD} = 1.8\text{--}2.4\text{ Vdc}$)

Characteristic	Symbol	Min	Typ	Max	Unit
Output high voltage PA7–PA0, PB5–PB0 ($I_{Load} = -0.1\text{ mA}$)	V_{OH}	$V_{DD} - 0.3$	—	—	V
Output low voltage PA3–PA0 ($I_{Load} = 0.2\text{ mA}$) PA7–PA4 ($I_{Load} = 2.0\text{ mA}$)	V_{OL}	—	—	0.3 0.3	V

Table A-2. Low-Power Output Voltage ($V_{DD} = 2.5\text{--}3.6\text{ Vdc}$)

Characteristic	Symbol	Min	Typ	Max	Unit
Output high voltage PA7–PA0, PB5–PB0 ($I_{Load} = -0.2\text{ mA}$)	V_{OH}	$V_{DD} - 0.3$	—	—	V
Output low voltage PA3–PA0 ($I_{Load} = 0.4\text{ mA}$) PA7–PA4 ($I_{Load} = 5.0\text{ mA}$)	V_{OL}	—	—	0.3 0.3	V

Table A-3. Low-Power Supply Current

Characteristic	Symbol	Min	Typ ⁽¹⁾	Max	Unit
Supply current ($V_{DD} = 4.5\text{--}5.5\text{ Vdc}$, $f_{op} = 2.1\text{ MHz}$)	I_{DD}	—	3.0	4.0	mA
Run ⁽²⁾		—	1.6	2.5	mA
Wait ⁽³⁾		—	0.2	10	μA
Stop ⁽⁴⁾		—	2.0	20	μA
25°C		—	2.0	20	μA
0°C to 70°C (standard)					
Supply current ($V_{DD} = 2.5\text{--}3.6\text{ Vdc}$, $f_{op} = 1.0\text{ MHz}$)	I_{DD}	—	1.0	2.0	mA
Run ⁽²⁾		—	0.5	1.0	mA
Wait ⁽³⁾		—	0.1	5.0	μA
Stop ⁽⁴⁾		—	1.0	10.0	μA
25°C		—	1.0	10.0	μA
0°C to 70°C (standard)					
Supply current ($V_{DD} = 2.5\text{--}3.6\text{ Vdc}$, $f_{op} = 500\text{ kHz}$)	I_{DD}	—	0.5	1.0	mA
Run ⁽²⁾		—	250	500	μA
Wait ⁽³⁾		—	0.1	5.0	μA
Stop ⁽⁴⁾		—	1.0	10.0	μA
25°C		—	1.0	10.0	μA
0°C to 70°C (standard)					
Supply current ($V_{DD} = 1.8\text{--}2.4\text{ Vdc}$, $f_{op} = 500\text{ kHz}$)	I_{DD}	—	300	700	μA
Run ⁽²⁾		—	150	400	μA
Wait ⁽³⁾		—	0.1	2	μA
Stop ⁽⁴⁾		—	1.0	5	μA
25°C		—	1.0	5	μA
0°C to 70°C (standard)					

1. Typical values reflect average measurements at midpoint of voltage range at 25°C.
2. Run (operating) I_{DD} measured using external square wave clock source with all inputs 0.2 V from rail. No dc loads. Less than 50 pF on all outputs. $C_L = 20\text{ pF}$ on OSC2.
3. WAIT I_{DD} measured using external square wave clock source with all inputs 0.2 V from rail. No dc loads. Less than 50 pF on all outputs. $C_L = 20\text{ pF}$ on OSC2. All ports configured as inputs. $V_{IL} = 0.2\text{ V}$, $V_{IH} = V_{DD} - 0.2\text{ V}$. OSC2 capacitance linearly affects WAIT I_{DD} .
4. Stop I_{DD} measured with OSC1 = V_{DD} . All ports configured as inputs. $V_{IL} = 0.2\text{ V}$, $V_{IH} = V_{DD} - 0.2\text{ V}$.

Table A-4. Low-Power Pulldown Current

Characteristic	Symbol	Min	Typ ⁽¹⁾	Max	Unit
Pulldown current ($V_{DD} = 4.5\text{--}5.5$ Vdc, $f_{op} = 2.1$ MHz) PA7–PA0, PB5–PB0 (pulldown device on)	I_{IL}	50	100	200	μA
Pulldown current ($V_{DD} = 2.5\text{--}3.6$ Vdc, $f_{op} = 1.0$ MHz) PA7–PA0, PB5–PB0 (pulldown device on)	I_{IL}	8	30	100	μA
Pulldown current ($V_{DD} = 2.5\text{--}3.6$ Vdc, $f_{op} = 500$ kHz) PA7–PA0, PB5–PB0 (pulldown device on)	I_{IL}	3	10	50	μA
Pulldown current ($V_{DD} = 1.8\text{--}2.4$ Vdc, $f_{op} = 500$ kHz) PA7–PA0, PB5–PB0 (pulldown device on)	I_{IL}	3	10	50	μA

1. Typical values reflect average measurements at midpoint of voltage range at 25°C.

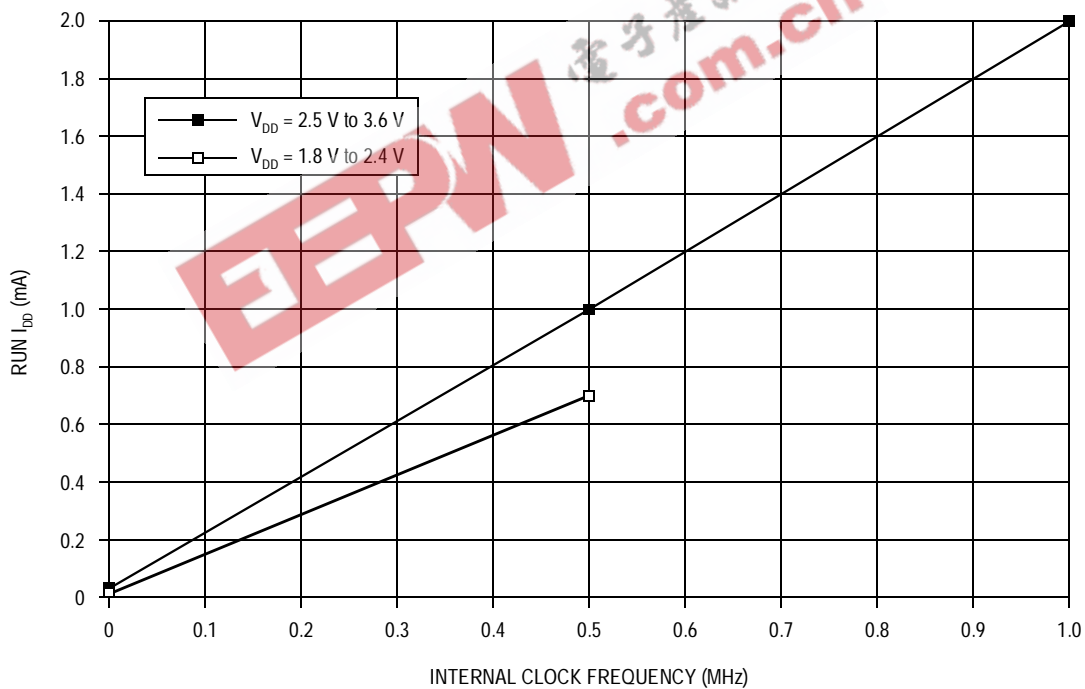

Figure A-1. Maximum Run Mode I_{DD} versus Frequency

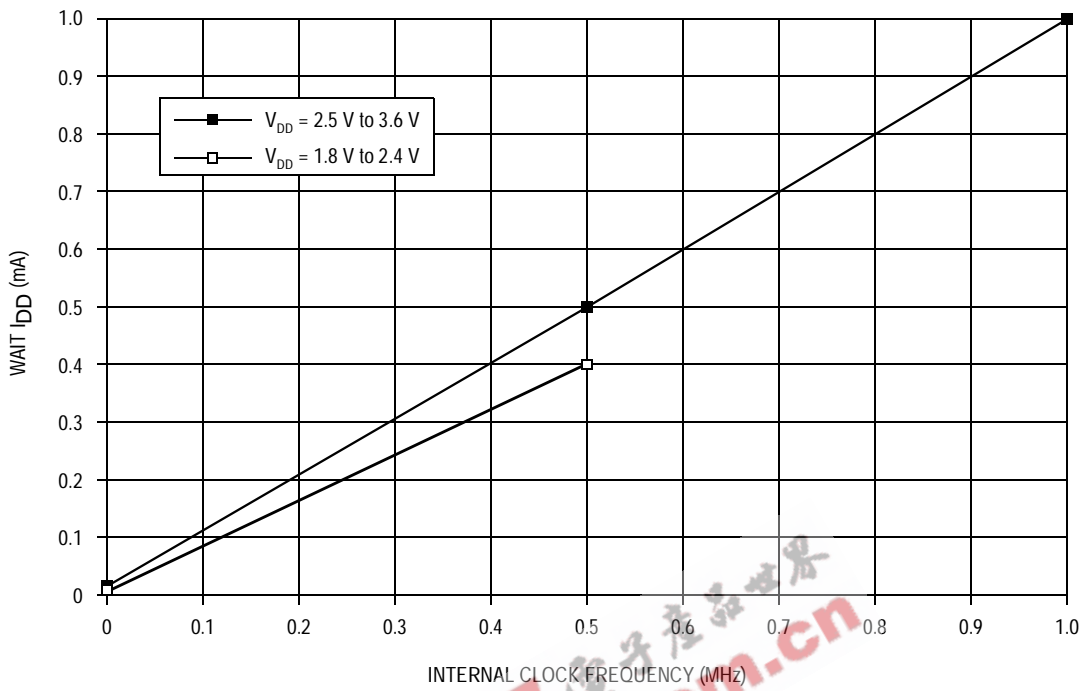

Figure A-2. Maximum Wait Mode I_{DD} versus Frequency

A.4 MC Ordering Information

Table A-5 gives order numbers for the available package types.

Table A-5. MC Order Numbers

Package Type	Temperature Range	Order Number
20-pin dual in-line package (DIP)	0°C to 70°C	MC68HCL05J1AP
20-pin small outline integrated circuit (SOIC)	0°C to 70°C	MC68HCL05J1ADW

EEPW 电子产品世界
.com.cn

Appendix B. MC68HSC05J1A

B.1 Contents

B.2	Introduction	123
B.3	DC Electrical Characteristics	124
B.4	Control Timing	125
B.5	MC Ordering Information	126

B.2 Introduction

This appendix introduces the MC68HSC05J1A, a high-speed version of the MC68HC05J1A. All of the information in this document applies to the MC68HSC05J1A with the exceptions given in this appendix.

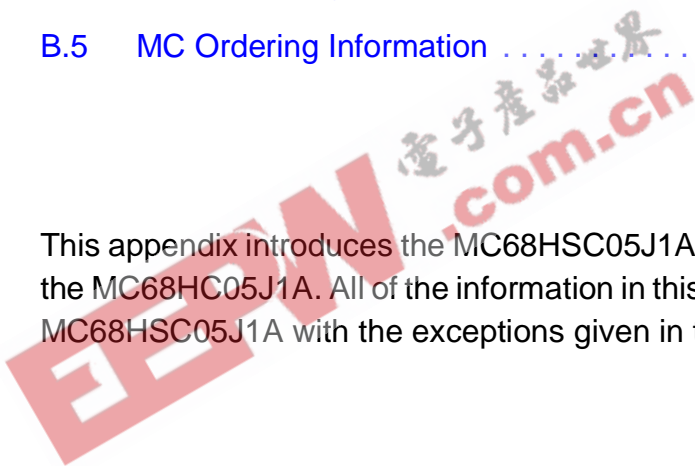

B.3 DC Electrical Characteristics

The data in [10.7 5.0-Volt DC Electrical Characteristics](#) and [10.8 3.3-Volt DC Electrical Characteristics](#) applies to the MC68HSC05J1A with the exceptions given in [Table B-1](#).

Table B-1. High-Speed Supply Current

Characteristic	Symbol	Min	Typ ⁽¹⁾	Max	Unit
Supply current ($V_{DD} = 4.5\text{--}5.5$ Vdc, $f_{OP} = 4.0$ MHz)					
Run ⁽²⁾	I_{DD}	—	4.5	6.0	mA
Wait ⁽³⁾		—	2.5	3.25	mA
Stop ⁽⁴⁾		—	0.2	10	μ A
25°C		—	2.0	20	μ A
–40°C to +85°C					
Supply current ($V_{DD} = 3.0\text{--}3.6$ Vdc, $f_{OP} = 2.1$ MHz)					
Run	I_{DD}	—	2.0	4.0	mA
Wait		—	1.0	2.0	mA
Stop		—	0.1	5.0	μ A
25°C		—	1.0	10	μ A
–40°C to +85°C					

1. Typical values reflect average measurements at midpoint of voltage range at 25°C.
2. Run (operating) I_{DD} measured using external square wave clock source with all inputs 0.2 V from rail. No dc loads. Less than 50 pF on all outputs. $C_L = 20$ pF on OSC2.
3. Wait I_{DD} measured using external square wave clock source with all inputs 0.2 V from rail. No dc loads. Less than 50 pF on all outputs. $C_L = 20$ pF on OSC2. All ports configured as inputs. $V_{IL} = 0.2$ V, $V_{IH} = V_{DD} - 0.2$ V. OSC2 capacitance linearly affects wait I_{DD} .
4. Stop I_{DD} measured with OSC1 = V_{DD} . All ports configured as inputs. $V_{IL} = 0.2$ V, $V_{IH} = V_{DD} - 0.2$ V.

B.4 Control Timing

The data in [10.9 5.0-Volt Control Timing](#) and [10.10 3.3-Volt Control Timing](#) applies to the MC68HSC05J1A with the exceptions given in [Table B-2](#) and [Table B-3](#).

Table B-2. High-Speed Control Timing ($V_{DD} = 5.0\text{ V} \pm 10\%$)

Characteristic	Symbol	Min	Max	Unit
Oscillator frequency Crystal oscillator ⁽¹⁾ Ceramic resonator External clock	f_{osc}	— — —	8.0 8.0 8.0	MHz
Internal operating frequency ($f_{OSC} \div 2$) Crystal oscillator ⁽¹⁾ Ceramic resonator External clock	f_{op}	— — —	4.0 4.0 4.0	MHz
Cycle time ($1 \div f_{OP}$)	t_{cyc}	250	—	ns
\overline{IRQ} pulse width low (edge-triggered)	t_{ILIL}	63	—	ns
PA3–PA0 interrupt pulse width (edge-triggered)	t_{IHIL}	63	—	ns
OSC1 pulse width	t_{OH} or t_{OL}	45	—	ns

1. Use only AT-cut crystals.

Table B-3. High-Speed Control Timing ($V_{DD} = 3.3\text{ V} \pm 10\%$)

Characteristic	Symbol	Min	Max	Unit
Oscillator frequency Crystal oscillator ⁽¹⁾ Ceramic resonator External clock	f_{osc}	— — —	4.2 4.2 4.2	MHz
Internal operating frequency ($f_{OSC} \div 2$) Crystal oscillator ⁽¹⁾ Ceramic resonator External clock	f_{op}	— — —	2.1 2.1 2.1	MHz
Cycle time ($1 \div f_{OP}$)	t_{cyc}	480	—	ns
\overline{IRQ} pulse width low (edge-triggered)	t_{ILIL}	125	—	ns
PA3–PA0 interrupt pulse width (edge-triggered)	t_{IHIL}	125	—	ns
OSC1 pulse width	t_{OH} or t_{OL}	90	—	ns

1. Use only AT-cut crystals.

B.5 MC Ordering Information

Table B-4 gives order numbers for the available package types.

Table B-4. MC Order Numbers

Package Type	Temperature Range	Order Number
20-pin dual in-line package (DIP)	0°C to 70°C	MC68HSC05J1AP
20-pin small outline integrated circuit (SOIC)	0°C to 70°C	MC68HSC05J1ADW

Freescale Semiconductor, Inc.



Freescale Semiconductor, Inc.

Freescale Semiconductor, Inc.

EEPW 电子产品世界
.com.cn

**For More Information On This Product,
Go to: www.freescale.com**

Freescale Semiconductor, Inc.

HOW TO REACH US:

USA/EUROPE/LOCATIONS NOT LISTED:

Motorola Literature Distribution;
P.O. Box 5405, Denver, Colorado 80217
1-303-675-2140 or 1-800-441-2447

JAPAN:

Motorola Japan Ltd.; SPS, Technical Information Center,
3-20-1, Minami-Azabu Minato-ku, Tokyo 106-8573 Japan
81-3-3440-3569

ASIA/PACIFIC:

Motorola Semiconductors H.K. Ltd.;
Silicon Harbour Centre, 2 Dai King Street,
Tai Po Industrial Estate, Tai Po, N.T., Hong Kong
852-26668334

TECHNICAL INFORMATION CENTER:

1-800-521-6274

HOME PAGE:

<http://www.motorola.com/semiconductors>

Information in this document is provided solely to enable system and software implementers to use Motorola products. There are no express or implied copyright licenses granted hereunder to design or fabricate any integrated circuits or integrated circuits based on the information in this document.

Motorola reserves the right to make changes without further notice to any products herein. Motorola makes no warranty, representation or guarantee regarding the suitability of its products for any particular purpose, nor does Motorola assume any liability arising out of the application or use of any product or circuit, and specifically disclaims any and all liability, including without limitation consequential or incidental damages. "Typical" parameters which may be provided in Motorola data sheets and/or specifications can and do vary in different applications and actual performance may vary over time. All operating parameters, including "Typicals" must be validated for each customer application by customer's technical experts. Motorola does not convey any license under its patent rights nor the rights of others. Motorola products are not designed, intended, or authorized for use as components in systems intended for surgical implant into the body, or other applications intended to support or sustain life, or for any other application in which the failure of the Motorola product could create a situation where personal injury or death may occur. Should Buyer purchase or use Motorola products for any such unintended or unauthorized application, Buyer shall indemnify and hold Motorola and its officers, employees, subsidiaries, affiliates, and distributors harmless against all claims, costs, damages, and expenses, and reasonable attorney fees arising out of, directly or indirectly, any claim of personal injury or death associated with such unintended or unauthorized use, even if such claim alleges that Motorola was negligent regarding the design or manufacture of the part.



Motorola and the Stylized M Logo are registered in the U.S. Patent and Trademark Office. digital dna is a trademark of Motorola, Inc. All other product or service names are the property of their respective owners. Motorola, Inc. is an Equal Opportunity/Affirmative Action Employer.

© Motorola, Inc. 2002

MC68HC05J1A/D

**For More Information On This Product,
Go to: www.freescale.com**