



MC78T00 Series

Three-Ampere Positive Voltage Regulators

This family of fixed voltage regulators are monolithic integrated circuits capable of driving loads in excess of 3.0 A. These three-terminal regulators employ internal current limiting, thermal shutdown, and safe-area compensation. Devices are available with improved specifications, including a 2% output voltage tolerance, on AC-suffix 5.0, 12 and 15 V device types.

Although designed primarily as a fixed voltage regulator, these devices can be used with external components to obtain adjustable voltages and currents. This series of devices can be used with a series-pass transistor to supply up to 15 A at the nominal output voltage.

- Output Current in Excess of 3.0 A
- Power Dissipation: 25 W
- No External Components Required
- Output Voltage Offered in 2% and 4% Tolerance*
- Thermal Regulation is Specified
- Internal Thermal Overload Protection
- Internal Short Circuit Current Limiting
- Output Transistor Safe-Area Compensation

THREE-AMPERE POSITIVE FIXED VOLTAGE REGULATORS

SEMICONDUCTOR TECHNICAL DATA

MAXIMUM RATINGS ($T_A = +25^\circ\text{C}$, unless otherwise noted.)

Rating	Symbol	Value	Unit
Input Voltage (5.0 V – 12 V) (15 V)	V_I	35 40	Vdc
Power Dissipation and Thermal Characteristics Plastic Package (Note 1) $T_A = +25^\circ\text{C}$ Thermal Resistance, Junction-to-Air $T_C = +25^\circ\text{C}$ Thermal Resistance, Junction-to-Case	P_D $R_{\theta JA}$ P_D $R_{\theta JC}$	Internally Limited 65 Internally Limited 2.5	$^\circ\text{C}/\text{W}$ $^\circ\text{C}/\text{W}$
Storage Junction Temperature	T_{stg}	+150	$^\circ\text{C}$
Operating Junction Temperature Range (MC78T00C, AC)	T_J	0 to +125	$^\circ\text{C}$

NOTES: 1. Although power dissipation is internally limited, specifications apply only for $P_O \leq P_{max}$, $P_{max} = 25 \text{ W}$.

T SUFFIX
PLASTIC PACKAGE
CASE 221A

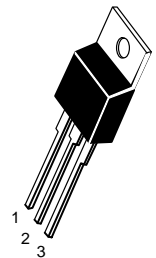

Pin 1. Input
2. Ground
3. Output

Heatsink surface is connected to Pin 2.

DEVICE TYPE/NOMINAL OUTPUT VOLTAGE

MC78T05	5.0 V	MC78T12	12 V
MC78T08	8.0 V	MC78T15	15 V

ORDERING INFORMATION

Device	V_O Tol.	Operating Temperature Range	Package
MC78TXXCT	4%	$T_J = 0^\circ$ to $+125^\circ\text{C}$	Plastic Power
MC78TXXACT	2%*		
MC78TXXBT#	4%	$T_J = -40^\circ$ to $+125^\circ\text{C}$	Plastic Power
MC78TXXABT#	2%*		

Simplified Application

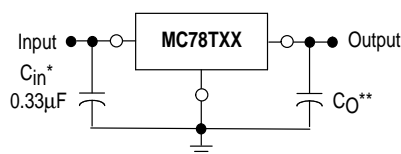

A common ground is required between the input and the output voltages. The input voltage must remain typically 2.2 V above the output voltage even during the low point on the input ripple voltage.

XX these two digits of the type number indicate voltage.

* C_{in} is required if regulator is located an appreciable distance from power supply filter. (See Applications Information for details.)

** C_O is not needed for stability; however, it does improve transient response.

XX Indicates nominal voltage.

* 2% regulators available in 5, 12 and 15 V devices.

Automotive temperature range selections are available with special test conditions and additional tests. Contact your local Motorola sales office for information.

MC78T00 Series

ELECTRICAL CHARACTERISTICS ($V_{in} = 10\text{ V}$, $I_O = 3.0\text{ A}$, $0^\circ\text{C} \leq T_J \leq 125^\circ\text{C}$, $P_O \leq P_{max}$ [Note 1], unless otherwise noted.)

Characteristics	Symbol	MC78T05AC			MC78T05C			Unit
		Min	Typ	Max	Min	Typ	Max	
Output Voltage ($5.0\text{ mA} \leq I_O \leq 3.0\text{ A}$, $T_J = +25^\circ\text{C}$) ($5.0\text{ mA} \leq I_O \leq 3.0\text{ A}$; $5.0\text{ mA} \leq I_O \leq 2.0\text{ A}$, $7.3\text{ Vdc} \leq V_{in} \leq 20\text{ Vdc}$)	V_O	4.9 4.8	5.0 5.0	5.1 5.2	4.8 4.75	5.0 5.0	5.2 5.25	Vdc
Line Regulation (Note 2) ($7.2\text{ Vdc} \leq V_{in} \leq 35\text{ Vdc}$, $I_O = 5.0\text{ mA}$, $T_J = +25^\circ\text{C}$; $7.2\text{ Vdc} \leq V_{in} \leq 35\text{ Vdc}$, $I_O = 1.0\text{ A}$, $T_J = +25^\circ\text{C}$; $8.0\text{ Vdc} \leq V_{in} \leq 12\text{ Vdc}$, $I_O = 3.0\text{ A}$, $T_J = +25^\circ\text{C}$; $7.5\text{ Vdc} \leq V_{in} \leq 20\text{ Vdc}$, $I_O = 1.0\text{ A}$)	Reg _{line}	–	3.0	25	–	3.0	25	mV
Load Regulation (Note 2) ($5.0\text{ mA} \leq I_O \leq 3.0\text{ A}$, $T_J = +25^\circ\text{C}$) ($5.0\text{ mA} \leq I_O \leq 3.0\text{ A}$)	Reg _{load}	– –	10 15	30 80	– –	10 15	30 80	mV
Thermal Regulation (Pulse = 10 ms, P = 20 W, $T_A = +25^\circ\text{C}$)	Reg _{therm}	–	0.001	0.01	–	0.002	0.03	% V_O /W
Quiescent Current ($5.0\text{ mA} \leq I_O \leq 3.0\text{ A}$, $T_J = +25^\circ\text{C}$) ($5.0\text{ mA} \leq I_O \leq 3.0\text{ A}$)	I_B	– –	3.5 4.0	5.0 6.0	– –	3.5 4.0	5.0 6.0	mA
Quiescent Current Change ($7.2\text{ Vdc} \leq V_{in} \leq 35\text{ Vdc}$, $I_O = 5.0\text{ mA}$, $T_J = +25^\circ\text{C}$; $5.0\text{ mA} \leq I_O \leq 3.0\text{ A}$, $T_J = +25^\circ\text{C}$; $7.5\text{ Vdc} \leq V_{in} \leq 20\text{ Vdc}$, $I_O = 1.0\text{ A}$)	ΔI_B	–	0.3	1.0	–	0.3	1.0	mA
Ripple Rejection ($8.0\text{ Vdc} \leq V_{in} \leq 18\text{ Vdc}$, $f = 120\text{ Hz}$, $I_O = 2.0\text{ A}$, $T_J = 25^\circ\text{C}$)	RR	62	75	–	62	75	–	dB
Dropout Voltage ($I_O = 3.0\text{ A}$, $T_J = +25^\circ\text{C}$)	$V_{in}-V_O$	–	2.2	2.5	–	2.2	2.5	Vdc
Output Noise Voltage ($10\text{ Hz} \leq f \leq 100\text{ kHz}$, $T_J = +25^\circ\text{C}$)	V_n	–	10	–	–	10	–	$\mu\text{V}/V_O$
Output Resistance ($f = 1.0\text{ kHz}$)	R_O	–	2.0	–	–	20	–	$\text{m}\Omega$
Short Circuit Current Limit ($V_{in} = 35\text{ Vdc}$, $T_J = +25^\circ\text{C}$)	I_{SC}	–	1.5	–	–	1.5	–	A
Peak Output Current ($T_J = +25^\circ\text{C}$)	I_{max}	–	5.0	–	–	5.0	–	A
Average Temperature Coefficient of Output Voltage ($I_O = 5.0\text{ mA}$)	TCV_O	–	0.2	–	–	0.2	–	$\text{mV}/^\circ\text{C}$

NOTES: 1. Although power dissipation is internally limited, specifications apply only for $P_O \leq P_{max}$. $P_{max} = 25\text{ W}$.

2. Line and load regulation are specified at constant junction temperature. Changes in V_O due to heating effects must be taken into account separately. Pulse testing with low duty cycle is used.

MC78T00 Series

ELECTRICAL CHARACTERISTICS ($V_{in} = 13\text{ V}$, $I_O = 3.0\text{ A}$, $0^\circ\text{C} \leq T_J \leq 125^\circ\text{C}$, $P_O \leq P_{max}$ [Note 1], unless otherwise noted.)

Characteristics	Symbol	MC78T08C			Unit
		Min	Typ	Max	
Output Voltage ($5.0\text{ mA} \leq I_O \leq 3.0\text{ A}$, $T_J = +25^\circ\text{C}$) ($5.0\text{ mA} \leq I_O \leq 3.0\text{ A}$; $5.0\text{ mA} \leq I_O \leq 2.0\text{ A}$, $10.4\text{ Vdc} \leq V_{in} \leq 23\text{ Vdc}$)	V_O	7.7 7.6	8.0 8.0	8.3 8.4	Vdc
Line Regulation (Note 2) ($10.3\text{ Vdc} \leq V_{in} \leq 35\text{ Vdc}$, $I_O = 5.0\text{ mA}$, $T_J = +25^\circ\text{C}$) ($10.3\text{ Vdc} \leq V_{in} \leq 35\text{ Vdc}$, $I_O = 1.0\text{ A}$, $T_J = +25^\circ\text{C}$) ($11\text{ Vdc} \leq V_{in} \leq 17\text{ Vdc}$, $I_O = 3.0\text{ A}$, $T_J = +25^\circ\text{C}$) ($10.7\text{ Vdc} \leq V_{in} \leq 23\text{ Vdc}$, $I_O = 1.0\text{ A}$)	Regline	–	4.0	35	mV
Load Regulation (Note 2) ($5.0\text{ mA} \leq I_O \leq 3.0\text{ A}$, $T_J = +25^\circ\text{C}$) ($5.0\text{ mA} \leq I_O \leq 3.0\text{ A}$)	Regload	– –	10 15	30 80	mV
Thermal Regulation (Pulse = 10 ms, $P = 20\text{ W}$, $T_A = +25^\circ\text{C}$)	Regtherm	–	0.002	0.03	% V_O /W
Quiescent Current ($5.0\text{ mA} \leq I_O \leq 3.0\text{ A}$, $T_J = +25^\circ\text{C}$) ($5.0\text{ mA} \leq I_O \leq 3.0\text{ A}$)	I_B	– –	3.5 4.0	5.0 6.0	mA
Quiescent Current Change ($10.3\text{ Vdc} \leq V_{in} \leq 35\text{ Vdc}$, $I_O = 5.0\text{ mA}$, $T_J = +25^\circ\text{C}$; $5.0\text{ mA} \leq I_O \leq 3.0\text{ A}$, $T_J = +25^\circ\text{C}$; $10.7\text{ Vdc} \leq V_{in} \leq 23\text{ Vdc}$, $I_O = 1.0\text{ A}$)	ΔI_B	–	0.3	1.0	mA
Ripple Rejection ($11\text{ Vdc} \leq V_{in} \leq 21\text{ Vdc}$, $f = 120\text{ Hz}$, $I_O = 2.0\text{ A}$, $T_J = 25^\circ\text{C}$)	RR	60	71	–	dB
Dropout Voltage ($I_O = 3.0\text{ A}$, $T_J = +25^\circ\text{C}$)	V_{in-V_O}	–	2.2	2.5	Vdc
Output Noise Voltage ($10\text{ Hz} \leq f \leq 100\text{ kHz}$, $T_J = +25^\circ\text{C}$)	V_n	–	10	–	$\mu\text{V}/V_O$
Output Resistance ($f = 1.0\text{ kHz}$)	R_O	–	2.0	–	$\text{m}\Omega$
Short Circuit Current Limit ($V_{in} = 35\text{ Vdc}$, $T_J = +25^\circ\text{C}$)	I_{SC}	–	1.5	–	A
Peak Output Current ($T_J = +25^\circ\text{C}$)	I_{max}	–	5.0	–	A
Average Temperature Coefficient of Output Voltage ($I_O = 5.0\text{ mA}$)	TCV_O	–	0.3	–	$\text{mV}/^\circ\text{C}$

NOTES: 1. Although power dissipation is internally limited, specifications apply only for $P_O \leq P_{max}$. $P_{max} = 25\text{ W}$.

2. Line and load regulation are specified at constant junction temperature. Changes in V_O due to heating effects must be taken into account separately. Pulse testing with low duty cycle is used.

MC78T00 Series

ELECTRICAL CHARACTERISTICS ($V_{in} = 17\text{ V}$, $I_O = 3.0\text{ A}$, $0^\circ\text{C} \leq T_J \leq 125^\circ\text{C}$, $P_O \leq P_{max}$ [Note 1], unless otherwise noted.)

Characteristics	Symbol	MC78T12AC			MC78T12C			Unit
		Min	Typ	Max	Min	Typ	Max	
Output Voltage ($5.0\text{ mA} \leq I_O \leq 3.0\text{ A}$, $T_J = +25^\circ\text{C}$) ($5.0\text{ mA} \leq I_O \leq 3.0\text{ A}$, $5.0\text{ mA} \leq I_O \leq 2.0\text{ A}$, $14.5\text{ Vdc} \leq V_{in} \leq 27\text{ Vdc}$)	V_O	11.75 11.5	12 12	12.25 12.5	11.5 11.4	12 12	12.5 12.6	Vdc
Line Regulation (Note 2) ($14.5\text{ Vdc} \leq V_{in} \leq 35\text{ Vdc}$, $I_O = 5.0\text{ mA}$, $T_J = +25^\circ\text{C}$; $14.5\text{ Vdc} \leq V_{in} \leq 35\text{ Vdc}$, $I_O = 1.0\text{ A}$, $T_J = +25^\circ\text{C}$; $16\text{ Vdc} \leq V_{in} \leq 22\text{ Vdc}$, $I_O = 3.0\text{ A}$, $T_J = +25^\circ\text{C}$; $14.9\text{ Vdc} \leq V_{in} \leq 27\text{ Vdc}$, $I_O = 1.0\text{ A}$)	Regline	–	6.0	45	–	6.0	45	mV
Load Regulation (Note 2) ($5.0\text{ mA} \leq I_O \leq 3.0\text{ A}$, $T_J = +25^\circ\text{C}$) ($5.0\text{ mA} \leq I_O \leq 3.0\text{ A}$)	Regload	– –	10 15	30 80	– –	10 15	30 80	mV
Thermal Regulation (Pulse = 10 ms, $P = 20\text{ W}$, $T_A = +25^\circ\text{C}$)	Reg _{therm}	–	0.001	0.01	–	0.002	0.03	% V_O /W
Quiescent Current ($5.0\text{ mA} \leq I_O \leq 3.0\text{ A}$, $T_J = +25^\circ\text{C}$) ($5.0\text{ mA} \leq I_O \leq 3.0\text{ A}$)	I_B	– –	3.5 4.0	5.0 6.0	– –	3.5 4.0	5.0 6.0	mA
Quiescent Current Change ($14.5\text{ Vdc} \leq V_{in} \leq 35\text{ Vdc}$, $I_O = 5.0\text{ mA}$, $T_J = +25^\circ\text{C}$; $5.0\text{ mA} \leq I_O \leq 3.0\text{ A}$, $T_J = +25^\circ\text{C}$; $14.9\text{ Vdc} \leq V_{in} \leq 27\text{ Vdc}$, $I_O = 1.0\text{ A}$)	ΔI_B	–	0.3	1.0	–	0.3	1.0	mA
Ripple Rejection ($15\text{ Vdc} \leq V_{in} \leq 25\text{ Vdc}$, $f = 120\text{ Hz}$, $I_O = 2.0\text{ A}$, $T_J = 25^\circ\text{C}$)	RR	57	67	–	57	67	–	dB
Dropout Voltage ($I_O = 3.0\text{ A}$, $T_J = +25^\circ\text{C}$)	$V_{in} - V_O$	–	2.2	2.5	–	2.2	2.5	Vdc
Output Noise Voltage ($10\text{ Hz} \leq f \leq 100\text{ kHz}$, $T_J = +25^\circ\text{C}$)	V_n	–	10	–	–	10	–	$\mu\text{V}/V_O$
Output Resistance ($f = 1.0\text{ kHz}$)	R_O	–	2.0	–	–	20	–	$\text{m}\Omega$
Short Circuit Current Limit ($V_{in} = 35\text{ Vdc}$, $T_J = +25^\circ\text{C}$)	I_{SC}	–	1.5	–	–	1.5	–	A
Peak Output Current ($T_J = +25^\circ\text{C}$)	I_{max}	–	5.0	–	–	5.0	–	A
Average Temperature Coefficient of Output Voltage ($I_O = 5.0\text{ mA}$)	TCV_O	–	0.5	–	–	0.5	–	$\text{mV}/^\circ\text{C}$

NOTES: 1. Although power dissipation is internally limited, specifications apply only for $P_O \leq P_{max}$. $P_{max} = 25\text{ W}$.

2. Line and load regulation are specified at constant junction temperature. Changes in V_O due to heating effects must be taken into account separately. Pulse testing with low duty cycle is used.

MC78T00 Series

ELECTRICAL CHARACTERISTICS ($V_{in} = 20\text{ V}$, $I_O = 3.0\text{ A}$, $0^\circ\text{C} \leq T_J \leq 125^\circ\text{C}$, $P_O \leq P_{max}$ [Note 1], unless otherwise noted.)

Characteristics	Symbol	MC78T15AC			MC78T15C			Unit
		Min	Typ	Max	Min	Typ	Max	
Output Voltage ($5.0\text{ mA} \leq I_O \leq 3.0\text{ A}$, $T_J = +25^\circ\text{C}$) ($5.0\text{ mA} \leq I_O \leq 3.0\text{ A}$; $5.0\text{ mA} \leq I_O \leq 2.0\text{ A}$, $17.5\text{ Vdc} \leq V_{in} \leq 30\text{ Vdc}$)	V_O	14.7 14.4	15 15	15.3 15.6	14.4 14.25	15 15	15.6 15.75	Vdc
Line Regulation (Note 2) ($17.6\text{ Vdc} \leq V_{in} \leq 40\text{ Vdc}$, $I_O = 5.0\text{ mA}$, $T_J = +25^\circ\text{C}$; $17.6\text{ Vdc} \leq V_{in} \leq 40\text{ Vdc}$, $I_O = 1.0\text{ A}$, $T_J = +25^\circ\text{C}$; $20\text{ Vdc} \leq V_{in} \leq 26\text{ Vdc}$, $I_O = 3.0\text{ A}$, $T_J = +25^\circ\text{C}$; $18\text{ Vdc} \leq V_{in} \leq 30\text{ Vdc}$, $I_O = 1.0\text{ A}$)	Regline	–	7.5	55	–	7.5	55	mV
Load Regulation (Note 2) ($5.0\text{ mA} \leq I_O \leq 3.0\text{ A}$, $T_J = +25^\circ\text{C}$) ($5.0\text{ mA} \leq I_O \leq 3.0\text{ A}$)	Regload	– –	10 15	30 80	– –	10 15	30 80	mV
Thermal Regulation (Pulse = 10 ms, $P = 20\text{ W}$, $T_A = +25^\circ\text{C}$)	Regtherm	–	0.001	0.01	–	0.002	0.03	% V_O /W
Quiescent Current ($5.0\text{ mA} \leq I_O \leq 3.0\text{ A}$, $T_J = +25^\circ\text{C}$) ($5.0\text{ mA} \leq I_O \leq 3.0\text{ A}$)	I_B	– –	3.5 4.0	5.0 6.0	– –	3.5 4.0	5.0 6.0	mA
Quiescent Current Change ($17.6\text{ Vdc} \leq V_{in} \leq 40\text{ Vdc}$, $I_O = 5.0\text{ mA}$, $T_J = +25^\circ\text{C}$; $5.0\text{ mA} \leq I_O \leq 3.0\text{ A}$, $T_J = +25^\circ\text{C}$; $18\text{ Vdc} \leq V_{in} \leq 30\text{ Vdc}$, $I_O = 1.0\text{ A}$)	ΔI_B	–	0.3	1.0	–	0.3	1.0	mA
Ripple Rejection ($18.5\text{ Vdc} \leq V_{in} \leq 28.5\text{ Vdc}$, $f = 120\text{ Hz}$, $I_O = 2.0\text{ A}$, $T_J = 25^\circ\text{C}$)	RR	55	65	–	55	65	–	dB
Dropout Voltage ($I_O = 3.0\text{ A}$, $T_J = +25^\circ\text{C}$)	$V_{in} - V_O$	–	2.2	2.5	–	2.2	2.5	Vdc
Output Noise Voltage ($10\text{ Hz} \leq f \leq 100\text{ kHz}$, $T_J = +25^\circ\text{C}$)	V_n	–	10	–	–	10	–	$\mu\text{V}/V_O$
Output Resistance ($f = 1.0\text{ kHz}$)	R_O	–	2.0	–	–	20	–	$\text{m}\Omega$
Short Circuit Current Limit ($V_{in} = 40\text{ Vdc}$, $T_J = +25^\circ\text{C}$)	I_{SC}	–	1.0	–	–	1.0	–	A
Peak Output Current ($T_J = +25^\circ\text{C}$)	I_{max}	–	5.0	–	–	5.0	–	A
Average Temperature Coefficient of Output Voltage ($I_O = 5.0\text{ mA}$)	TCV_O	–	0.6	–	–	0.6	–	$\text{mV}/^\circ\text{C}$

NOTES: 1. Although power dissipation is internally limited, specifications apply only for $P_O \leq P_{max}$, $P_{max} = 25\text{ W}$.

2. Line and load regulation are specified at constant junction temperature. Changes in V_O due to heating effects must be taken into account separately. Pulse testing with low duty cycle is used.

MC78T00 Series

VOLTAGE REGULATOR PERFORMANCE

The performance of a voltage regulator is specified by its immunity to changes in load, input voltage, power dissipation, and temperature. Line and load regulation are tested with a pulse of short duration ($< 100\mu\text{s}$) and are strictly a function of electrical gain. However, pulse widths of longer duration ($> 1.0\text{ ms}$) are sufficient to affect temperature gradients across the die. These temperature gradients can cause a change in the output voltage, in addition to changes caused by line and load regulation. Longer pulse widths and thermal gradients make it desirable to specify thermal regulation.

Thermal regulation is defined as the change in output voltage caused by a change in dissipated power for a specified time, and is expressed as a percentage output voltage change per watt. The change in dissipated power

can be caused by a change in either the input voltage or the load current. Thermal regulation is a function of IC layout and die attach techniques, and usually occurs within 10 ms of a change in power dissipation. After 10 ms, additional changes in the output voltage are due to the temperature coefficient of the device.

Figure 1 shows the line and thermal regulation response of a typical MC78T05AC to a 20 W input pulse. The variation of the output voltage due to line regulation is labeled ① and the thermal regulation component is labeled ②. Figure 2 shows the load and thermal regulation response of a typical MC78T05AC to a 20 W load pulse. The output voltage variation due to load regulation is labeled ① and the thermal regulation component is labeled ②.

Figure 1. MC78T05AC Line and Thermal Regulation

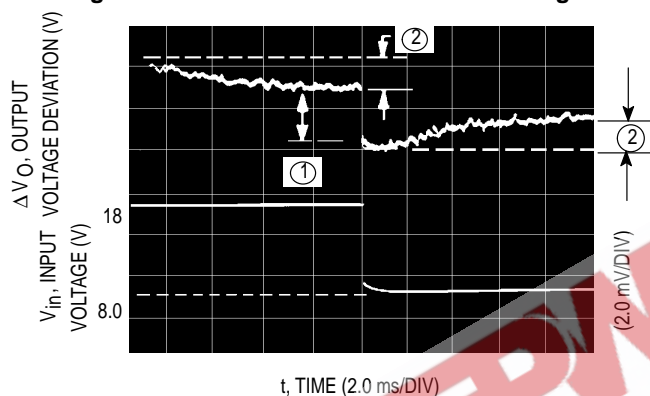

$V_{out} = 5.0\text{ V}$
 $V_{in} = 8.0\text{ V} \rightarrow 18\text{ V} \rightarrow 8.0\text{ V}$
 $I_{out} = 2.0\text{ A}$

① = $\text{Reg}_{line} = 2.4\text{ mV}$
 ② = $\text{Reg}_{therm} = 0.0015\%V_O/W$

Figure 2. MC78T05AC Load and Thermal Regulation

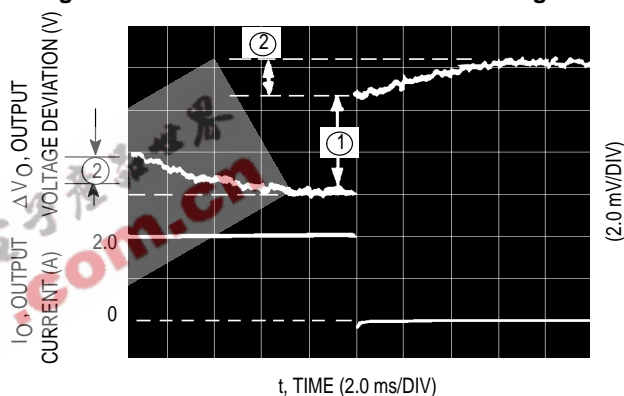

$V_{out} = 5.0\text{ V}$
 $V_{in} = 15$
 $I_{out} = 0\text{ A} \rightarrow 2.0\text{ A} \rightarrow 0\text{ A}$

① = $\text{Reg}_{line} = 4.4\text{ mV}$
 ② = $\text{Reg}_{therm} = 0.0015\%V_O/W$

Representative Schematic Diagram

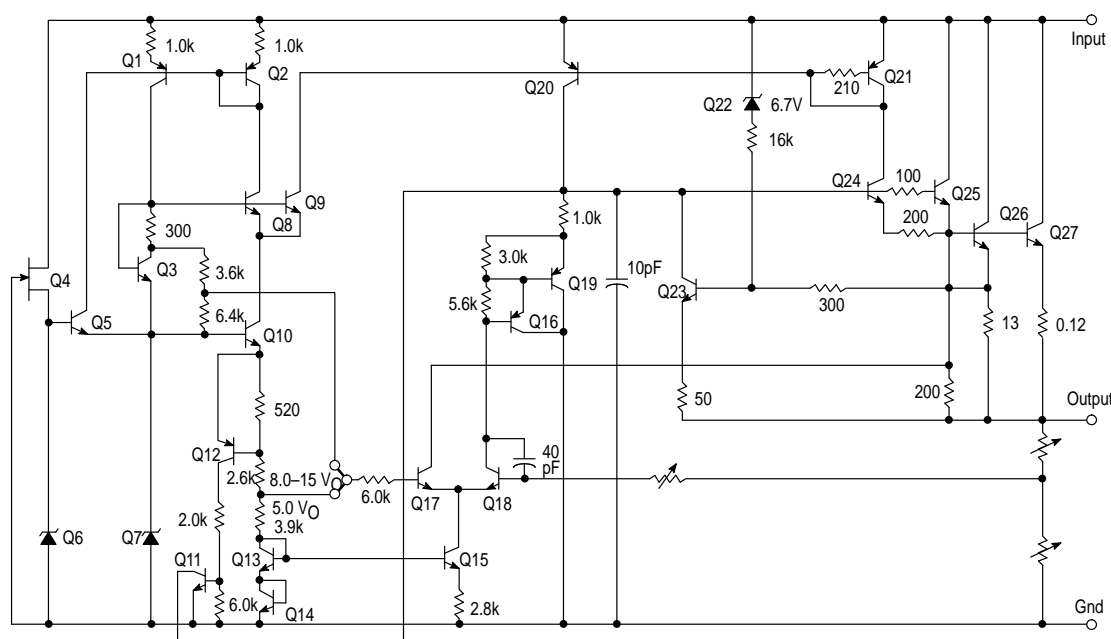

MC78T00 Series

Figure 3. Temperature Stability

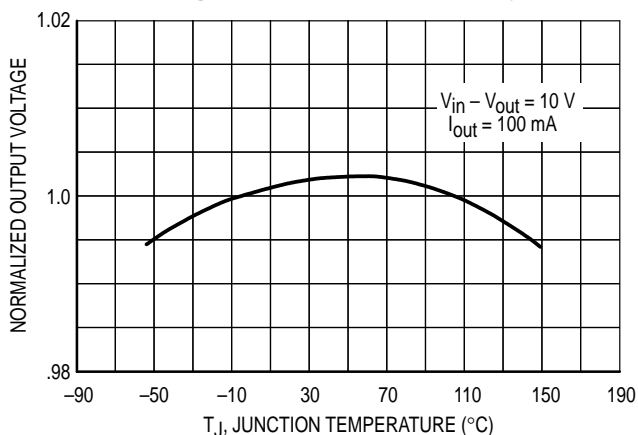

Figure 4. Output Impedance

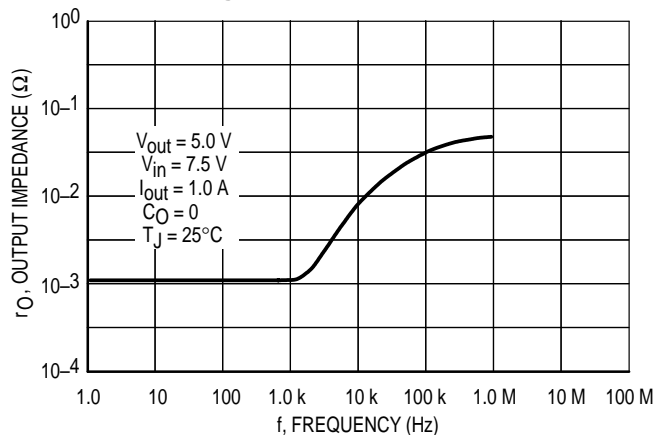

Figure 5. Ripple Rejection versus Frequency

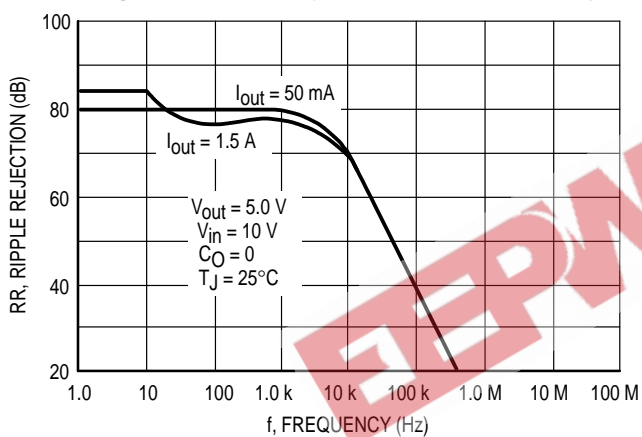

Figure 6. Ripple Rejection versus Output Current

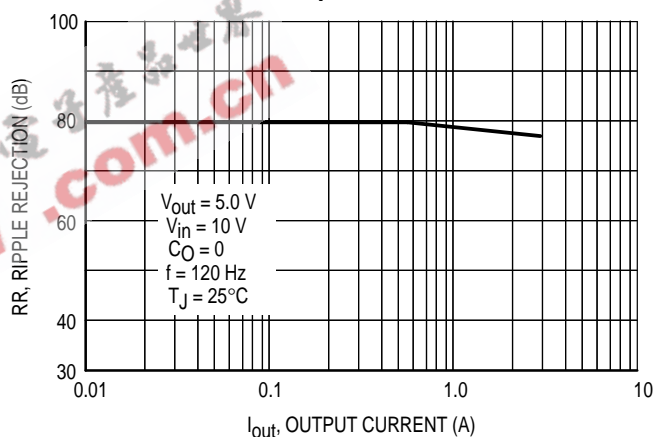

Figure 7. Quiescent Current versus Input Voltage

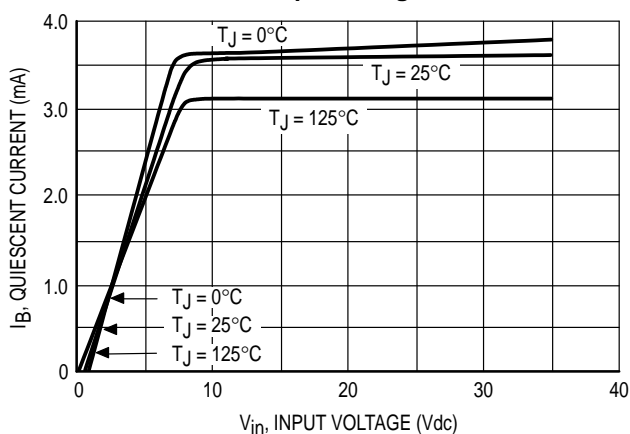
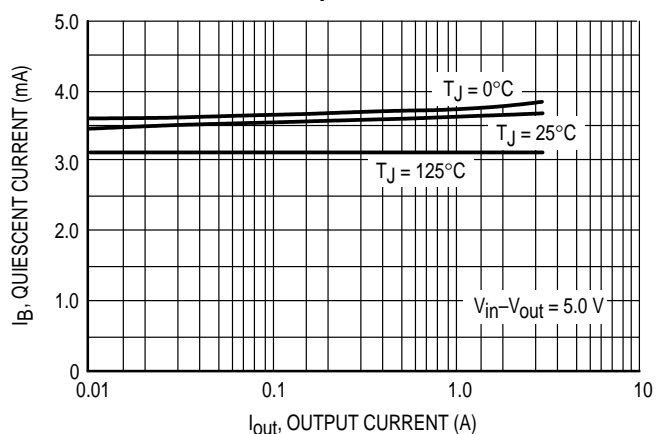

Figure 8. Quiescent Current versus Output Current



MC78T00 Series

Figure 9. Dropout Voltage

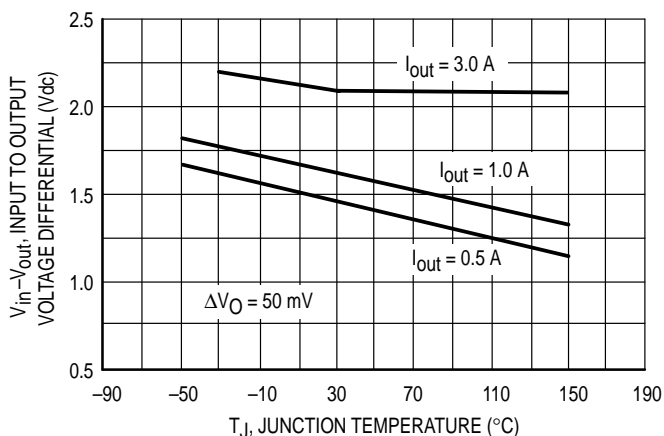

Figure 10. Peak Output Current

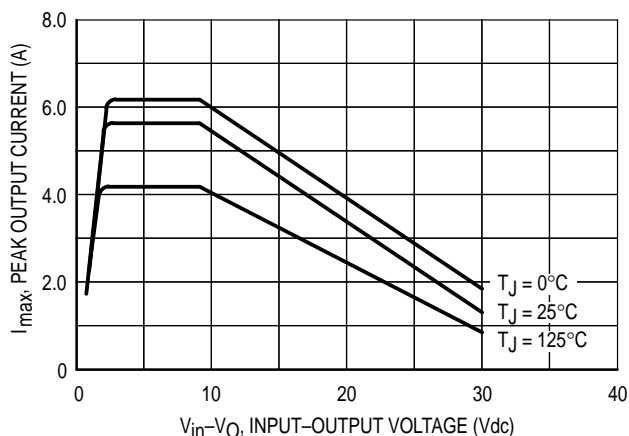

Figure 11. Line Transient Response

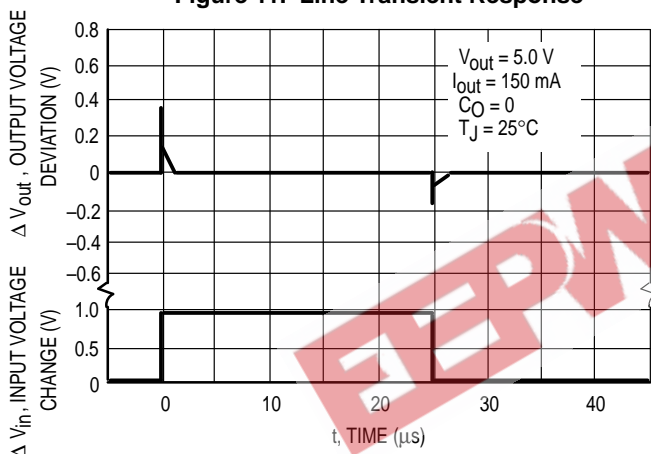

Figure 12. Load Transient Response

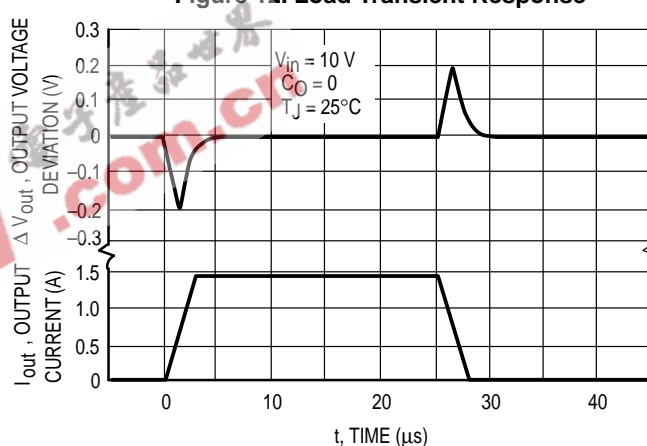
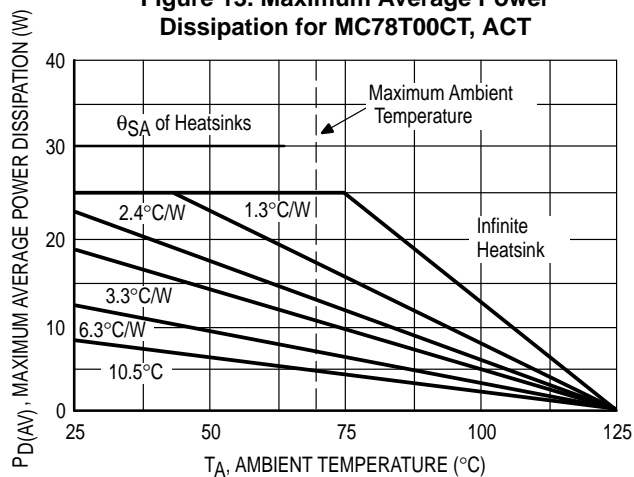

Figure 13. Maximum Average Power Dissipation for MC78T00CT, ACT



MC78T00 Series

APPLICATIONS INFORMATION

Design Considerations

The MC78T00 Series of fixed voltage regulators are designed with Thermal Overload Protection that shuts down the circuit when subjected to an excessive power overload condition, Internal Short Circuit Protection that limits the maximum current the circuit will pass, and Output Transistor Safe-Area Compensation that reduces the output short circuit current as the voltage across the pass transistor is increased.

In many low current applications, compensation capacitors are not required. However, it is recommended that the regulator input be bypassed with a capacitor if the

regulator is connected to the power supply filter with long wire lengths, or if the output load capacitance is large. An input bypass capacitor should be selected to provide good high frequency characteristics to insure stable operation under all load conditions. A 0.33 μF or larger tantalum, mylar, or other capacitor having low internal impedance at high frequencies should be chosen. The bypass capacitor should be mounted with the shortest possible leads directly across the regulator's input terminals. Normally good construction techniques should be used to minimize ground loops and lead resistance drops since the regulator has no external sense lead.

Figure 14. Current Regulator

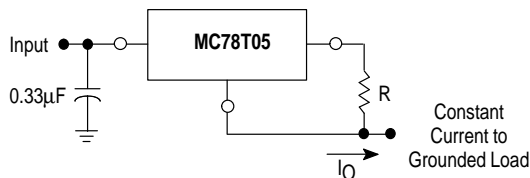

The MC78T05 regulator can also be used as a current source when connected as above. In order to minimize dissipation the MC78T05 is chosen in this application. Resistor R determines the current as follows:

$$I_O = \frac{5.0 \text{ V}}{R} + I_B$$

$\Delta I_B \cong 0.7 \text{ mA}$ over line, load and Temperature changes

$I_B \cong 3.5 \text{ mA}$

For example, a 2.0 A current source would require R to be a 2.5 Ω , 10 W resistor and the output voltage compliance would be the input voltage less 7.0 V.

Figure 15. Adjustable Output Regulator

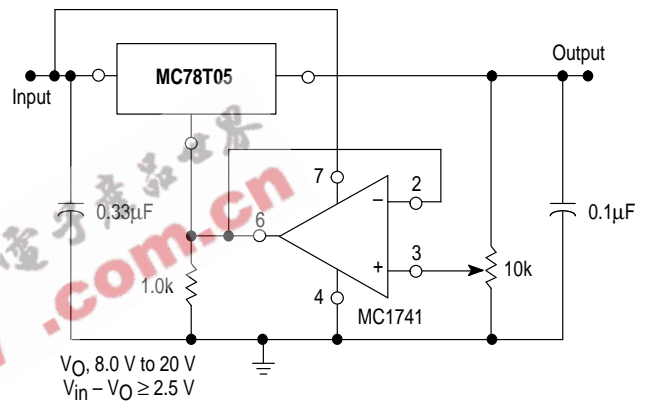

V_O , 8.0 V to 20 V
 $V_{in} - V_O \geq 2.5 \text{ V}$

The addition of an operational amplifier allows adjustment to higher or intermediate values while retaining regulation characteristics. The minimum voltage obtainable with this arrangement is 3.0 V greater than the regulator voltage.

Figure 16. Current Boost Regulator

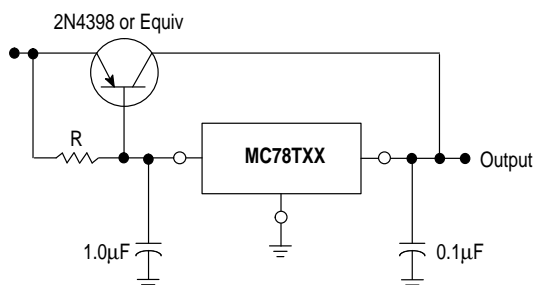

XX = 2 digits of type number indicating voltage.

The MC78T00 series can be current boosted with a PNP transistor. The 2N4398 provides current to 15 A. Resistor R in conjunction with the V_{BE} of the PNP determines when the pass transistor begins conducting; this circuit is not short circuit proof. Input-output differential voltage minimum is increased by the V_{BE} of the pass transistor.

Figure 17. Current Boost With Short Circuit Protection

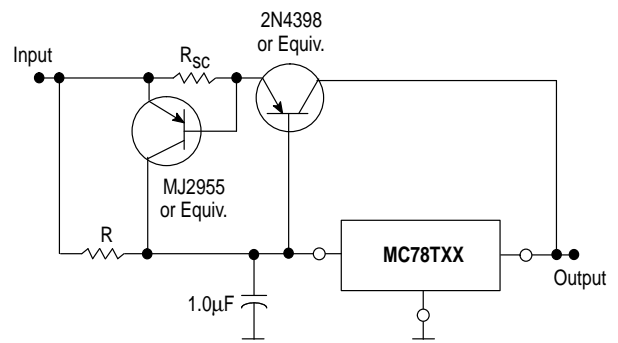

XX = 2 digits of type number indicating voltage.

The circuit of Figure 17 can be modified to provide supply protection against short circuits by adding a short circuit sense resistor, R_{SC} , and an additional PNP transistor. The current sensing PNP must be able to handle the short circuit current of the three-terminal regulator. Therefore, an eight-ampere power transistor is specified.

MC78T00 Series OUTLINE DIMENSIONS

T SUFFIX
PLASTIC PACKAGE
CASE 221A-06
ISSUE Y

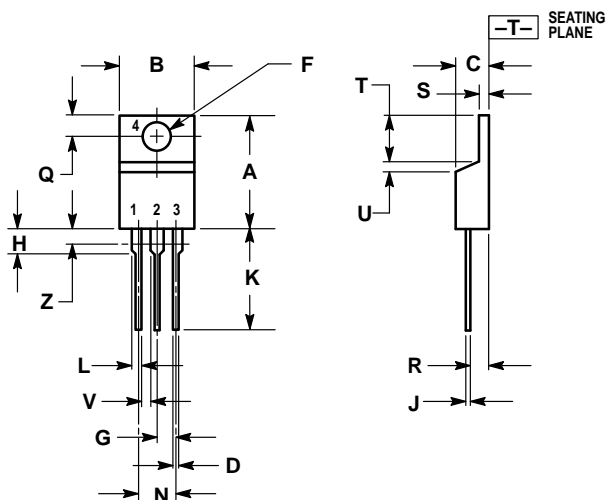

NOTES:

1. DIMENSIONING AND TOLERANCING PER ANSI Y14.5M, 1982.
2. CONTROLLING DIMENSION: INCH.
3. DIMENSION Z DEFINES A ZONE WHERE ALL BODY AND LEAD IRREGULARITIES ARE ALLOWED.

DIM	INCHES		MILLIMETERS	
	MIN	MAX	MIN	MAX
A	0.570	0.620	14.48	15.75
B	0.380	0.405	9.66	10.28
C	0.160	0.190	4.07	4.82
D	0.025	0.035	0.64	0.88
F	0.142	0.147	3.61	3.73
G	0.095	0.105	2.42	2.66
H	0.110	0.155	2.80	3.93
J	0.018	0.025	0.46	0.64
K	0.500	0.562	12.70	14.27
L	0.045	0.060	1.15	1.52
N	0.190	0.210	4.83	5.33
Q	0.100	0.120	2.54	3.04
R	0.080	0.110	2.04	2.79
S	0.045	0.055	1.15	1.39
T	0.235	0.255	5.97	6.47
U	0.000	0.050	0.00	1.27
V	0.045	—	1.15	—
Z	—	0.080	—	2.04

EEPW.com.cn 电子产品世界

MC78T00 Series

EEPW 电子產品世界
.com.cn

Motorola reserves the right to make changes without further notice to any products herein. Motorola makes no warranty, representation or guarantee regarding the suitability of its products for any particular purpose, nor does Motorola assume any liability arising out of the application or use of any product or circuit, and specifically disclaims any and all liability, including without limitation consequential or incidental damages. "Typical" parameters which may be provided in Motorola data sheets and/or specifications can and do vary in different applications and actual performance may vary over time. All operating parameters, including "Typicals" must be validated for each customer application by customer's technical experts. Motorola does not convey any license under its patent rights nor the rights of others. Motorola products are not designed, intended, or authorized for use as components in systems intended for surgical implant into the body, or other applications intended to support or sustain life, or for any other application in which the failure of the Motorola product could create a situation where personal injury or death may occur. Should Buyer purchase or use Motorola products for any such unintended or unauthorized application, Buyer shall indemnify and hold Motorola and its officers, employees, subsidiaries, affiliates, and distributors harmless against all claims, costs, damages, and expenses, and reasonable attorney fees arising out of, directly or indirectly, any claim of personal injury or death associated with such unintended or unauthorized use, even if such claim alleges that Motorola was negligent regarding the design or manufacture of the part. Motorola and  registered trademarks of Motorola, Inc. Motorola, Inc. is an Equal Opportunity/Affirmative Action Employer.

MC78T00 Series

EEPW 电子产品世界
.com.cn

How to reach us:

USA/EUROPE/Locations Not Listed: Motorola Literature Distribution;
P.O. Box 20912; Phoenix, Arizona 85036. 1-800-441-2447 or 602-303-5454

MFAX: RMFAX0@email.sps.mot.com – TOUCHTONE 602-244-6609
INTERNET: <http://Design-NET.com>

JAPAN: Nippon Motorola Ltd.; Tatsumi-SPD-JLDC, 6F Seibu-Butsuryu-Center,
3-14-2 Tatsumi Koto-Ku, Tokyo 135, Japan. 03-81-3521-8315

ASIA/PACIFIC: Motorola Semiconductors H.K. Ltd.; 8B Tai Ping Industrial Park,
51 Ting Kok Road, Tai Po, N.T., Hong Kong. 852-26629298



MOTOROLA



MC78T00/D

