

MC74HC4060A

14-Stage Binary Ripple Counter With Oscillator

High-Performance Silicon-Gate CMOS

The MC74HC4060A is identical in pinout to the standard CMOS MC14060B. The device inputs are compatible with standard CMOS outputs; with pullup resistors, they are compatible with LSTTL outputs.

This device consists of 14 master-slave flip-flops and an oscillator with a frequency that is controlled either by a crystal or by an RC circuit connected externally. The output of each flip-flop feeds the next and the frequency at each output is half of that of the preceding one. The state of the counter advances on the negative-going edge of the Osc In. The active-high Reset is asynchronous and disables the oscillator to allow very low power consumption during stand-by operation.

State changes of the Q outputs do not occur simultaneously because of internal ripple delays. Therefore, decoded output signals are subject to decoding spikes and may have to be gated with Osc Out 2 of the HC4060A.

Features

- Output Drive Capability: 10 LSTTL Loads
- Outputs Directly Interface to CMOS, NMOS, and TTL
- Operating Voltage Range: 2.0 to 6.0 V
- Low Input Current: 1 μ A
- High Noise Immunity Characteristic of CMOS Devices
- In Compliance With JEDEC Standard No. 7A Requirements
- Chip Complexity: 390 FETs or 97.5 Equivalent Gates
- Pb-Free Packages are Available*



ON Semiconductor®

<http://onsemi.com>

MARKING DIAGRAMS

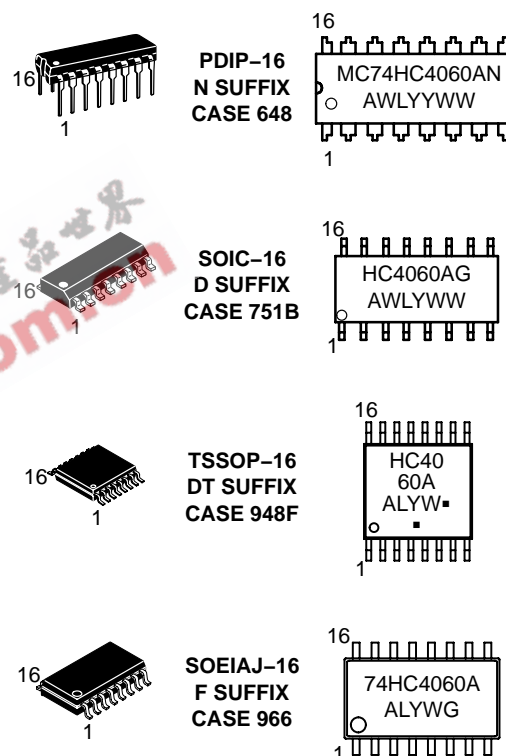

A = Assembly Location
L, WL = Wafer Lot
Y, YY = Year
W, WW = Work Week
G = Pb-Free Package
▪ = Pb-Free Package
(Note: Microdot may be in either location)

ORDERING INFORMATION

See detailed ordering and shipping information in the package dimensions section on page 2 of this data sheet.

*For additional information on our Pb-Free strategy and soldering details, please download the ON Semiconductor Soldering and Mounting Techniques Reference Manual, SOLDERRM/D.

MC74HC4060A

FUNCTION TABLE

Clock	Reset	Output State
	L	No Change
	L	Advance to Next State
X	H	All Outputs Are Low

LOGIC DIAGRAM

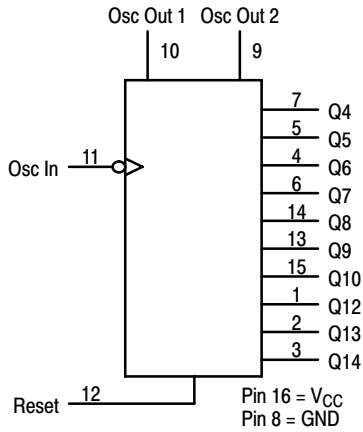

Pinout: 16-Lead Plastic Package (Top View)

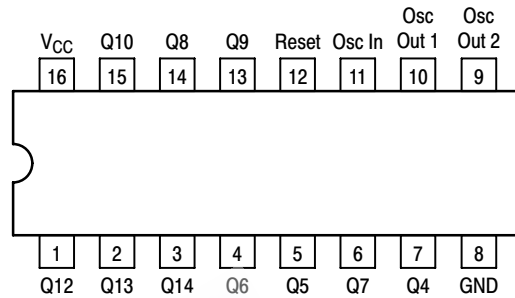

ORDERING INFORMATION

Device	Package	Shipping [†]
MC74HC4060AN	PDIP-16	500 Units / Box
MC74HC4060ANG	PDIP-16 (Pb-Free)	500 Units / Box
MC74HC4060AD	SOIC-16	48 Units / Rail
MC74HC4060ADG	SOIC-16 (Pb-Free)	48 Units / Rail
MC74HC4060ADR2	SOIC-16	2500 Units / Reel
MC74HC4060ADR2G	SOIC-16 (Pb-Free)	2500 Units / Reel
MC74HC4060ADT	TSSOP-16*	96 Units / Rail
MC74HC4060ADTG	TSSOP-16*	96 Units / Rail
MC74HC4060ADTR2	TSSOP-16*	2500 Units / Reel
MC74HC4060ADTR2G	TSSOP-16*	2500 Units / Reel
MC74HC4060AFEL	SOEIAJ-16	2000 Units / Reel
MC74HC4060AFELG	SOEIAJ-16 (Pb-Free)	2000 Units / Reel

[†]For information on tape and reel specifications, including part orientation and tape sizes, please refer to our Tape and Reel Packaging Specifications Brochure, BRD8011/D.

*This package is inherently Pb-Free.

MC74HC4060A

MAXIMUM RATINGS

Symbol	Parameter	Value	Unit
V_{CC}	DC Supply Voltage (Referenced to GND)	- 0.5 to + 7.0	V
V_{in}	DC Input Voltage (Referenced to GND)	- 0.5 to $V_{CC} + 0.5$	V
V_{out}	DC Output Voltage (Referenced to GND)	- 0.5 to $V_{CC} + 0.5$	V
I_{in}	DC Input Current, per Pin	± 20	mA
I_{out}	DC Output Current, per Pin	± 25	mA
I_{CC}	DC Supply Current, V_{CC} and GND Pins	± 50	mA
P_D	Power Dissipation in Still Air, Plastic DIP† SOIC Package† TSSOP Package†	750 500 450	mW
T_{stg}	Storage Temperature Range	- 65 to + 150	°C
T_L	Lead Temperature, 1 mm from Case for 10 Seconds Plastic DIP, SOIC or TSSOP Package	260	°C

This device contains protection circuitry to guard against damage due to high static voltages or electric fields. However, precautions must be taken to avoid applications of any voltage higher than maximum rated voltages to this high-impedance circuit. For proper operation, V_{in} and V_{out} should be constrained to the range $GND \leq (V_{in} \text{ or } V_{out}) \leq V_{CC}$. Unused inputs must always be tied to an appropriate logic voltage level (e.g., either GND or V_{CC}). Unused outputs must be left open.

Maximum ratings are those values beyond which device damage can occur. Maximum ratings applied to the device are individual stress limit values (not normal operating conditions) and are not valid simultaneously. If these limits are exceeded, device functional operation is not implied, damage may occur and reliability may be affected.

†Derating — Plastic DIP: - 10 mW/°C from 65° to 125°C
SOIC Package: - 7 mW/°C from 65° to 125°C
TSSOP Package: - 6.1 mW/°C from 65° to 125°C

For high frequency or heavy load considerations, see Chapter 2 of the ON Semiconductor High-Speed CMOS Data Book (DL129/D).

RECOMMENDED OPERATING CONDITIONS

Symbol	Parameter	Min	Max	Unit
V_{CC}	DC Supply Voltage (Referenced to GND)	2.5*	6.0	V
V_{in}, V_{out}	DC Input Voltage, Output Voltage (Referenced to GND)	0	V_{CC}	V
T_A	Operating Temperature Range, All Package Types	- 55	+ 125	°C
t_r, t_f	Input Rise/Fall Time (Figure 1)			ns
	$V_{CC} = 2.0 \text{ V}$	0	1000	
	$V_{CC} = 4.5 \text{ V}$	0	500	
	$V_{CC} = 6.0 \text{ V}$	0	400	

*The oscillator is guaranteed to function at 2.5 V minimum. However, parametrics are tested at 2.0 V by driving Pin 11 with an external clock source.

DC CHARACTERISTICS (Voltages Referenced to GND)

Symbol	Parameter	Condition	V_{CC} V	Guaranteed Limit			Unit
				-55 to 25°C	≤85°C	≤125°C	
V_{IH}	Minimum High-Level Input Voltage	$V_{out} = 0.1V \text{ or } V_{CC} - 0.1V$ $ I_{out} \leq 20\mu A$	2.0	1.50	1.50	1.50	V
			3.0	2.10	2.10	2.10	
			4.5	3.15	3.15	3.15	
			6.0	4.20	4.20	4.20	
V_{IL}	Maximum Low-Level Input Voltage	$V_{out} = 0.1V \text{ or } V_{CC} - 0.1V$ $ I_{out} \leq 20\mu A$	2.0	0.50	0.50	0.50	V
			3.0	0.90	0.90	0.90	
			4.5	1.35	1.35	1.35	
			6.0	1.80	1.80	1.80	
V_{OH}	Minimum High-Level Output Voltage (Q4-Q10, Q12-Q14)	$V_{in} = V_{IH} \text{ or } V_{IL}$ $ I_{out} \leq 20\mu A$	2.0	1.9	1.9	1.9	V
			4.5	4.4	4.4	4.4	
			6.0	5.9	5.9	5.9	
		$V_{in} = V_{IH} \text{ or } V_{IL}$ $ I_{out} \leq 2.4mA$ $ I_{out} \leq 4.0mA$ $ I_{out} \leq 5.2mA$	3.0	2.48	2.34	2.20	
			4.5	3.98	3.84	3.70	
			6.0	5.48	5.34	5.20	

MC74HC4060A

DC CHARACTERISTICS (Voltages Referenced to GND)

Symbol	Parameter	Condition	V _{CC} V	Guaranteed Limit			Unit
				-55 to 25°C	≤85°C	≤125°C	
V _{OL}	Maximum Low-Level Output Voltage (Q4–Q10, Q12–Q14)	V _{in} = V _{IH} or V _{IL} I _{out} ≤ 20μA	2.0	0.1	0.1	0.1	V
			4.5	0.1	0.1	0.1	
			6.0	0.1	0.1	0.1	
		V _{in} = V _{IH} or V _{IL} I _{out} ≤ 2.4mA I _{out} ≤ 4.0mA I _{out} ≤ 5.2mA	3.0	0.26	0.33	0.40	
			4.5	0.26	0.33	0.40	
			6.0	0.26	0.33	0.40	
V _{OH}	Minimum High-Level Output Voltage (Osc Out 1, Osc Out 2)	V _{in} = V _{CC} or GND I _{out} ≤ 20μA	2.0	1.9	1.9	1.9	V
			4.5	4.4	4.4	4.4	
			6.0	5.9	5.9	5.9	
		V _{in} = V _{CC} or GND I _{out} ≤ 0.7mA I _{out} ≤ 1.0mA I _{out} ≤ 1.3mA	3.0	2.48	2.34	2.20	
			4.5	3.98	3.84	3.70	
			6.0	5.48	5.34	5.20	
V _{OL}	Maximum Low-Level Output Voltage (Osc Out 1, Osc Out 2)	V _{in} = V _{CC} or GND I _{out} ≤ 20μA	2.0	0.1	0.1	0.1	V
			4.5	0.1	0.1	0.1	
			6.0	0.1	0.1	0.1	
		V _{in} = V _{CC} or GND I _{out} ≤ 0.7mA I _{out} ≤ 1.0mA I _{out} ≤ 1.3mA	3.0	0.26	0.33	0.40	
			4.5	0.26	0.33	0.40	
			6.0	0.26	0.33	0.40	
I _{in}	Maximum Input Leakage Current	V _{in} = V _{CC} or GND	6.0	±0.1	±1.0	±1.0	μA
I _{CC}	Maximum Quiescent Supply Current (per Package)	V _{in} = V _{CC} or GND I _{out} = 0μA	6.0	4	40	160	μA

NOTE: Information on typical parametric values can be found in Chapter 2 of the ON Semiconductor High-Speed CMOS Data Book (DL129/D).

AC CHARACTERISTICS (C_L = 50 pF, Input t_r = t_f = 6 ns)

Symbol	Parameter	V _{CC} V	Guaranteed Limit			Unit
			-55 to 25°C	≤85°C	≤125°C	
f _{max}	Maximum Clock Frequency (50% Duty Cycle) (Figures 1 and 4)	2.0	6.0	9.0	8.0	MHz
		3.0	10	14	12	
		4.5	30	28	25	
		6.0	50	45	40	
t _{PLH} , t _{PHL}	Maximum Propagation Delay, Osc In to Q4* (Figures 1 and 4)	2.0	300	375	450	ns
		3.0	180	200	250	
		4.5	60	75	90	
		6.0	51	64	75	
t _{PLH} , t _{PHL}	Maximum Propagation Delay, Osc In to Q14* (Figures 1 and 4)	2.0	500	750	1000	ns
		3.0	350	450	600	
		4.5	250	275	300	
		6.0	200	220	250	
t _{PHL}	Maximum Propagation Delay, Reset to Any Q (Figures 2 and 4)	2.0	195	245	300	ns
		3.0	75	100	125	
		4.5	39	49	61	
		6.0	33	42	53	
t _{PLH} , t _{PHL}	Maximum Propagation Delay, Q _n to Q _{n+1} (Figures 3 and 4)	2.0	75	95	125	ns
		3.0	60	75	95	
		4.5	15	19	24	
		6.0	13	16	20	

MC74HC4060A

AC CHARACTERISTICS ($C_L = 50$ pF, Input $t_r = t_f = 6$ ns) – continued

Symbol	Parameter	V _{CC} V	Guaranteed Limit			Unit
			-55 to 25°C	≤85°C	≤125°C	
t _{TLH} , t _{THL}	Maximum Output Transition Time, Any Output (Figures 1 and 4)	2.0	75	95	110	ns
		3.0	27	32	36	
		4.5	15	19	22	
		6.0	13	16	19	
C _{in}	Maximum Input Capacitance		10	10	10	pF

NOTE: For propagation delays with loads other than 50 pF, and information on typical parametric values, see Chapter 2 of the ON Semiconductor High-Speed CMOS Data Book (DL129/D).

* For T_A = 25°C and C_L = 50 pF, typical propagation delay from Clock to other Q outputs may be calculated with the following equations:

$$V_{CC} = 2.0 \text{ V: } t_P = [93.7 + 59.3 (n-1)] \text{ ns}$$

$$V_{CC} = 4.5 \text{ V: } t_P = [30.25 + 14.6 (n-1)] \text{ ns}$$

$$V_{CC} = 3.0 \text{ V: } t_P = [61.5 + 34.4 (n-1)] \text{ ns}$$

$$V_{CC} = 6.0 \text{ V: } t_P = [24.4 + 12 (n-1)] \text{ ns}$$

Symbol	Parameter	Typical @ 25°C, V _{CC} = 5.0 V		Unit
		35		
C _{PD}	Power Dissipation Capacitance (Per Package)*			pF

* Used to determine the no-load dynamic power consumption: $P_D = C_{PD} V_{CC}^2 f + I_{CC} V_{CC}$. For load considerations, see Chapter 2 of the ON Semiconductor High-Speed CMOS Data Book (DL129/D).

TIMING REQUIREMENTS (Input $t_r = t_f = 6$ ns)

Symbol	Parameter	V _{CC} V	Guaranteed Limit			Unit
			-55 to 25°C	≤85°C	≤125°C	
t _{rec}	Minimum Recovery Time, Reset Inactive to Clock (Figure 2)	2.0	100	125	150	ns
		3.0	75	100	120	
		4.5	20	25	30	
		6.0	17	21	25	
t _w	Minimum Pulse Width, Clock (Figure 1)	2.0	75	95	110	ns
		3.0	27	32	36	
		4.5	15	19	23	
		6.0	13	16	19	
t _w	Minimum Pulse Width, Reset (Figure 2)	2.0	75	95	110	ns
		3.0	27	32	36	
		4.5	15	19	23	
		6.0	13	16	19	
t _r , t _f	Maximum Input Rise and Fall Times (Figure 1)	2.0	1000	1000	1000	ns
		3.0	800	800	800	
		4.5	500	500	500	
		6.0	400	400	400	

NOTE: Information on typical parametric values can be found in Chapter 2 of the ON Semiconductor High-Speed CMOS Data Book (DL129/D).

MC74HC4060A

PIN DESCRIPTIONS

INPUTS

Osc In (Pin 11)

Negative-edge triggering clock input. A high-to-low transition on this input advances the state of the counter. Osc In may be driven by an external clock source.

Reset (Pin 12)

Active-high reset. A high level applied to this input asynchronously resets the counter to its zero state (forcing all Q outputs low) and disables the oscillator.

OUTPUTS

Q4—Q10, Q12—Q14 (Pins 7, 5, 4, 6, 13, 15, 1, 2, 3)

Active-high outputs. Each Qn output divides the Clock input frequency by 2^N . The user should note the Q1, Q2, Q3 and Q11 are not available as outputs.

Osc Out 1, Osc Out 2 (Pins 9, 10)

Oscillator outputs. These pins are used in conjunction with Osc In and the external components to form an oscillator. When Osc In is being driven with an external clock source, Osc Out 1 and Osc Out 2 must be left open circuited. With the crystal oscillator configuration in Figure 6, Osc Out 2 must be left open circuited.

SWITCHING WAVEFORMS

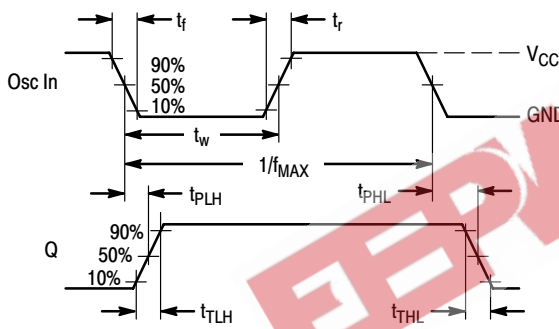

Figure 1.

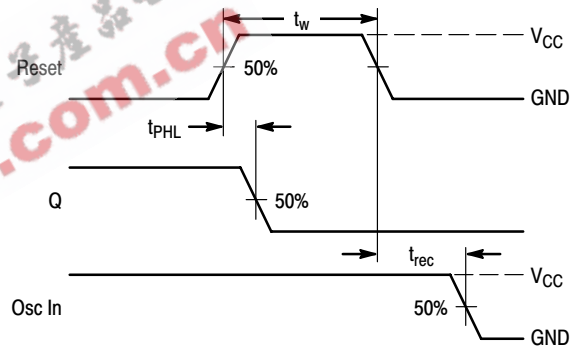

Figure 2.

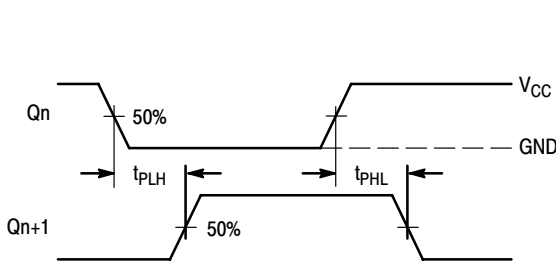
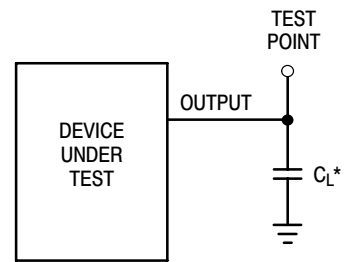

Figure 3.



*Includes all probe and jig capacitance

Figure 4. Test Circuit

MC74HC4060A

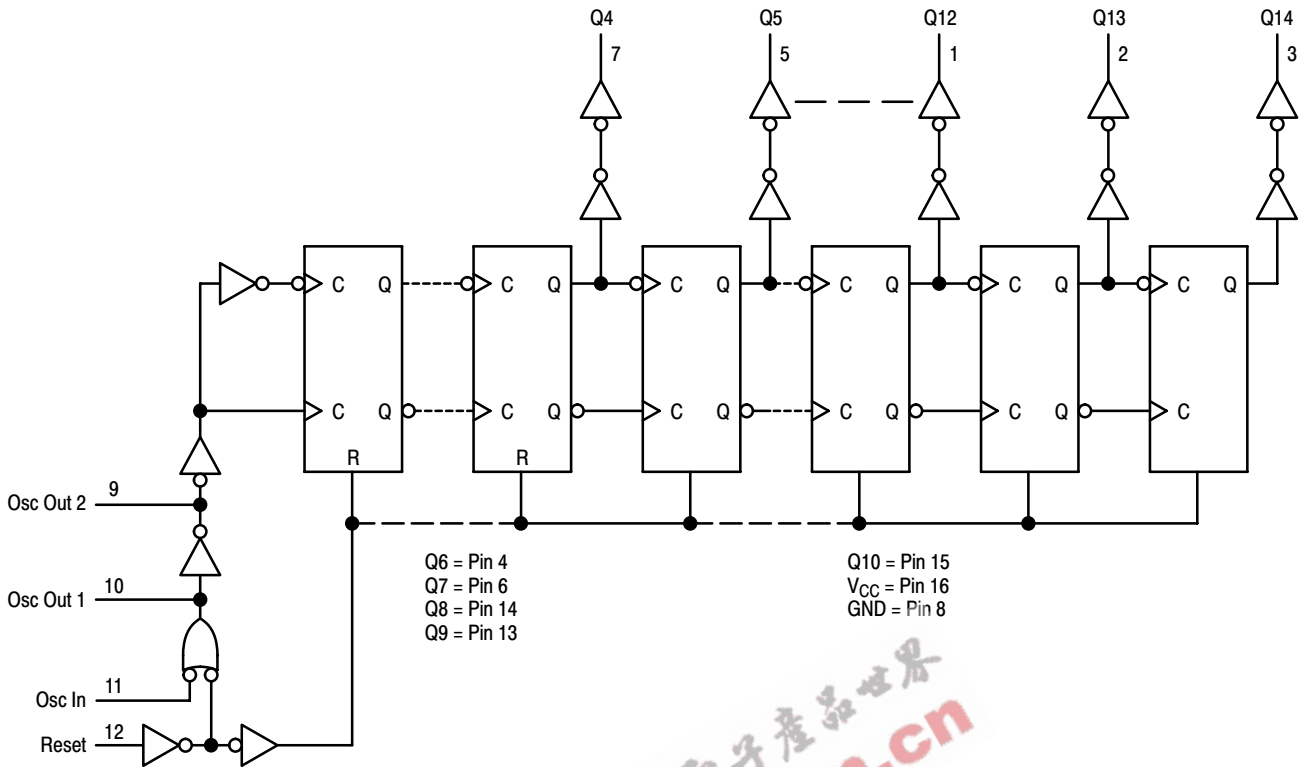
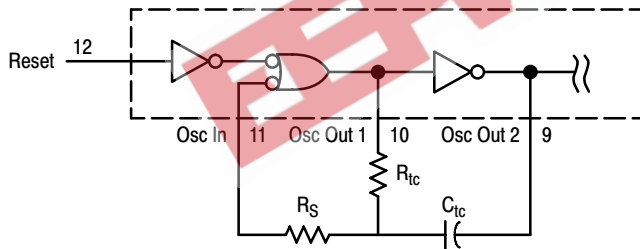

Figure 5. Expanded Logic Diagram



For $2.0V \leq V_{CC} \leq 6.0V$
 $10R_{Tc} > R_S > 2R_{Tc}$
 $400Hz \leq f \leq 400KHz$:

$$f \approx \frac{1}{3 R_{Tc} C_{Tc}} \text{ (f in Hz, } R_{Tc} \text{ in ohms, } C_{Tc} \text{ in farads)}$$

The formula may vary for other frequencies.

Figure 6. Oscillator Circuit Using RC Configuration

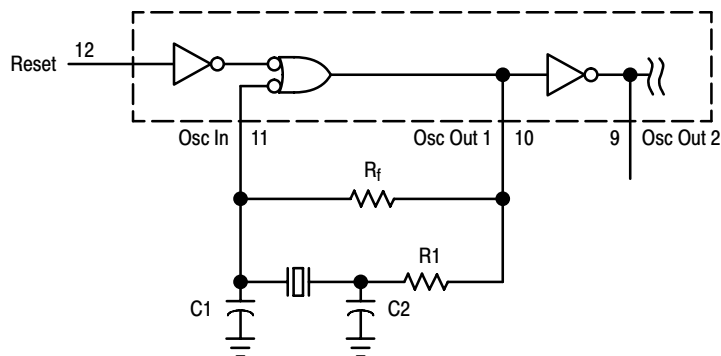

Figure 7. Pierce Crystal Oscillator Circuit

MC74HC4060A

TABLE 1. CRYSTAL OSCILLATOR AMPLIFIER SPECIFICATIONS ($T_A = 25^\circ\text{C}$; Input = Pin 11, Output = Pin 10)

Type	Positive Reactance (Pierce)	
Input Resistance, R_{in}	60M Ω Minimum	
Output Impedance, Z_{out} (4.5V Supply)	200 Ω (See Text)	
Input Capacitance, C_{in}	5pF Typical	
Output Capacitance, C_{out}	7pF Typical	
Series Capacitance, C_a	5pF Typical	
Open Loop Voltage Gain with Output at Full Swing, α	3Vdc Supply	5.0 Expected Minimum
	4Vdc Supply	4.0 Expected Minimum
	5Vdc Supply	3.3 Expected Minimum
	6Vdc Supply	3.1 Expected Minimum

PIERCE CRYSTAL OSCILLATOR DESIGN

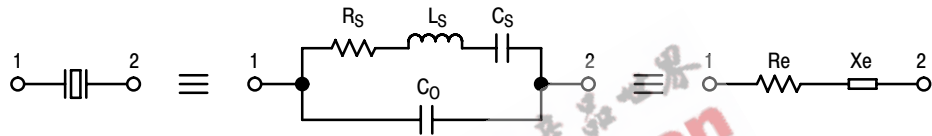

Value are supplied by crystal manufacturer (parallel resonant crystal).

Figure 8. Equivalent Crystal Networks

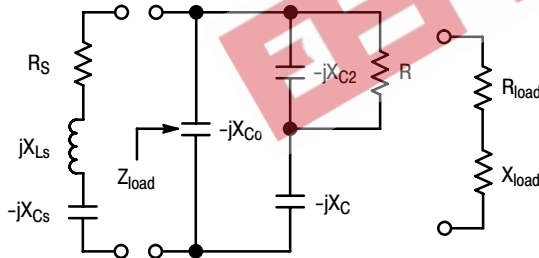

NOTE: $C = C_1 + C_{in}$ and $R = R_1 + R_{out}$. C_0 is considered as part of the load. C_a and R_f typically have minimal effect below 2MHz.

Figure 9. Series Equivalent Crystal Load

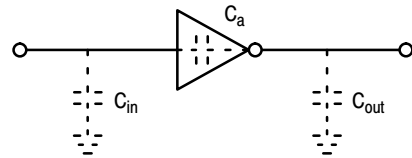

Values are listed in Table 1.

Figure 10. Parasitic Capacitances of the Amplifier

MC74HC4060A

DESIGN PROCEDURES

The following procedure applies for oscillators operating below 2MHz where Z is a resistor R1. Above 2MHz, additional impedance elements should be considered: C_{out} and C_a of the amp, feedback resistor R_f, and amplifier phase shift error from 180°C.

Step 1: Calculate the equivalent series circuit of the crystal at the frequency of oscillation.

$$Z_e = \frac{-jX_{C_0}(R_s + jX_{L_s} - jX_{C_s})}{-jX_{C_0} + R_s + jX_{L_s} - jX_{C_s}} = R_e + jX_e$$

Reactance jX_e should be positive, indicating that the crystal is operating as an inductive reactance at the oscillation frequency. The maximum R_s for the crystal should be used in the equation.

Step 2: Determine β, the attenuation, of the feedback network. For a closed-loop gain of 2, A_vβ = 2, β = 2/A_v where A_v is the gain of the HC4060A amplifier.

Step 3: Determine the manufacturer's loading capacitance. For example: A manufacturer may specify an external load capacitance of 32pF at the required frequency.

Step 4: Determine the required Q of the system, and calculate R_{load}. For example, a manufacturer specifies a crystal Q of 100,000. In-circuit Q is arbitrarily set at 20% below crystal Q or 80,000. Then R_{load} = (2πf_oL_s/Q) - R_s where L_s and R_s are crystal parameters.

Step 5: Simultaneously solve, using a computer,

$$\beta = \frac{X_C \cdot X_{C_2}}{R \cdot R_e + X_{C_2}(X_e - X_C)} \quad (\text{with feedback phase shift} = 180^\circ) \quad (\text{Eq 1})$$

$$X_e = X_{C_2} + X_C + \frac{R_e X_{C_2}}{R} = X_{C_{load}} \quad (\text{where the loading capacitor is an external load, not including } C_0) \quad (\text{Eq 2})$$

$$R_{load} = \frac{R X_{C_0} X_{C_2} [(X_C + X_{C_2})(X_C + X_{C_0}) - X_C(X_C + X_{C_0} + X_{C_2})]}{X^2_{C_2}(X_C + X_{C_0})^2 + R^2(X_C + X_{C_0} + X_{C_2})^2} \quad (\text{Eq 3})$$

Here R = R_{out} + R1. R_{out} is amp output resistance, R1 is Z. The C corresponding to X_C is given by C = C1 + C_{in}.

Alternately, pick a value for R1 (i.e. let R1 = R_s). Solve Equations 1 and 2 for C1 and C2. Use Equation 3 and the fact that Q = 2πf_oL_s/(R_s + R_{load}) to find in-circuit Q. If Q is not satisfactory pick another value for R1 and repeat the procedure.

CHOOSING R1

Power is dissipated in the effective series resistance of the crystal. The drive level specified by the crystal manufacturer is the maximum stress that a crystal can withstand without damage or excessive shift in frequency. R1 limits the drive level.

To verify that the maximum dc supply voltage does not overdrive the crystal, monitor the output frequency as a function of voltage at Osc Out 2 (Pin 9). The frequency should increase very slightly as the dc supply voltage is increased. An overdriven crystal will decrease in frequency or become unstable with an increase in supply voltage. The operating supply voltage must be reduced or R1 must be increased in value if the overdriven condition exists. The user should note that the oscillator start-up time is proportional to the value of R1.

SELECTING R_f

The feedback resistor, R_f, typically ranges up to 20MΩ. R_f determines the gain and bandwidth of the amplifier. Proper bandwidth insures oscillation at the correct frequency plus roll-off to minimize gain at undesirable frequencies, such as

the first overtone. R_f must be large enough so as to not affect the phase of the feedback network in an appreciable manner.

ACKNOWLEDGEMENTS AND RECOMMENDED REFERENCES

The following publications were used in preparing this data sheet and are hereby acknowledged and recommended for reading:

Technical Note TN-24, Statek Corp.

Technical Note TN-7, Statek Corp.

D. Babin, "Designing Crystal Oscillators", Machine Design, March 7, 1985.

D. Babin, "Guidelines for Crystal Oscillator Design", Machine Design, April 25, 1985.

ALSO RECOMMENDED FOR READING:

E. Hafner, "The Piezoelectric Crystal Unit-Definitions and Method of Measurement", Proc. IEEE, Vol. 57, No. 2, Feb., 1969.

D. Kemper, L. Rosine, "Quartz Crystals for Frequency Control", Electro-Technology, June, 1969.

P. J. Ottowitz, "A Guide to Crystal Selection", Electronic Design, May, 1966.

MC74HC4060A

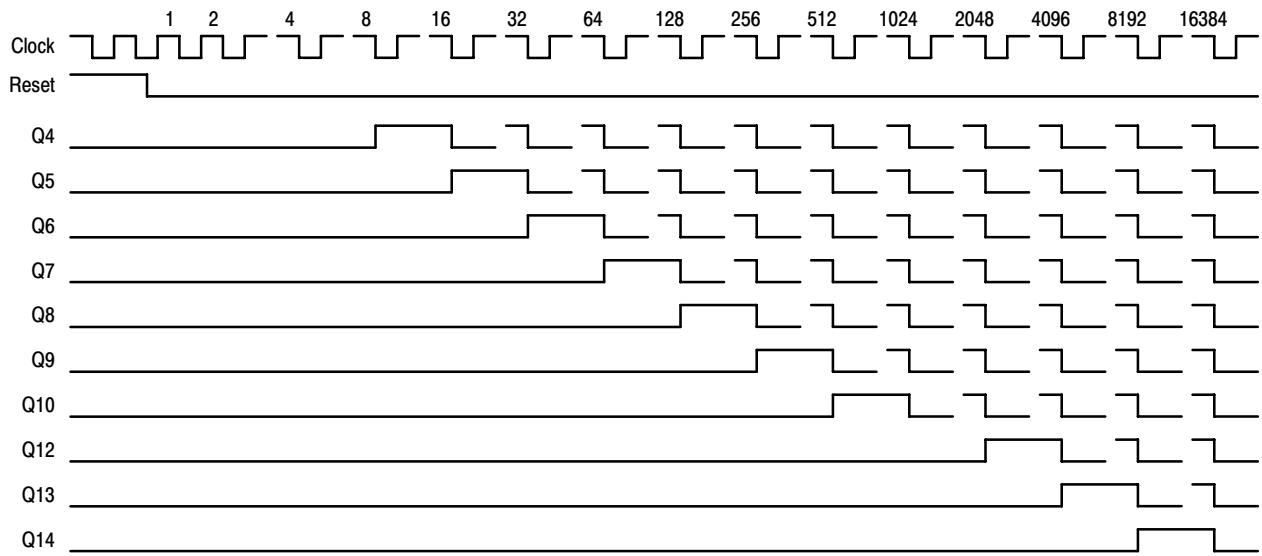

Figure 11. Timing Diagram

EEPW 电子产品世界 .com.cn

MC74HC4060A

PACKAGE DIMENSIONS

PDIP-16
N SUFFIX
CASE 648-08
ISSUE T

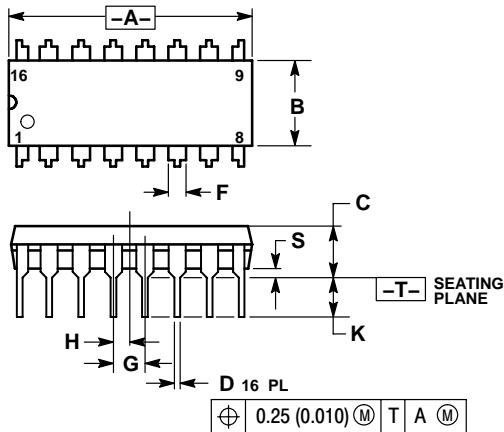

- NOTES:
1. DIMENSIONING AND TOLERANCING PER ANSI Y14.5M, 1982.
 2. CONTROLLING DIMENSION: INCH.
 3. DIMENSION L TO CENTER OF LEADS WHEN FORMED PARALLEL.
 4. DIMENSION B DOES NOT INCLUDE MOLD FLASH.
 5. ROUNDED CORNERS OPTIONAL.

DIM	INCHES		MILLIMETERS	
	MIN	MAX	MIN	MAX
A	0.740	0.770	18.80	19.55
B	0.250	0.270	6.35	6.85
C	0.145	0.175	3.69	4.44
D	0.015	0.021	0.39	0.53
F	0.040	0.70	1.02	1.77
G	0.100 BSC		2.54 BSC	
H	0.050 BSC		1.27 BSC	
J	0.008	0.015	0.21	0.38
K	0.110	0.130	2.80	3.30
L	0.295	0.305	7.50	7.74
M	0°	10°	0°	10°
S	0.020	0.040	0.51	1.01

SOIC-16
D SUFFIX
CASE 751B-05
ISSUE J

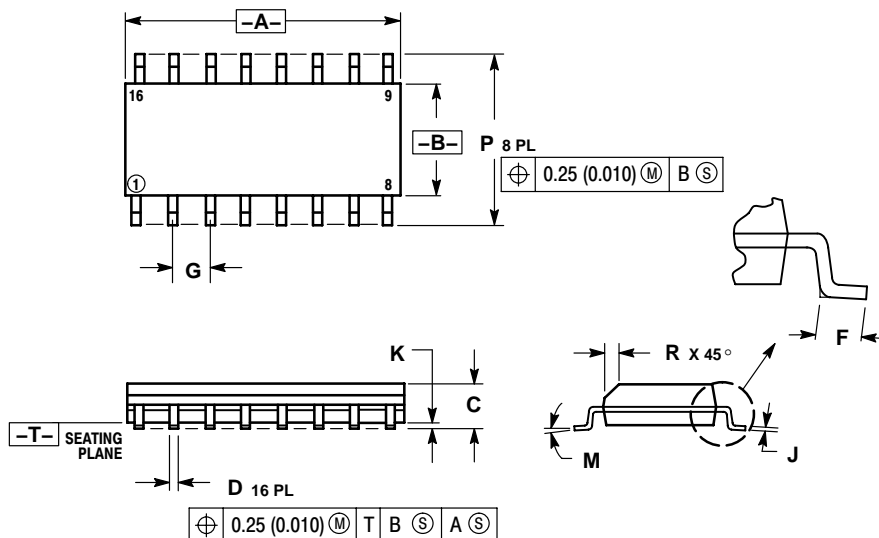

- NOTES:
1. DIMENSIONING AND TOLERANCING PER ANSI Y14.5M, 1982.
 2. CONTROLLING DIMENSION: MILLIMETER.
 3. DIMENSIONS A AND B DO NOT INCLUDE MOLD PROTRUSION.
 4. MAXIMUM MOLD PROTRUSION 0.15 (0.006) PER SIDE.
 5. DIMENSION D DOES NOT INCLUDE DAMBAR PROTRUSION. ALLOWABLE DAMBAR PROTRUSION SHALL BE 0.127 (0.005) TOTAL IN EXCESS OF THE D DIMENSION AT MAXIMUM MATERIAL CONDITION.

DIM	MILLIMETERS		INCHES	
	MIN	MAX	MIN	MAX
A	9.80	10.00	0.386	0.393
B	3.80	4.00	0.150	0.157
C	1.35	1.75	0.054	0.068
D	0.35	0.49	0.014	0.019
F	0.40	1.25	0.016	0.049
G	1.27 BSC		0.050 BSC	
J	0.19	0.25	0.008	0.009
K	0.10	0.25	0.004	0.009
M	0°	7°	0°	7°
P	5.80	6.20	0.229	0.244
R	0.25	0.50	0.010	0.019

MC74HC4060A

PACKAGE DIMENSIONS

TSSOP-16
DT SUFFIX
CASE 948F-01
ISSUE A

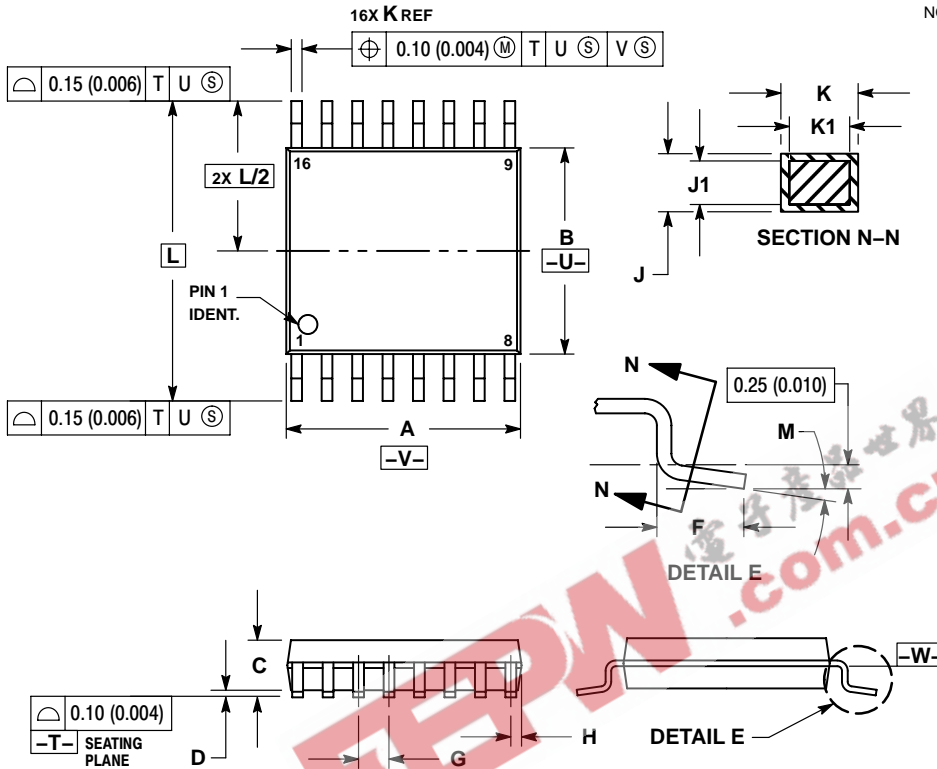

NOTES:

1. DIMENSIONING AND TOLERANCING PER ANSI Y14.5M, 1982.
2. CONTROLLING DIMENSION: MILLIMETER.
3. DIMENSION A DOES NOT INCLUDE MOLD FLASH, PROTRUSIONS OR GATE BURRS. MOLD FLASH OR GATE BURRS SHALL NOT EXCEED 0.15 (0.006) PER SIDE.
4. DIMENSION B DOES NOT INCLUDE INTERLEAD FLASH OR PROTRUSION. INTERLEAD FLASH OR PROTRUSION SHALL NOT EXCEED 0.25 (0.010) PER SIDE.
5. DIMENSION K DOES NOT INCLUDE DAMBAR PROTRUSION. ALLOWABLE DAMBAR PROTRUSION SHALL BE 0.08 (0.003) TOTAL IN EXCESS OF THE K DIMENSION AT MAXIMUM MATERIAL CONDITION.
6. TERMINAL NUMBERS ARE SHOWN FOR REFERENCE ONLY.
7. DIMENSION A AND B ARE TO BE DETERMINED AT DATUM PLANE -W-.

DIM	MILLIMETERS		INCHES	
	MIN	MAX	MIN	MAX
A	4.90	5.10	0.193	0.200
B	4.30	4.50	0.169	0.177
C	---	1.20	---	0.047
D	0.05	0.15	0.002	0.006
F	0.50	0.75	0.020	0.030
G	0.65 BSC		0.026 BSC	
H	0.18	0.28	0.007	0.011
J	0.09	0.20	0.004	0.008
J1	0.09	0.16	0.004	0.006
K	0.19	0.30	0.007	0.012
K1	0.19	0.25	0.007	0.010
L	6.40 BSC		0.252 BSC	
M	0°	8°	0°	8°

MC74HC4060A

PACKAGE DIMENSIONS

SOEIAJ-16
F SUFFIX

CASE 966-01

ISSUE O

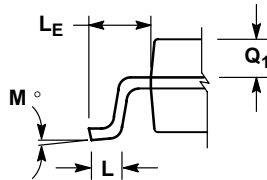
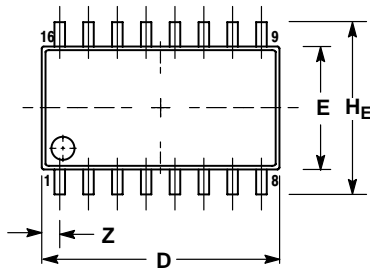

DETAIL P

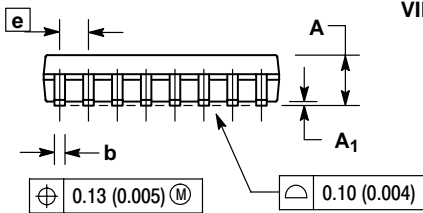

VIEW P

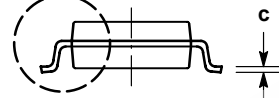

NOTES:

1. DIMENSIONING AND TOLERANCING PER ANSI Y14.5M, 1982.
2. CONTROLLING DIMENSION: MILLIMETER.
3. DIMENSIONS D AND E DO NOT INCLUDE MOLD FLASH OR PROTRUSIONS AND ARE MEASURED AT THE PARTING LINE. MOLD FLASH OR PROTRUSIONS SHALL NOT EXCEED 0.15 (0.006) PER SIDE.
4. TERMINAL NUMBERS ARE SHOWN FOR REFERENCE ONLY.
5. THE LEAD WIDTH DIMENSION (b) DOES NOT INCLUDE DAMBAR PROTRUSION. ALLOWABLE DAMBAR PROTRUSION SHALL BE 0.08 (0.003) TOTAL IN EXCESS OF THE LEAD WIDTH DIMENSION AT MAXIMUM MATERIAL CONDITION. DAMBAR CANNOT BE LOCATED ON THE LOWER RADIUS OR THE FOOT. MINIMUM SPACE BETWEEN PROTRUSIONS AND ADJACENT LEAD TO BE 0.46 (0.018).

DIM	MILLIMETERS		INCHES	
	MIN	MAX	MIN	MAX
A	---	2.05	---	0.081
A ₁	0.05	0.20	0.002	0.008
b	0.35	0.50	0.014	0.020
c	0.18	0.27	0.007	0.011
D	9.90	10.50	0.390	0.413
E	5.10	5.45	0.201	0.215
e	1.27 BSC		0.050 BSC	
H _E	7.40	8.20	0.291	0.323
L	0.50	0.85	0.020	0.033
L _E	1.10	1.50	0.043	0.059
M	0°	10°	0°	10°
Q ₁	0.70	0.90	0.028	0.035
Z	---	0.78	---	0.031

MC74HC4060A

EEPW 电子产品世界
.com.cn

ON Semiconductor and  are registered trademarks of Semiconductor Components Industries, LLC (SCILLC). SCILLC reserves the right to make changes without further notice to any products herein. SCILLC makes no warranty, representation or guarantee regarding the suitability of its products for any particular purpose, nor does SCILLC assume any liability arising out of the application or use of any product or circuit, and specifically disclaims any and all liability, including without limitation special, consequential or incidental damages. "Typical" parameters which may be provided in SCILLC data sheets and/or specifications can and do vary in different applications and actual performance may vary over time. All operating parameters, including "Typicals" must be validated for each customer application by customer's technical experts. SCILLC does not convey any license under its patent rights nor the rights of others. SCILLC products are not designed, intended, or authorized for use as components in systems intended for surgical implant into the body, or other applications intended to support or sustain life, or for any other application in which the failure of the SCILLC product could create a situation where personal injury or death may occur. Should Buyer purchase or use SCILLC products for any such unintended or unauthorized application, Buyer shall indemnify and hold SCILLC and its officers, employees, subsidiaries, affiliates, and distributors harmless against all claims, costs, damages, and expenses, and reasonable attorney fees arising out of, directly or indirectly, any claim of personal injury or death associated with such unintended or unauthorized use, even if such claim alleges that SCILLC was negligent regarding the design or manufacture of the part. SCILLC is an Equal Opportunity/Affirmative Action Employer. This literature is subject to all applicable copyright laws and is not for resale in any manner.

PUBLICATION ORDERING INFORMATION

LITERATURE FULFILLMENT:

Literature Distribution Center for ON Semiconductor
P.O. Box 61312, Phoenix, Arizona 85082-1312 USA
Phone: 480-829-7710 or 800-344-3860 Toll Free USA/Canada
Fax: 480-829-7709 or 800-344-3867 Toll Free USA/Canada
Email: orderlit@onsemi.com

N. American Technical Support: 800-282-9855 Toll Free
USA/Canada

Japan: ON Semiconductor, Japan Customer Focus Center
2-9-1 Kamimeguro, Meguro-ku, Tokyo, Japan 153-0051
Phone: 81-3-5773-3850

ON Semiconductor Website: <http://onsemi.com>

Order Literature: <http://www.onsemi.com/litorder>

For additional information, please contact your
local Sales Representative.

MC74HC4060A/D