

MOTOROLA

Communications and Advanced
Consumer Technologies Group

Order th
M6

M6

Addendum to M68000 User Manual

August 7, 1997

This addendum to the *M68000UM/AD User's Manual*, Revision 8, provides corrections to the o as well as additional information. This document and other information on this product is maintaine Wide Web at <http://www.motorola.com/68000>.

OVERVIEW

This manual includes hardware details and programming information for the MC68HC000, the the MC68EC000, and the MC68SEC000. For ease of reading, the name M68000 MPUs will be referring to all processors. Refer to *M68000PM/AD*, *M68000 Programmer's Reference Manual*, information on the MC68000 instruction set.

The four microprocessors are very similar to each other and all contain the following features:

- Sixteen 32-Bit Data and Address Registers
- 16-Mbyte Direct Addressing Range
- Program Counter
- 6 Instruction Types
- Operations on Five Main Data Types
- Memory-Mapped Input/Output (I/O)
- 14 Addressing Modes

The following processors contain additional features:

- MC68HC001/MC68EC000/MC68SEC000
 - Statically selectable 8- or 16-bit data bus
- MC68HC000/MC68EC000/MC68HC001/MC68SEC000
 - Low power

This document contains information on a product under development. Motorola reserves the right to change or discontinue this product with

SEMICONDUCTOR PRODUCT INFORMATION

© 1997 Motorola, Inc. All Rights Reserved.

The primary features of the MC68SEC000 embedded processor include the following:

- Direct Replacement for the MC68EC000
 - Pin-for-pin compatibility with the MC68EC000 in the plastic QFP and TQFP packages
 - Vast selection of existing third-party development tools for the MC68EC000 support the MC68SEC000
 - Software written for the MC68EC000 will run unchanged on the MC68SEC000
- Power Management
 - Low-power HCMOS technology
 - Static design allows for stopping the processor clock
 - 3.3V or 5V operation
 - Typical 0.5 μ A current consumption at 3.3V in sleep mode
- Software Strength
 - Fully upward object-code compatible with other M68000 Family products
 - M68000 architecture allows effective assembly code with a C compiler
- Upgrade
 - Fully upward code-compatible with higher performance 680x0 and 68300 Family members
 - ColdFire[®] code-compatible with minor modifications

1. MC68HC000

The primary benefit of the MC68HC000 is reduced power consumption. The device dissipates less power (an order of magnitude) than the NMOS MC68000.

The MC68HC000 is an implementation of the M68000 16-/32-bit microprocessor architecture. The MC68HC000 has a 16-bit data bus implementation of the MC68000 and is upward code-compatible with the MC68010 and the MC68020 32-bit implementation of the architecture.

1.1 MC68HC001

The MC68HC001 provides a functional extension to the MC68HC000 HCMOS 16-/32-bit microprocessor with the addition of statically selectable 8- or 16-bit data bus operation. The MC68HC001 is object-code compatible with the MC68HC000. You can migrate code written for the MC68HC001 without modification to any member of the M68000 Family.

1.2 MC68EC000

The MC68EC000 is an economical high-performance embedded controller designed to suit the needs of the cost-sensitive embedded-controller market. The HCMOS MC68EC000 has an internal 32-bit architecture supported by a statically selectable 8- or 16-bit data bus. This architecture provides a fast and efficient processing device that can satisfy the requirements of sophisticated applications based on high-level languages.

The MC68EC000 is fully object-code compatible with the MC68000. You can migrate code written for the MC68EC000 without modification to any member of the M68000 Family.

The MC68EC000 brings the performance level of the M68000 Family to cost levels previously associated with 8-bit microprocessors. The MC68EC000 benefits from the rich M68000 instruction set and its related high density with low memory bandwidth requirements.

1.3 MC68SEC000

The MC68SEC000 is a cost-effective static embedded processor engineered for low-power applications. In addition to providing the substantial cost and performance benefits of the MC68EC000, the low-power MC68SEC000 provides significant advantages in power consumption and power management. The typical current consumption of the MC68SEC000 is only 0.5 μ A in static standby mode and 15.0mA in 3.3V operation. The MC68SEC000 operates in either 3.3V or 5.0V systems. The remarkably low power consumption, small footprint packages, and static implementation are combined in the MC68SEC000 for power applications such as portable measuring equipment, electronic games, and battery-operated handheld consumer products.

The HCMOS MC68SEC000's static architecture is a direct replacement for the MC68EC000, which offers the lowest cost entry point to 32-bit processing. The internal 32-bit architecture provides fast and efficient processing that satisfies the requirements of sophisticated applications based on high-level languages.

All of the existing third-party developer tools widely available for the MC68EC000 will directly support the MC68SEC000. You can find detailed descriptions of these tools in the *High Performance Embedded Source Catalog*.

EFPW 电子產品世界
.com.cn

2.0 SIGNAL DESCRIPTION

Change Figure 3-3 on Page 3-2.

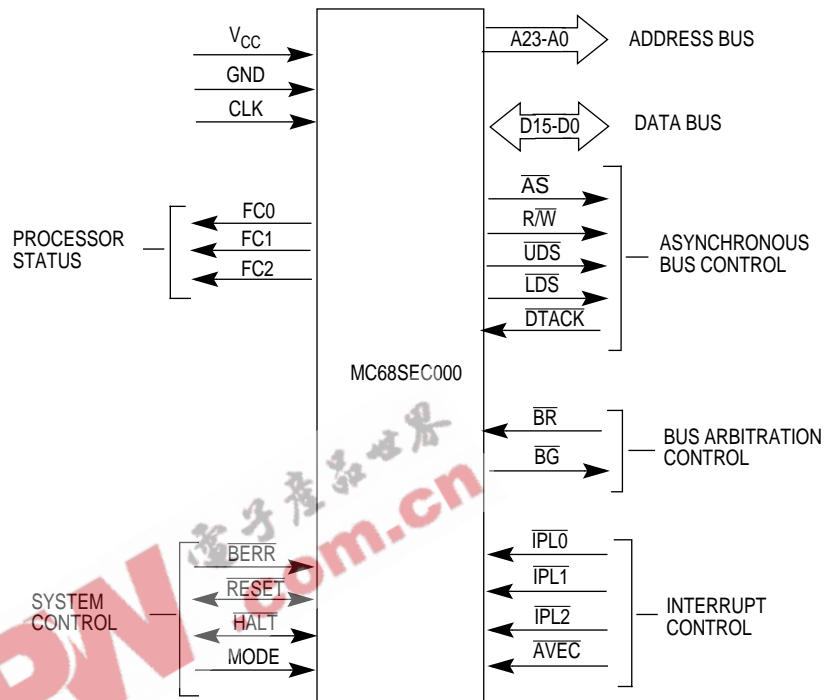

Figure 1. Input and Output Signals (MC68EC000 and MC68SEC000)

2.1 Data Bus (D15-D0)

In Section 3.2 on page 3-4, replace “The MC68EC000 and MC68HC001 use D7-D0 in 8-bit mode, and D8 are undefined.” with “Using the MC68HC001, MC68EC000, and MC68SEC000 mode pin, you statically select either 8- or 16-bit modes for data transfer. The MC68EC000, MC68SEC000, and MC68HC001 use D7-D0 in 8-bit mode. D15-D8 are undefined.”

2.2 Bus Arbitration Control

In Section 3.4 on page 3-5, the sentence “In the 48-pin version of the MC68008 and MC68EC000, no pin is available for the bus grant acknowledge signal; this microprocessor uses a two-wire bus arbitration scheme.” should read “In the 64-pin MC68EC000 and MC68SEC000, no pin is available for the bus grant acknowledge signal. These microprocessors use a two-wire bus arbitration scheme.”

2.3 System Control

The Mode subsection heading of Section 3.6 on page 3-7 should read “Mode (MODE) (MC68HC001/MC68EC000/68SEC000).”

2.4 MC68SEC000 Low-Power Mode

Add the following to Sections 4 and 5, Bus Operation.

The MC68SEC000 has been redesigned to provide fully static- and low-power operation. This section describes the recommended method for placing the MC68SEC000 into a low-power mode to reduce

8-bit mode requires two bus cycles to fetch the immediate data of the STOP instruction. After processor clock is disabled, it is often necessary to disable the clock to other sections of your system. This can be done, but be careful that runt clocks and spurious glitches are not presented to the MC68SEC000. A timing diagram is shown in Figure 4.

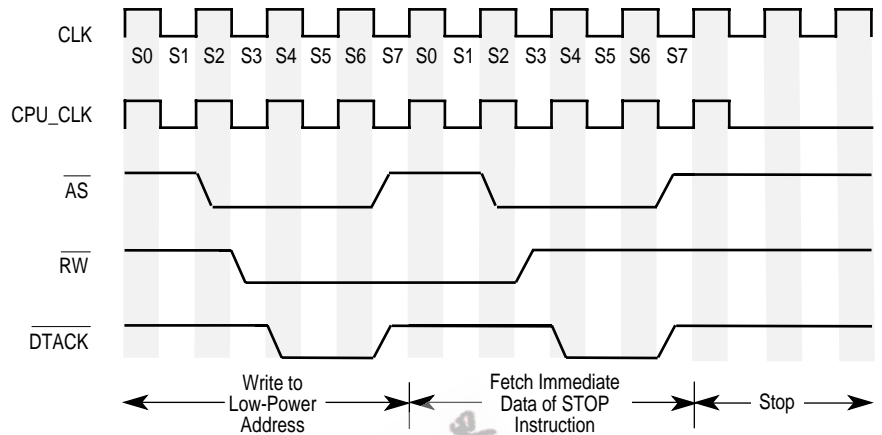

Figure 4. MC68SEC000 Clock Stop Timing for 16-Bit Data Bus

Note: While the MC68SEC000 is in the low-power mode, all inputs must be driven to V_{DD} or V_{SS} , or pull-up or pull-down resistor.

- This step is optional depending on whether your applications require the MC68SEC000 signal three-state capability to be placed into a high-impedance state. To place the MC68SEC000 in a three-state condition, the proper method for arbitrating the bus (as described in 5.2 Bus Arbitration in the *M68000 User's Manual, Rev 8*) should be completed during the fetch of the status register for the STOP instruction. A timing diagram with the bus arbitration sequence is shown in Figure 5.

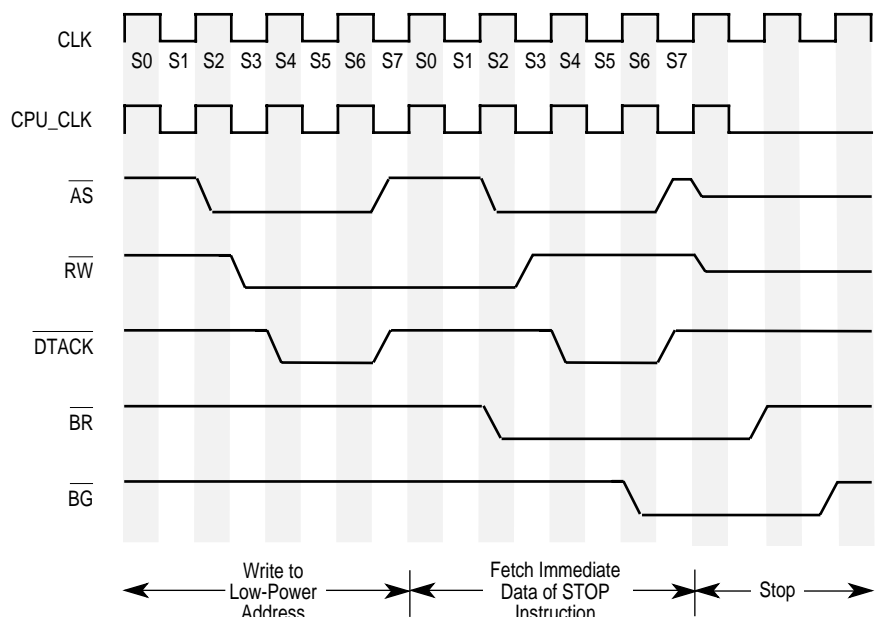

Figure 5. MC68SEC000 Clock Stop Timing with Bus Arbitration for 16-Bit Data Bus

After the previous steps are completed, the MC68SEC000 will remain in the low-power mode until it recognizes the appropriate interrupt. External logic will also have to poll IPLB2–IPLB0 to detect the interrupt. When the correct interrupt level is received, the following steps will bring the processor out of low-power mode:

1. Restart the system clock if it was stopped.
2. Wait for the system clock to become stable.
3. Assert the $\overline{\text{RESTART}}$ signal. This will cause the processor's clock to start on the next falling edge of the system clock. Figure 6 shows the timing for bringing the processor out of the low-power mode. Both the $\overline{\text{RESTART}}$ and $\overline{\text{RESET}}$ signals are subject to the asynchronous setup time as specified in the Electrical Characteristics section of this addendum.

WARNING

The system clock must be stable before the $\overline{\text{RESTART}}$ signal is asserted to prevent glitches in the clock. An unstable clock can cause unpredictable results in the MC68SEC000.

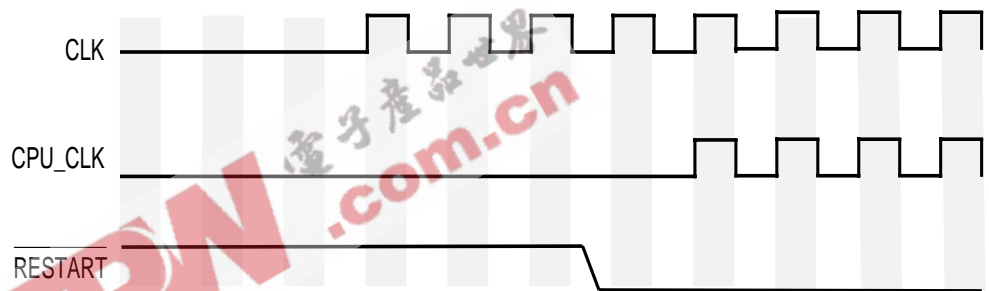

Figure 6. MC68SEC000 Clock Start Timing

4. If the MC68SEC000 was placed in a three-state condition, the $\overline{\text{BR}}$ signal must be negated before the processor can begin executing instructions.

An example trap routine is as follows:

```
TRAP_x  MOVE.B #0,$low_power_address /* Write that causes ADDRESS_MATCH to as
        STOP #$2000 /* STOP instruction with desired interrupt mask
        RTE /* Return from the exception */
```

The first instruction (MOVE.B #0,\$low_power_address) writes a byte to the low-power address that cause the external circuitry to begin the sequence that will stop the processor's clock. The second instruction (STOP #\$2000) loads the SR with the immediate data. This lets you set the interrupt that cause the processor to come out of the low-power mode. The final instruction (RTE) tells the processor to return from the exception and resume normal processing.

3.0 MC68SEC000 ELECTRICAL SPECIFICATIONS

Add to the following table to Section 10.1.

3.1 MC68SEC000 MAXIMUM RATINGS

RATING	SYMBOL	VALUE	UNITS
Supply Voltage	V_{CC}	-0.3 to 6.5	V
Input Voltage	V_{in}	-0.5 to 6.5	V
Maximum Operating Temperature Range	T_A	T_L to T_H 0 to 70	$^{\circ}C$
Commercial Extended "C" Grade		-40 to 85	
Storage Temperature	T_{stg}	-55 to 150	$^{\circ}C$

3.2 CMOS CONSIDERATIONS

The following change should be made to Section 10.4, CMOS Considerations.

“Although the MC68HC000 and MC68EC000 is implemented with input protection diodes, care should be exercised to ensure that the maximum input voltage specification is not exceeded.” should read “Although the MC68HC000, MC68EC000, and MC68SEC000 are implemented with input protection diodes, careful not to exceed the maximum input voltage specification.”

4.0 MC68SEC000 AC ELECTRICAL SPECIFICATIONS

Replace Figure 10-2 on page 10-6 with Figure 7.

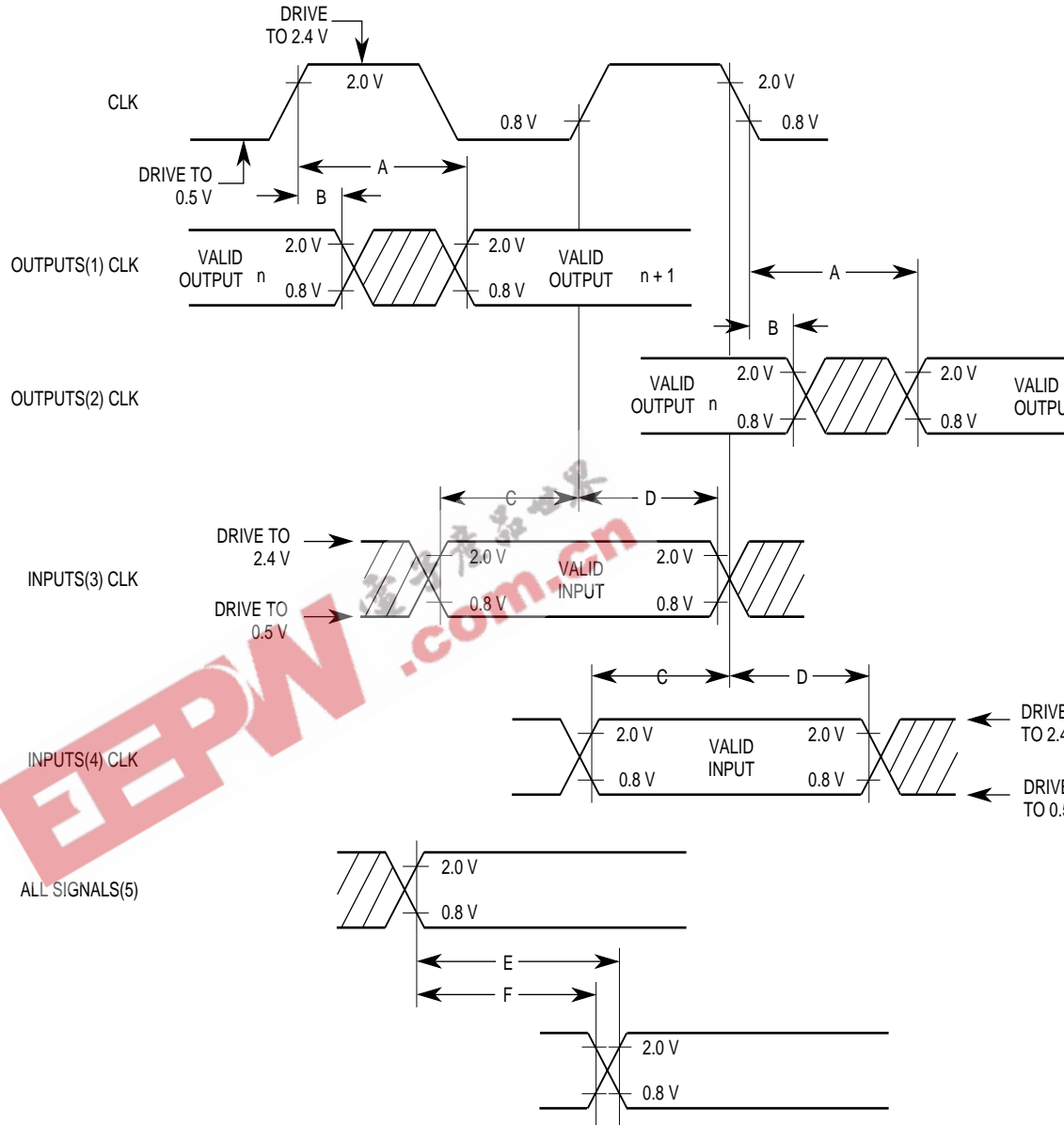

NOTES:

1. This output timing is applicable to all parameters specified relative to the rising edge of the clock.
2. This output timing is applicable to all parameters specified relative to the falling edge of the clock.
3. This input timing is applicable to all parameters specified relative to the rising edge of the clock.
4. This input timing is applicable to all parameters specified relative to the falling edge of the clock.
5. This timing is applicable to all parameters specified relative to the assertion/negation of another signal.

LEGEND:

- A. Maximum output delay specification.
- B. Minimum output hold time.
- C. Minimum input setup time specification.
- D. Minimum input hold time specification.
- E. Signal valid to signal valid specification (maximum or minimum).
- F. Signal valid to signal invalid specification (maximum or minimum).

Figure 7. Drive Levels and Test Points for AC Specifications - applies to all parts

5.0 MC68SEC000 DC ELECTRICAL SPECIFICATIONS

Add the following table to Section 10.13 on page 10-23.

($V_{CC} = 5.0 \text{ Vdc} \pm 5\%$, $3.3 \text{ Vdc} \pm 10\%$; $GND = 0 \text{ Vdc}$; $T_A = T_L \text{ to } T_H$)

CHARACTERISTIC	SYMBOL	3.3 V		5.0 V	
		MIN	MAX	MIN	MAX
Input High Voltage	V_{IH}	2.0	V_{CC}	2.0	V_{CC}
Input Low Voltage	V_{IL}	GND	0.8	$GND - 0.5$	0.8
Input Leakage Current \overline{BERR} , \overline{BR} , \overline{DTACK} , CLK, TPL2-IPL0, \overline{AVEC} MODE, HALT, RESET	I_{in}	—	2.5 20	—	2.5 20
Three-State (Off State) Input Current	I_{TSI}	—	2.5	—	2.5
Output High Voltage	V_{OH}	2.4	—	$V_{CC} - 0.75$	—
Output Low Voltage (IOL = 1.6 mA) HALT (IOL = 3.2 mA) A23-A0, \overline{BG} , FC2-FC0 (IOL = 5.0 mA) RESET (IOL = 5.3 mA) \overline{AS} , D15-D0, \overline{LDS} , $\overline{R\overline{W}}$, \overline{UDS}	V_{OL}	—	0.5 0.5 0.5 0.5	—	0.5 0.5 0.5 0.5
Current Dissipation* f = 0 Hz	I_D	—	0.7	—	1.0
f=10MHz		—	10	—	15
f=16 MHz		—	15	—	25
f= 20 MHz		—	20	—	30
Capacitance ($V_{in} = 0 \text{ V}$, $T_A = 25 \text{ }^\circ\text{C}$, Frequency = 1 MHz)**	C_{in}	—	20.0	—	20.0
Load Capacitance HALT All Others	CL	—	70 130	—	70 130

*During normal operation, instantaneous V_{CC} current requirements may be as high as 1.5A.

Currents listed are with no loading.

**Capacitance is periodically sampled rather than 100% tested.

6.0 MC68SEC000 AC ELECTRICAL SPECIFICATIONS — CLOCK TIMING (See Figure 2)

Add the following table and Figure 8 to Section 10.9 on page 10-9.

NUM.	CHARACTERISTIC	SYMBOL	10MHz		16MHz		20MHz	
			MIN	MAX	min	max	min	max
	Frequency of Operation	f	0	10.0	0	16.7	0	20.0
1	Cycle time	t _{cy}	100	—	60	—	50	—
2,3	Clock Pulse Width	t _{CL}	45	—	27	—	21	—
		t _{CH}	45	—	27	—	21	—
4,5	Clock Rise and Fall Times	t _{Cr}	—	10	—	5	—	4
		t _{Cf}	—	10	—	5	—	4

Applies to 3.3V and 5V.

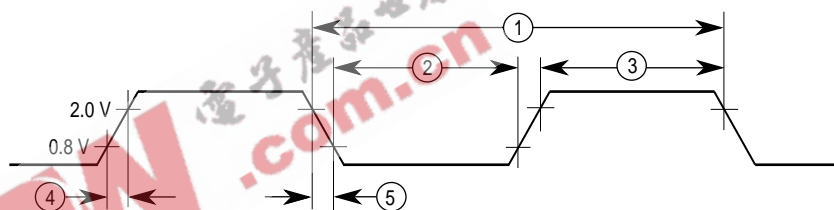

NOTE: Timing measurements are referenced to and from a low voltage of 0.8 V and a high voltage of 2.0 V, unless otherwise noted. The voltage swing through this range should start outside and pass through the range such that the rise or fall will be linear between 0.8 V and 2.0 V.

Figure 8. MC68SEC000 Clock Input Timing Diagram

7.0 MC68SEC000 AC ELECTRICAL SPECIFICATIONS — READ AND WRITE CYCLES

Add the following table and Figures 9 and 10 to Section 10.16.

Applies to 3.3V and 5V.

(GND = 0 V; $T_A = T_L$ to T_H ; see Figures 3 and 4)

NUM	CHARACTERISTIC	10MHz		16MHz		20MHz	
		MIN	MAX	MIN	MAX	MIN	MAX
6	Clock Low to Address Valid	—	35	—	30	—	25
6A	Clock High to FC Valid	0	35	0	30	0	25
7	Clock High to Address, Data Bus High Impedance (Maximum) (Write)	—	55	—	50	—	42
8	Clock High to Address, FC Invalid (Minimum)	0	—	0	—	0	—
9 ¹	Clock High to \overline{AS} , \overline{LDS} , \overline{UDS} Asserted	3	35	3	30	3	25
11 ²	Address Valid to \overline{AS} , \overline{LDS} , \overline{UDS} Asserted (Read)/ \overline{AS} Asserted (Write)	20	—	15	—	10	—
11A ²	FC Valid to \overline{AS} , \overline{LDS} , \overline{UDS} Asserted (Read)/ \overline{AS} Asserted (Write)	45	—	45	—	40	—
12 ¹	Clock Low to \overline{AS} , \overline{LDS} , \overline{UDS} Negated	3	35	3	30	3	25
13 ²	\overline{AS} , \overline{LDS} , \overline{UDS} Negated to Address, FC Invalid	15	—	15	—	10	—
14 ²	\overline{AS} (and \overline{LDS} , \overline{UDS} Read) Width Asserted	195	—	120	—	100	—
14A ²	\overline{LDS} , \overline{UDS} Width Asserted (Write)	95	—	60	—	50	—
15 ²	\overline{AS} , \overline{LDS} , \overline{UDS} Width Negated	105	—	60	—	50	—
16	Clock High to Control Bus High Impedance	—	55	—	50	—	42
17 ²	\overline{AS} , \overline{LDS} , \overline{UDS} Negated to $\overline{R/\overline{W}}$ Invalid	15	—	15	—	10	—
18 ¹	Clock High to $\overline{R/\overline{W}}$ High (Read)	0	35	0	30	0	25
20 ¹	Clock High to $\overline{R/\overline{W}}$ Low (Write)	0	35	0	30	0	25
20A ^{2,6}	\overline{AS} Asserted to $\overline{R/\overline{W}}$ Low (Write)	—	10	—	10	—	10
21 ²	Address Valid to $\overline{R/\overline{W}}$ Low (Write)	0	—	0	—	0	—
21A ²	FC Valid to $\overline{R/\overline{W}}$ Low (Write)	50	—	30	—	25	—
22 ²	$\overline{R/\overline{W}}$ Low to \overline{DS} Asserted (Write)	50	—	30	—	25	—
23	Clock Low to Data-Out Valid (Write)	—	35	—	30	—	25
25 ²	\overline{AS} , \overline{LDS} , \overline{UDS} Negated to Data-Out Invalid (Write)	30	—	15	—	10	—
26 ²	Data-Out Valid to \overline{LDS} , \overline{UDS} Asserted (Write)	30	—	15	—	10	—
27 ⁵	Data-In Valid to Clock Low (Setup Time on Read)	5	—	5	—	5	—
28 ²	\overline{AS} , \overline{LDS} , \overline{UDS} Negated to \overline{DTACK} Negated (Asynchronous Hold)	0	110	0	110	0	95
28A	Clock High to \overline{DTACK} Negated	0	110	0	110	0	95

AC ELECTRICAL SPECIFICATIONS — READ AND WRITE CYCLES (Continued)

NUM	CHARACTERISTIC	10MHz		16MHz		20MHz	
		MIN	MAX	MIN	MAX	MIN	MAX
29	\overline{AS} , \overline{LDS} , \overline{UDS} Negated to Data-In Invalid (Hold Time on Read)	0	—	0	—	0	—
29A	\overline{AS} , \overline{LDS} , \overline{UDS} Negated to Data-In High Impedance (Read)	—	150	—	90	—	75
30	\overline{AS} , \overline{LDS} , \overline{UDS} Negated to \overline{BERR} Negated	0	—	0	—	0	—
31 ^{2,5}	\overline{DTACK} Asserted to Data-In Valid (Setup Time on Read)	—	65	—	50	—	42
32	\overline{HALT} and \overline{RESET} Input Transition Time	0	150	0	150	0	150
33	Clock High to \overline{BG} Asserted	—	35	—	30	—	25
34	Clock High to \overline{BG} Negated	—	35	—	30	—	25
35	\overline{BR} Asserted to \overline{BG} Asserted	1.5	3.5	1.5	3.5	1.5	3.5
36 ⁷	\overline{BR} Negated to \overline{BG} Negated	1.5	3.5	1.5	3.5	1.5	3.5
38	\overline{BG} Asserted to Control, Address, Data Bus High Impedance (\overline{AS} Negated)	—	55	—	50	—	42
39	\overline{BG} Width Negated	1.5	—	1.5	—	1.5	—
44	\overline{AS} , \overline{LDS} , \overline{UDS} Negated to \overline{AVEC} Negated	0	55	0	50	0	42
47 ⁵	Asynchronous Input Setup Time	5	—	5	—	5	—
48 ^{2,3}	\overline{BERR} Asserted to \overline{DTACK} Asserted	20	—	10	—	10	—
52	Data-In Hold from Clock High	0	—	0	—	0	—
53	Data-Out Hold from Clock High (Write)	0	—	0	—	0	—
55	R/W Asserted to Data Bus Impedance Change (Write)	20	—	10	—	0	—
56 ⁴	\overline{HALT} , \overline{RESET} Pulse Width	10	—	10	—	10	—
58 ⁷	\overline{BR} Negated to \overline{AS} , \overline{LDS} , \overline{UDS} , R/W Driven	1.5	—	1.5	—	1.5	—
58A ⁷	\overline{BR} Negated to FC Driven	1	—	1	—	1	—

Applies to 3.3V and 5V.

- NOTES:
- For a loading capacitance of less than or equal to 50 pF, subtract 5 ns from the value given in the maximum column.
 - Actual value depends on clock period.
 - If #47 is satisfied for both \overline{DTACK} and \overline{BERR} , #48 may be ignored. In the absence of \overline{DTACK} , \overline{BERR} is an asynchronous input and its setup time is determined by using the asynchronous input setup time (#47).
 - For power-up, the MC68SEC000 must be held in the reset state for 100 ms to allow stabilization of on-chip circuitry. After the system is powered up, #56 refers to the minimum pulse width required to reset the controller.
 - If the asynchronous input setup time (#47) requirement is satisfied for \overline{DTACK} , the \overline{DTACK} asserted to data setup time requirement can be ignored. The data must only satisfy the data-in to clock low setup time (#27) for the following clock cycle.
 - When \overline{AS} and $\overline{R/W}$ are equally loaded ($\pm 20\%$), subtract 5 ns from the values given in these columns.
 - The minimum value must be met to guarantee proper operation. If the maximum value is exceeded, \overline{BG} may be reasserted.

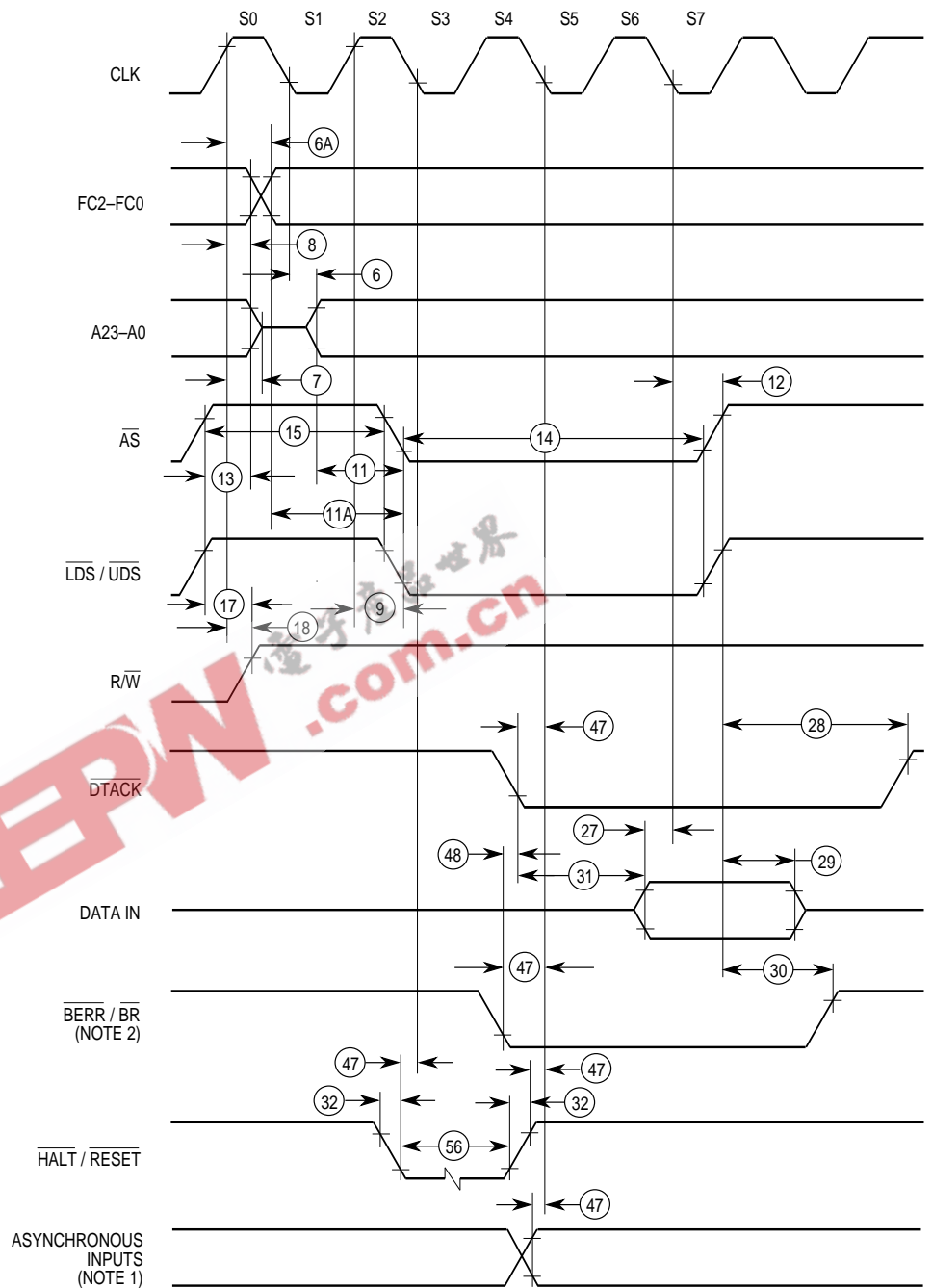

NOTES:

1. Setup time for the asynchronous inputs $\overline{IPL2}$ – $\overline{IPL0}$ and \overline{AVEC} (#47) guarantees their recognition at the next falling edge of the clock.
2. BR need fall at this time only to insure being recognized at the end of the bus cycle.
3. Timing measurements are referenced to and from a low voltage of 0.8 V and a high voltage of 2.0 V, unless otherwise noted. The voltage swing through this range should start outside and pass through the range such that the rise or fall is linear between 0.8 V and 2.0 V.

Figure 9. MC68SEC000 Read Cycle Timing Diagram

8.0 MC68SEC000 AC ELECTRICAL SPECIFICATIONS — BUS ARBITRATION

Add the following table and Figure 11 to Section 10.17.

(GND = 0 Vdc; $T_A = T_L$ to T_H ; refer to Figure 13)

NUM	CHARACTERISTIC _p	10MHz		16MHz		20MHz	
		MIN	MAX	MIN	MAX	MIN	MAX
7	Clock High to Address, Data Bus High Impedance (Maximum)	—	55	—	50	—	42
16	Clock High to Control Bus High Impedance	—	55	—	50	—	42
33	Clock High to \overline{BG} Asserted	0	35	0	30	0	25
34	Clock High to \overline{BG} Negated	0	35	0	30	0	25
35	\overline{BR} Asserted to \overline{BG} Asserted	1.5	3.5	1.5	3.5	1.5	3.5
36	\overline{BR} Negated to \overline{BG} Negated	1.5	3.5	1.5	3.5	1.5	3.5
38	\overline{BG} Asserted to Control, Address, Data Bus High Impedance (\overline{AS} Negated)	—	55	—	50	—	42
39	\overline{BG} Width Negated	1.5	—	1.5	—	1.5	—
47	Asynchronous Input Setup Time	5	—	5	—	5	—
58 ¹	\overline{BR} Negated to \overline{AS} , \overline{LDS} , \overline{UDS} , R/W Driven	1.5	—	1.5	—	1.5	—
58A ¹	\overline{BR} Negated to \overline{FC} Driven	1	—	1	—	1	—

Applies to 3.3V and 5V.

1. The minimum value must be met to guarantee proper operation. If the maximum value is exceeded, \overline{BG} may be reasserted.

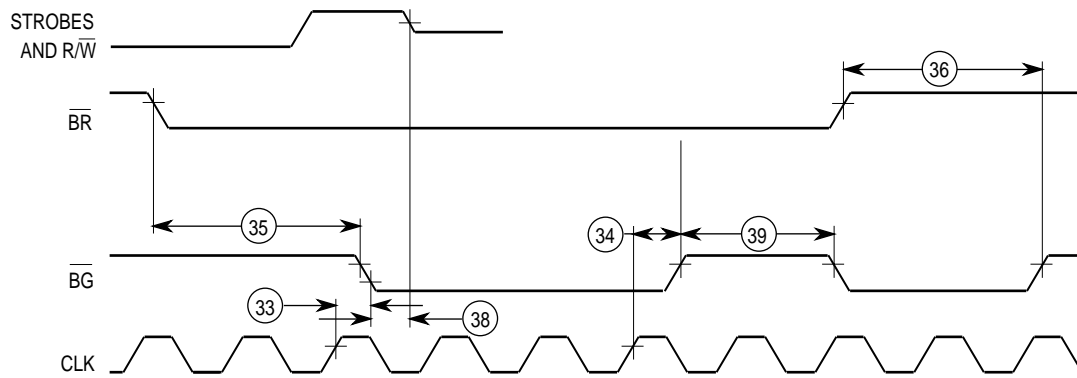

NOTE: Setup time to the clock (#47) for the asynchronous inputs $\overline{\text{BERR}}$, $\overline{\text{BR}}$, $\overline{\text{DTACK}}$, $\overline{\text{IPL2-IPL0}}$, and $\overline{\text{VPA}}$ guarantees their recognition at the next falling edge of the clock.

Figure 11. Bus Arbitration Timing

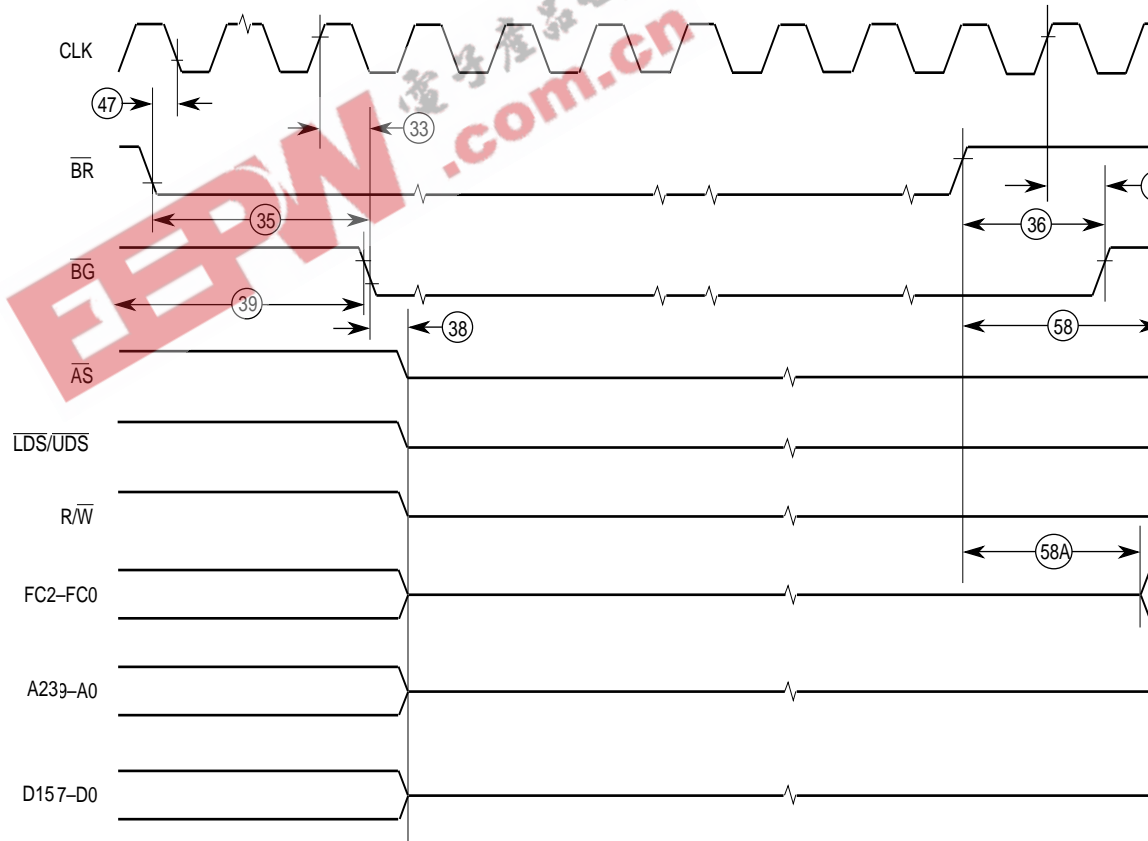

NOTE: Waveform measurements for all inputs and outputs are specified at: logic high 2.0 V, logic low = 0.8 V.

Figure 12. MC68SEC000 Bus Arbitration Timing Diagram

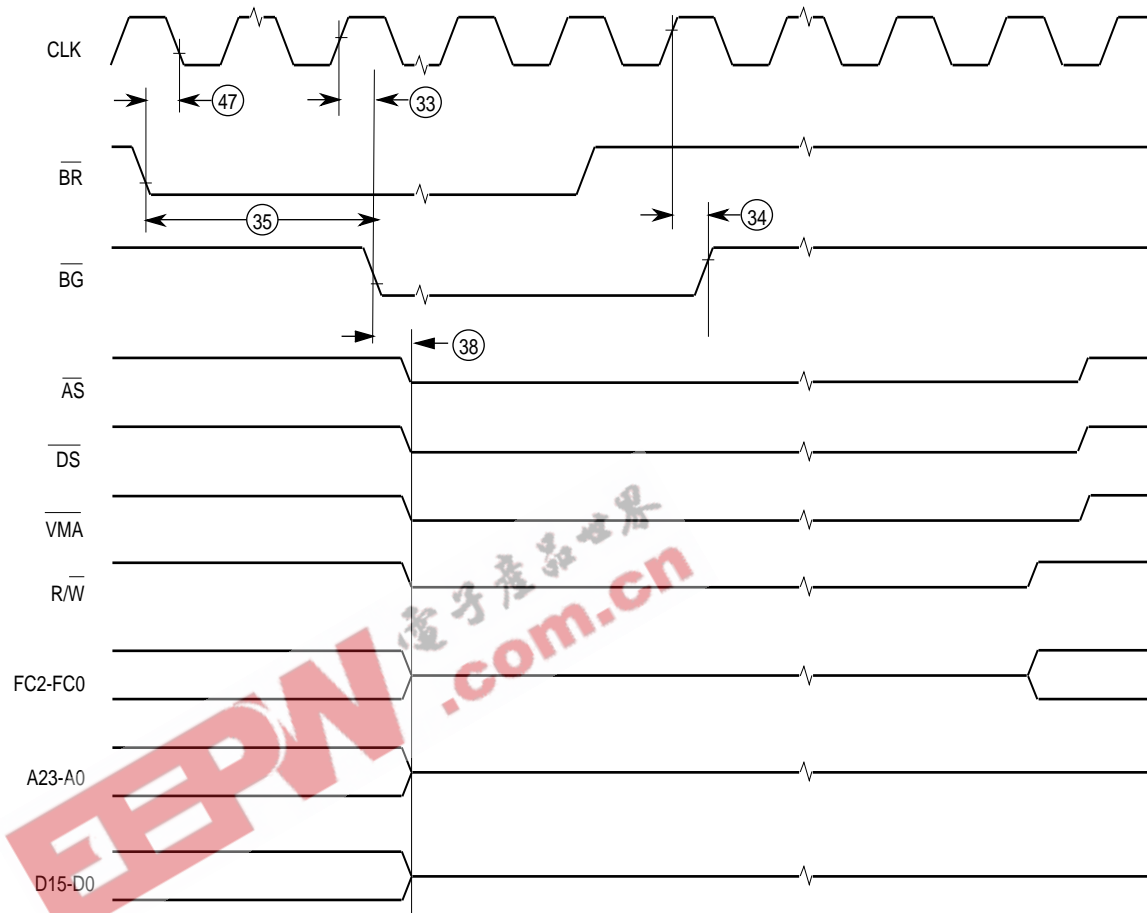

NOTES: Waveform measurements for all inputs and outputs are specified at: logic high = 2.0 V, logic low = 0.8 V. This diagram also applies to the 6

Figure 13. Bus Arbitration Timing—Idle Bus Case

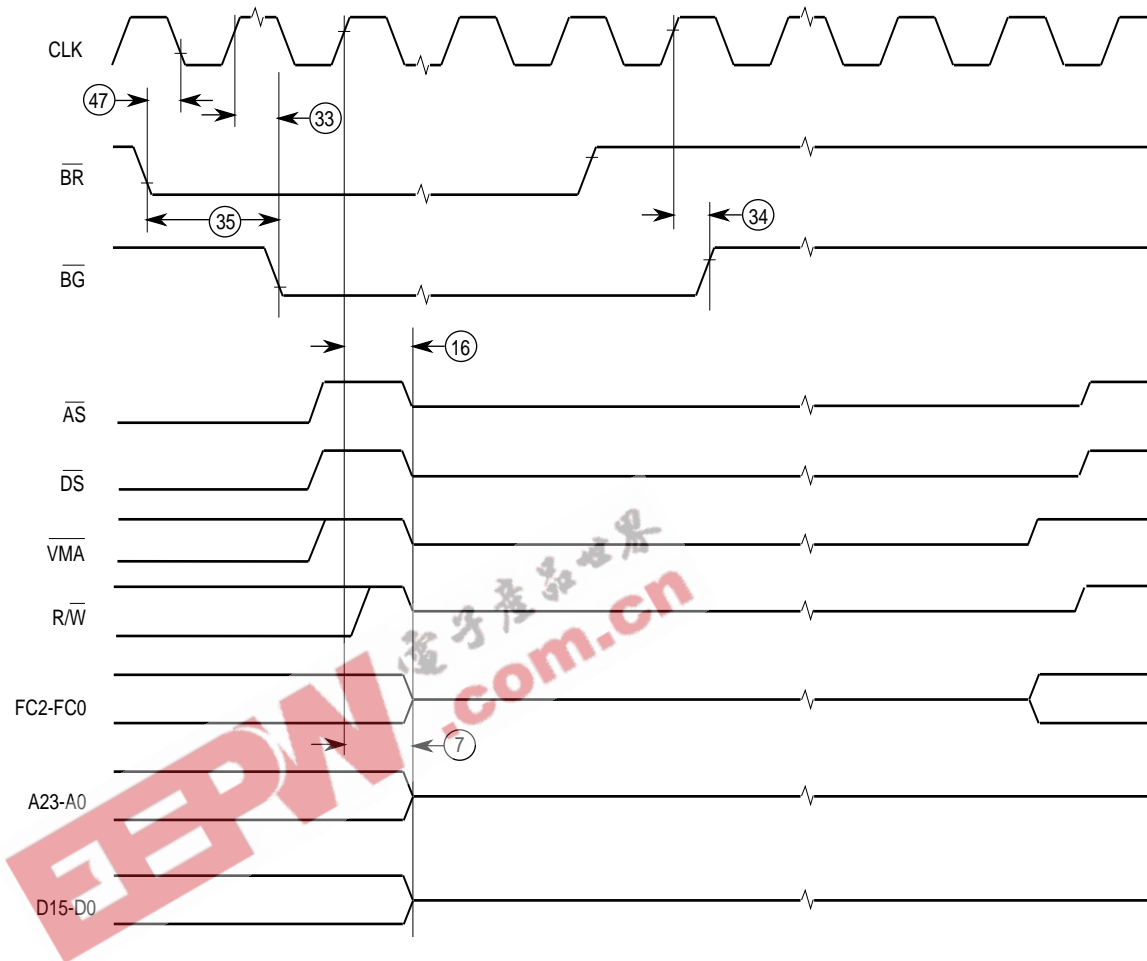

NOTE: Waveform measurements for all inputs and outputs are specified at: logic high 2.0 V, logic low = 0.8 V.
This diagram also applies to the 68EC000.

Figure 14. Bus Arbitration Timing - Active Bus Case

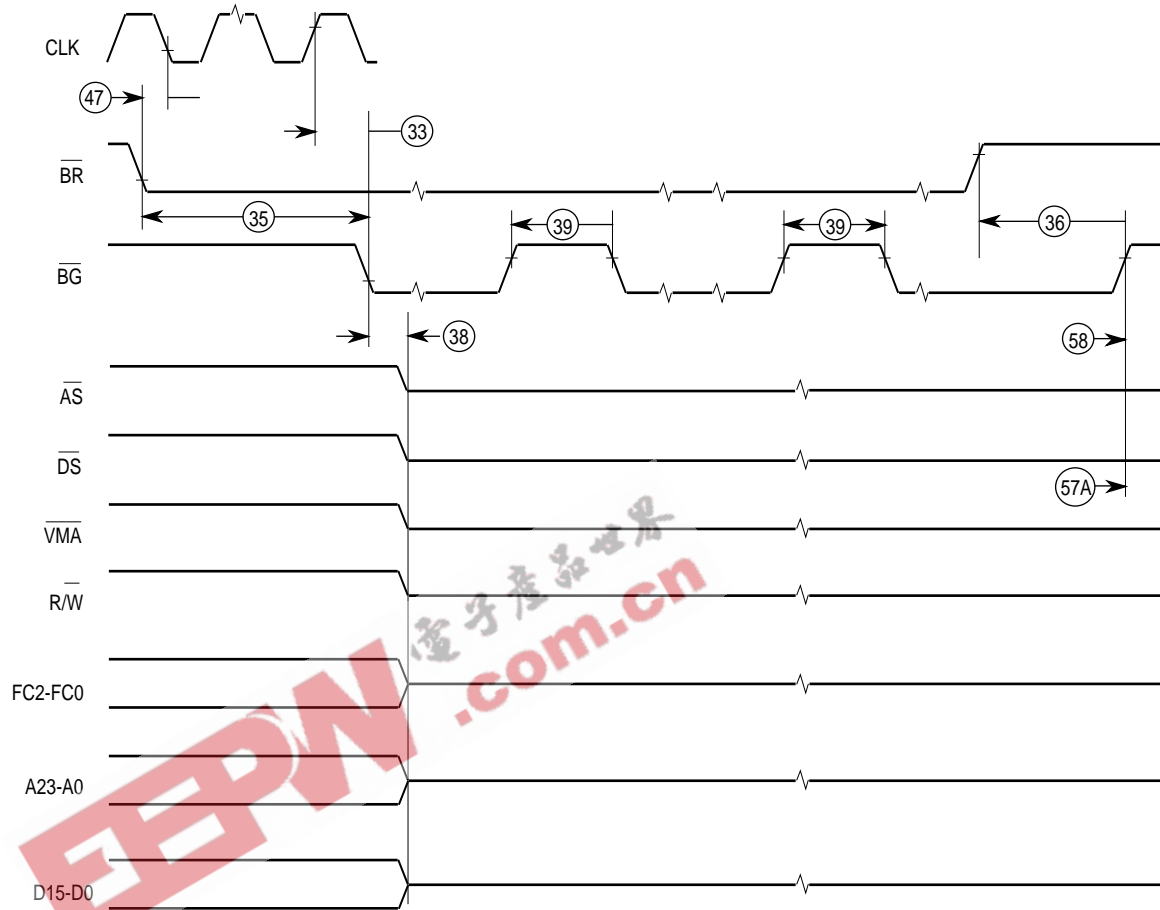

NOTES: Waveform measurements for all inputs and outputs are specified at: logic high 2.0 V, logic low = 0.8 V.
This diagram also applies to the 68EC000.

Figure 15. Bus Arbitration - Multiple Bus Request

9.0 MECHANICAL DATA

9.1 PIN ASSIGNMENTS

Add Figure 12 to Section 11.1.

The following defines the pin assignment and the package dimensions of the 64 lead QFP (FU package) and 64 lead TQFP (PB package) for the MC68SEC000. Note that it is pin-to-pin compatible with the MC68EC000.

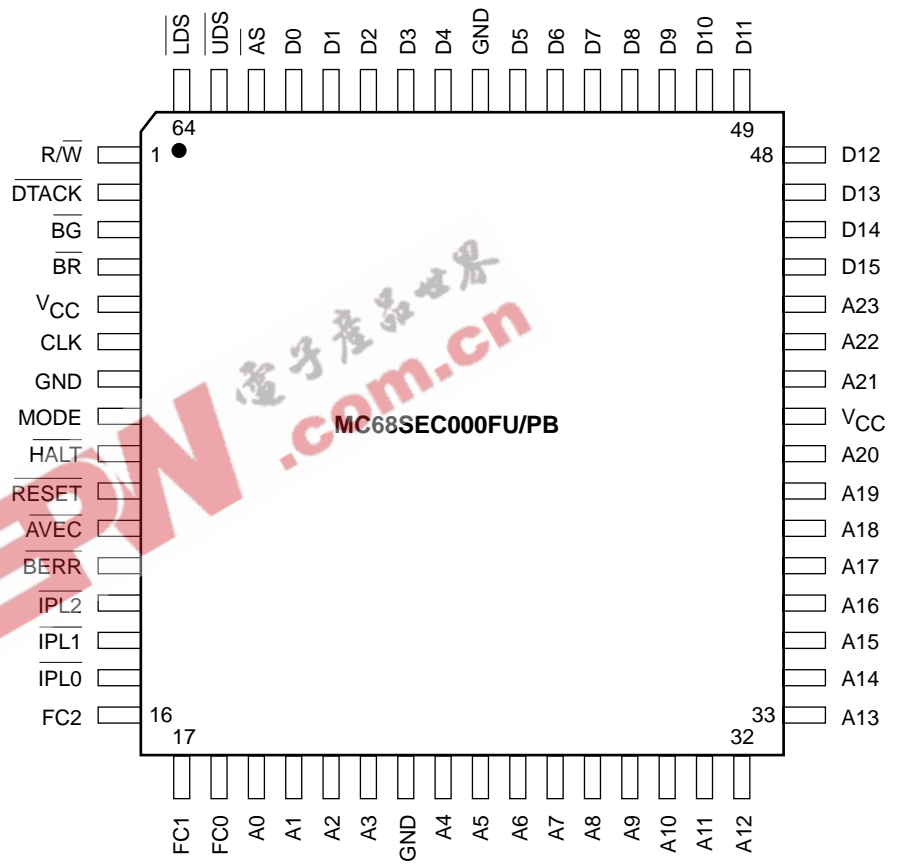
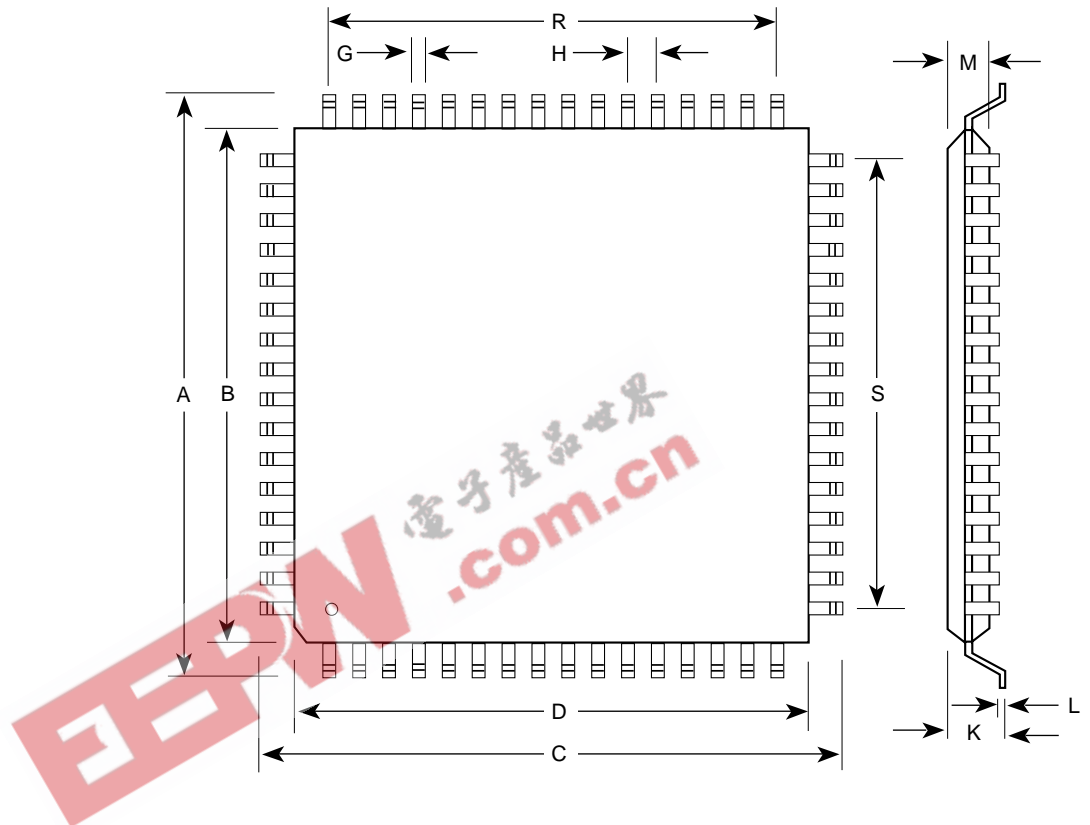

Figure 16. 64-Lead Quad Flat Pack and 64-Lead Thin Quad Flat Pack

10.0 PACKAGE DIMENSIONS - FU SUFFIX

This diagram replaces the one on Page 11-16

64 Lead Quad Flat Pack Case 840B-01



DIM	MILLIMETERS		INCHES	
	MIN	MAX	MIN	MAX
A	16.95	17.45	0.667	0.687
B	13.90	14.10	0.547	0.555
C	16.95	17.45	0.667	0.687
D	13.90	14.10	0.547	0.555
G	0.30	0.45	0.012	0.018
H	0.80 BSC		0.031 BSC	
K	2.15	2.45	0.085	0.096
L	0.13	0.23	0.005	0.009
M	2.00	2.40	0.79	0.094
R	12.00 REF		0.472 REF	
S	12.00 REF		0.472 REF	

11.0 PACKAGE DIMENSIONS - PB SUFFIX

Add the following to Section 11.2.

64 Lead Thin Quad Flat Pack Case 840F-02

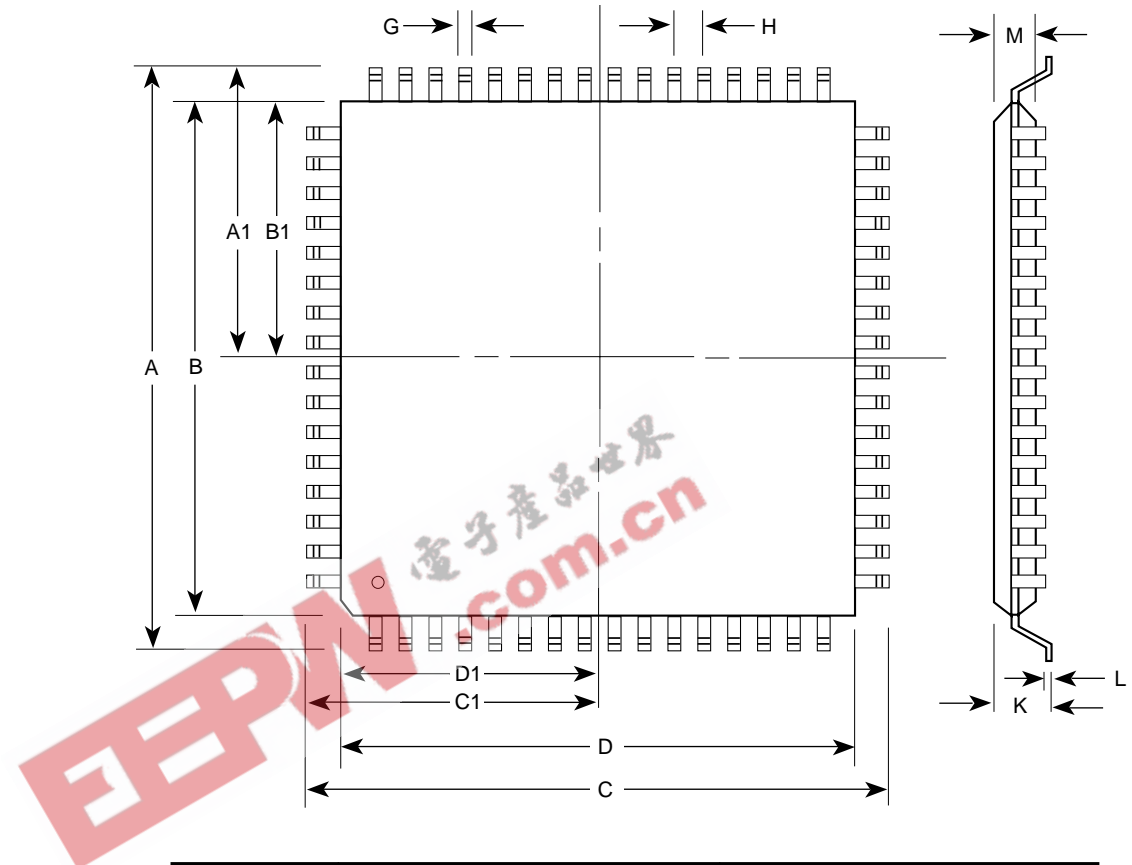

DIM	MILLIMETERS		INCHES	
	MIN	MAX	MIN	MAX
A	12.00 BSC		0.472 BSC	
A1	6.00 BSC		0.236 BSC	
B	10.00 BSC		0.394 BSC	
B1	5.00 BSC		0.197 BSC	
C	12.00 BSC		0.472 BSC	
C1	6.00 BSC		0.236 BSC	
D	10.00 BSC		0.394 BSC	
D1	5.00 BSC		0.197 BSC	
G	0.17	0.27	0.007	0.011
H	0.50 BSC		0.020 BSC	
K	---	1.60	---	0.063
L	0.09	0.20	0.004	0.008
M	1.35	1.45	0.053	0.057

12.0 PACKAGE/FREQUENCY AVAILABILITY

Replaces Section 11.1

The following tables identify the packages and operating frequencies available for the MC68HC000, MC68HC001, MC68EC000, and the MC68SEC000.

MC68SEC000 PACKAGE	FREQUENCY	VOLTAGE	
		3.3 V	5 V
Quad Flat Pack (FU)	10 MHz	✓	✓
	16 MHz	✓	✓
	20MHz	✓	✓
Thin Quad Flat Pack (PB)	10 MHz	✓	✓
	16 MHz	✓	✓
	20MHz	✓	✓

MC68HC000 PACKAGE	FREQUENCY	VOLTAGE 5V
Plastic DIP	8,10,12,16,20 MHz	3
Plastic Quad Pack (PLCC)	8,10,12,16,20 MHz	3
Plastic Quad (Gull Wing)**	8,10,12,16,20 MHz	3
Pin Grid Array, Solder Lead Finish**	8,10,12,16,20 MHz	3
Pin Grid Array, Gold Lead Finish**	8,10,12,16,20 MHz	3
Plastic Quad Pack (PLCC)	8,10,12,16,20 MHz	3

MC68HC001** PACKAGE	FREQUENCY	VOLTAGE 5V
Plastic Quad Pack (PLCC)	8,10,12,16 MHz	✓
Plastic Quad (Gull Wing)	8,10,12,16 MHz	✓
Pin Grid Array, Gold Lead Finish	8,10,12,16 MHz	✓
	8,10,12,16 MHz	✓

MC68EC000 PACKAGE	FREQUENCY	VOLTAGE 5V
Plastic Quad Pack (PLCC)	8 MHz	✓
Plastic Quad Flat Pack	10 MHz	✓
	12 MHz	✓
	16 MHz	✓
	20 MHz	✓

NOTE : ** not recommended for new designs

ORDERING INFORMATION

Add the following to Section 11.

The following tables contains the ordering information for the MC68SEC000.

MC68SEC000 Ordering Information

PACKAGE	BODY SIZE	LEAD SPACING	SPEED (IN MH Z)	VOLTAGE	SUFFIX	TEMPER RAN
QFP	14.0 mm X 14.0mm	0.8mm	10/16/20 MHz	3.3V or 5.0V	FU	0C to +
					CFU	-40C to
TQFP	10.0mm x 10.0mm	0.5mm			PB	0C to +
					CPB	-40C to

MC68HC000 Ordering Information

PACKAGE	BODY SIZE	LEAD SPACING	SPEED (INMHZ)	VOLTAGE	SUFFIX	TEMPER RAN
DIP	81.91mm X 20.57mm	2.54mm	8, 10, 12, 16	5.0V	P	0C to
PLCC	25.57mm X 25.27mm	1.27mm	8, 10, 12, 16, 20		FN	0C to
			8, 10, 12, 16		CFN	-40C to

MC68EC000 Ordering Information

PACKAGE	BODY SIZE	LEAD SPACING	SPEED (INMHZ)	VOLTAGE	SUFFIX	TEMPER RAN
PLCC	25.57mm X 25.27mm	1.27mm	8, 10,12, 16, 20	5.0V	FN	0C to
PQFP	14.1mm X 14.1mm	0.8mm	8, 10,12, 16, 20		FU	

DOCUMENTATION

Add to Section 11.

The documents listed in the following table contain detailed information that pertain to the MC68SEC000 processor. You can obtain these documents from the Literature Distribution Centers listed on the last page of this document.

MC68SEC000 Documentation

MC68SEC000 DOCUMENTATION	DOCUMENT NUMBER
M68000 Family Programmer's Reference Manual	M68000PM/AD
M68000 User's Manual	M68000UM/AD
High Performance Embedded Systems Source Catalog"	BR729/D
MC68EC000 Product Brief	MC68EC000/D
MC68SEC000 Product Brief	MC68SEC000/D

EEPW 电子產品世界
.com.cn

Motorola reserves the right to make changes without further notice to any products herein. Motorola makes no warranty, representation or guarantee of the suitability of its products for any particular purpose, nor does Motorola assume any liability arising out of the application or use of any product specifically disclaims any and all liability, including without limitation consequential or incidental damages. "Typical" parameters can and do vary in actual applications. All operating parameters, including "Typicals" must be validated for each customer application by customer's technical experts. Motorola does not convey any license under its patent rights nor the rights of others. Motorola products are not designed, intended, or authorized for use as components in systems intended for surgical implant into the body, or other applications intended to support or sustain life, or for any other application in which the failure of a Motorola product could create a situation where personal injury or death may occur. Should Buyer purchase or use Motorola products for any such application, Buyer shall indemnify and hold Motorola and its officers, employees, subsidiaries, affiliates, and distributors harmless against all claims, costs, damages, and expenses, and reasonable attorney fees arising out of, directly or indirectly, any claim of personal injury or death or any such unintended or unauthorized use, even if such claim alleges that Motorola was negligent regarding the design or manufacture of the part. Motorola and the M logo are registered trademarks of Motorola, Inc. Motorola, Inc. is an Equal Opportunity/Affirmative Action Employer.

Literature Distribution Centers:

USA/EUROPE: Motorola Literature Distribution; P.O. Box 20912, Arizona 85036.

JAPAN: Nippon Motorola Ltd.; 4-32-1, Nishi-Gotanda, Shinagawa-ku, Tokyo 141 Japan.

ASIA-PACIFIC: Motorola Semiconductors H.K. Ltd.; Silicon Harbour Center, No. 2 Dai King Street, Tai Po Industrial Estate, Tai Po, N.T., Hong Kong.