

Silicon Controlled Rectifiers Reverse Blocking Triode Thyristors

... PNP devices designed for high volume, low cost consumer applications such as temperature, light and speed control; process and remote control; and warning systems where reliability of operation is critical.

- Small Size
- Passivated Die Surface for Reliability and Uniformity
- Low Level Triggering and Holding Characteristics
- Recommend Electrical Replacement for C106
- Available in Two Package Styles:
 - Surface Mount Leadforms — Case 369A
 - Miniature Plastic Package — Straight Leads — Case 369

ORDERING INFORMATION

- To Obtain "DPAK" in Surface Mount Leadform (Case 369A):
 - Shipped in Sleeves — No Suffix, i.e., MCR706A
 - Shipped in 16 mm Tape and Reel — Add "RL" Suffix to Device Number, i.e., MCR706ARL
- To Obtain "DPAK" in Straight Lead Version:
 - Shipped in Sleeves — Add '1' Suffix to Device Number, i.e., MCR706A1

MAXIMUM RATINGS (T_J = 25°C unless otherwise noted.)

Characteristic	Symbol	Value	Unit
Peak Repetitive Forward and Reverse Blocking Voltage (1) (1/2 Sine Wave) (R _{GK} = 1000 Ohms, T _C = -40 to +110°C)	V _{DRM} or V _{RRM}	MCR703A1, MCR703A MCR704A1, MCR704A MCR706A1, MCR706A MCR708A1, MCR708A	Volts
Peak Non-repetitive Reverse Blocking Voltage (1/2 Sine Wave, R _{GK} = 1000 Ohms, T _C = -40 to +110°C)	V _{RSM}	MCR703A1, MCR703A MCR704A1, MCR704A MCR706A1, MCR706A MCR708A1, MCR708A	Volts
Average On-State Current (T _C = -40 to +90°C) (T _C = +100°C)	I _{T(AV)}	2.6 1.6	Amps
Surge On-State Current (1/2 Sine Wave, 60 Hz, T _C = +90°C) (1/2 Sine Wave, 1.5 ms T _C = +90°C)	I _{TSM}	25 35	Amps
Circuit Fusing (t = 8.3 ms)	I ² t	2.6	A ² s
Peak Gate Power (Pulse Width = 10 μs, T _C = 90°C)	P _{GM}	0.5	Watt
Average Gate Power (t = 8.3 ms, T _C = 90°C)	P _{G(AV)}	0.1	Watt
Peak Forward Gate Current	I _{GM}	0.2	Amp
Peak Reverse Gate Voltage	V _{RGM}	6	Volts
Operating Junction Temperature Range	T _J	-40 to +110	°C
Storage Temperature Range	T _{stg}	-40 to +150	°C

1. V_{DRM} and V_{RRM} for all types can be applied on a continuous basis. Ratings apply for zero or negative gate voltage; however, positive gate voltage shall not be applied concurrent with negative potential on the anode. Blocking voltages shall not be tested with a constant current source such that the voltage ratings of the devices are exceeded.

Preferred devices are Motorola recommended choices for future use and best overall value.

REV 1

MCR703A thru MCR708A*

*Motorola preferred devices

SCRs
4.0 AMPERES RMS
100 thru 600 VOLTS

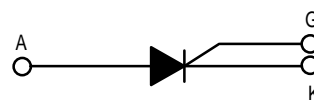

CASE 369A
STYLE 5

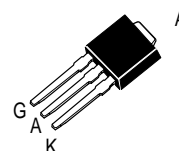

CASE 369
STYLE 5

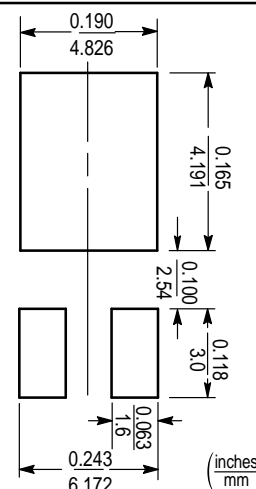

Figure 1. Minimum Pad
Sizes for
Surface Mounting

MCR703A thru MCR708A

THERMAL CHARACTERISTICS

Characteristic	Symbol	Min	Max	Unit
Thermal Resistance, Junction to Case	$R_{\theta JC}$	—	8.33	$^{\circ}\text{C}/\text{W}$
Thermal Resistance, Junction to Ambient (Case 369A-04) ⁽¹⁾	$R_{\theta JA}$	—	80	$^{\circ}\text{C}/\text{W}$
Thermal Resistance, Junction to Ambient (Case 369-03) ⁽²⁾	$R_{\theta JA}$	—	85	$^{\circ}\text{C}/\text{W}$

ELECTRICAL CHARACTERISTICS ($T_C = 25^{\circ}\text{C}$ and $R_{GK} = 1000$ ohms unless otherwise noted.)

Characteristic	Symbol	Min	Typ	Max	Unit
Peak Forward or Reverse Blocking Current ($V_{AK} = \text{Rated } V_{DRM} \text{ or } V_{RRM}$) $T_C = 25^{\circ}\text{C}$ $T_C = 110^{\circ}\text{C}$	I_{DRM}, I_{RRM}	— —	—	10 200	μA
Peak Forward "On" Voltage ($I_{TM} = 8.2$ A Peak, Pulse Width = 1 to 2 ms, 2% Duty Cycle)	V_{TM}	—	—	2.2	Volts
Gate Trigger Current (Continuous dc) ⁽³⁾ ($V_{AK} = 12$ Vdc, $R_L = 24$ Ohms) ($V_{AK} = 12$ Vdc, $R_L = 24$ Ohms, $T_C = -40^{\circ}\text{C}$)	I_{GT}	— —	25	75 300	μA
Gate Trigger Voltage (Continuous dc) (Source Voltage = 12 V, $R_S = 50$ Ohms) ($V_{AK} = 12$ Vdc, $R_L = 24$ Ohms, $T_C = -40^{\circ}\text{C}$)	V_{GT}	—	—	1	Volts
Gate Non-Trigger Voltage ($V_{AK} = \text{Rated } V_{DRM}$, $R_L = 100$ Ohms, $T_C = 110^{\circ}\text{C}$)	V_{GD}	0.2	—	—	Volts
Holding Current ($V_{AK} = 12$ Vdc, $I_{GT} = 2$ mA) $T_C = 25^{\circ}\text{C}$ (Initiating On-State Current = 200 mA) $T_C = -40^{\circ}\text{C}$	I_H	— —	—	5 10	mA
Total Turn-On Time (Source Voltage = 12 V, $R_S = 6$ k Ohms) ($I_{TM} = 8.2$ A, $I_{GT} = 2$ mA, Rated V_{DRM}) (Rise Time = 20 ns, Pulse Width = 10 μs)	t_{gt}	—	2	—	μs
Forward Voltage Application Rate ($V_D = \text{Rated } V_{DRM}$, Exponential Waveform, $T_C = 110^{\circ}\text{C}$)	dv/dt	—	10	—	$\text{V}/\mu\text{s}$

- Case 369A-04 when surface mounted on minimum pad sizes recommended.
- Case 369-03 standing in free air.
- R_{GK} current not included in measurement.

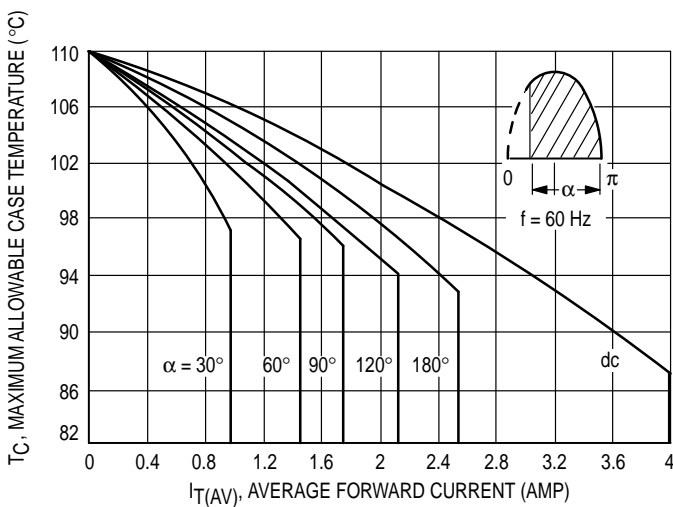

Figure 2. Maximum Case Temperature

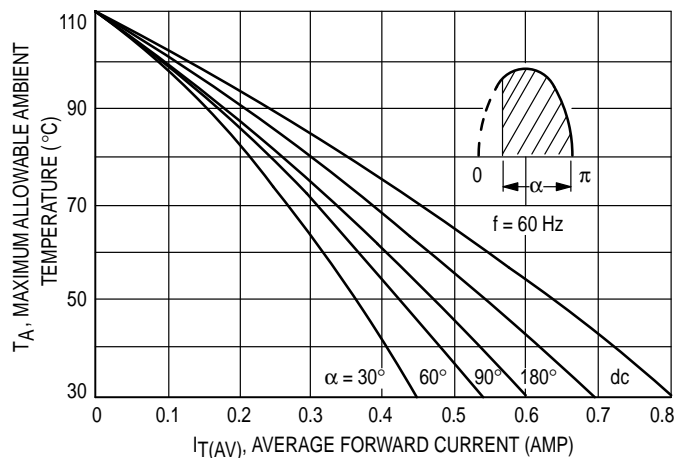
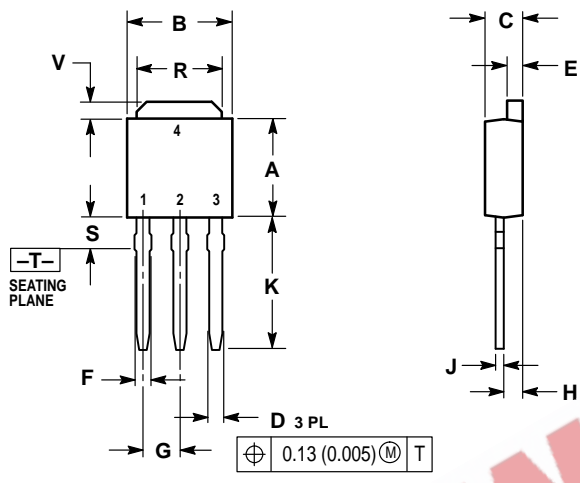

Figure 3. Maximum Ambient Temperature

PACKAGE DIMENSIONS



STYLE 5:
 PIN 1. GATE
 2. ANODE
 3. CATHODE
 4. ANODE

- NOTES:
 1. DIMENSIONING AND TOLERANCING PER ANSI Y14.5M, 1982.
 2. CONTROLLING DIMENSION: INCH.

DIM	INCHES		MILLIMETERS	
	MIN	MAX	MIN	MAX
A	0.235	0.250	5.97	6.35
B	0.250	0.265	6.35	6.73
C	0.086	0.094	2.19	2.38
D	0.027	0.035	0.69	0.88
E	0.033	0.040	0.84	1.01
F	0.037	0.047	0.94	1.19
G	0.090 BSC		2.29 BSC	
H	0.034	0.040	0.87	1.01
J	0.018	0.023	0.46	0.58
K	0.350	0.380	8.89	9.65
R	0.175	0.215	4.45	5.46
S	0.050	0.090	1.27	2.28
V	0.030	0.050	0.77	1.27

EEPW.com.cn 电子产品世界

CASE 369

MCR703A thru MCR708A

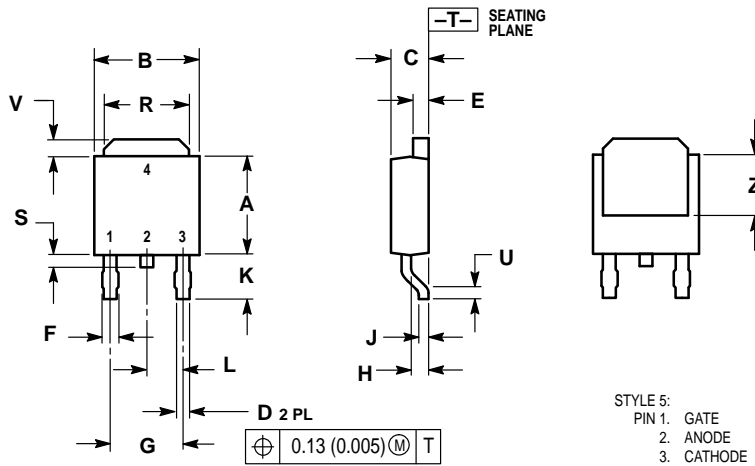

- NOTES:
1. DIMENSIONING AND TOLERANCING PER ANSI Y14.5M, 1982.
 2. CONTROLLING DIMENSION: INCH.

DIM	INCHES		MILLIMETERS	
	MIN	MAX	MIN	MAX
A	0.235	0.250	5.97	6.35
B	0.250	0.265	6.35	6.73
C	0.086	0.094	2.19	2.38
D	0.027	0.035	0.69	0.88
E	0.033	0.040	0.84	1.01
F	0.037	0.047	0.94	1.19
G	0.180 BSC		4.58 BSC	
H	0.034	0.040	0.87	1.01
J	0.018	0.023	0.46	0.58
K	0.102	0.114	2.60	2.89
L	0.090 BSC		2.29 BSC	
R	0.175	0.215	4.45	5.46
S	0.020	0.050	0.51	1.27
U	0.020	—	0.51	—
V	0.030	0.050	0.77	1.27
Z	0.138	—	3.51	—

- STYLE 5:
 PIN 1. GATE
 2. ANODE
 3. CATHODE
 4. ANODE

CASE 369A

Motorola reserves the right to make changes without further notice to any products herein. Motorola makes no warranty, representation or guarantee regarding the suitability of its products for any particular purpose, nor does Motorola assume any liability arising out of the application or use of any product or circuit, and specifically disclaims any and all liability, including without limitation consequential or incidental damages. "Typical" parameters can and do vary in different applications. All operating parameters, including "Typicals" must be validated for each customer application by customer's technical experts. Motorola does not convey any license under its patent rights nor the rights of others. Motorola products are not designed, intended, or authorized for use as components in systems intended for surgical implant into the body, or other applications intended to support or sustain life, or for any other application in which the failure of the Motorola product could create a situation where personal injury or death may occur. Should Buyer purchase or use Motorola products for any such unintended or unauthorized application, Buyer shall indemnify and hold Motorola and its officers, employees, subsidiaries, affiliates, and distributors harmless against all claims, costs, damages, and expenses, and reasonable attorney fees arising out of, directly or indirectly, any claim of personal injury or death associated with such unintended or unauthorized use, even if such claim alleges that Motorola was negligent regarding the design or manufacture of the part. Motorola and are registered trademarks of Motorola, Inc. Motorola, Inc. is an Equal Opportunity/Affirmative Action Employer.

Literature Distribution Centers:

USA: Motorola Literature Distribution; P.O. Box 20912; Phoenix, Arizona 85036.

EUROPE: Motorola Ltd.; European Literature Centre; 88 Tanners Drive, Blakelands, Milton Keynes, MK14 5BP, England.

JAPAN: Nippon Motorola Ltd.; 4-32-1, Nishi-Gotanda, Shinagawa-ku, Tokyo 141, Japan.

ASIA PACIFIC: Motorola Semiconductors H.K. Ltd.; Silicon Harbour Center, No. 2 Dai King Street, Tai Po Industrial Estate, Tai Po, N.T., Hong Kong.



MCR703A/D

