



MJE340
MJE350

COMPLEMENTARY SILICON POWER TRANSISTORS

- STMicroelectronics PREFERRED SALESTYPES
- COMPLEMENTARY PNP - NPN DEVICES

APPLICATIONS

- LINEAR AND SWITCHING INDUSTRIAL EQUIPMENT

DESCRIPTION

The MJE340 is a Silicon Epitaxial Planar NPN transistor intended for use in medium power linear and switching applications. It is mounted in SOT-32.

The complementary PNP type is MJE350.

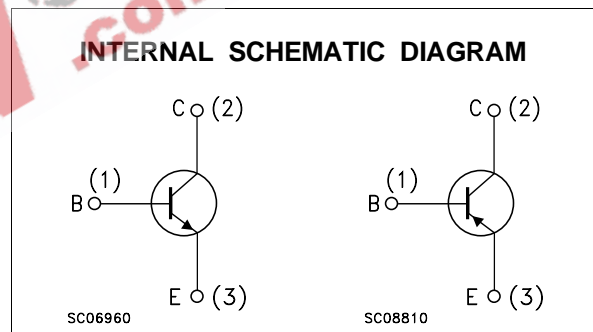
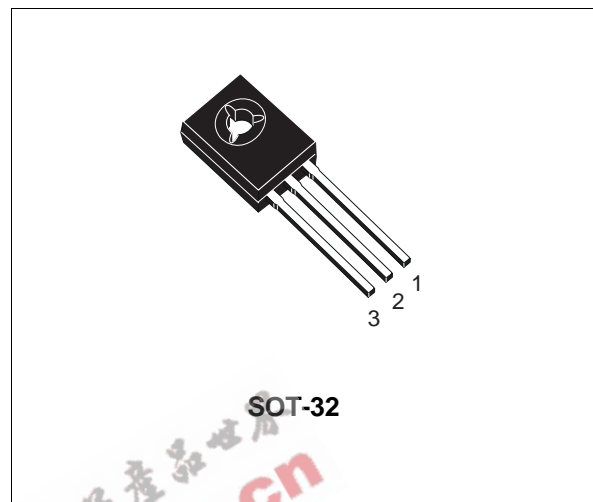

ABSOLUTE MAXIMUM RATINGS

Symbol	Parameter	Value		Unit
		NPN	MJE340	
		PNP	MJE350	
V_{CEO}	Collector-Emitter Voltage ($I_B = 0$)		300	V
V_{EBO}	Emitter-Base Voltage ($I_C = 0$)		3	V
I_C	Collector Current		0.5	A
P_{tot}	Total Power Dissipation at $T_{case} \leq 25^\circ\text{C}$		20.8	W
T_{stg}	Storage Temperature		-65 to 150	$^\circ\text{C}$
T_j	Max Operating Junction Temperature		150	$^\circ\text{C}$

For PNP types voltage and current values are negative.

MJE340 / MJE350

THERMAL DATA

R _{thj-case}	Thermal Resistance Junction-case	Max	6.0	°C/W
-----------------------	----------------------------------	-----	-----	------

ELECTRICAL CHARACTERISTICS (T_{case} = 25 °C unless otherwise specified)

Symbol	Parameter	Test Conditions	Min.	Typ.	Max.	Unit
I _{CBO}	Collector Cut-off Current (I _E = 0)	V _{CB} = 300 V			100	μA
I _{EBO}	Emitter Cut-off Current (I _C = 0)	V _{EB} = 3 V			100	μA
V _{CEO(sus)*}	Collector-Emitter Sustaining Voltage (I _B = 0)	I _C = 1 mA	300			V
h _{FE}	DC Current Gain	I _C = 50 mA V _{CE} = 10 V	30		240	

* Pulsed: Pulse duration = 300μs, duty cycle ≤ 2%

Safe Operating Area

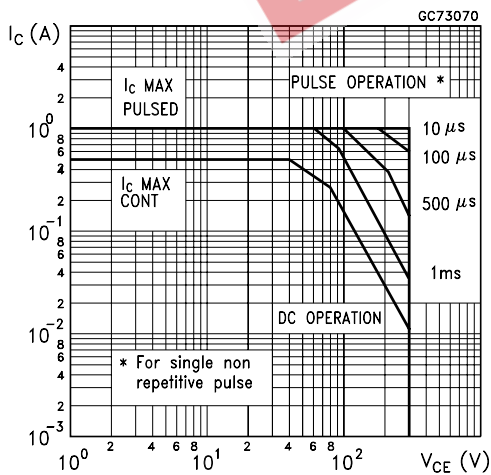

Derating Curve

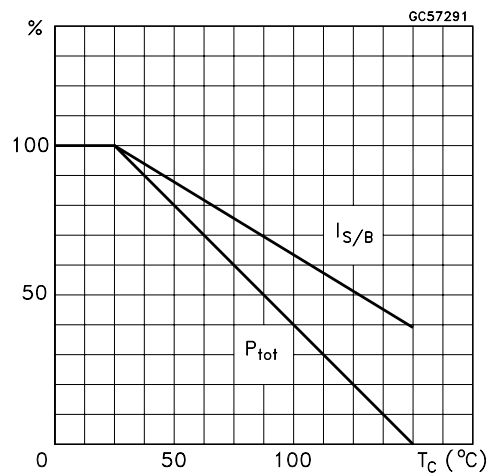

DC Current Gain (NPN type)

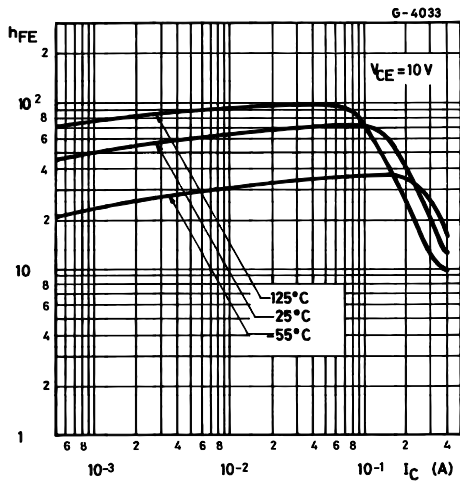

DC Current Gain (PNP type)

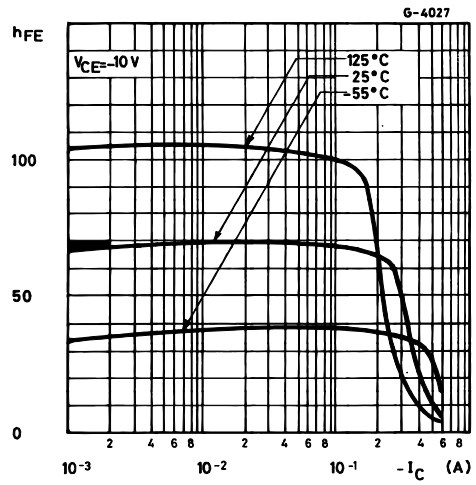

Collector-Emitter Saturation Voltage (NPN type)

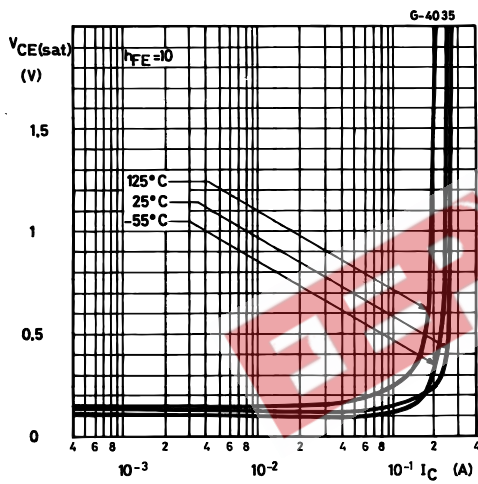

Collector-Emitter Saturation Voltage (PNP type)

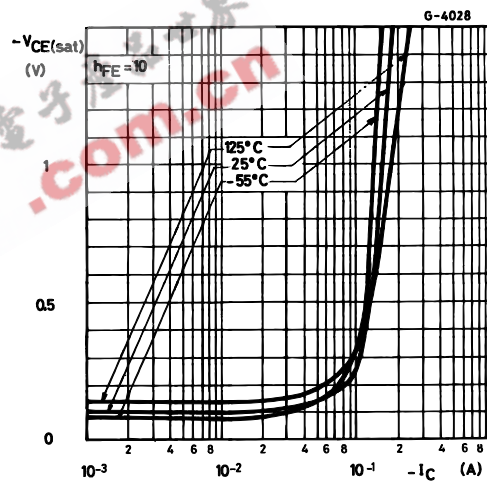

SOT-32 (TO-126) MECHANICAL DATA

DIM.	mm			inch		
	MIN.	TYP.	MAX.	MIN.	TYP.	MAX.
A	7.4		7.8	0.291		0.307
B	10.5		10.8	0.413		0.425
b	0.7		0.9	0.028		0.035
b1	0.40		0.65	0.015		0.025
C	2.4		2.7	0.094		0.106
c1	1.0		1.3	0.039		0.051
D	15.4		16.0	0.606		0.630
e		2.2			0.087	
e3		4.4			0.173	
F		3.8			0.150	
G	3		3.2	0.118		0.126
H			2.54			0.100
H2		2.15			0.084	
I		1.27			0.05	
O		0.3			0.011	
V		10°			10°	

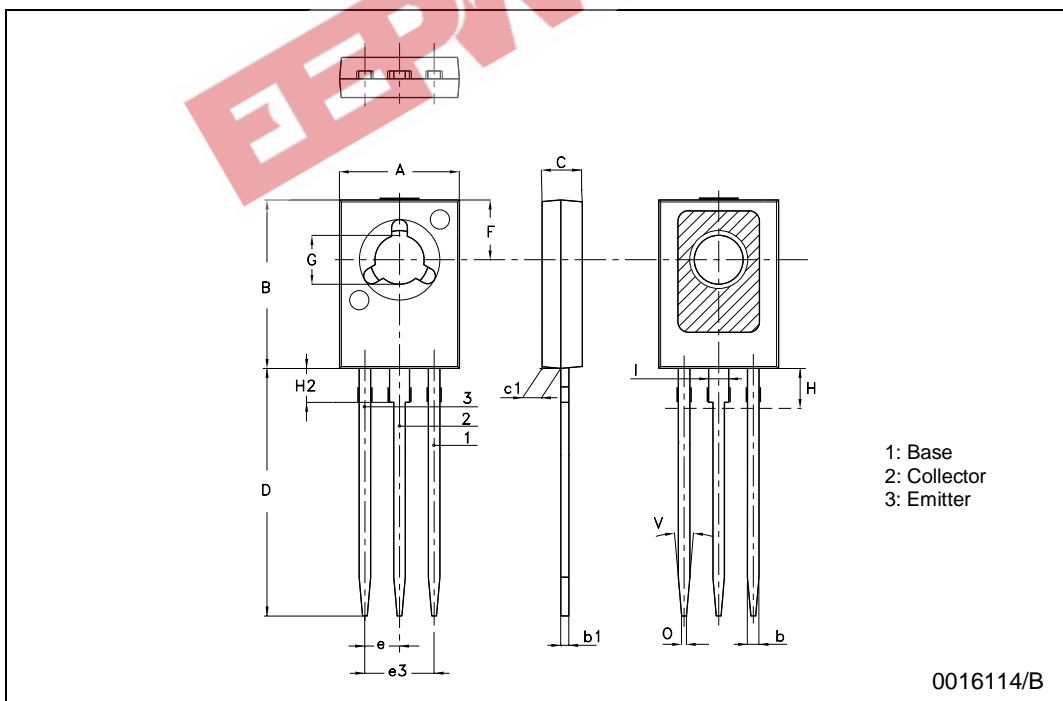



Information furnished is believed to be accurate and reliable. However, STMicroelectronics assumes no responsibility for the consequences of use of such information nor for any infringement of patents or other rights of third parties which may result from its use. No license is granted by implication or otherwise under any patent or patent rights of STMicroelectronics. Specification mentioned in this publication are subject to change without notice. This publication supersedes and replaces all information previously supplied. STMicroelectronics products are not authorized for use as critical components in life support devices or systems without express written approval of STMicroelectronics.

The ST logo is a trademark of STMicroelectronics

© 2003 STMicroelectronics – Printed in Italy – All Rights Reserved
STMicroelectronics GROUP OF COMPANIES

Australia - Brazil - Canada - China - Finland - France - Germany - Hong Kong - India - Israel - Italy - Japan - Malaysia - Malta - Morocco -
Singapore - Spain - Sweden - Switzerland - United Kingdom - United States.

<http://www.st.com>