

# Plastic Darlington Complementary Silicon Power Transistors

... designed for general-purpose amplifier and low-speed switching applications.

- High DC Current Gain —  
h<sub>FE</sub> = 2000 (Typ) @ I<sub>C</sub> = 2.0 Adc
- Monolithic Construction with Built-in Base-Emitter Resistors to Limit Leakage Multiplication
- Choice of Packages —  
MJE700 and MJE800 series  
T0220AB, MJE700T and MJE800T

## MAXIMUM RATINGS

Rating	Symbol	MJE700,T MJE800,T	MJE702 MJE703 MJE802 MJE803	Unit
Collector-Emitter Voltage	V <sub>CEO</sub>	60	80	V <sub>dc</sub>
Collector-Base Voltage	V <sub>CB</sub>	60	80	V <sub>dc</sub>
Emitter-Base Voltage	V <sub>EB</sub>	5.0		V <sub>dc</sub>
Collector Current	I <sub>C</sub>	4.0		A <sub>dc</sub>
Base Current	I <sub>B</sub>	0.1		A <sub>dc</sub>
Total Power Dissipation @ T <sub>C</sub> = 25°C Derate above 25°C	P <sub>D</sub>	CASE 77	TO-220	Watts W/°C
		40 0.32	50 0.40	
Operating and Storage Junction Temperature Range	T <sub>J</sub> , T <sub>stg</sub>	-55 to +150		°C

## THERMAL CHARACTERISTICS

Characteristic	Symbol	Max	Unit
Thermal Resistance, Junction to Case CASE 77 TO-220	R <sub>θJC</sub>	3.13 2.50	°C/W

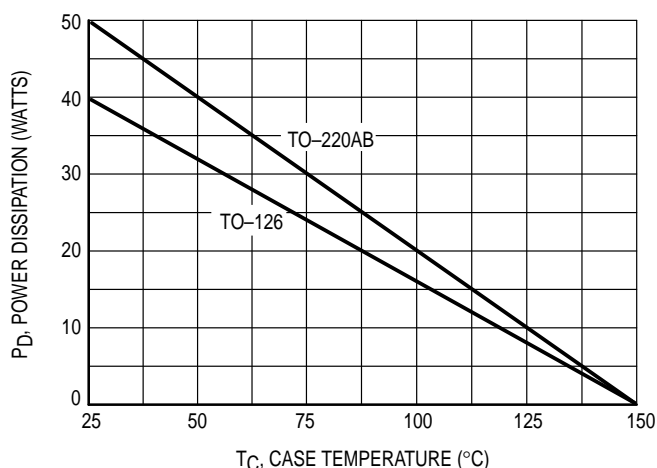
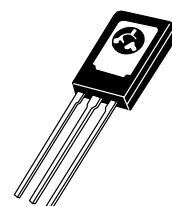


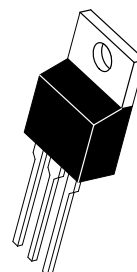
Figure 1. Power Derating

**PNP**  
**MJE700,T**  
**MJE702**  
**MJE703**  
**NPN**  
**MJE800,T**  
**MJE802**  
**MJE803**

**4.0 AMPERE**  
**DARLINGTON**  
**POWER TRANSISTORS**  
**COMPLEMENTARY**  
**SILICON**  
**40 WATT**  
**50 WATT**



**CASE 77-08**  
**TO-225AA TYPE**  
**MJE700-703**  
**MJE800-803**



**CASE 221A-06**  
**TO-220AB**  
**MJE700T**  
**MJE800T**

# MJE700,T MJE702 MJE703 MJE800,T MJE802 MJE803

## ELECTRICAL CHARACTERISTICS (T<sub>C</sub> = 25°C unless otherwise noted)

Characteristic	Symbol	Min	Max	Unit
<b>OFF CHARACTERISTICS</b>				
Collector–Emitter Breakdown Voltage (1) (I <sub>C</sub> = 50 mAdc, I <sub>B</sub> = 0)	V <sub>(BR)CEO</sub>	60 80	—	Vdc
Collector Cutoff Current (V <sub>CE</sub> = 60 Vdc, I <sub>B</sub> = 0) (V <sub>CE</sub> = 80 Vdc, I <sub>B</sub> = 0)	I <sub>CEO</sub>	—	100	μAdc
Collector Cutoff Current (V <sub>CB</sub> = Rated BV <sub>CEO</sub> , I <sub>E</sub> = 0) (V <sub>CB</sub> = Rated BV <sub>CEO</sub> , I <sub>E</sub> = 0, T <sub>C</sub> = 100°C)	I <sub>CBO</sub>	—	100 500	μAdc
Emitter Cutoff Current (V <sub>BE</sub> = 5.0 Vdc, I <sub>C</sub> = 0)	I <sub>EBO</sub>	—	2.0	mAdc

## ON CHARACTERISTICS

DC Current Gain (1) (I <sub>C</sub> = 1.5 Adc, V <sub>CE</sub> = 3.0 Vdc) (I <sub>C</sub> = 2.0 Adc, V <sub>CE</sub> = 3.0 Vdc) (I <sub>C</sub> = 4.0 Adc, V <sub>CE</sub> = 3.0 Vdc)	h <sub>FE</sub>	750 750 100	—	—
Collector–Emitter Saturation Voltage (1) (I <sub>C</sub> = 1.5 Adc, I <sub>B</sub> = 30 mAdc) (I <sub>C</sub> = 2.0 Adc, I <sub>B</sub> = 40 mAdc) (I <sub>C</sub> = 4.0 Adc, I <sub>B</sub> = 40 mAdc)	V <sub>CE(sat)</sub>	— — —	2.5 2.8 3.0	Vdc
Base–Emitter On Voltage (1) (I <sub>C</sub> = 1.5 Adc, V <sub>CE</sub> = 3.0 Vdc) (I <sub>C</sub> = 2.0 Adc, V <sub>CE</sub> = 3.0 Vdc) (I <sub>C</sub> = 4.0 Adc, V <sub>CE</sub> = 3.0 Vdc)	V <sub>BE(on)</sub>	— — —	2.5 2.5 3.0	Vdc

## DYNAMIC CHARACTERISTICS

Small–Signal Current Gain (I <sub>C</sub> = 1.5 Adc, V <sub>CE</sub> = 3.0 Vdc, f = 1.0 MHz)	h <sub>fe</sub>	1.0	—	—
--	-----------------	-----	---	---

(1) Pulse Test: Pulse Width ≤ 300 μs, Duty Cycle ≤ 2.0%.

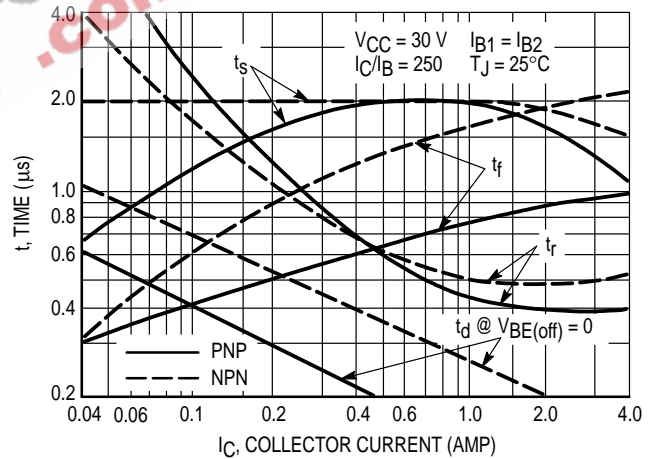
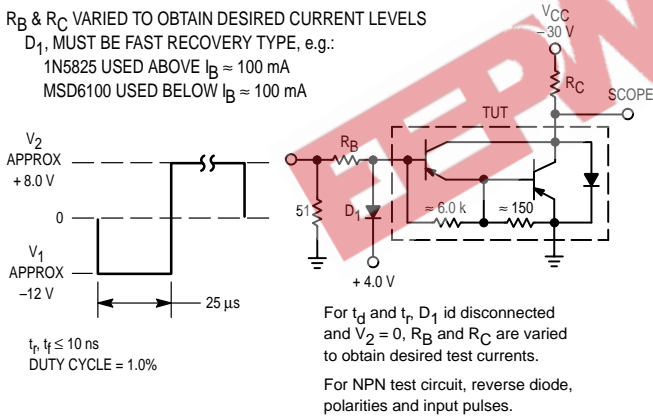


Figure 2. Switching Times Test Circuit

Figure 3. Switching Times

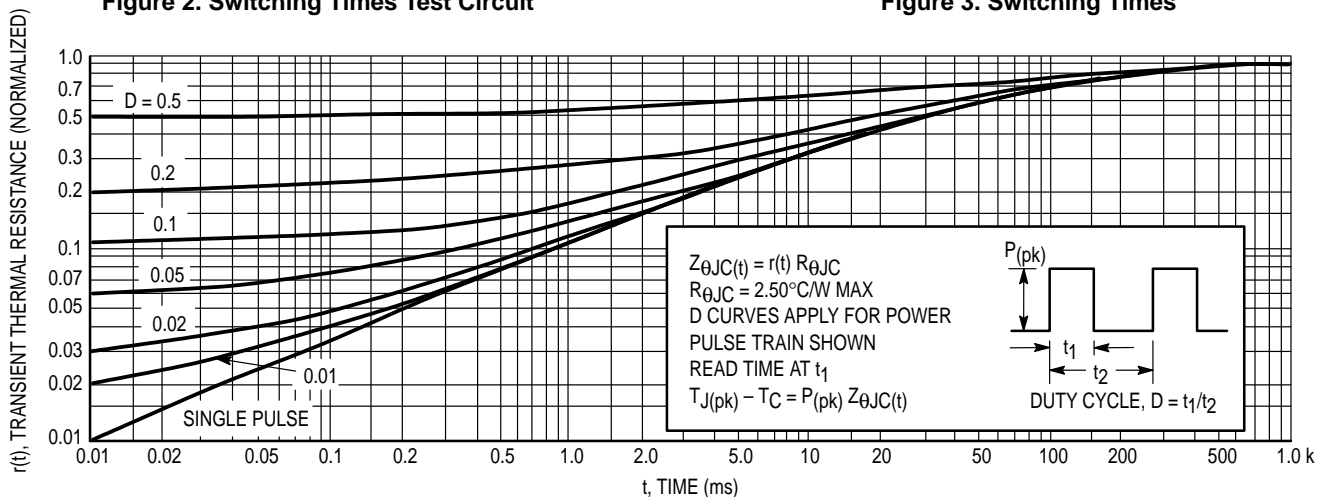
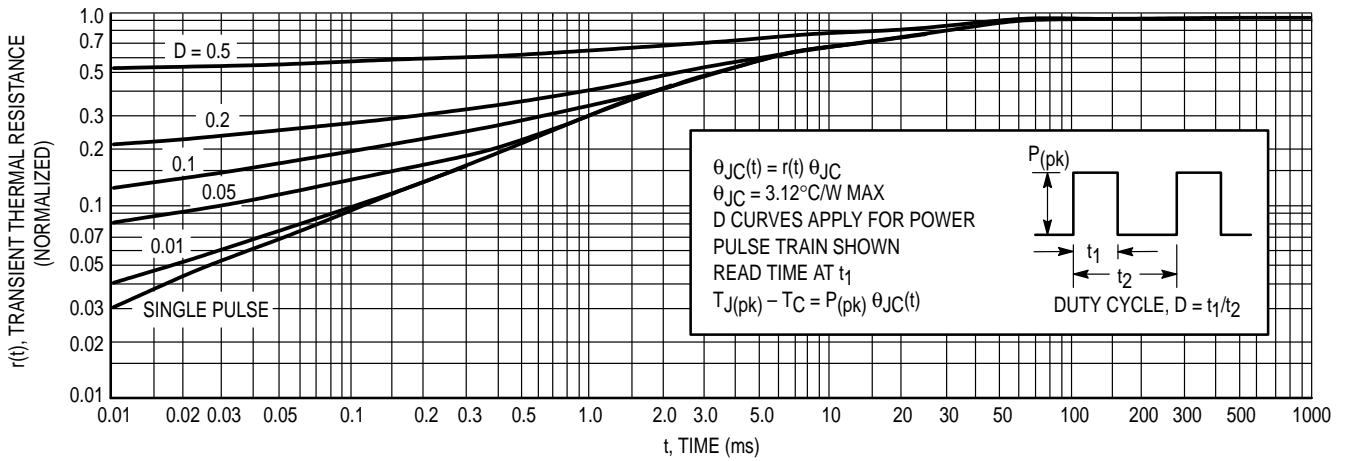


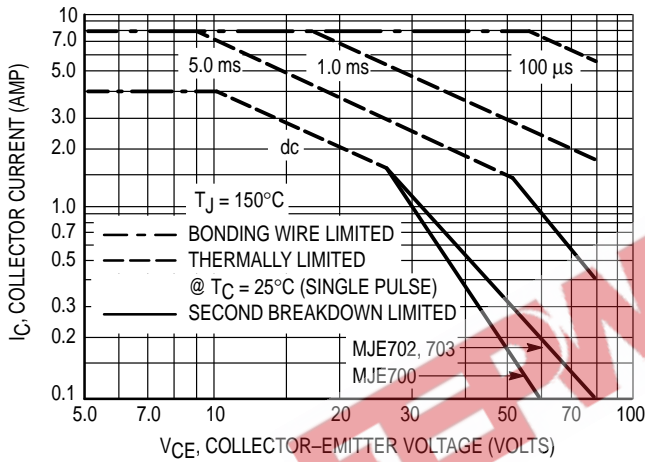
Figure 4. Thermal Response (MJE700T, 800T Series)

**MJE700,T MJE702 MJE703 MJE800,T MJE802 MJE803**

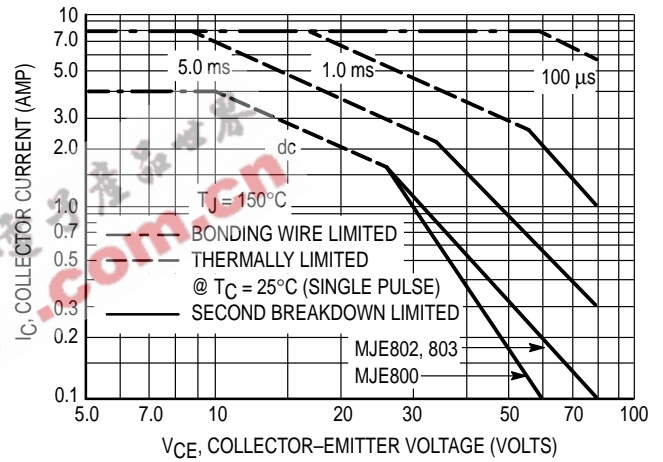


**Figure 5. Thermal Response (MJE700, 800 Series)**

**ACTIVE-REGION SAFE-OPERATING AREA**



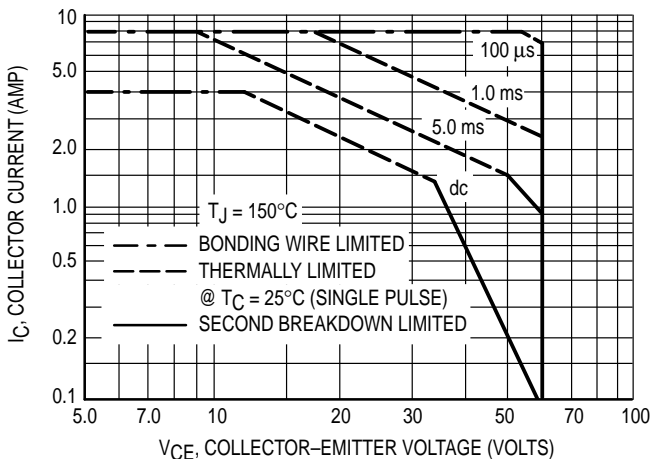
**Figure 6. MJE700 Series**



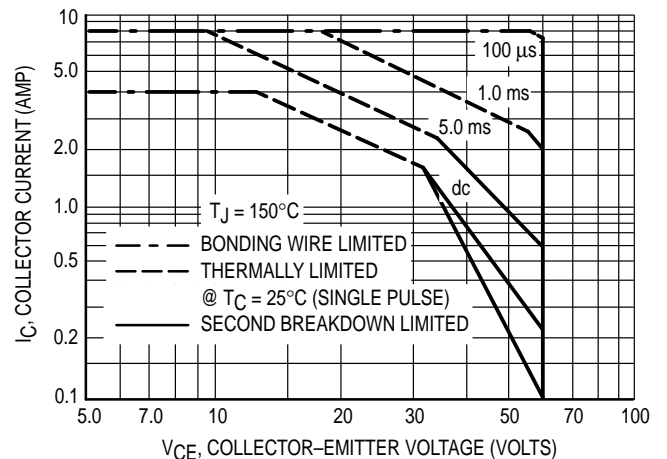
**Figure 7. MJE800 Series**

There are two limitations on the power handling ability of a transistor: average junction temperature and second breakdown. Safe operating area curves indicate  $I_C - V_{CE}$  limits of the transistor that must be observed for reliable operation; i.e., the transistor must not be subjected to greater dissipation than the curves indicate.

The data of Figures 6 and 7 are based on  $T_{J(pk)} = 150^\circ\text{C}$ ;  $T_C$  is variable depending on conditions. Second breakdown pulse limits are valid for duty cycles to 10% provided  $T_{J(pk)} < 150^\circ\text{C}$ .  $T_{J(pk)}$  may be calculated from the data in Figure 4 or 5. At high case temperatures, thermal limitations will reduce the power that can be handled to values less than the limitations imposed by second breakdown.

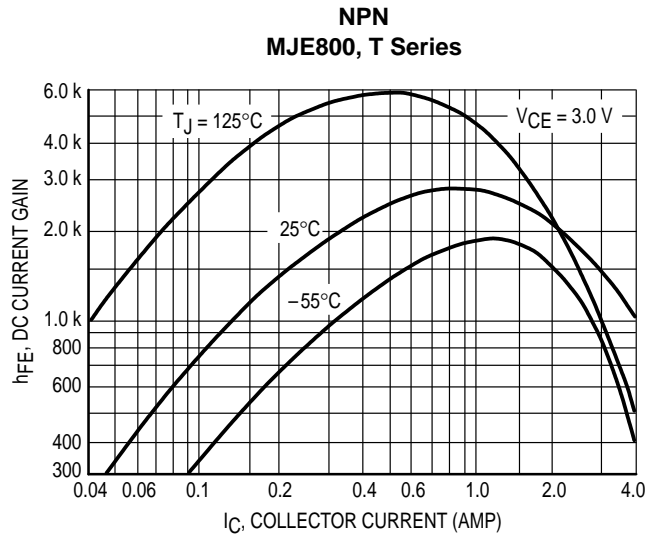
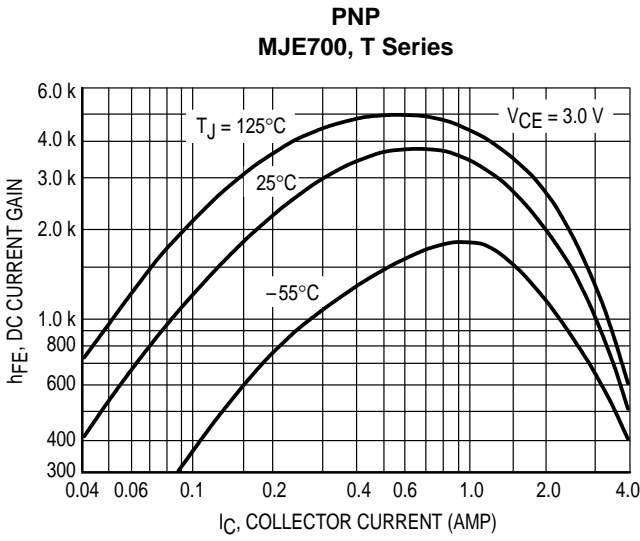


**Figure 8. MJE700T**

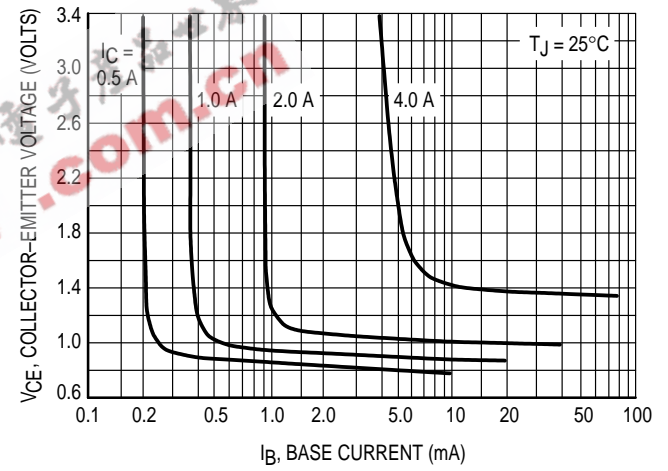
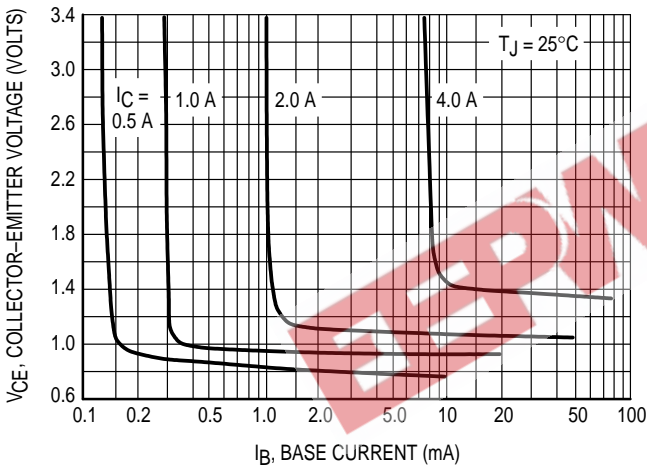


**Figure 9. MJE800T**

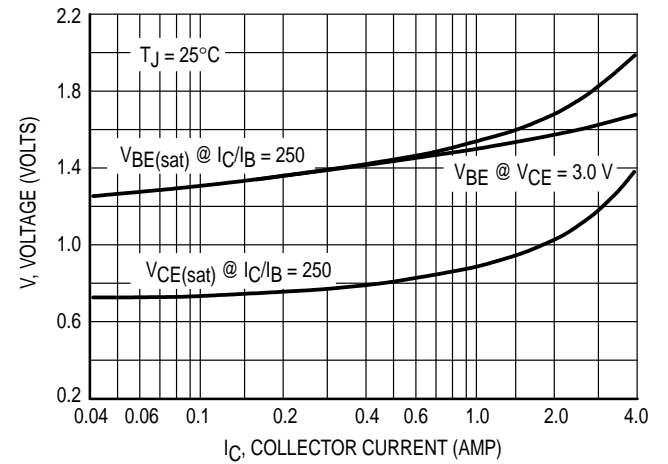
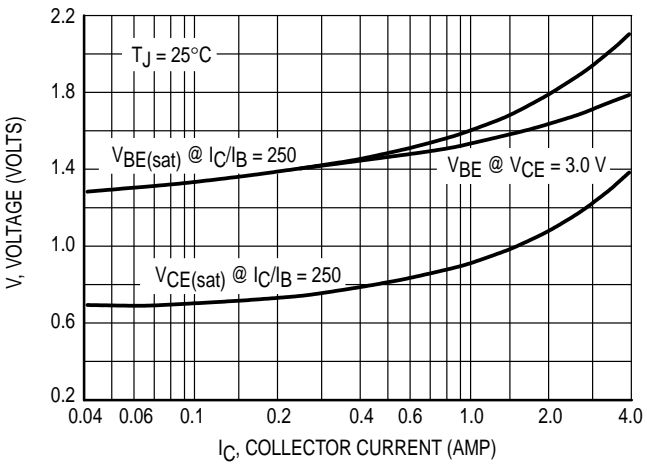
**MJE700,T MJE702 MJE703 MJE800,T MJE802 MJE803**



**Figure 10. DC Current Gain**

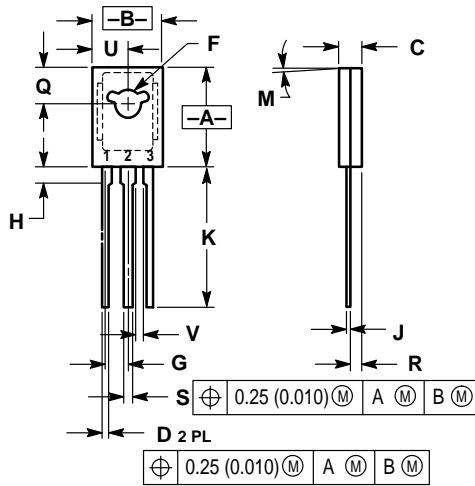


**Figure 11. Collector Saturation Region**



**Figure 12. "On" Voltages**

**MJE700,T MJE702 MJE703 MJE800,T MJE802 MJE803**  
**PACKAGE DIMENSIONS**



- NOTES:  
 1. DIMENSIONING AND TOLERANCING PER ANSI Y14.5M, 1982.  
 2. CONTROLLING DIMENSION: INCH.

DIM	INCHES		MILLIMETERS	
	MIN	MAX	MIN	MAX
A	0.425	0.435	10.80	11.04
B	0.295	0.305	7.50	7.74
C	0.095	0.105	2.42	2.66
D	0.020	0.026	0.51	0.66
F	0.115	0.130	2.93	3.30
G	0.094 BSC		2.39 BSC	
H	0.050	0.095	1.27	2.41
J	0.015	0.025	0.39	0.63
K	0.575	0.655	14.61	16.63
M	5° TYP		5° TYP	
Q	0.148	0.158	3.76	4.01
R	0.045	0.055	1.15	1.39
S	0.025	0.035	0.64	0.88
U	0.145	0.155	3.69	3.93
V	0.040	—	1.02	—

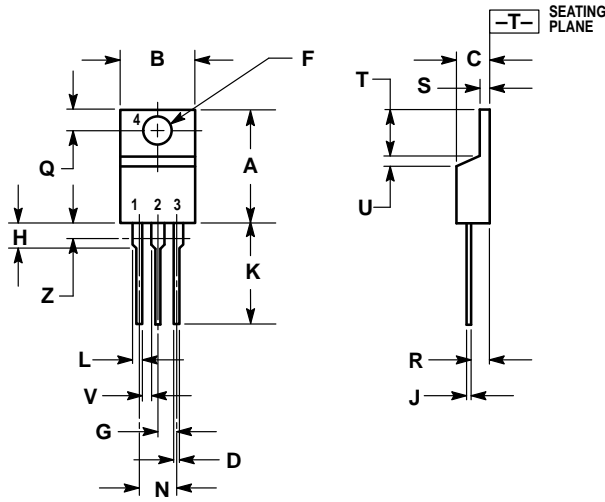
- STYLE 1:  
 PIN 1. EMITTER  
 2. COLLECTOR  
 3. BASE

EFPW.com.cn 电子产品世界

**CASE 77-08**  
**TO-225AA TYPE**  
**ISSUE V**

**MJE700,T MJE702 MJE703 MJE800,T MJE802 MJE803**

**PACKAGE DIMENSIONS — CONTINUED**



- NOTES:
1. DIMENSIONING AND TOLERANCING PER ANSI Y14.5M, 1982.
  2. CONTROLLING DIMENSION: INCH.
  3. DIMENSION Z DEFINES A ZONE WHERE ALL BODY AND LEAD IRREGULARITIES ARE ALLOWED.

DIM	INCHES		MILLIMETERS	
	MIN	MAX	MIN	MAX
A	0.570	0.620	14.48	15.75
B	0.380	0.405	9.66	10.28
C	0.160	0.190	4.07	4.82
D	0.025	0.035	0.64	0.88
F	0.142	0.147	3.61	3.73
G	0.095	0.105	2.42	2.66
H	0.110	0.155	2.80	3.93
J	0.018	0.025	0.46	0.64
K	0.500	0.562	12.70	14.27
L	0.045	0.060	1.15	1.52
N	0.190	0.210	4.83	5.33
Q	0.100	0.120	2.54	3.04
R	0.080	0.110	2.04	2.79
S	0.045	0.055	1.15	1.39
T	0.235	0.255	5.97	6.47
U	0.000	0.050	0.00	1.27
V	0.045	—	1.15	—
Z	—	0.080	—	2.04

- STYLE 1:  
 PIN 1. BASE  
 2. COLLECTOR  
 3. EMITTER  
 4. COLLECTOR

**CASE 221A-06  
 TO-220AB  
 ISSUE Y**

Motorola reserves the right to make changes without further notice to any products herein. Motorola makes no warranty, representation or guarantee regarding the suitability of its products for any particular purpose, nor does Motorola assume any liability arising out of the application or use of any product or circuit, and specifically disclaims any and all liability, including without limitation consequential or incidental damages. "Typical" parameters can and do vary in different applications. All operating parameters, including "Typicals" must be validated for each customer application by customer's technical experts. Motorola does not convey any license under its patent rights nor the rights of others. Motorola products are not designed, intended, or authorized for use as components in systems intended for surgical implant into the body, or other applications intended to support or sustain life, or for any other application in which the failure of the Motorola product could create a situation where personal injury or death may occur. Should Buyer purchase or use Motorola products for any such unintended or unauthorized application, Buyer shall indemnify and hold Motorola and its officers, employees, subsidiaries, affiliates, and distributors harmless against all claims, costs, damages, and expenses, and reasonable attorney fees arising out of, directly or indirectly, any claim of personal injury or death associated with such unintended or unauthorized use, even if such claim alleges that Motorola was negligent regarding the design or manufacture of the part. Motorola and are registered trademarks of Motorola, Inc. Motorola, Inc. is an Equal Opportunity/Affirmative Action Employer.

**How to reach us:**  
**USA / EUROPE:** Motorola Literature Distribution;  
 P.O. Box 20912; Phoenix, Arizona 85036. 1-800-441-2447

**JAPAN:** Nippon Motorola Ltd.; Tatsumi-SPD-JLDC, Toshikatsu Otsuki,  
 6F Seibu-Butsuryu-Center, 3-14-2 Tatsumi Koto-Ku, Tokyo 135, Japan. 03-3521-8315

**MFAX:** RMFAX0@email.sps.mot.com – TOUCHTONE (602) 244-6609  
**INTERNET:** http://Design-NET.com

**HONG KONG:** Motorola Semiconductors H.K. Ltd.; 8B Tai Ping Industrial Park,  
 51 Ting Kok Road, Tai Po, N.T., Hong Kong. 852-26629298

