



MMBTH10

NPN SILICON TRANSISTOR

RF TRANSISTOR

DESCRIPTION

The UTC **MMBTH10** is designed for using as VHF and UHF oscillators and VHF Mixer in a tuner of a TV receiver.

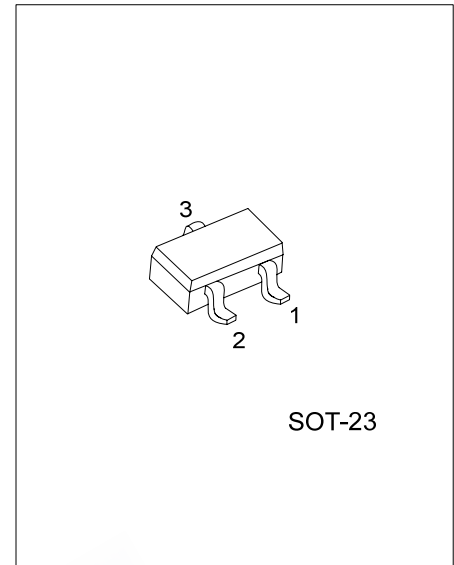

*Pb-free plating product number: MMBTH10L

ORDERING INFORMATION

Order Number		Package	Pin Assignment			Packing
Normal	Lead Free Plating		1	2	3	
MMBTH10-x-AE3-C-R	MMBTH10L-x-AE3-C-R	SOT-23	E	B	C	Tape Reel

<p>MMBTH10L-x-AE3-C-R</p> <p>(1) Packing Type (2) Pin Assignment (3) Package Type (4) Rank (5) Lead Plating</p>	<p>(1) T: Tube (2) refer to Pin Assignment (3) AE3: SOT-23 (4) x: refer to Classification of h_{FE} (5) L: Lead Free Plating, Blank: Pb/Sn</p>
---	---

MARKING

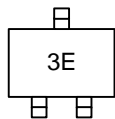

MMBTH10

NPN SILICON TRANSISTOR

■ ABSOLUTE MAXIMUM RATING (Ta=25°C)

PARAMETER	SYMBOL	RATINGS	UNIT
Collector-base voltage	V _{CB0}	30	V
Collector-emitter voltage	V _{CEO}	25	V
Emitter-base voltage	V _{EBO}	3	V
Total Power Dissipation	P _C	225	mW
Collector current	I _C	50	mA
Junction Temperature	T _J	150	°C
Storage Temperature	T _{STG}	-55 ~ +150	°C

Note Absolute maximum ratings are those values beyond which the device could be permanently damaged. Absolute maximum ratings are stress ratings only and functional device operation is not implied.

■ ELECTRICAL CHARACTERISTICS (Ta=25°C, unless otherwise specified)

PARAMETER	SYMBOL	TEST CONDITIONS	MIN	TYP	MAX	UNIT
Collector-Base Breakdown Voltage	BV _{CB0}	I _C =100μA	30			V
Collector-Emitter Breakdown Voltage	BV _{CEO}	I _C =1mA	25			V
Emitter-Base Breakdown Voltage	BV _{EBO}	I _E =10μA	3			V
Collector-Emitter Saturation Voltage	V _{CE(SAT)}	I _C =4mA, I _B =400μA			500	mV
Base-Emitter on Voltage	V _{BE(ON)}	V _{CE} =10V, I _C =4mA			950	mV
Collector Cut-off Current	I _{CB0}	V _{CB} =25V			100	nA
Emitter Cut-off Current	I _{EBO}	V _{EB} =2V			100	nA
DC Current Gain	h _{FE}	V _{CE} =10V, I _C =4mA	60			
Output Capacitance	C _{ob}	V _{CB} =10V, f=1MHz			0.7	pF
Current Gain Bandwidth Product	f _T	V _{CE} =10V, I _C =4mA, f=100MHz	650			MHz

■ CLASSIFICATION OF h_{FE}

RANK	A	B	C
RANGE	60-100	90-130	120-200

TYPICAL CHARACTERISTICS

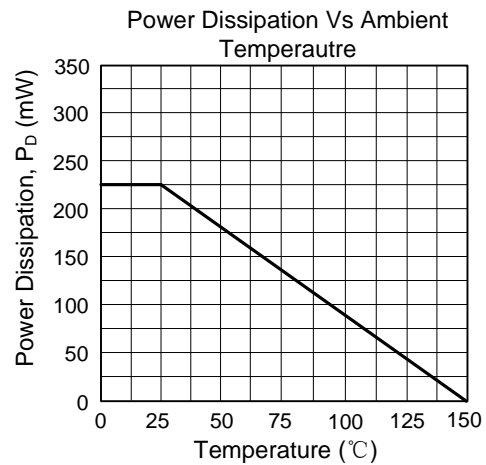
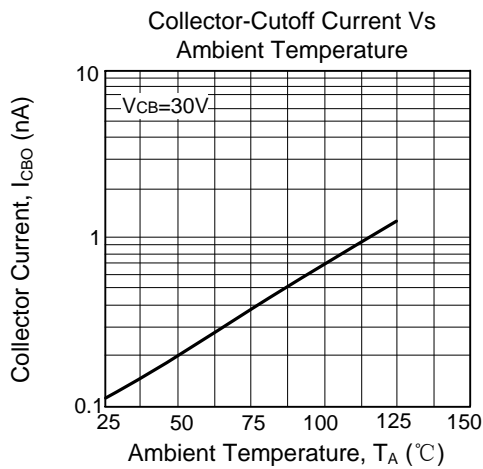
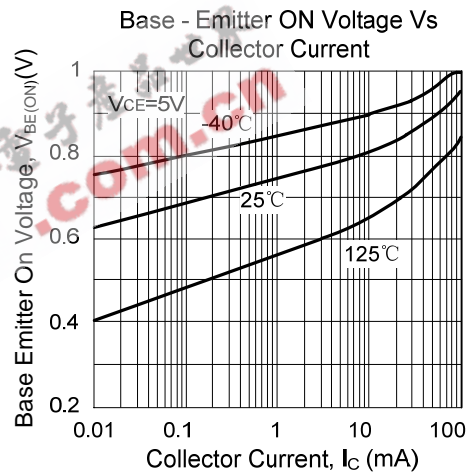
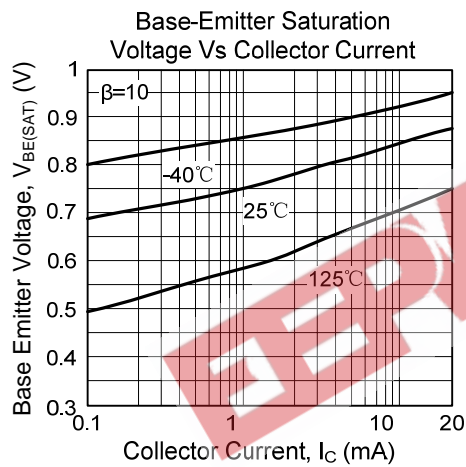
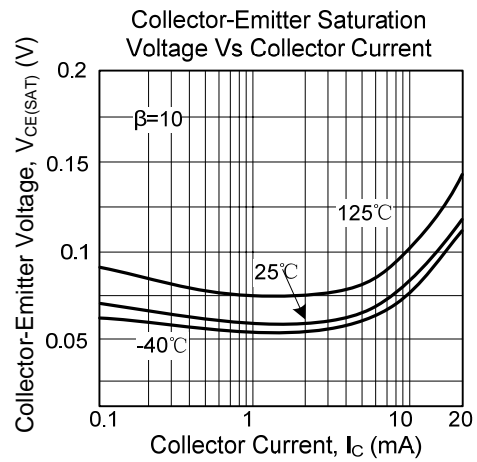
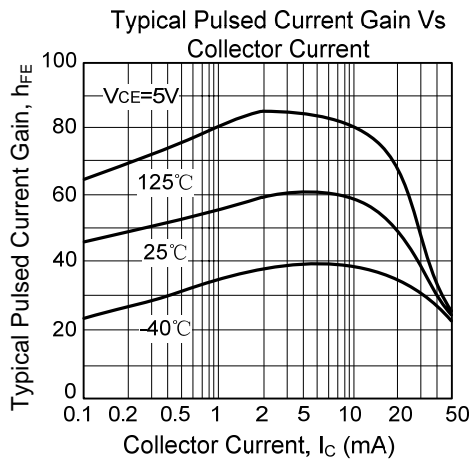

■ TYPICAL CHARACTERISTICS(Cont.)

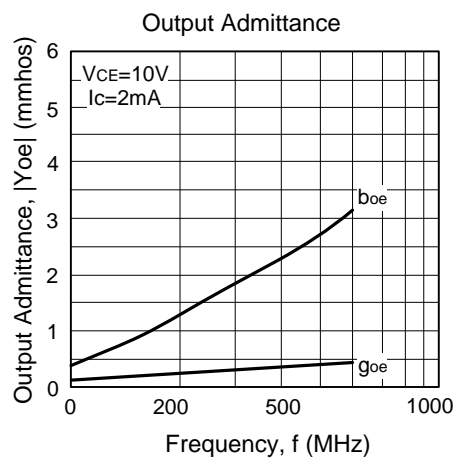
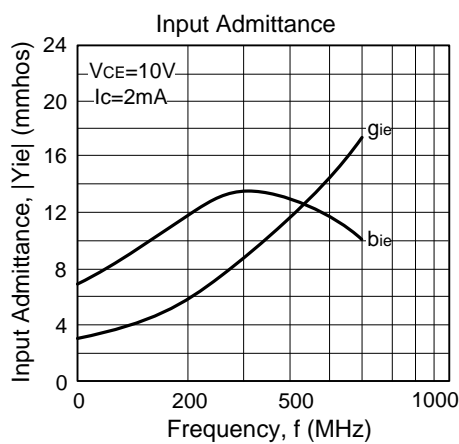
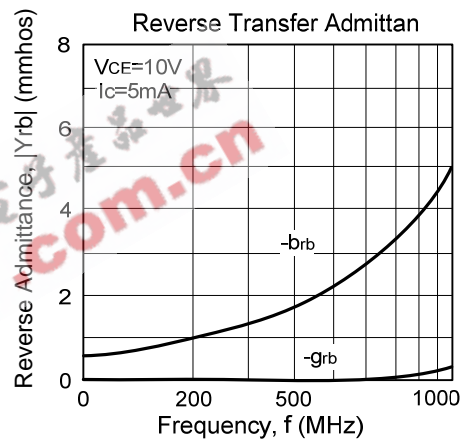
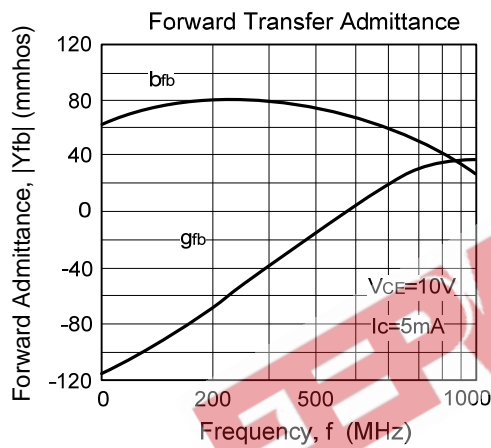
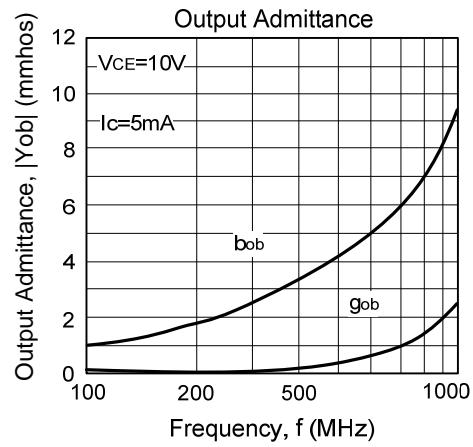
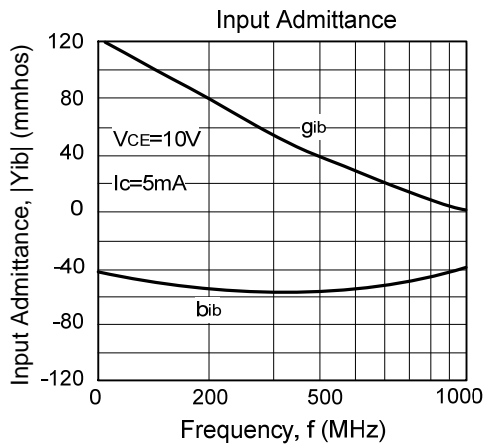

■ TYPICAL CHARACTERISTICS(Cont.)

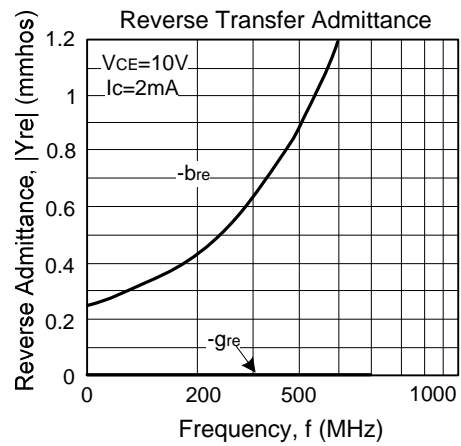
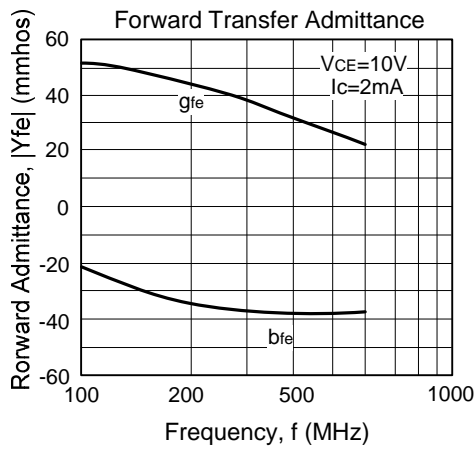

EEPW.com.cn 电子产品世界

UTC assumes no responsibility for equipment failures that result from using products at values that exceed, even momentarily, rated values (such as maximum ratings, operating condition ranges, or other parameters) listed in products specifications of any and all UTC products described or contained herein. UTC products are not designed for use in life support appliances, devices or systems where malfunction of these products can be reasonably expected to result in personal injury. Reproduction in whole or in part is prohibited without the prior written consent of the copyright owner. The information presented in this document does not form part of any quotation or contract, is believed to be accurate and reliable and may be changed without notice.