



**OPTICALLY COUPLED BILATERAL SWITCH LIGHT ACTIVATED ZERO VOLTAGE CROSSING TRIAC**

**DESCRIPTION**

The MOC308\_ Series are optically coupled isolators consisting of a Gallium Arsenide infrared emitting diode coupled with a monolithic silicon detector performing the functions of a zero crossing bilateral triac mounted in a standard 6 pin dual-in-line package.

**FEATURES**

- Options :-  
10mm lead spread - add G after part no.  
Surface mount - add SM after part no.  
Tape&reel - add SMT&R after part no.
- High Isolation Voltage (5.3kV<sub>RMS</sub>, 7.5kV<sub>PK</sub>)
- Zero Voltage Crossing
- 800V Peak Blocking Voltage
- All electrical parameters 100% tested
- Custom electrical selections available

**APPLICATIONS**

- CRTs
- Power Triac Driver
- Motors
- Consumer appliances
- Printers

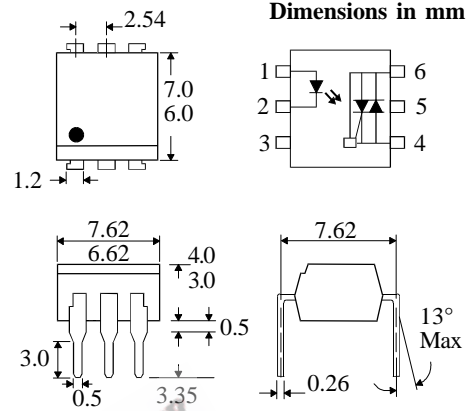

**ABSOLUTE MAXIMUM RATINGS**  
(25 °C unless otherwise noted)

Storage Temperature	-40°C - +150°C
Operating Temperature	-40°C - +100°C
Lead Soldering Temperature	260°C (1.6mm from case for 10 seconds)
Input-to-output Isolation Voltage (Pk)	7500 Vac (60 Hz , 1sec. duration)

**INPUT DIODE**

Forward Current	50mA
Reverse Voltage	6V
Power Dissipation	120mW (derate linearly 1.41mW/°C above 25°C)

**OUTPUT PHOTO TRIAC**

Off-State Output Terminal Voltage	800V
RMS Forward Current	100mA
Forward Current (Peak)	1.2A
Power Dissipation	150mW (derate linearly 1.76mW/°C above 25°C)

**POWER DISSIPATION**

Total Power Dissipation	250mW (derate linearly 2.94mW/°C above 25°C)
-------------------------	---

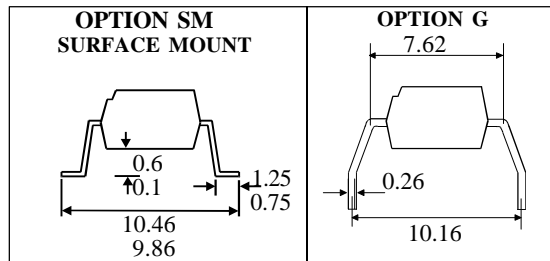

**ISOCOMCOMPONENTSLTD**  
Unit 25B, Park View Road West,  
Park View Industrial Estate, Brenda Road  
Hartlepool, TS25 1YD England Tel: (01429)863609  
Fax : (01429) 863581 e-mail sales@isocom.co.uk  
<http://www.isocom.com>

**ISOCOM INC**  
1024 S. Greenville Ave, Suite 240,  
Allen, TX 75002 USA  
Tel: (214)495-0755 Fax: (214)495-0901  
e-mail info@isocom.com  
<http://www.isocom.com>

**ELECTRICAL CHARACTERISTICS (  $T_A = 25^\circ\text{C}$  Unless otherwise noted )**

PARAMETER		MIN	TYP	MAX	UNITS	TEST CONDITION
Input	Forward Voltage ( $V_F$ ) Reverse Current ( $I_R$ )		1.2	1.5 100	V $\mu\text{A}$	$I_F = 30\text{mA}$ $V_R = 6\text{V}$
Output	Peak Off-state Current ( $I_{\text{DRM}}$ ) Peak Blocking Voltage ( $V_{\text{DRM}}$ ) On-state Voltage ( $V_{\text{TM}}$ )  Critical rate of rise of off-state Voltage ( $dv/dt$ )	800	1.8	300 3.0	nA V V	$V_{\text{DRM}} = 800\text{V}$ (note 1) $I_{\text{DRM}} = 300\text{nA}$ $I_{\text{TM}} = 100\text{mA}$ ( peak )
Coupled	Input Current to Trigger ( $I_{\text{FT}}$ )(note 2) MOC3080 MOC3081 MOC3082 MOC3083  Holding Current , either direction ( $I_H$ ) Input to Output Isolation Voltage $V_{\text{ISO}}$		100	30 15 10 5	mA mA mA mA  $\mu\text{A}$ $V_{\text{RMS}}$ $V_{\text{PK}}$	$V_{\text{TM}} = 3\text{V}$ ( note 2 )     See note 3 See note 3
Zero Crossing Charact- -eristic	Inhibit Voltage ( $V_{\text{IH}}$ )  Leakage in Inhibited State ( $I_S$ )			35 500	V $\mu\text{A}$	$I_F = \text{Rated } I_{\text{FT}}$ MT1-MT2 Voltage above which device will not trigger $I_F = \text{Rated } I_{\text{FT}}$ $V_{\text{DRM}} = 800\text{V}$ off-state

Note 1. Guaranteed to trigger at an  $I_F$  value less than or equal to max.  $I_{\text{FT}}$ , recommended  $I_F$  lies between Rated  $I_{\text{FT}}$  and absolute max.  $I_F$ .

Note 2. Measured with input leads shorted together and output leads shorted together.

**RMS On-state Current vs. Ambient Temperature**

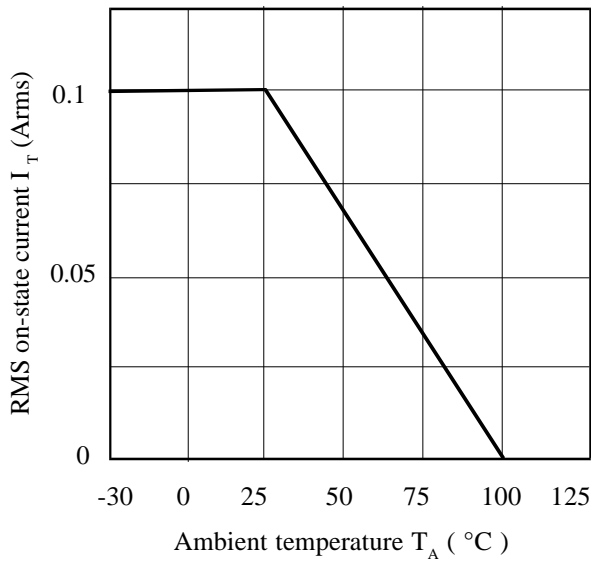

**Normalised Repetitive Peak Off-state Voltage vs. Ambient Temperature**

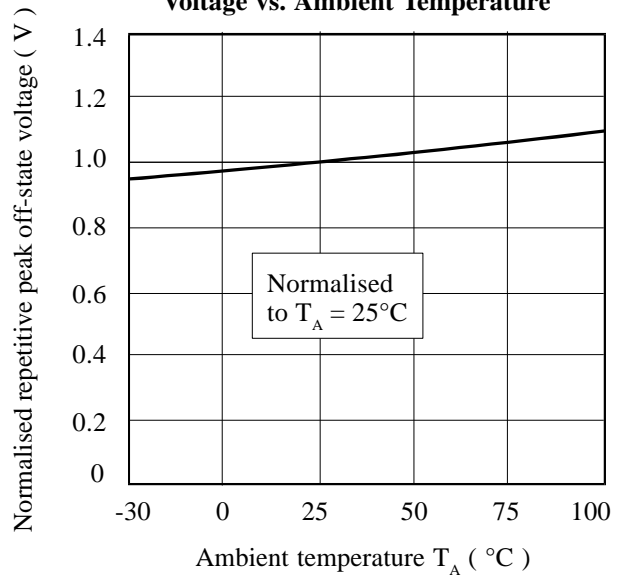

**Forward Current vs. Ambient Temperature**

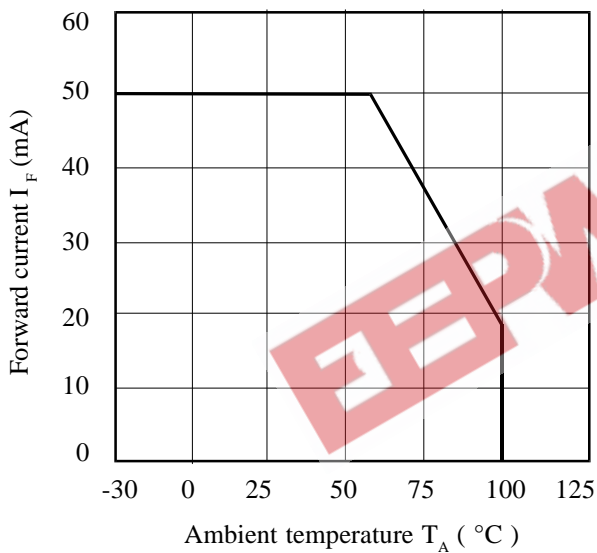

**On-state Voltage vs. Ambient Temperature**

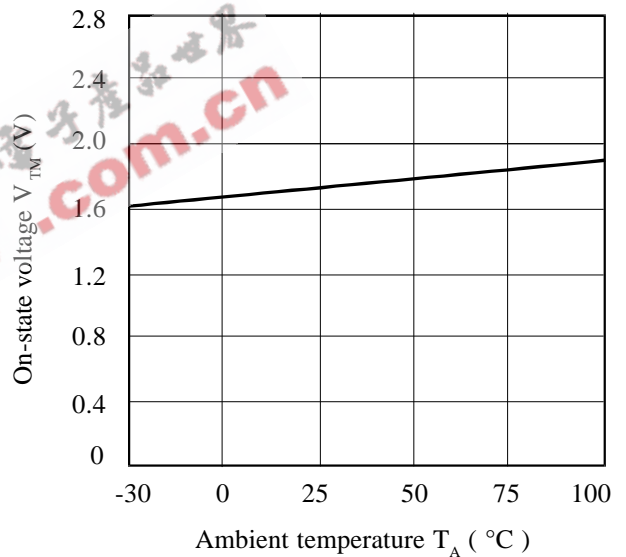

**Normalised Input Trigger Current vs. Ambient Temperature**

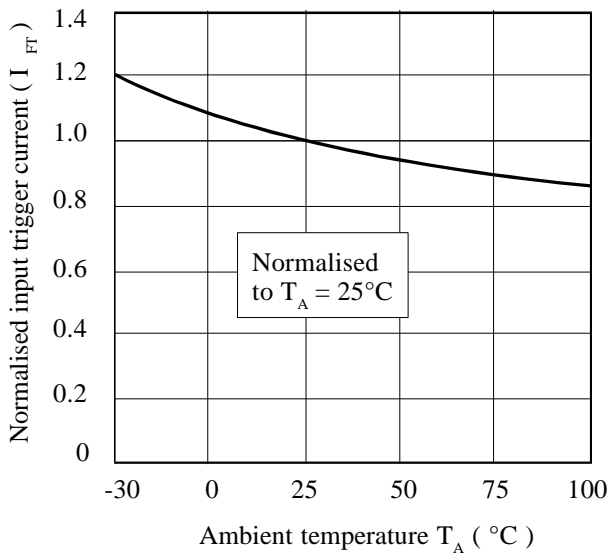

**On-state Current vs. On-state Voltage**

