

Cascadable Silicon Bipolar MMIC Amplifier

Technical Data

MSA-0186

Features

- **Cascadable 50 Ω Gain Block**
- **3 dB Bandwidth:**
DC to 0.9 GHz
- **High Gain:**
17.5 dB Typical at 0.5 GHz
- **Unconditionally Stable**
($k > 1$)
- **Surface Mount Plastic Package**
- **Tape-and-Reel Packaging Option Available⁽¹⁾**

Note:

1. Refer to PACKAGING section "Tape-and-Reel Packaging for Semiconductor Devices".

Description

The MSA-0186 is a high performance silicon bipolar Monolithic Microwave Integrated Circuit (MMIC) housed in a low cost, surface mount plastic package. This MMIC is designed for use as a general purpose 50 Ω gain block. Typical applications include narrow and broad band IF and RF amplifiers in commercial and industrial applications.

The MSA-series is fabricated using HP's 10 GHz f_T , 25 GHz f_{MAX} , silicon bipolar MMIC process which uses nitride self-alignment,

86 Plastic Package

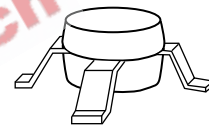

ion implantation, and gold metallization to achieve excellent performance, uniformity and reliability. The use of an external bias resistor for temperature and current stability also allows bias flexibility.

Typical Biasing Configuration

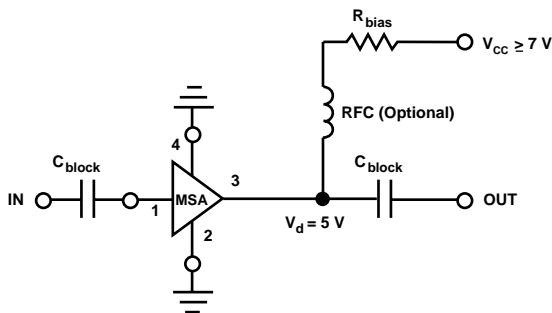

MSA-0186 Absolute Maximum Ratings

Parameter	Absolute Maximum ^[1]
Device Current	40 mA
Power Dissipation ^[2,3]	200 mW
RF Input Power	+13 dBm
Junction Temperature	150°C
Storage Temperature	-65 to 150°C

Thermal Resistance^[2,4]:

$$\theta_{jc} = 115^{\circ}\text{C/W}$$

Notes:

1. Permanent damage may occur if any of these limits are exceeded.
2. $T_{\text{CASE}} = 25^{\circ}\text{C}$.
3. Derate at 8.7 mW/°C for $T_{\text{C}} > 127^{\circ}\text{C}$.
4. See MEASUREMENTS section “Thermal Resistance” for more information.

Electrical Specifications^[1], $T_{\text{A}} = 25^{\circ}\text{C}$

Symbol	Parameters and Test Conditions: $I_{\text{d}} = 17 \text{ mA}$, $Z_{\text{o}} = 50 \Omega$	Units	Min.	Typ.	Max.
G _P	Power Gain ($ S_{21} ^2$) f = 0.1 GHz f = 0.5 GHz	dB	15.5	18.5 17.5	
ΔGP	Gain Flatness f = 0.1 to 0.6 GHz	dB		±0.7	
f _{3 dB}	3 dB Bandwidth	GHz		0.9	
VSWR	Input VSWR f = 0.1 to 3.0 GHz			1.3:1	
	Output VSWR f = 0.1 to 3.0 GHz			1.2:1	
NF	50 Ω Noise Figure f = 0.5 GHz	dB		5.5	
P _{1 dB}	Output Power at 1 dB Gain Compression f = 0.5 GHz	dBm		1.5	
IP ₃	Third Order Intercept Point f = 0.5 GHz	dBm		14.0	
t _D	Group Delay f = 0.5 GHz	psec		200	
V _d	Device Voltage	V	4.0	5.0	6.0
dV/dT	Device Voltage Temperature Coefficient	mV/°C		-9.0	

Note:

1. The recommended operating current range for this device is 13 to 25 mA. Typical performance as a function of current is on the following page.

Part Number Ordering Information

Part Number	No. of Devices	Container
MSA-0186-BLK	100	Antistatic Bag
MSA-0186-TR1	1000	7" Reel

For more information refer to PACKAGING section, “Tape and Reel Packaging for Semiconductor Devices.”

MSA-0186 Typical Scattering Parameters ($Z_0 = 50 \Omega$, $T_A = 25^\circ\text{C}$, $I_d = 17 \text{ mA}$)

Freq. GHz	S_{11}		S_{21}			S_{12}			S_{22}	
	Mag	Ang	dB	Mag	Ang	dB	Mag	Ang	Mag	Ang
0.1	.05	148	18.5	8.39	171	-23.0	.071	4	.08	-7
0.2	.06	124	18.3	8.22	162	-22.8	.073	9	.08	-14
0.3	.07	103	18.1	8.03	154	-22.6	.074	13	.07	-24
0.4	.08	89	17.7	7.67	146	-22.2	.078	14	.07	-31
0.5	.08	76	17.4	7.42	139	-21.9	.081	17	.06	-39
0.6	.09	66	17.0	7.06	131	-21.4	.085	21	.06	-47
0.8	.10	50	16.2	6.47	119	-20.5	.094	25	.07	-67
1.0	.10	35	15.3	5.83	107	-19.6	.105	29	.07	-89
1.5	.07	12	13.2	4.57	83	-17.7	.131	30	.08	-165
2.0	.02	-12	11.3	3.67	64	-16.1	.157	27	.08	156
2.5	.06	165	9.8	3.09	50	-14.8	.182	24	.08	134
3.0	.14	150	8.3	2.60	34	-13.9	.202	19	.09	124
3.5	.23	137	7.0	2.24	20	-13.4	.213	12	.09	117
4.0	.31	125	5.7	1.93	6	-13.0	.223	5	.09	114
5.0	.45	105	3.3	1.46	-17	-12.7	.231	-5	.09	132

A model for this device is available in the DEVICE MODELS section.

Typical Performance, $T_A = 25^\circ\text{C}$

(unless otherwise noted)

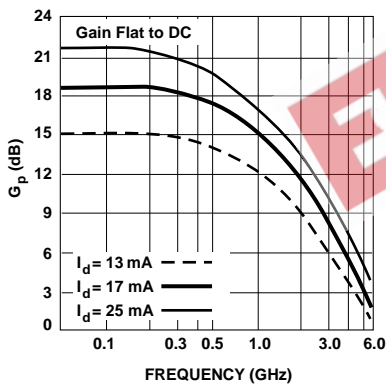

Figure 1. Typical Power Gain vs. Frequency, $T_A = 25^\circ\text{C}$, $I_d = 17 \text{ mA}$.

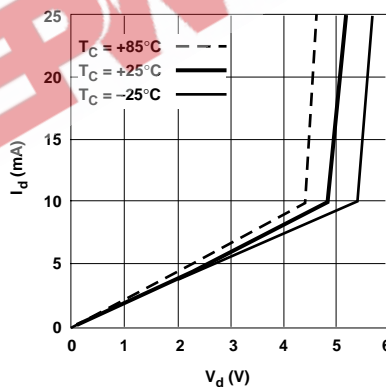

Figure 2. Device Current vs. Voltage.

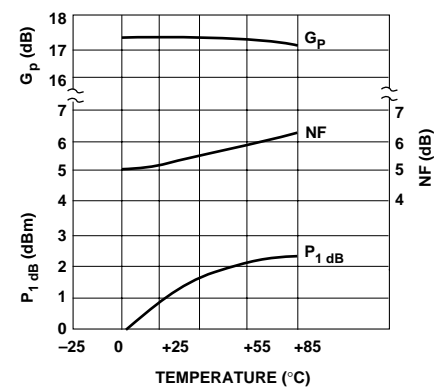

Figure 3. Output Power at 1 dB Gain Compression, NF and Power Gain vs. Case Temperature, $f = 0.5 \text{ GHz}$, $I_d = 17 \text{ mA}$.

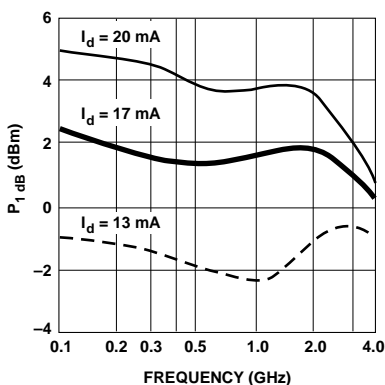

Figure 4. Output Power at 1 dB Gain Compression vs. Frequency.

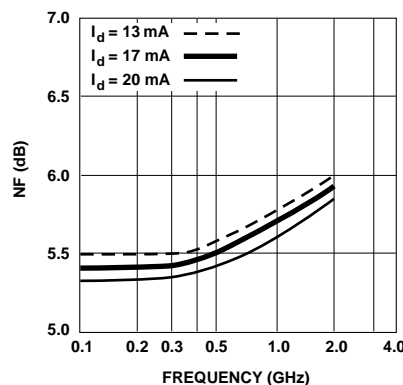
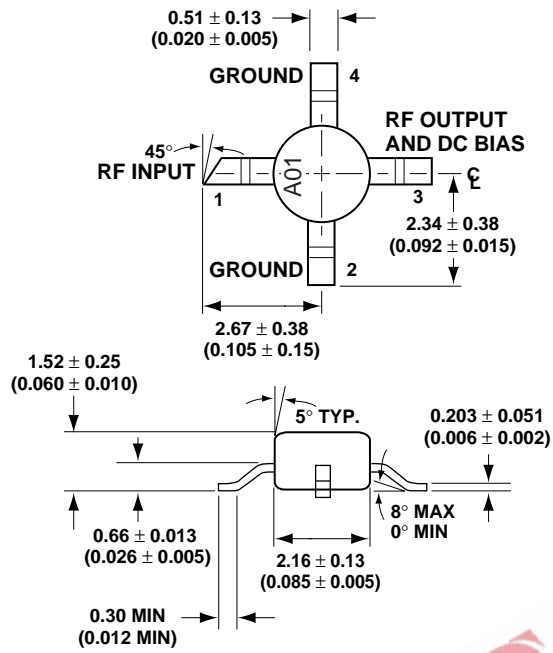

Figure 5. Noise Figure vs. Frequency.

86 Plastic Package Dimensions



DIMENSIONS ARE IN MILLIMETERS (INCHES)

EEPW.com.cn 电子产品世界