

Microstrips .050" Contact Spacing

MT

The Cannon Microstrips provide an extremely dense and reliable interconnection solution in a minimum profile package, giving great application flexibility. Available with latches or guide pins, Microstrips are frequently found in board-to-wire applications where high reliability is a primary concern.

Three termination styles are available: solder cup, pigtail, harness, or printed circuit leads. The MicroPin Contact System assures maximum performance in a minimum package.



Product Features

- High Performance MicroPin Contact System
- High-density .050" contact spacing
- Pre-wired for ease of installation
- Fully potted wire terminations
- Guide pins for alignment and polarizing
- Quick-disconnect latches
- 3 Amp current rating
- Precision crimp terminations
- Solder cup, pigtail or printed circuit terminations
- Surface mount leads

MicroPin Contact System

The Cannon MicroPin Contact System offers uncompromised performance in downsized interconnects. The beryllium copper pin contact is fully recessed in the insulator, assuring positive contact alignment and robust performance. The socket contact is precision machined from high strength copper alloy and features a smooth lead-in chamfer.

The MicroPin features seven points of electrical contact. This contact system assures high normal force, excellent wipe and superior shock and vibration performance.

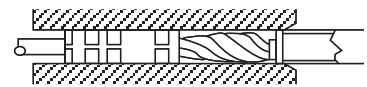
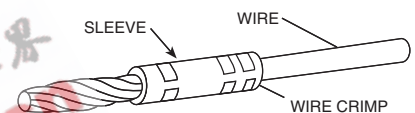

Specifications

Current Rating	3 Amps max
Dielectric Withstanding Voltage	900 VAC @ sea level; 300 VAC @ 70,000 feet altitude
Insulation Resistance	5000 megohms min.
Contact Resistance	8 milliohms max.
Operating Temperature	MTV polyester -56°C to +125°C; MTB diallyl phthalate -55°C to +150°C
Durability	500 cycles min.
Shock/Vibration	50 G's/20 G's
Connector Mating Force	(8 oz.) x (# of contacts)
Latch Retention	5 lbs. min.
Wire Size	#26 AWG insulated wire, #25 AWG uninsulated solid wire. MT strips will also accommodate #24 AWG through #32 AWG. For other wiring options contact the factory for ordering information.
	General Performance requirements in accordance with MIL-DTL-83513

Materials and Finishes

Insulator	MTV: Glass-filled polyester per MIL-M-24519; MTB: Glass-filled diallyl phthalate per MIL-M-14
Contact	Copper Alloy per MIL-C-83513
Contact Finish	50 Microinches Min. Gold Plated per MIL-G-45204
Insulated Wire	#26 AWG. 19/38 Stranded, silver-plated copper, TFE Teflon insulation per MIL-W-16878/4
Uninsulated Solid Wire	#25 AWG gold-plated copper per QQ-W-343
Potting Material/Contact Encapsulant	Epoxy
Latch	300 series stainless steel, passivated



Dimensions shown in inch (mm)
Specifications and dimensions subject to change

www.ittcannon.com

Microstrips .050" Contact Spacing

MT

How to Order

R MTV1 - 16 P H001 01

RoHS Compliance  _____

Series _____

MTB1 – High Temperature Dialyl Phthalate 150°C (Recommended for severe environments)
 MTV1 – Polyester 125°C (Recommended for general purpose use)

Number of Cavities _____

2 through 40.
 This number is the total number of cavities including guide pins and latches. 40 positions is the maximum recommended size for standard strips, but sizes up to 120 positions are available on request.

Contact Type _____

P- Pin
 S – Socket

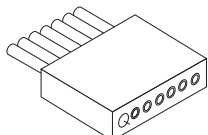

Pin Strip

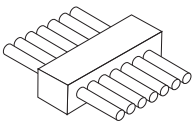

Socket Strip

Termination Style _____

Solder Cup contacts for customer termination
 S

Pre-wired Pigtails
 H067 – Pre-wired pigtail with 18" of insulated Teflon wire per M22759/11, #26 AWG, 19 strand, yellow
 HY01 – Pre-wired pigtail with 18" of insulated Teflon wire per M22759/11, #26 AWG, 19 strand, 10 color repeating

Straight Terminals .018" diameter, gold-plated
 L1 – 5" extension
 L2 – 1" extension
 L57 – .190" extension
 L61 – .125" extension



Right Angle Terminals staggered footprint .018" diameter, gold plated
 AL57 – .190" extension
 AL61 – .125" extension

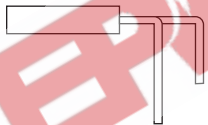

Right Angle Terminals .050" in-line footprint .018" diameter, gold plated
 BL57 – .190" extension
 BL61 – .125" extension

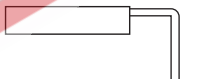

Surface Mount .018" diameter, gold-plated
 CL1



Guide Pin and Latch Options

- 01 – Guide pin installed in end cavities of socket strip. Blank holes in end cavities of pin strip.
- 02 – Guide pin installed in cavity #1 of socket Strip. Blank holes in cavity #1 of pin strip.
- 03 – Spring latches installed in end cavities of socket strip. Latch clips installed in end cavities of pin strip. For use with MTV1 only.
- 04 – Spring latch installed in center cavity of socket strip. Spring latch installed in center cavity of pin strip. For use with MTV1 only.

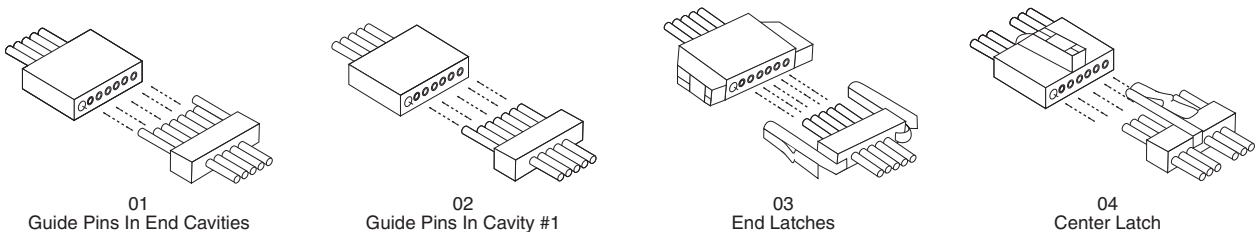

Dimensions shown in inch (mm)
 Specifications and dimensions subject to change

www.ittcannon.com



Microstrips .050" Contact Spacing

MT

Connector Weights

Contact (with std. 1/2" copper pigtailed)			.040 gms.
	MTB	pin	.021 gms.
Insulator (per contact cavity)	MTV	socket	.006 gms.
		pin	.014 gms.
		socket	.004 gms.
Guide Post	Stainless		
	Steel		.035 gms.
Latch	Male		.035 gms.
	Female		.074 gms.

Terminal Dimensions

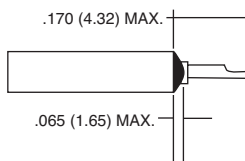

Solder Cup

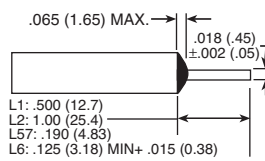

Straight Terminals

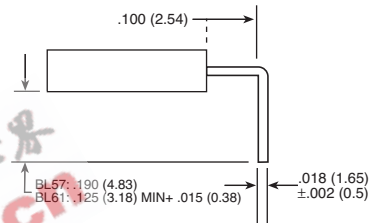

Right Angle Terminals
.050" Centers

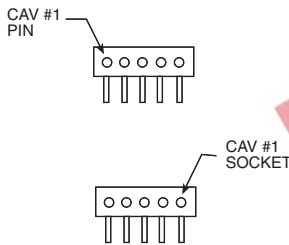

Right Angle Terminals
.100" Spacing Staggered

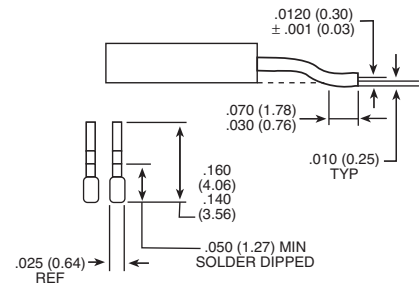
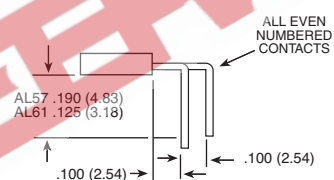

Surface Mount Terminals



Dimensions shown in inch (mm)
Specifications and dimensions subject to change

www.ittcannon.com

Latch Dimensions

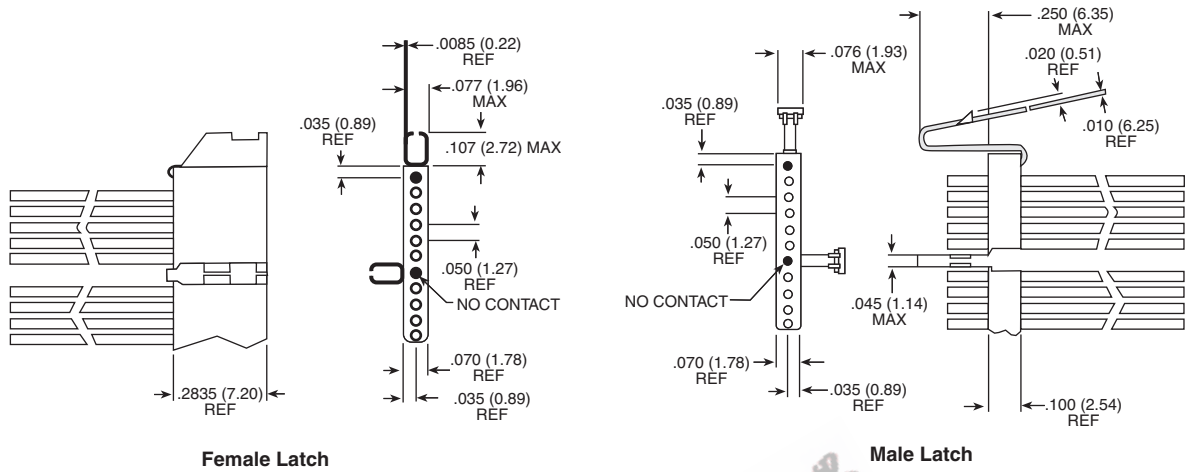

Guide Pin Dimensions

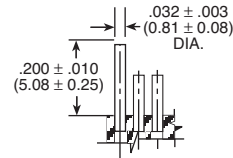

Standard Wire Termination Codes

The following termination codes are listed for your information. For additional codes please refer to Appendix on page 79 and 81. **All wire lengths are minimum.**

Harness Type - (H)

#26 AWG per MIL-W-16878 Type E; Teflon Stranded

Length	All Yellow	Color Coded
3 (76.2)	H020	H027
6 (152.4)	H019	H016
8 (203.2)	H026	H034
10 (254.0)	H029	H025
12 (304.8)	H028	H002
18 (457.2)	H001	H003
20 (508.0)	H033	H023
24 (609.6)	H009	H004
30 (762.0)	H010	H005
36 (914.4)	H011	H006
48 (1219.2)	H013	H048
72 (1828.5)	H017	H046
120 (3048.0)	H042	H041

Solid Uninsulated Type - (L)

#25 AWG Gold Plated Copper

Termination Code	Length
L61	.125 (3.18)
L56	.150 (3.81)
L57	.190 (4.83)
L39	.250 (6.35)
L58	.375 (9.52)
L1	.500 (12.70)
L14	.750 (19.05)
L2	1.000 (25.40)
L7	1.500 (38.10)
L6	2.000 (50.80)
L16	2.500 (63.50)
L10	3.000 (76.20)

Dimensions shown in inch (mm)

Specifications and dimensions subject to change

www.ittcannon.com



Microminiature Strip - .100/.050" Contact Spacing

MT

Polarization



Modification code "-01" in the part number refers to guide posts located on both ends of the socket side of the 50-MIL STRIP connector and empty cavities on the pin side to accept the guide posts.

Although in many cases it is not necessary to polarize 50-MIL STRIP connectors, there are several ways to prevent cross plugging. One method is the use of guide posts that can be located in specified cavities to assure that the contacts will align when these post are positioned before mating.

MTB1 and MTV1 - .050 (1.27) Contact Centers

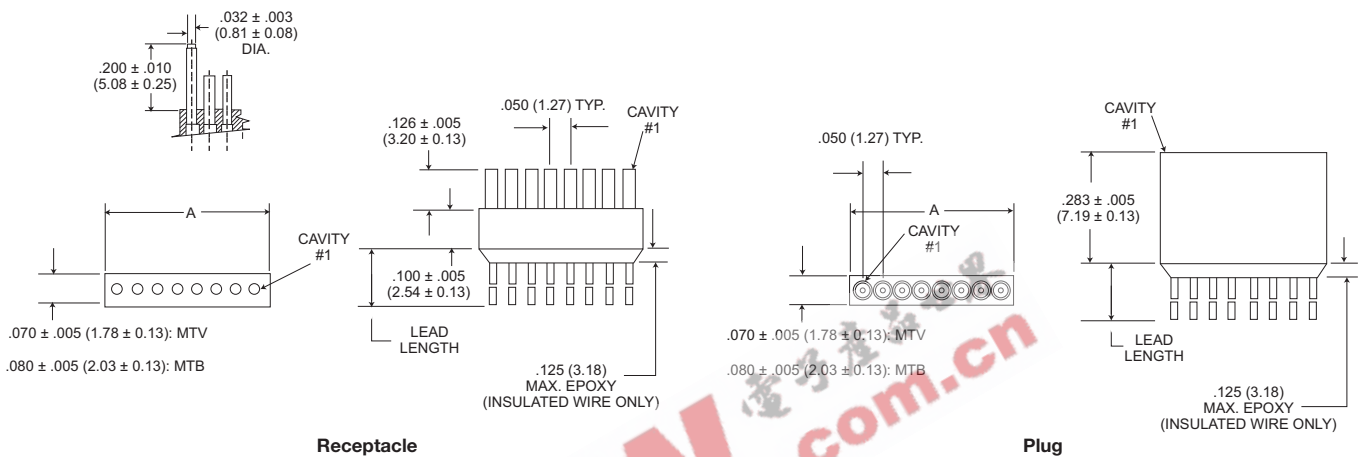

Part Number by Size	A ±.015 (0.38)	Part Number by Size	A ±.015 (0.38)	Part Number by Size	A ±.015 (0.38)	Part Number by Size	A ±.015 (0.38)	Part Number by Size	A ±.015 (0.38)	Part Number by Size	A ±.015 (0.38)
MT*1-1**	.070 (1.78)	MT*1-21**	1.070 (27.18)	MT*1-41**	2.070 (52.58)	MT*1-61**	3.070 (77.98)	MT*1-81**	4.070 (103.38)	MT*1-101**	5.070 (128.78)
MT*1-2**	.120 (3.05)	MT*1-22**	1.120 (28.45)	MT*1-42**	2.120 (53.85)	MT*1-62**	3.120 (79.25)	MT*1-82**	4.120 (104.65)	MT*1-102**	5.120 (130.05)
MT*1-3**	.170 (4.32)	MT*1-23**	1.170 (29.72)	MT*1-43**	2.170 (55.12)	MT*1-63**	3.170 (80.52)	MT*1-83**	4.170 (105.92)	MT*1-103**	5.170 (131.32)
MT*1-4**	.220 (5.59)	MT*1-24**	1.220 (30.99)	MT*1-44**	2.220 (56.39)	MT*1-64**	3.220 (81.79)	MT*1-84**	4.220 (107.19)	MT*1-104**	5.220 (132.59)
MT*1-5**	.270 (6.85)	MT*1-25**	1.270 (32.36)	MT*1-45**	2.270 (57.66)	MT*1-65**	3.270 (83.06)	MT*1-85**	4.270 (108.46)	MT*1-105**	5.270 (133.86)
MT*1-6**	.320 (8.13)	MT*1-26**	1.320 (33.53)	MT*1-46**	2.320 (58.93)	MT*1-66**	3.320 (84.33)	MT*1-86**	4.320 (109.73)	MT*1-106**	5.320 (135.13)
MT*1-7**	.370 (9.40)	MT*1-27**	1.370 (34.80)	MT*1-47**	2.370 (60.20)	MT*1-67**	3.370 (85.60)	MT*1-87**	4.370 (111.00)	MT*1-107**	5.370 (136.40)
MT*1-8**	.420 (10.67)	MT*1-28**	1.420 (36.07)	MT*1-48**	2.420 (61.47)	MT*1-68**	3.420 (86.87)	MT*1-88**	4.420 (112.27)	MT*1-108**	5.420 (137.67)
MT*1-9**	.470 (11.94)	MT*1-29**	1.470 (37.34)	MT*1-49**	2.470 (62.74)	MT*1-69**	3.470 (88.14)	MT*1-89**	4.470 (113.54)	MT*1-109**	5.470 (138.94)
MT*1-10**	.520 (13.20)	MT*1-30**	1.520 (38.61)	MT*1-50**	2.520 (64.01)	MT*1-70**	3.520 (89.41)	MT*1-90**	4.520 (114.81)	MT*1-110**	5.520 (140.21)
MT*1-11**	.570 (14.48)	MT*1-31**	1.570 (39.88)	MT*1-51**	2.570 (65.28)	MT*1-71**	3.570 (90.68)	MT*1-91**	4.570 (116.08)	MT*1-111**	5.570 (141.48)
MT*1-12**	.620 (15.75)	MT*1-32**	1.620 (41.15)	MT*1-52**	2.620 (66.55)	MT*1-72**	3.620 (91.95)	MT*1-92**	4.620 (117.35)	MT*1-112**	5.620 (142.75)
MT*1-13**	.670 (17.02)	MT*1-33**	1.670 (42.42)	MT*1-53**	2.670 (67.82)	MT*1-73**	3.670 (93.22)	MT*1-93**	4.670 (118.62)	MT*1-113**	5.670 (144.02)
MT*1-14**	.720 (18.29)	MT*1-34**	1.720 (43.69)	MT*1-54**	2.720 (69.09)	MT*1-74**	3.720 (94.49)	MT*1-94**	4.720 (119.89)	MT*1-114**	5.720 (145.29)
MT*1-15**	.770 (19.56)	MT*1-35**	1.770 (44.96)	MT*1-55**	2.770 (70.36)	MT*1-75**	3.770 (95.76)	MT*1-95**	4.770 (121.16)	MT*1-115**	5.770 (146.56)
MT*1-16**	.820 (20.83)	MT*1-36**	1.820 (46.23)	MT*1-56**	2.820 (71.63)	MT*1-76**	3.820 (97.03)	MT*1-96**	4.820 (122.43)	MT*1-116**	5.820 (147.83)
MT*1-17**	.870 (22.10)	MT*1-37**	1.870 (47.50)	MT*1-57**	2.870 (72.90)	MT*1-77**	3.870 (98.30)	MT*1-97**	4.870 (123.70)	MT*1-117**	5.870 (149.10)
MT*1-18**	.920 (23.37)	MT*1-38**	1.920 (48.77)	MT*1-58**	2.920 (74.17)	MT*1-78**	3.920 (99.57)	MT*1-98**	4.920 (124.97)	MT*1-118**	5.920 (150.37)
MT*1-19**	.970 (24.64)	MT*1-39**	1.970 (50.04)	MT*1-59**	2.970 (75.44)	MT*1-79**	3.970 (100.84)	MT*1-99**	4.970 (126.24)	MT*1-119**	5.970 (151.64)
MT*1-20**	1.020 (25.91)	MT*1-40**	2.020 (51.31)	MT*1-60**	3.020 (76.71)	MT*1-80**	4.020 (102.11)	MT*1-100**	5.020 (127.50)	MT*1-120**	6.020 (152.91)

NOTE: MTB1 available in up to 120 contacts.



Dimensions shown in inch (mm)
Specifications and dimensions subject to change

www.ittcannon.com

Microminiature Strip - .100/.050" Contact Spacing

MT

MTB2 and MTV2 - .100 (2.54) Contact Centers

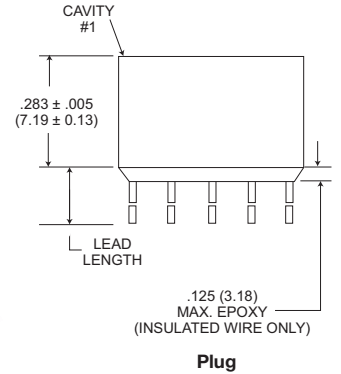
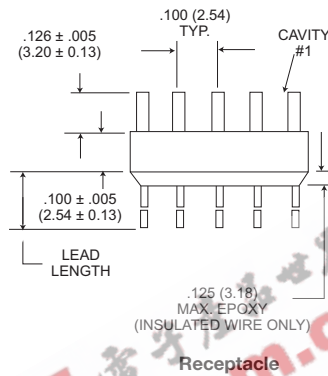
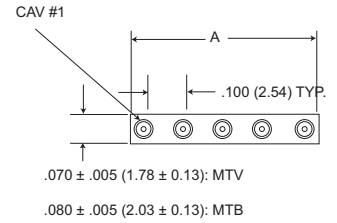
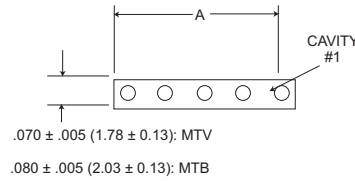
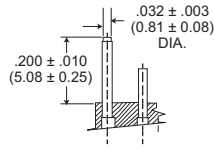

Part Number by Size	A ±.015 (0.38)	Part Number by Size	A ±.015 (0.38)
MT*2-1**	.070 (1.78)	MT*2-31**	3.070 (77.98)
MT*2-2**	.170 (4.32)	MT*2-32**	3.170 (80.52)
MT*2-3**	.270 (6.86)	MT*2-33**	3.270 (83.06)
MT*2-4**	.370 (9.40)	MT*2-34**	3.370 (85.60)
MT*2-5**	.470 (11.94)	MT*2-35**	3.470 (88.14)
MT*2-6**	.570 (14.48)	MT*2-36**	3.570 (90.68)
MT*2-7**	.670 (17.02)	MT*2-37**	3.670 (93.22)
MT*2-8**	.770 (19.56)	MT*2-38**	3.770 (95.76)
MT*2-9**	.870 (22.10)	MT*2-39**	3.870 (98.30)
MT*2-10**	.970 (24.64)	MT*2-40**	3.970 (100.84)
MT*2-11**	1.070 (27.18)	MT*2-41**	4.070 (103.38)
MT*2-12**	1.170 (29.72)	MT*2-42**	4.170 (105.92)
MT*2-13**	1.270 (32.26)	MT*2-43**	4.270 (108.46)
MT*2-14**	1.370 (34.80)	MT*2-44**	4.370 (111.00)
MT*2-15**	1.470 (37.34)	MT*2-45**	4.470 (113.54)
MT*2-16**	1.570 (39.88)	MT*2-46**	4.570 (116.08)
MT*2-17**	1.670 (42.42)	MT*2-47**	4.670 (118.62)
MT*2-18**	1.770 (44.96)	MT*2-48**	4.770 (121.16)
MT*2-19**	1.870 (47.50)	MT*2-49**	4.870 (123.70)
MT*2-20**	1.970 (50.04)	MT*2-50**	4.970 (126.24)
MT*2-21**	2.070 (52.58)	MT*2-51**	5.070 (128.78)
MT*2-22**	2.170 (55.12)	MT*2-52**	5.170 (131.32)
MT*2-23**	2.270 (57.66)	MT*2-53**	5.270 (133.86)
MT*2-24**	2.370 (60.20)	MT*2-54**	5.370 (136.40)
MT*2-25**	2.470 (62.74)	MT*2-55**	5.470 (138.94)
MT*2-26**	2.570 (65.28)	MT*2-56**	5.570 (141.48)
MT*2-27**	2.670 (67.82)	MT*2-57**	5.670 (144.02)
MT*2-28**	2.770 (70.36)	MT*2-58**	5.770 (146.56)
MT*2-29**	2.870 (72.90)	MT*2-59**	5.870 (149.10)
MT*2-30**	2.970 (75.44)	MT*2-60**	5.970 (151.64)

Dimensions shown in inch (mm)
Specifications and dimensions subject to change

www.ittcannon.com

